

VARIABLE GAIN AMPLIFIER FOR TRANSMITTER AGC

DESCRIPTION

The μPC8204TK is a silicon monolithic integrated circuit designed as variable gain amplifier. The package is 6-pin lead-less minimold suitable for surface mount.

This IC is manufactured using our 30 GHz f_{max} UHS0 (Ultra High Speed Process) silicon bipolar process.

This IC is as same circuit current as conventional μPC8119T and μPC8120T, but operates at higher frequency and wider gain control range.

FEATURES

- Gain control range : GCR = 40 dB TYP. @ f = 1.9 GHz
: GCR = 40 dB TYP. @ f = 2.4 GHz
- Maximum power gain : G_{PMAX} = 14.5 dB TYP. @ f = 1.9 GHz
: G_{PMAX} = 14.0 dB TYP. @ f = 2.4 GHz
- Operating frequency : f_{in} = 0.8 to 2.5 GHz
- Supply voltage : V_{CC} = 2.7 to 3.3 V
- High-density surface mounting : 6-pin lead-less minimold package

APPLICATION

- 0.8 to 2.5 GHz transmitter/receiver system (PHS, WLAN and so on)

★ ORDERING INFORMATION

Part Number	Order Number	Package	Marking	Supplying Form
μPC8204TK-E2	μPC8204TK-E2-A	6-pin lead-less minimold (1511 PKG) (Pb-Free) ^{Note}	6E	<ul style="list-style-type: none"> • Embossed tape 8 mm wide • Pin 1, 6 face the perforation side of the tape • Qty 5 kpcs/reel

Note With regards to terminal solder (the solder contains lead) plated products (conventionally plated), contact your nearby sales office.

Remark To order evaluation samples, contact your nearby sales office.
Part number for sample order: μPC8204TK

Caution Observe precautions when handling because these devices are sensitive to electrostatic discharge.

The information in this document is subject to change without notice. Before using this document, please confirm that this is the latest version.
Not all devices/types available in every country. Please check with local NEC Compound Semiconductor Devices representative for availability and additional information.

PIN CONNECTIONS

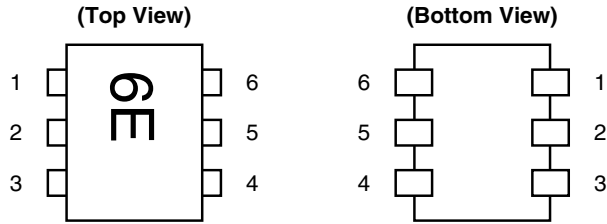

Pin No.	Pin Name
1	INPUT
2	GND
3	GND
4	OUTPUT
5	V _{CC}
6	V _{AGC}

VARIABLE GAIN AMPLIFIER PRODUCT LINE-UP

Parameter Part No.	I _{CC} (mA)	0.95 GHz output port matching frequency			1.44 GHz output port matching frequency			1.9 GHz output port matching frequency			2.4 GHz output port matching frequency		
		G _{PMAX} (dB)	GCR (dB)	NF (dB)	G _{PMAX} (dB)	GCR (dB)	NF (dB)	G _{PMAX} (dB)	GCR (dB)	NF (dB)	G _{PMAX} (dB)	GCR (dB)	NF (dB)
μPC8204TK	11.5	-	-	-	-	-	-	14.5	40	7.5	14.0	40	7.5
μPC8119T	11.0	12.5	50	8.5	13.0	45	7.5	(12.5)	(22)	(7.2)	-	-	-
μPC8120T	11.0	13.0	50	9.0	13.5	45	7.5	(13.0)	(22)	(7.3)	-	-	-

- Remarks 1.** Typical performance. Please refer to **ELECTRICAL CHARACTERISTICS** in detail. (): reference.
2. To know the associated product, please refer to each latest data sheet.

CONTENTS

1. PIN EXPLANATION 4

2. ABSOLUTE MAXIMUM RATINGS..... 5

3. RECOMMENDED OPERATING RANGE 5

4. ELECTRICAL CHARACTERISTICS 5

★ 5. TEST CIRCUITS 6

5.1 f = 1.9 GHz..... 6

5.1.1 Test circuit 1 6

5.1.2 Illustration of the test circuit 1 assembled on evaluation board 6

5.1.3 Component list 6

5.2 f = 2.4 GHz..... 7

5.2.1 Test circuit 2..... 7

5.2.2 Illustration of the test circuit 2 assembled on evaluation board 7

5.2.3 Component list 7

★ 6. TYPICAL CHARACTERISTICS..... 8

6.1 Inductor loading with external bias tee at output port..... 9

6.2 Output port matching at f = 1.9 GHz 10

6.3 Output port matching at f = 2.4 GHz 22

★ 7. PACKAGE DIMENSIONS 31

8. NOTES ON CORRECT USE 32

★ 9. RECOMMENDED SOLDERING CONDITIONS 32

1. PIN EXPLANATION

Pin No.	Pin Name	Applied Voltage (V)	Pin Voltage (V) <small>Note</small>	Function and Applications	Internal Equivalent Circuit
1	INPUT	–	1.2	RF input pin. This pin should be coupled with capacitor (example 100 pF) for DC cut. Input return loss can be improved with external impedance matching circuit.	
2 3	GND	0	–	Ground pin. This pin should be connected to system ground with minimum inductance. Ground pattern on the board should be formed as wide as possible. Ground pins must be connected together with wide ground pattern to decrease impedance difference.	
4	OUTPUT	Voltage as same as V _{cc} through external inductor	–	RF output pin. This pin is de-signed as open collector of high impedance. This pin must be externally equipped with matching circuits.	
5	V _{cc}	2.7 to 3.3	–	Supply voltage pin. This pin must be equipped with bypass capacitor (example 1 000 pF) to minimize its RF impedance.	
6	V _{AGC}	0 to 3.3	–	Gain control pin.	

Note Pin voltage is measured at V_{cc} = 3.0 V

2. ABSOLUTE MAXIMUM RATINGS

Parameter	Symbol	Test Conditions	Ratings	Unit
Supply Voltage	V _{CC}	T _A = +25°C, Pin 4, 5	3.6	V
Total Circuit Current	I _{CC}	T _A = +25°C	30	mA
Gain Control Voltage	V _{AGC}	T _A = +25°C	3.6	V
Power Dissipation	P _D	T _A = +85°C Note	203	mW
Operating Ambient Temperature	T _A		-40 to +85	°C
Storage Temperature	T _{stg}		-55 to +150	°C
Input Power	P _{in}		+5	dBm

Note Mounted on double-sided copper-clad 50 × 50 × 1.6 mm epoxy glass PWB

3. RECOMMENDED OPERATING RANGE

Parameter	Symbol	MIN.	TYP.	MAX.	Unit	Remarks
Supply Voltage	V _{CC}	2.7	3.0	3.3	V	Same voltage should be applied to pin 4 and pin 5.
Operating Ambient Temperature	T _A	-40	+25	+85	°C	
Operating Frequency	f _{in}	0.8	-	2.5	GHz	With external output-matching
Gain Control Voltage	V _{AGC}	0	-	3.3	V	

4. ELECTRICAL CHARACTERISTICS (T_A = +25°C, V_{CC} = V_{out} = 3.0 V, Z_s = Z_L = 50 Ω, external matched output port, unless otherwise specified)

Parameter	Symbol	Test Conditions	MIN.	TYP.	MAX.	Unit
Circuit Current	I _{CC}	No signal	8.5	11.5	15.0	mA
Maximum Power Gain	G _{PMAX}	f = 1.9 GHz, P _{in} = -20 dBm f = 2.4 GHz, P _{in} = -20 dBm	11.5 11.0	14.5 14.0	17.5 17.0	dB
Gain Control Range ^{Note}	GCR	f = 1.9 GHz, P _{in} = -20 dBm f = 2.4 GHz, P _{in} = -20 dBm	35 35	40 40	- -	dB
Gain 1 dB Compression Output Power	P _{O(1 dB)}	f = 1.9 GHz, G _{PMAX} f = 2.4 GHz, G _{PMAX}	+2.0 +2.0	+5.0 +5.0	- -	dBm
Input Return Loss	RL _{in}	f = 1.9 GHz, G _{PMAX} f = 2.4 GHz, G _{PMAX}	8 9	11 13	- -	dB
Isolation	ISL	f = 1.9 GHz, G _{PMAX} f = 2.4 GHz, G _{PMAX}	25 25	30 30	- -	dB
Noise Figure	NF	f = 1.9 GHz, G _{PMAX} f = 2.4 GHz, G _{PMAX}	- -	7.5 7.5	10.0 10.0	dB

Note Gain control range GCR specification : GCR = G_{PMAX} - G_{PMIN} (dB)
Conditions G_{PMAX}@V_{AGC} = V_{CC}, G_{PMIN}@V_{AGC} = 0 V

★ 5. TEST CIRCUITS

5.1 f = 1.9 GHz

5.1.1 Test circuit 1

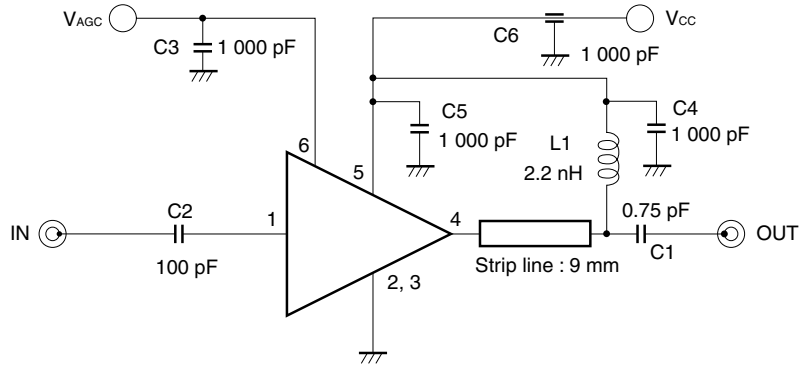

5.1.2 Illustration of the test circuit 1 assembled on evaluation board

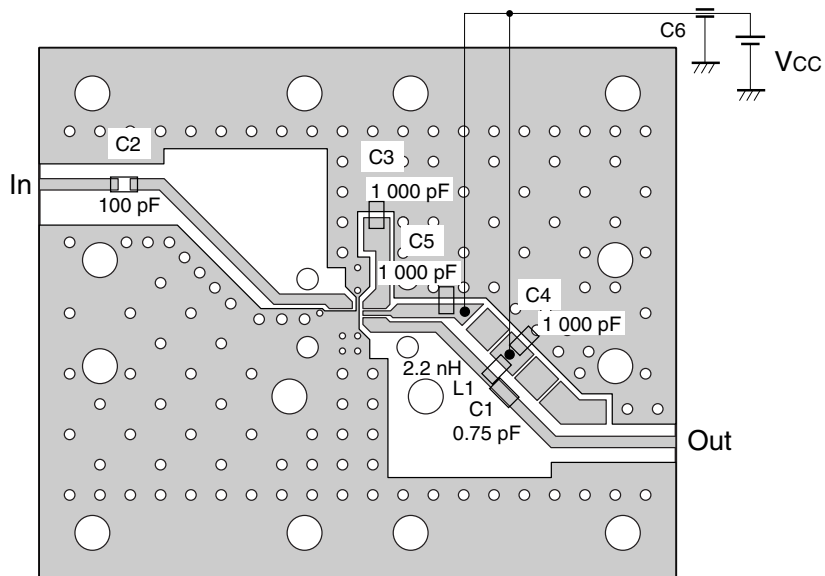

5.1.3 Component list

Symbol	Form	Rating	Part Number	Maker
C1	Chip Capacitor	0.75 pF	GRM39	Murata
C2	Chip Capacitor	100 pF	GRM39	Murata
C3, C4	Chip Capacitor	1 000 pF	GRM39	Murata
C5	Chip Capacitor	1 000 pF	GRM40	Murata
C6	Feed-through Capacitor	1 000 pF	DFT301-801X7R102S50	Murata
L1	Chip Inductor	2.2 nH	LL-2012	TOKO

5.2 f = 2.4 GHz

5.2.1 Test circuit 2

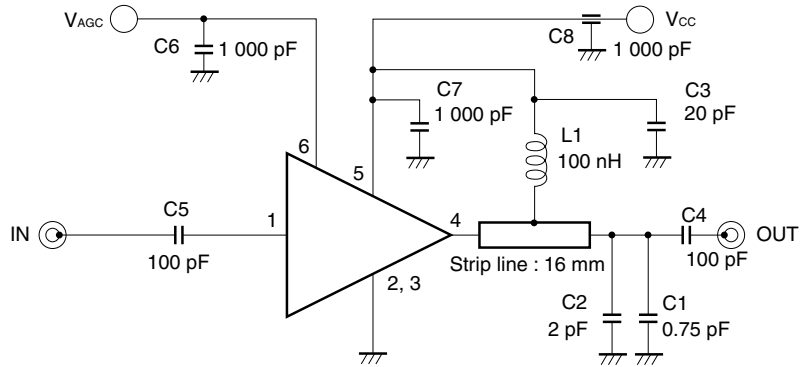

5.2.2 Illustration of the test circuit 2 assembled on evaluation board

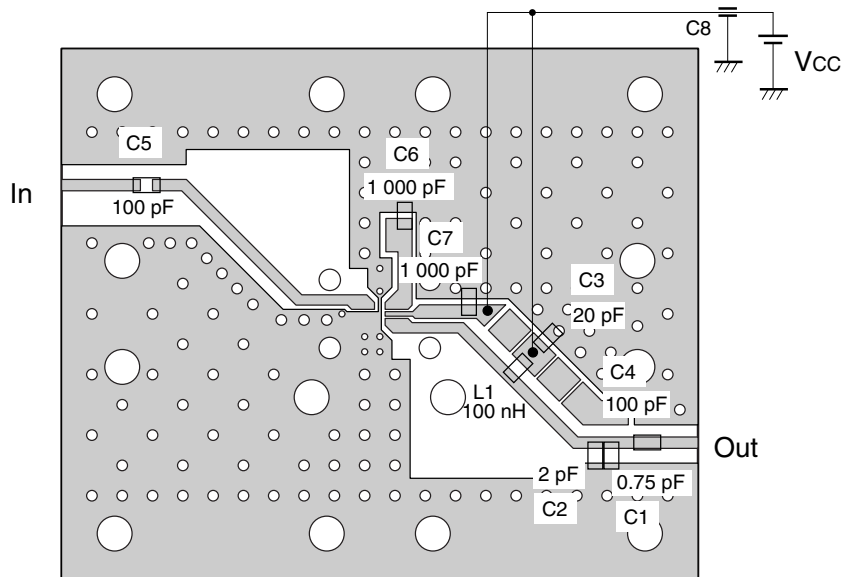

5.2.3 Component list

Symbol	Form	Rating	Part Number	Maker
C1	Chip Capacitor	0.75 pF	GRM39	Murata
C2	Chip Capacitor	2 pF	GRM39	Murata
C3	Chip Capacitor	20 pF	GRM39	Murata
C4, C5	Chip Capacitor	100 pF	GRM39	Murata
C6	Chip Capacitor	1 000 pF	GRM39	Murata
C7	Chip Capacitor	1 000 pF	GRM40	Murata
C8	Feed-through Capacitor	1 000 pF	DFT301-801X7R102S50	Murata
L1	Chip Inductor	100 nH	LL-1608	TOKO

★ 6. TYPICAL CHARACTERISTICS ($T_A = +25^\circ\text{C}$, unless otherwise specified)

CIRCUIT CURRENT vs. SUPPLY VOLTAGE, GAIN CONTROL VOLTAGE

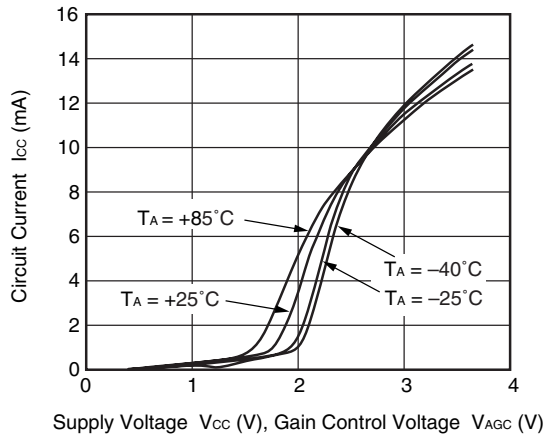

OUT BLOCK CURRENT AND V_{CC} BLOCK CURRENT vs. GAIN CONTROL VOLTAGE

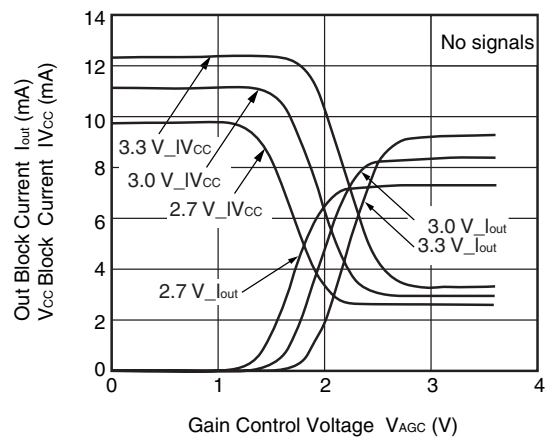

GAIN CONTROL CURRENT vs. GAIN CONTROL VOLTAGE

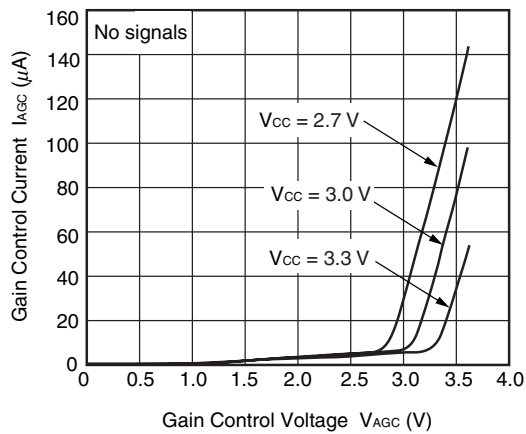

Remark The graphs indicate nominal characteristics.

6.1 Inductor loading with external bias tee at output port

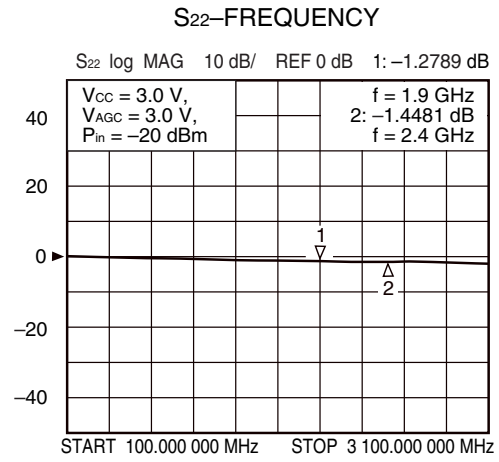
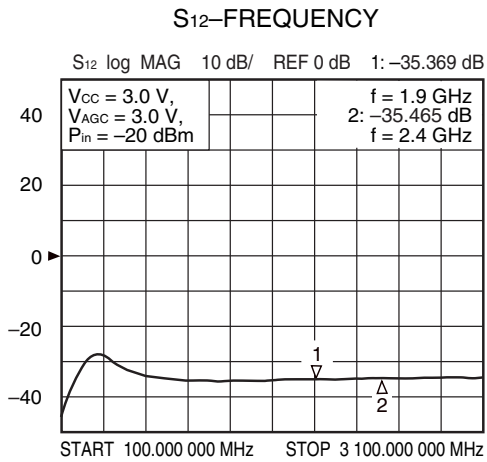
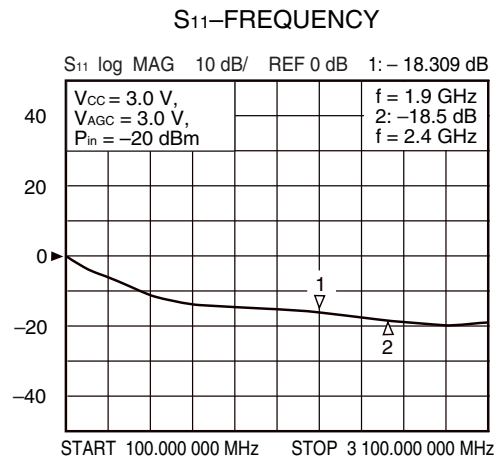
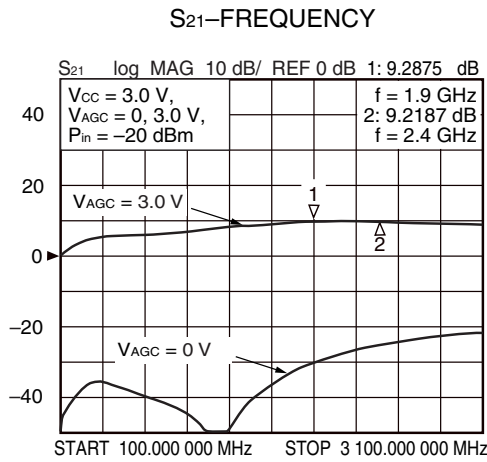
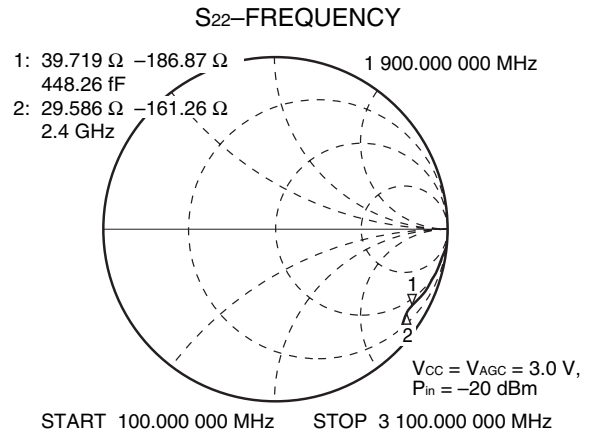
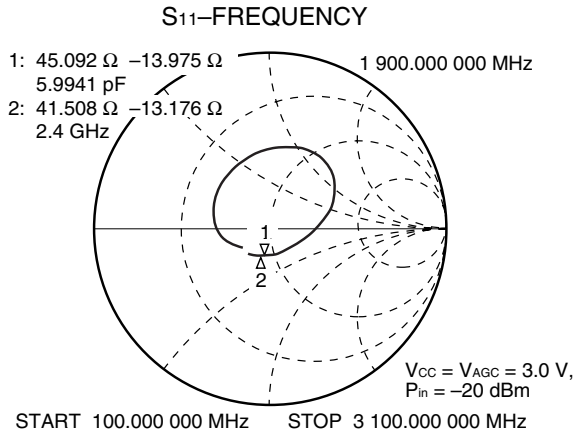

Remark The graphs indicate nominal characteristics.

6.2 Output port matching at f = 1.9 GHz

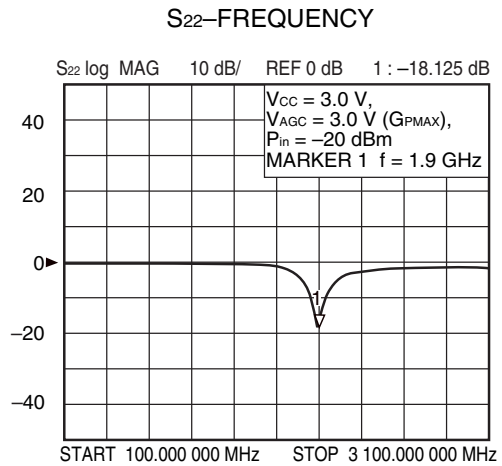
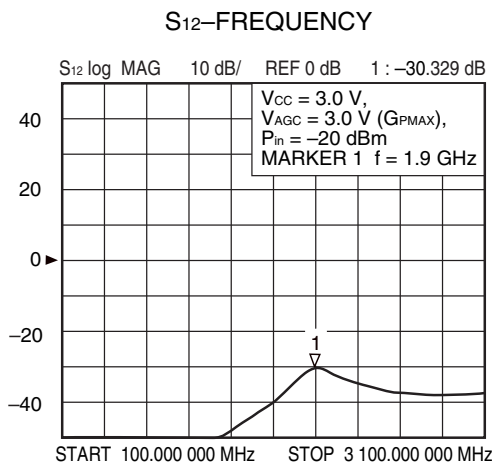
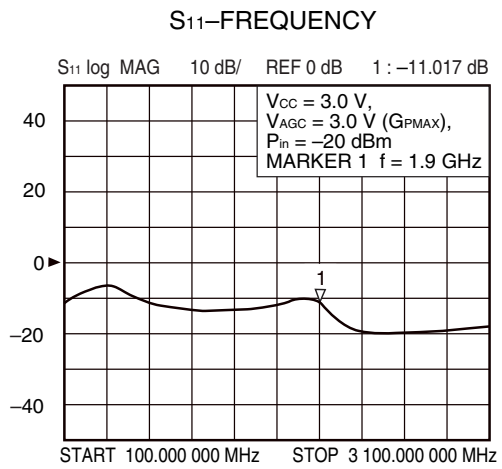
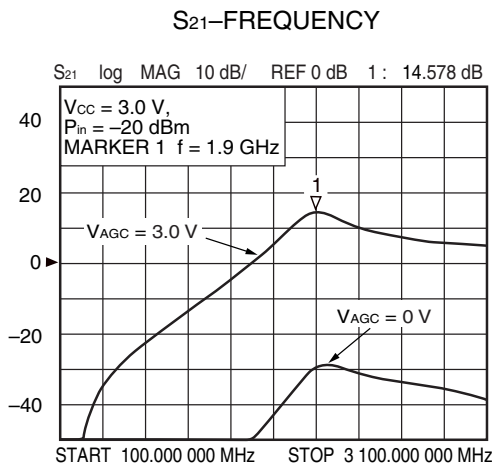
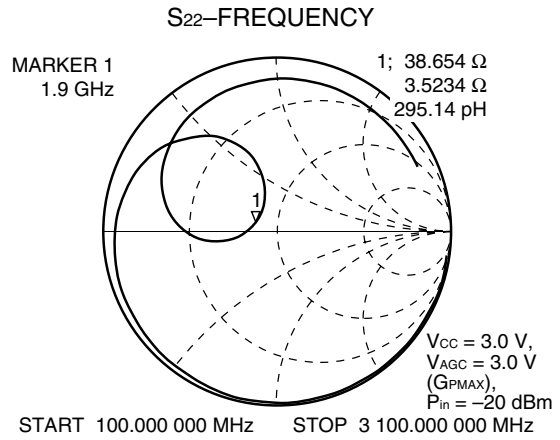
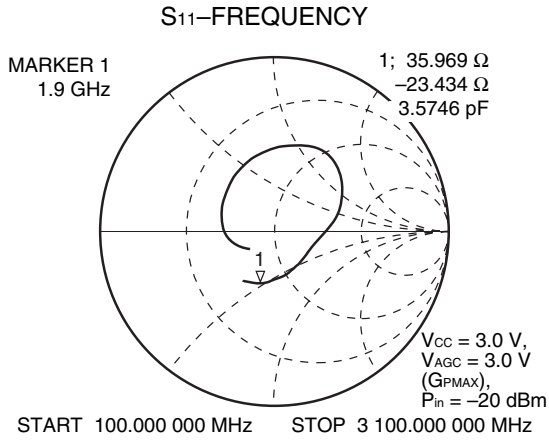

Remark The graphs indicate nominal characteristics.

S₂₁-FREQUENCY

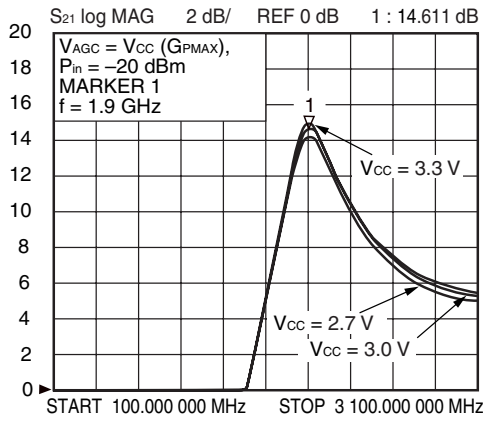

S₁₁-FREQUENCY

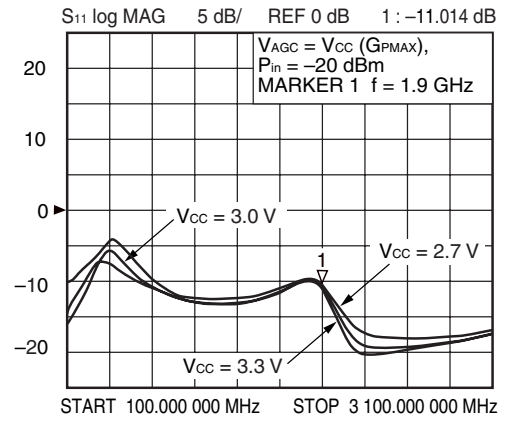

S₁₂-FREQUENCY

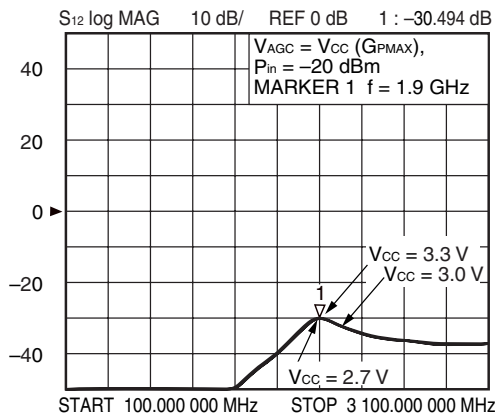

S₂₂-FREQUENCY

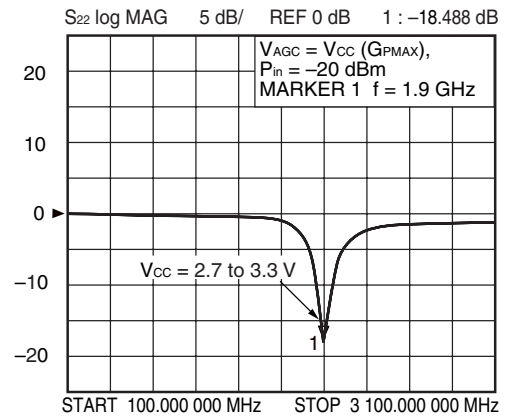

Remark The graphs indicate nominal characteristics.

S₂₁-FREQUENCY

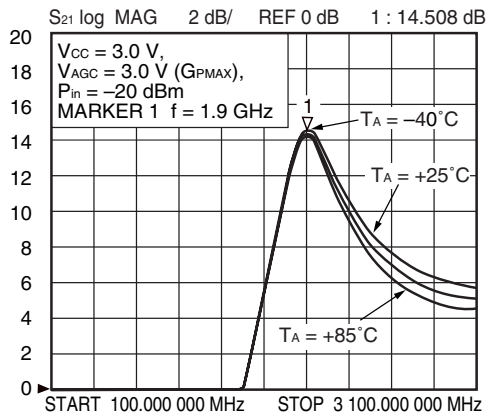

S₁₁-FREQUENCY

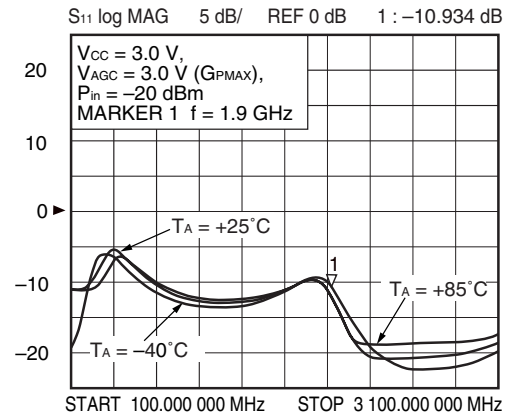

S₁₂-FREQUENCY

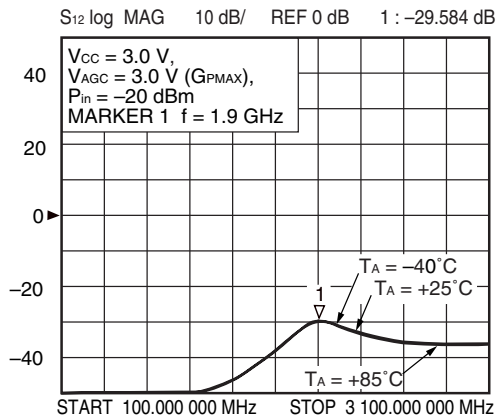

S₂₂-FREQUENCY

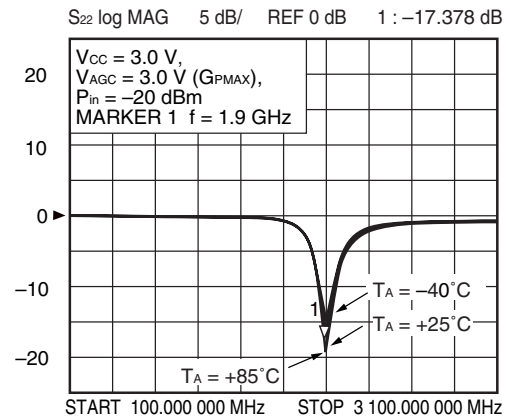

Remark The graphs indicate nominal characteristics.

S₂₁-FREQUENCY

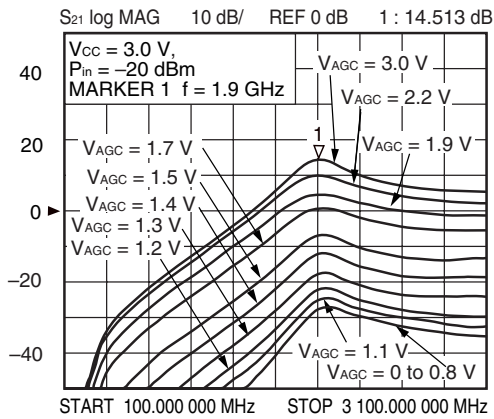

S₁₁-FREQUENCY

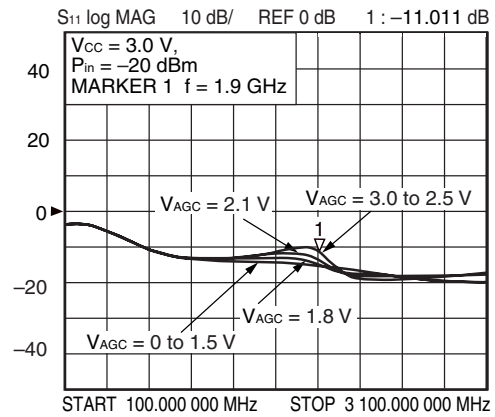

S₁₂-FREQUENCY

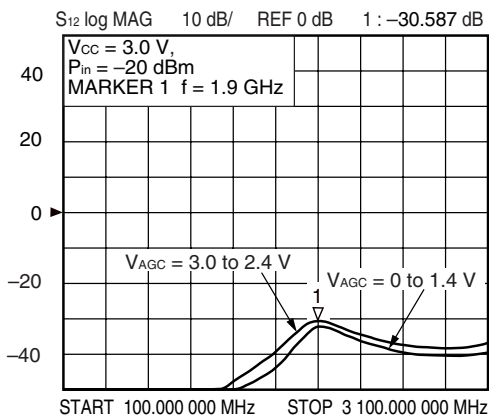

S₂₂-FREQUENCY

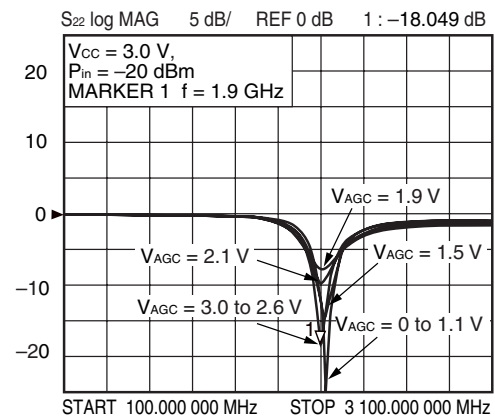

Remark The graphs indicate nominal characteristics.

POWER GAIN vs. GAIN CONTROL VOLTAGE

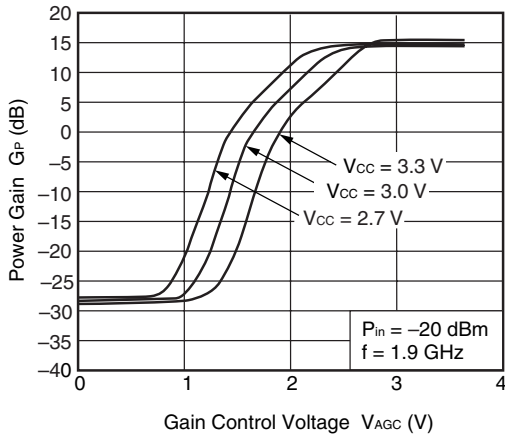

POWER GAIN vs. GAIN CONTROL VOLTAGE

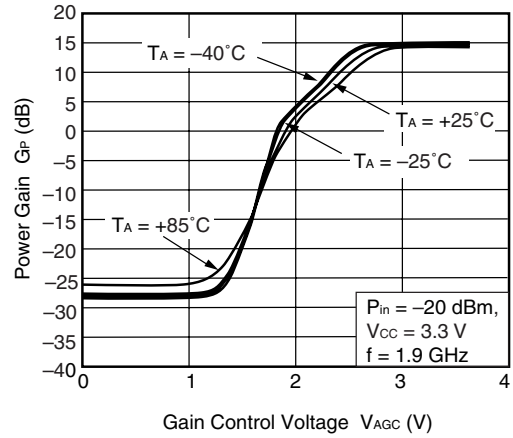

POWER GAIN vs. GAIN CONTROL VOLTAGE

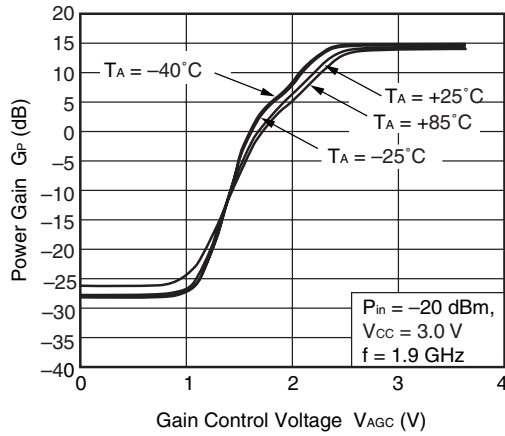

POWER GAIN vs. GAIN CONTROL VOLTAGE

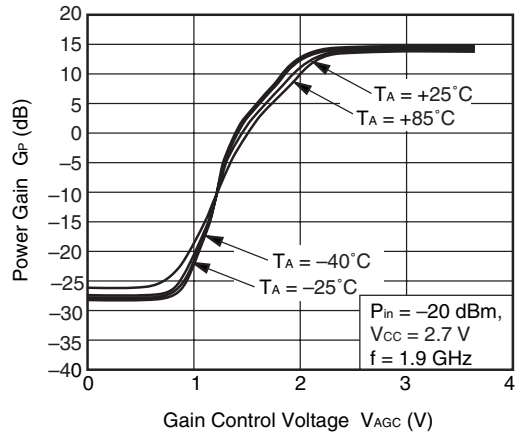

Remark The graphs indicate nominal characteristics.

ADJACENT CHANNEL POWER LEAKAGE, OUTPUT POWER vs. INPUT POWER

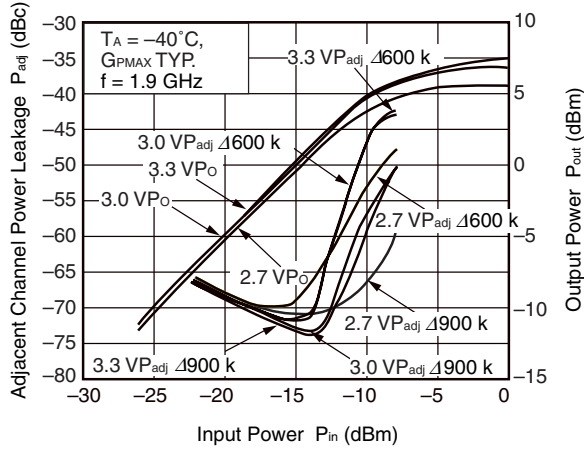

OUTPUT POWER vs. INPUT POWER

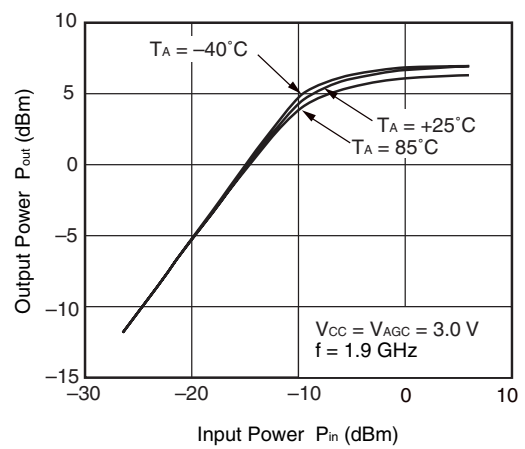

ADJACENT CHANNEL POWER LEAKAGE, OUTPUT POWER vs. INPUT POWER

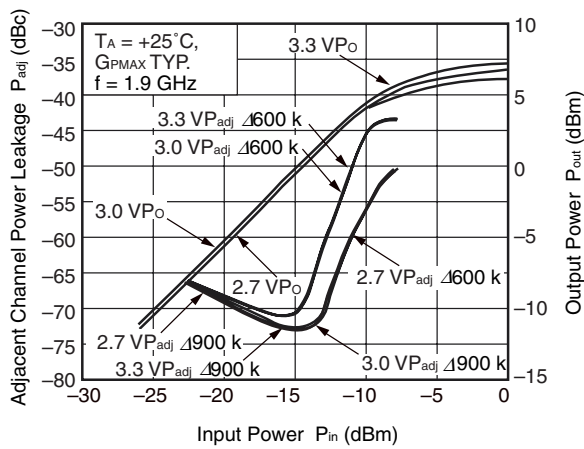

ADJACENT CHANNEL POWER LEAKAGE, OUTPUT POWER vs. INPUT POWER

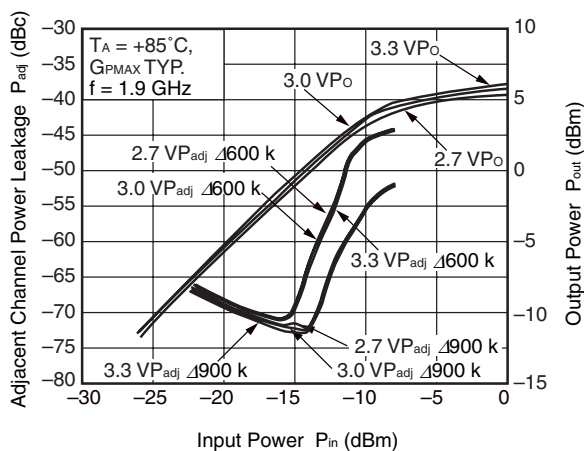

Remark The graphs indicate nominal characteristics.

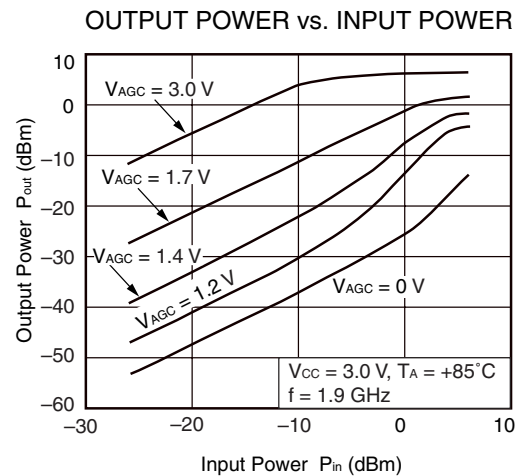
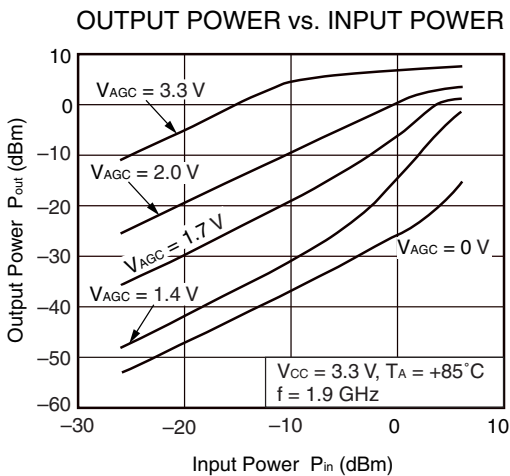
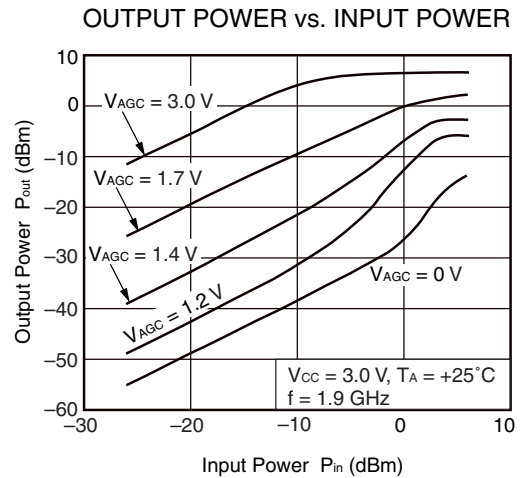
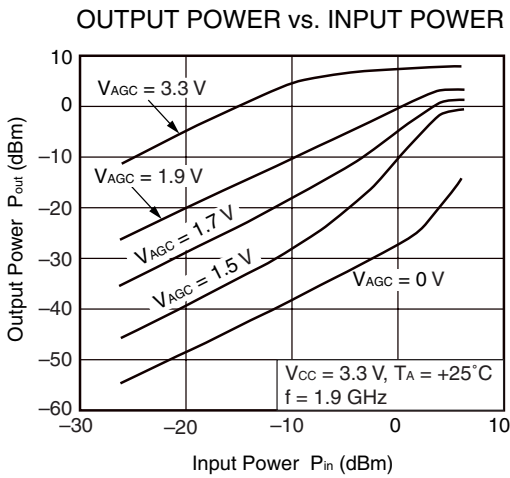
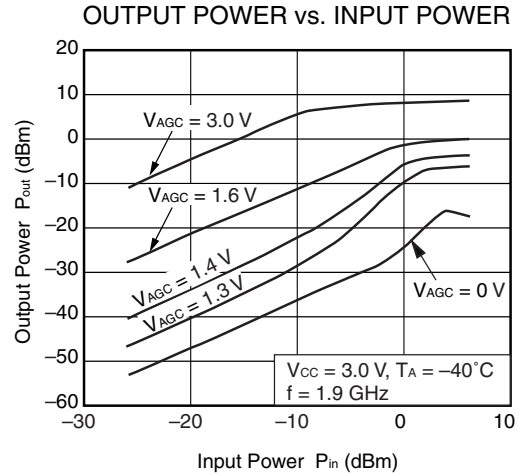
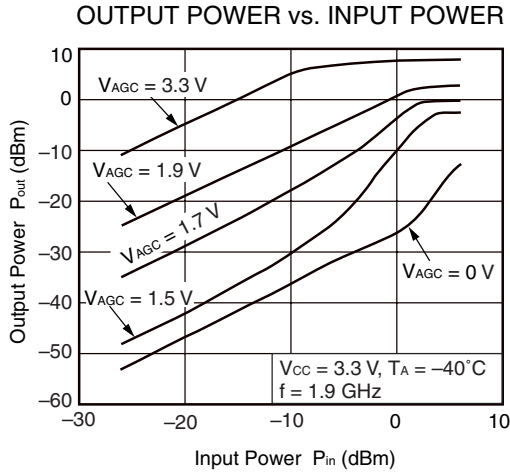

Remark The graphs indicate nominal characteristics.

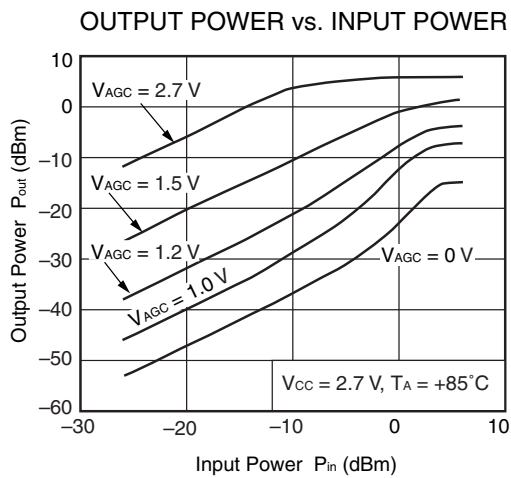
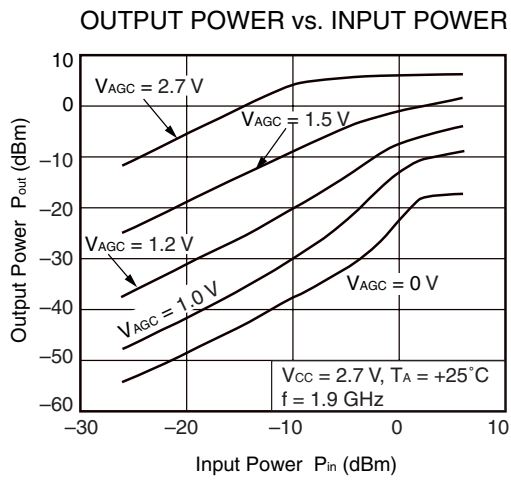
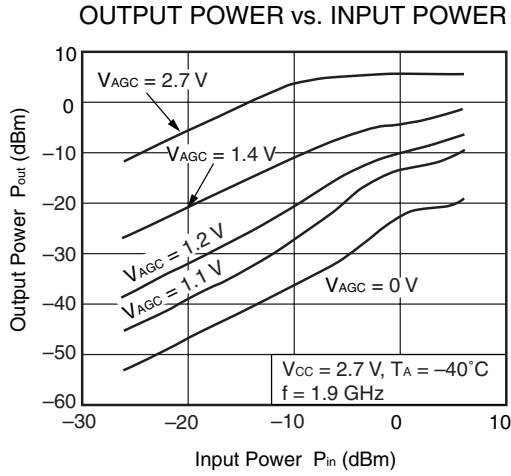

Remark The graphs indicate nominal characteristics.

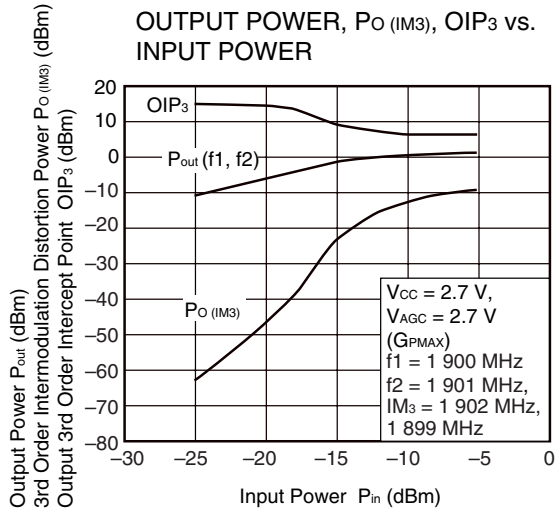
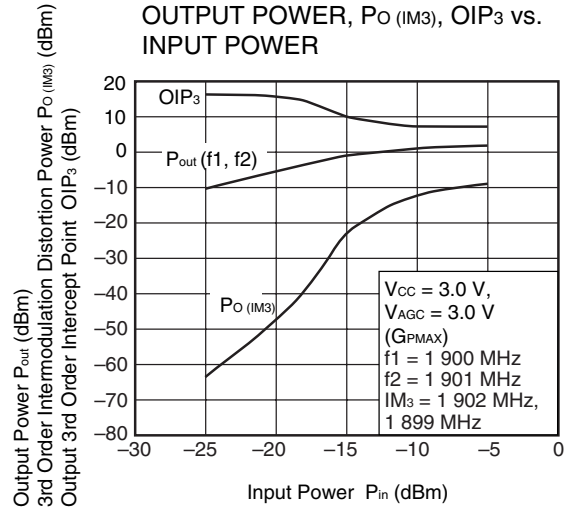
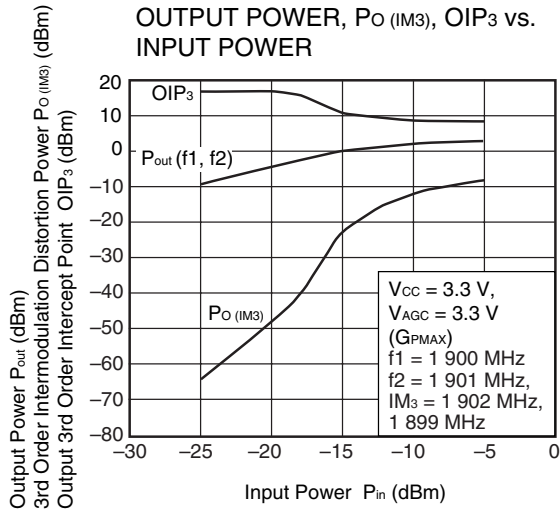

Remark The graphs indicate nominal characteristics.

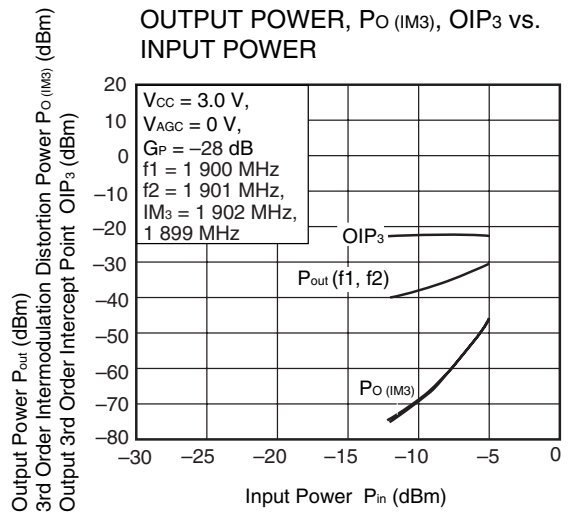
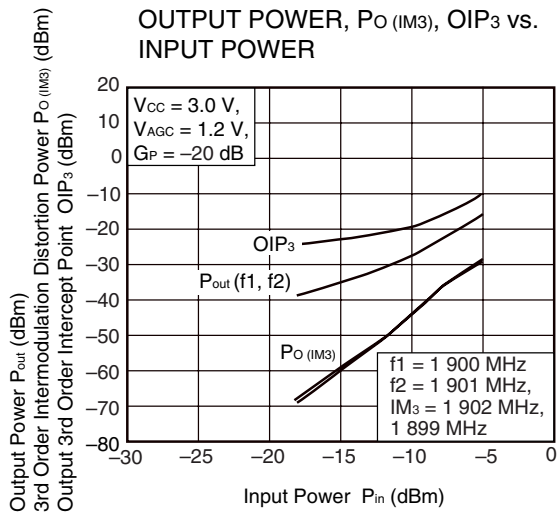
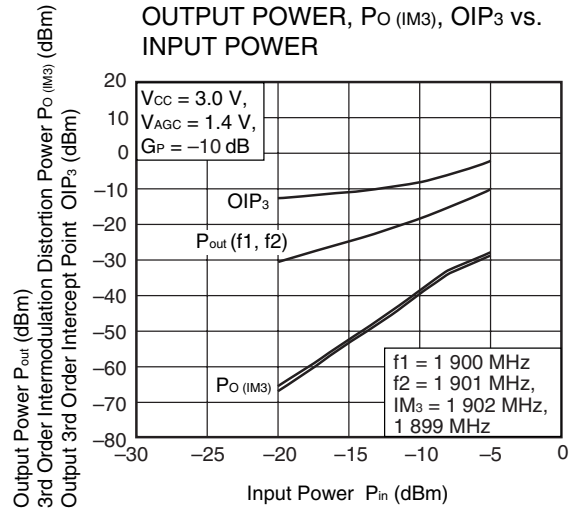
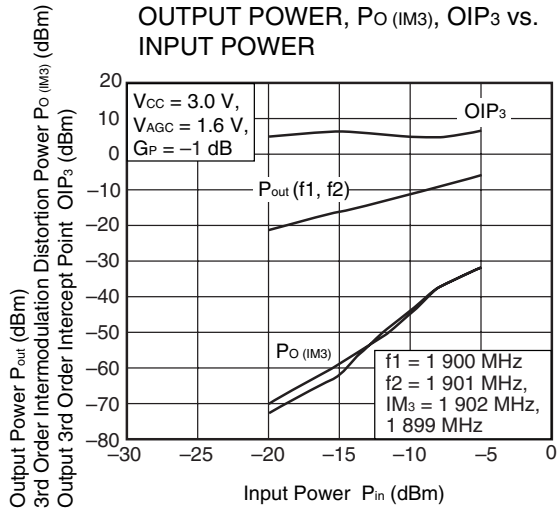

Remark The graphs indicate nominal characteristics.

ADJACENT CHANNEL POWER LEAKAGE, OUTPUT POWER vs. GAIN CONTROL VOLTAGE

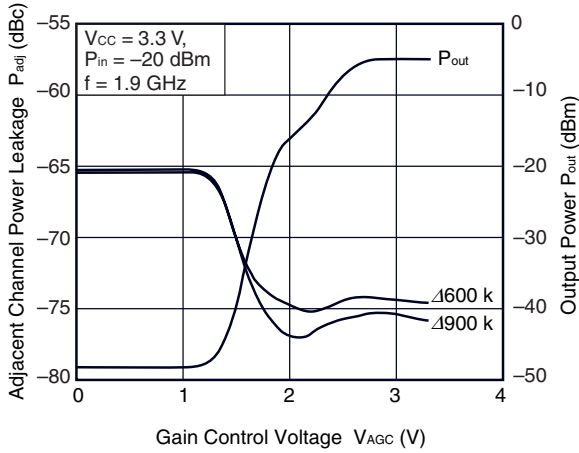

ADJACENT CHANNEL POWER LEAKAGE vs. GAIN CONTROL VOLTAGE

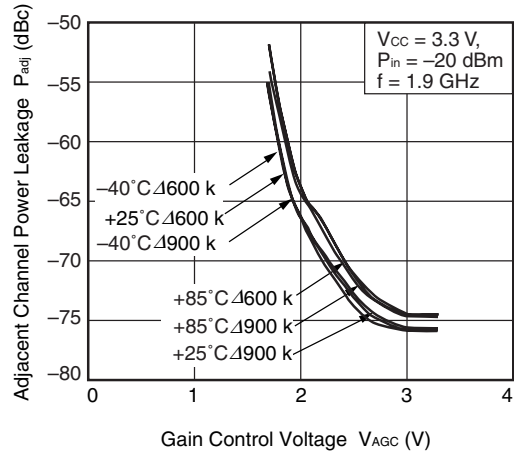

ADJACENT CHANNEL POWER LEAKAGE, OUTPUT POWER vs. GAIN CONTROL VOLTAGE

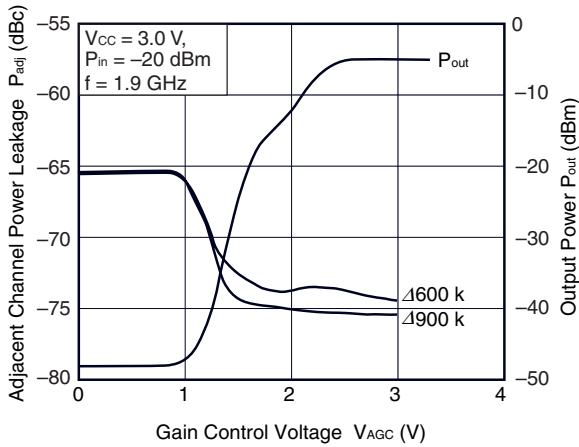

ADJACENT CHANNEL POWER LEAKAGE vs. GAIN CONTROL VOLTAGE

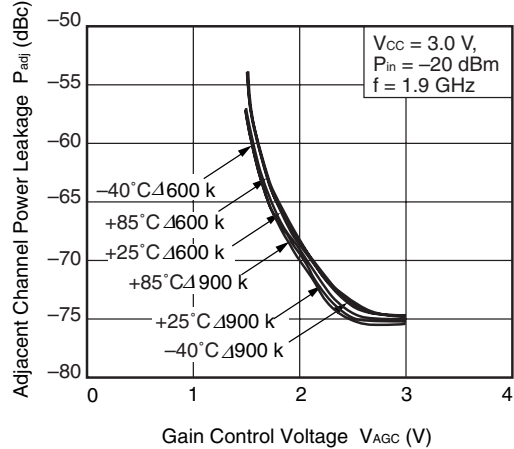

ADJACENT CHANNEL POWER LEAKAGE, OUTPUT POWER vs. GAIN CONTROL VOLTAGE

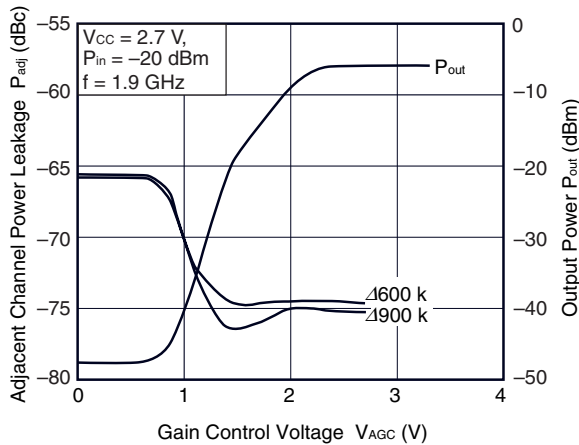

ADJACENT CHANNEL POWER LEAKAGE vs. GAIN CONTROL VOLTAGE

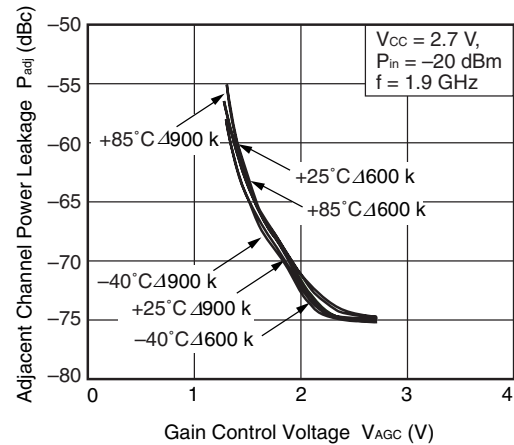

Remark The graphs indicate nominal characteristics.

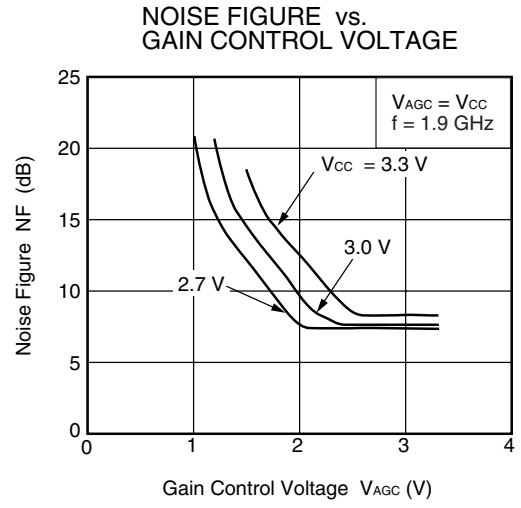
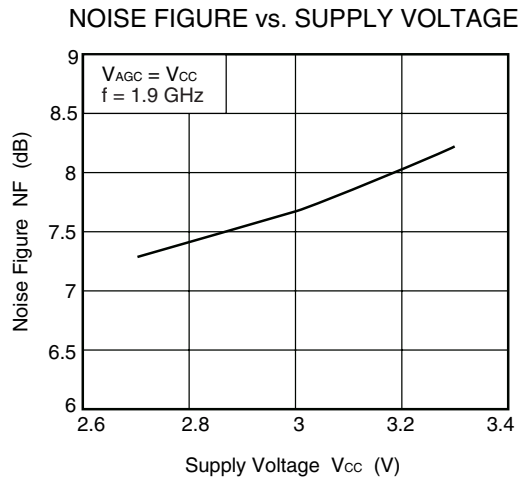

Remark The graphs indicate nominal characteristics.

6.3 Output port matching at f = 2.4 GHz

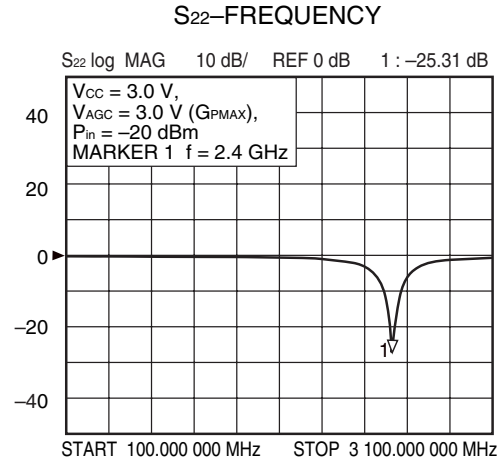
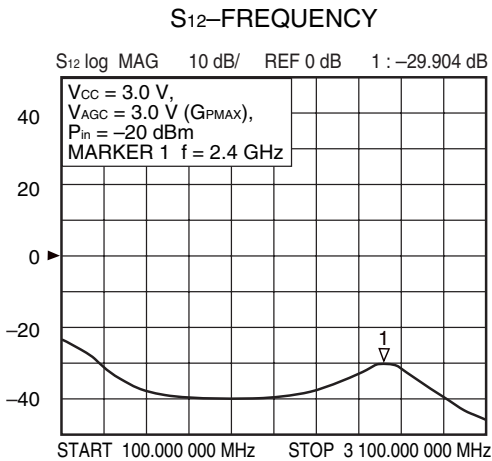
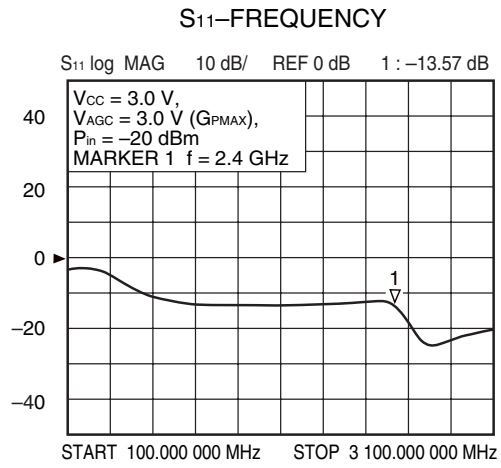
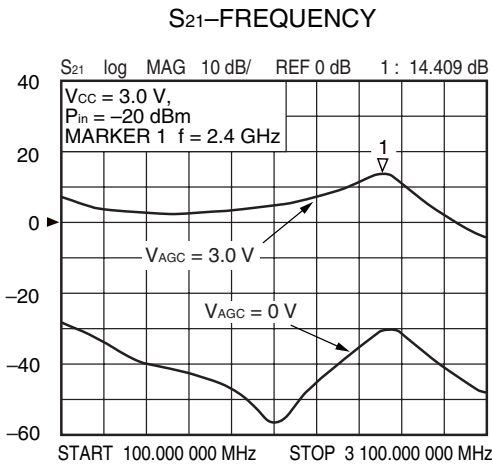
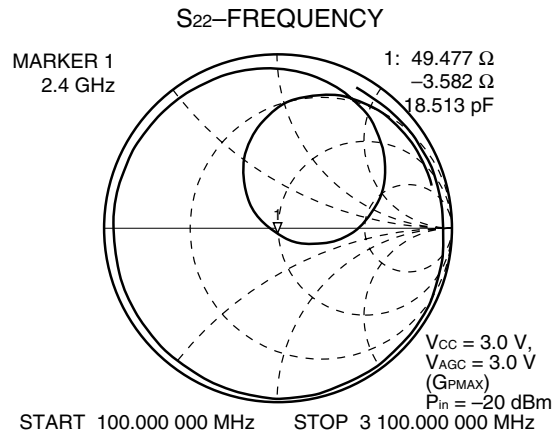
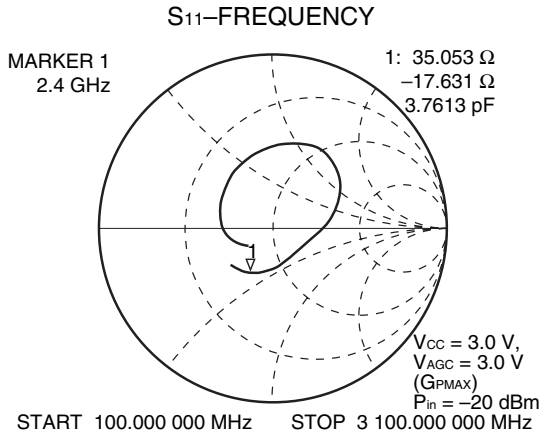

Remark The graphs indicate nominal characteristics.

S₂₁-FREQUENCY

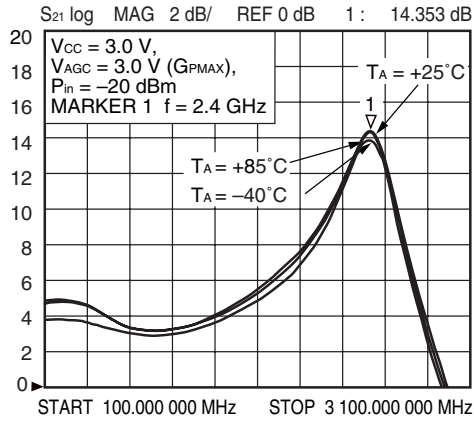

S₁₁-FREQUENCY

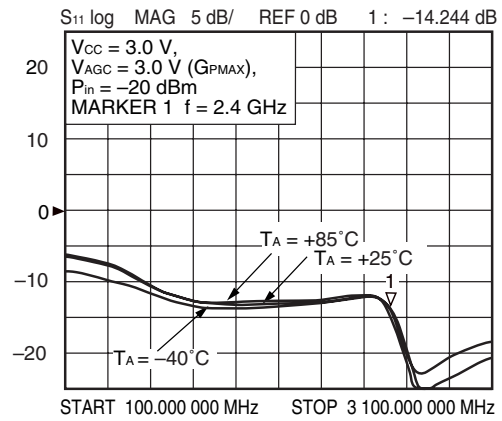

S₁₂-FREQUENCY

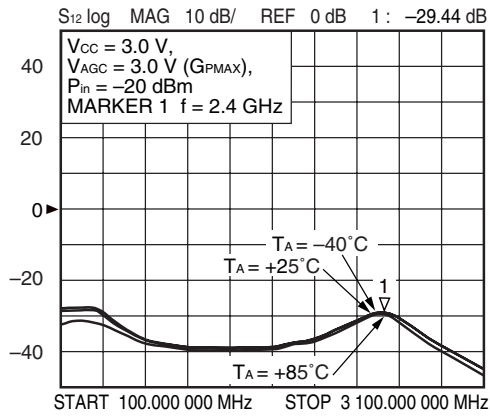

S₂₂-FREQUENCY

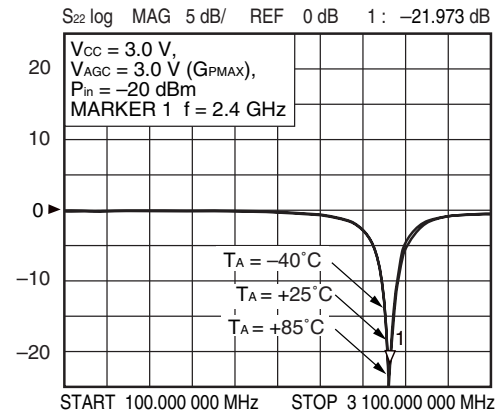

Remark The graphs indicate nominal characteristics.

S₂₁-FREQUENCY

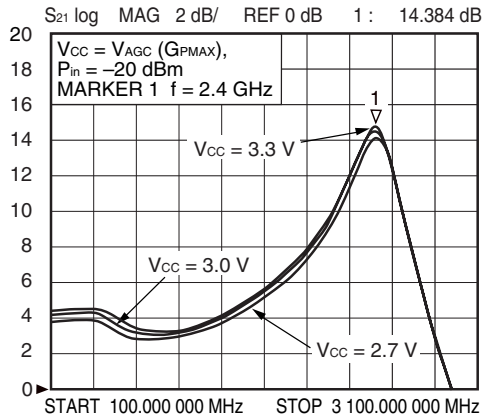

S₁₁-FREQUENCY

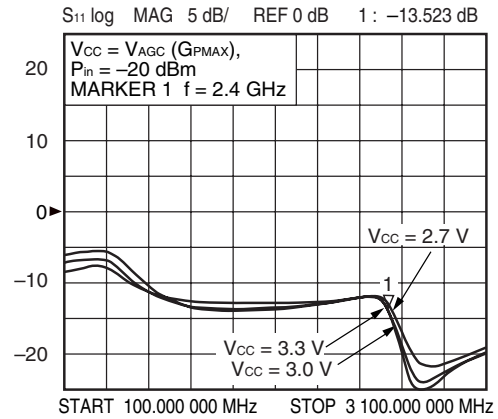

S₁₂-FREQUENCY

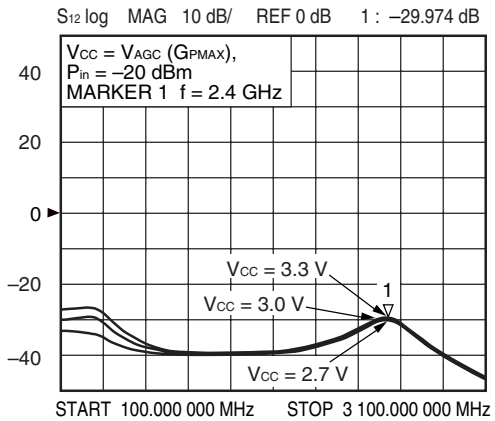

S₂₂-FREQUENCY

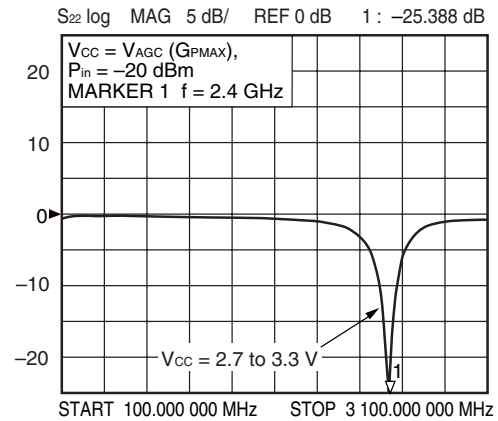

Remark The graphs indicate nominal characteristics.

S₂₁-FREQUENCY

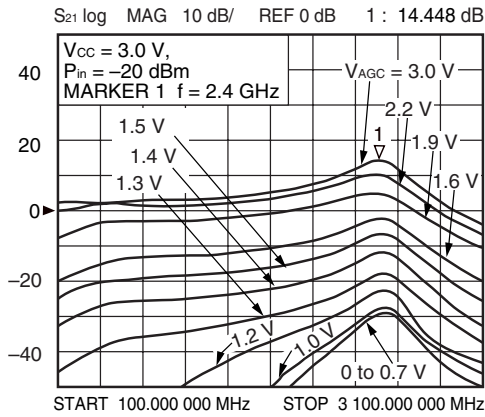

S₁₁-FREQUENCY

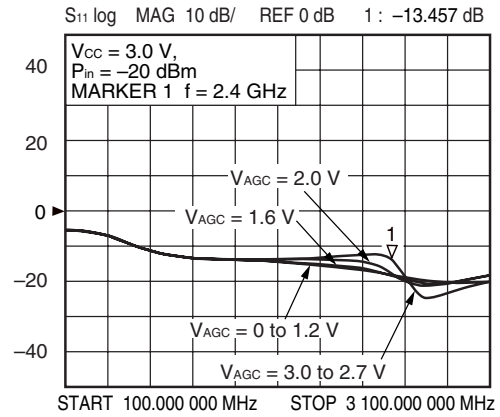

S₁₂-FREQUENCY

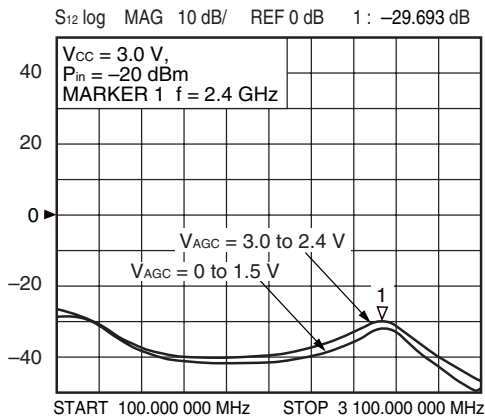

S₂₂-FREQUENCY

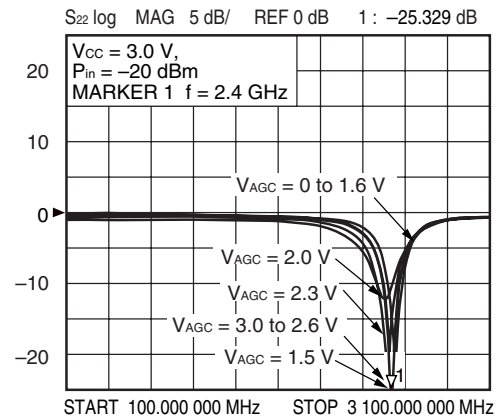

Remark The graphs indicate nominal characteristics.

POWER GAIN vs. GAIN CONTROL VOLTAGE

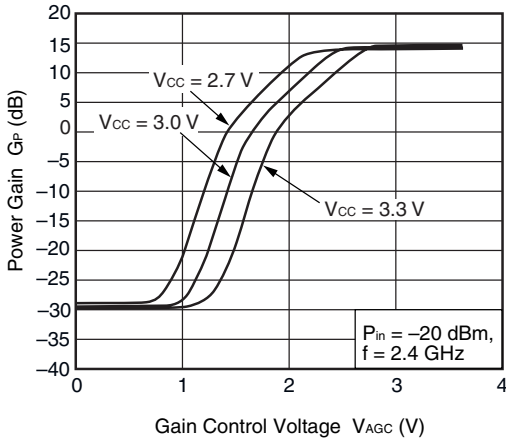

POWER GAIN vs. GAIN CONTROL VOLTAGE

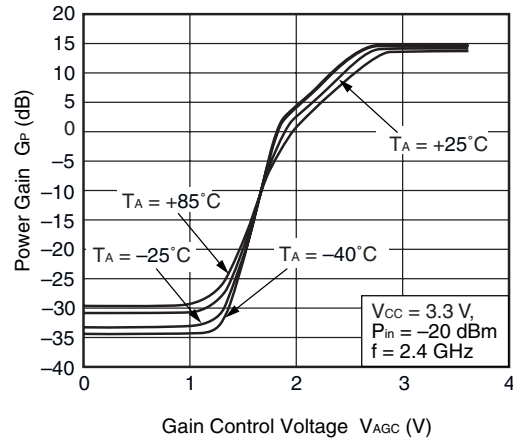

POWER GAIN vs. GAIN CONTROL VOLTAGE

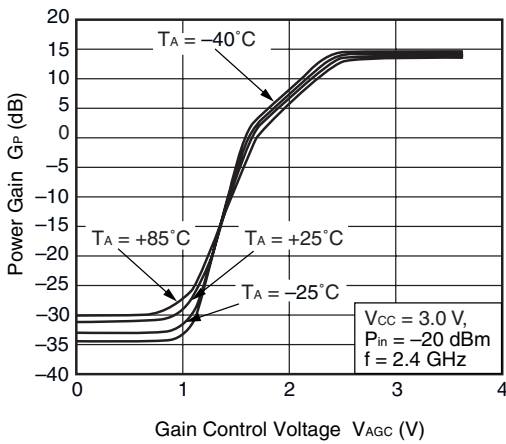

POWER GAIN vs. GAIN CONTROL VOLTAGE

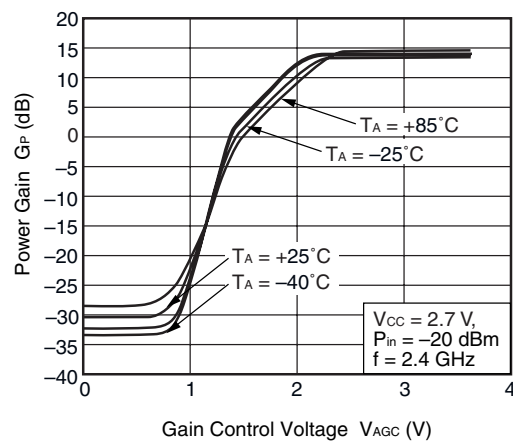

OUTPUT POWER vs. INPUT POWER

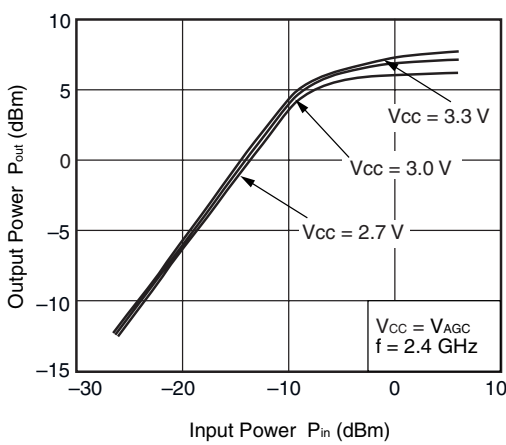

OUTPUT POWER vs. INPUT POWER

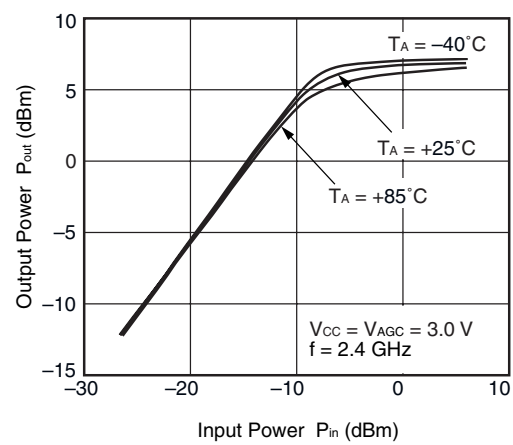

Remark The graphs indicate nominal characteristics.

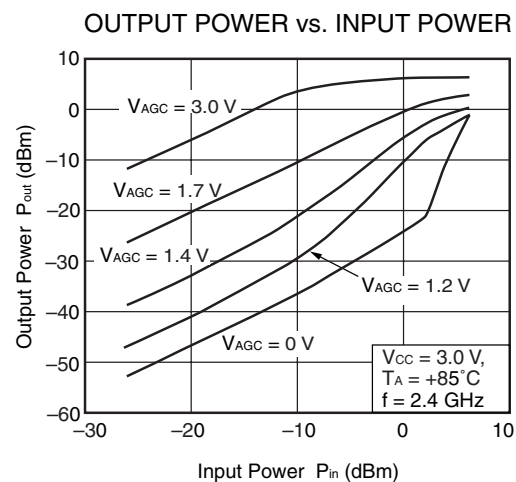
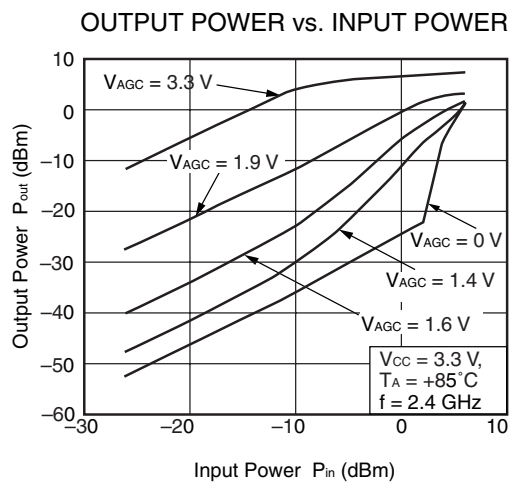
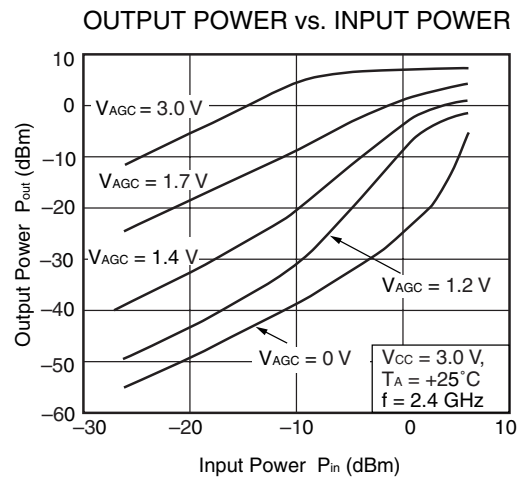
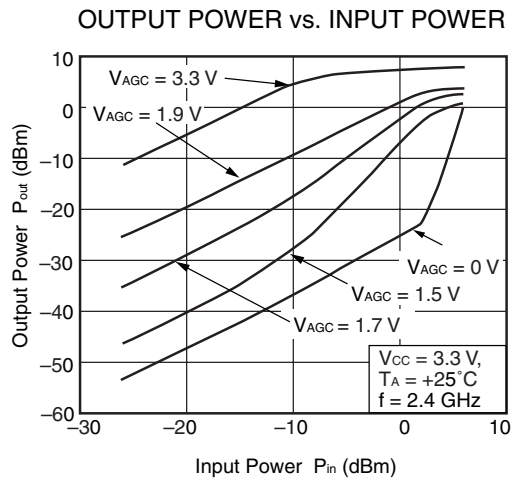
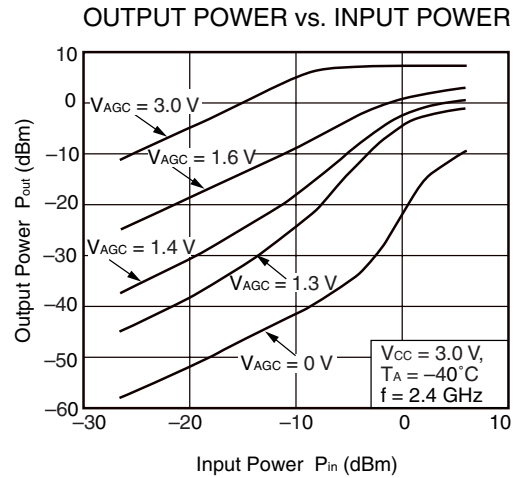
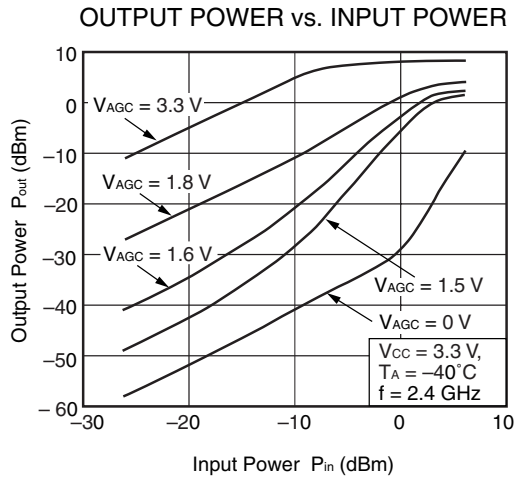

Remark The graphs indicate nominal characteristics.

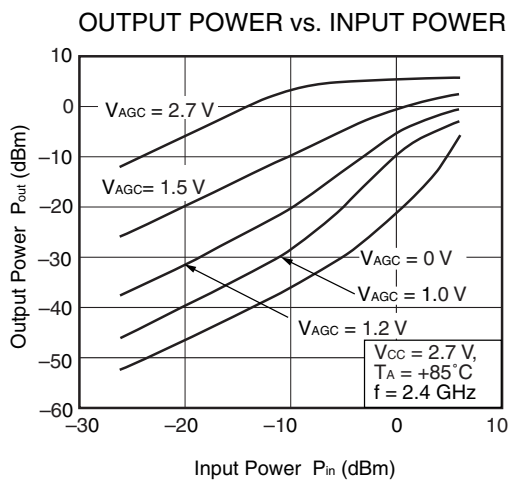
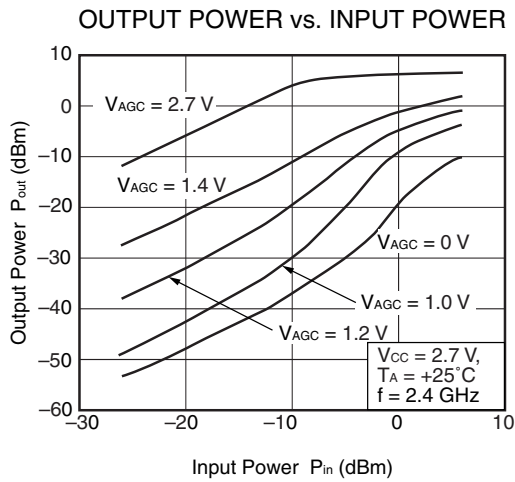
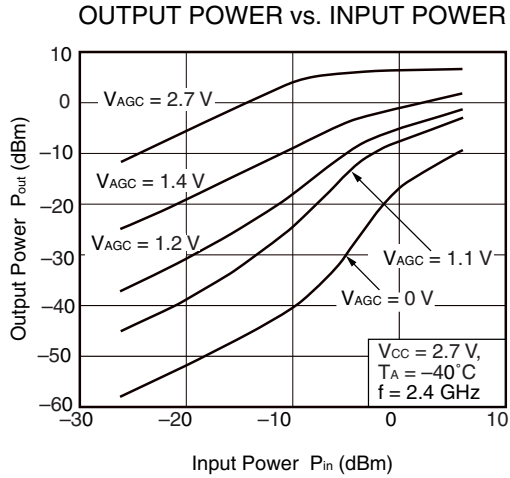

Remark The graphs indicate nominal characteristics.

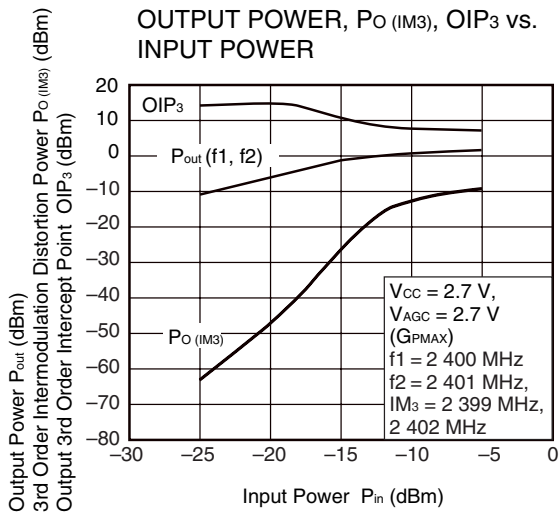
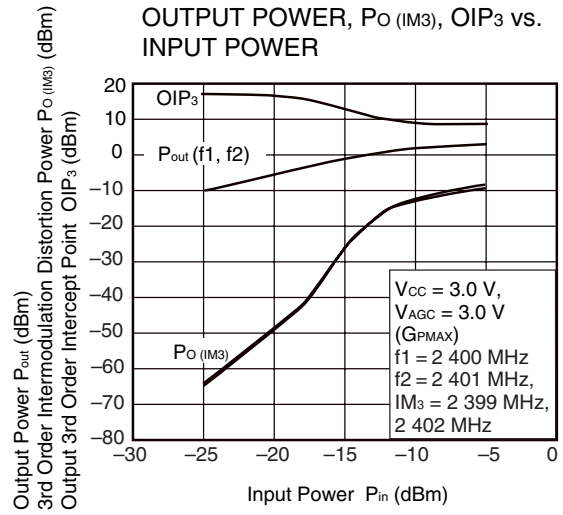
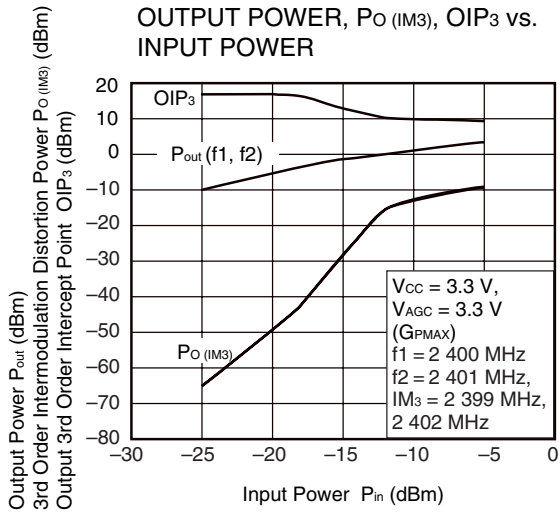

Remark The graphs indicate nominal characteristics.

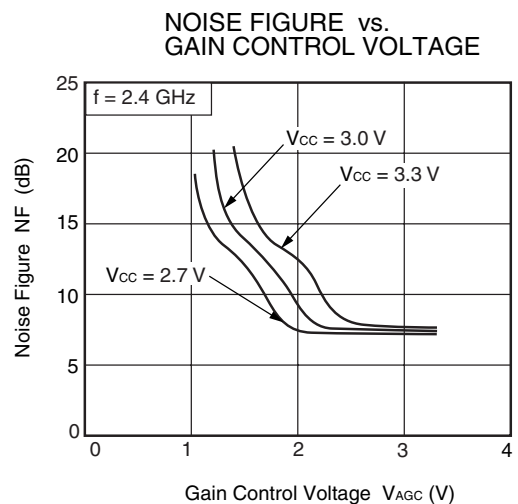
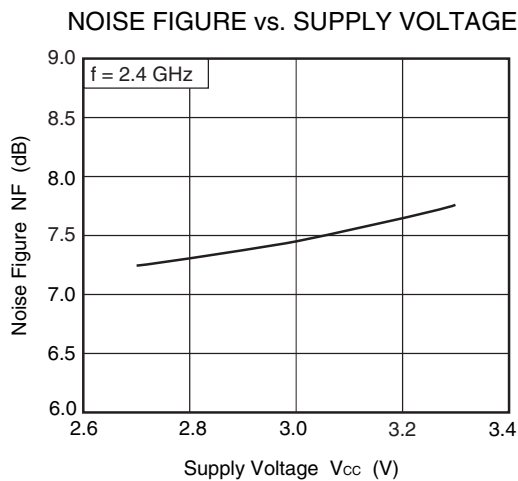
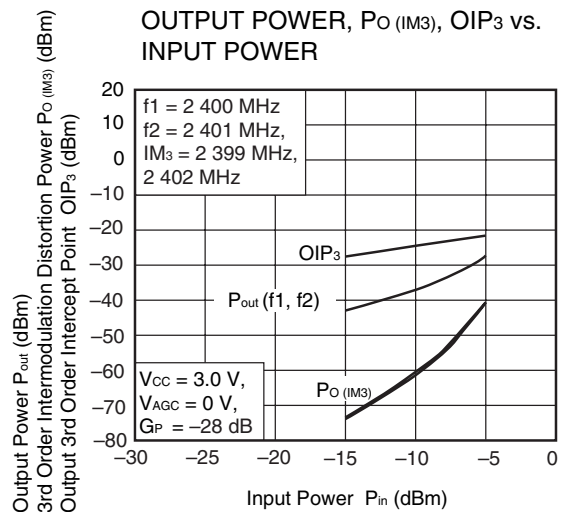
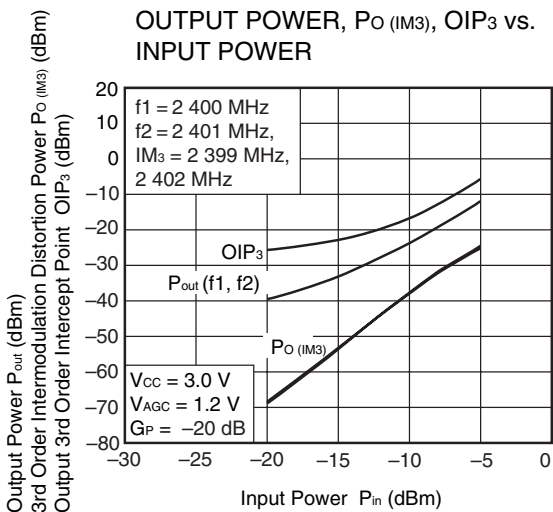
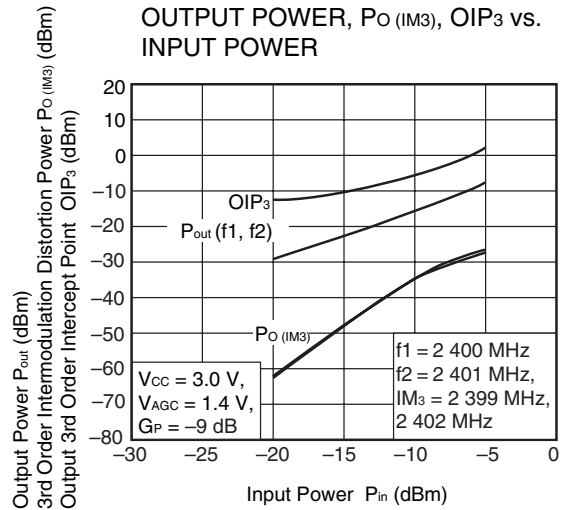
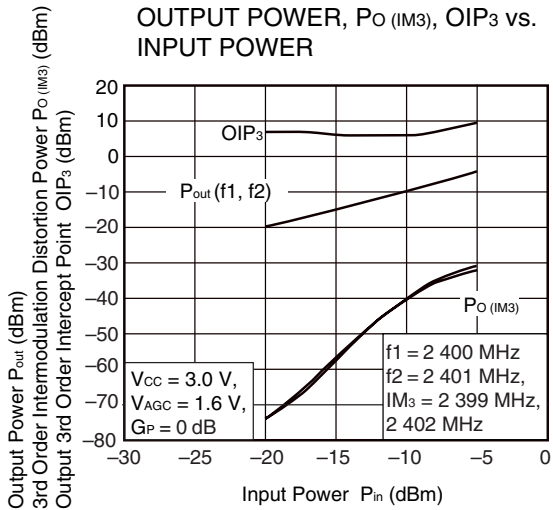

Remark The graphs indicate nominal characteristics.

★ 7. PACKAGE DIMENSIONS

6-PIN LEAD-LESS MINIMOLD (1511 PKG) (UNIT: mm)

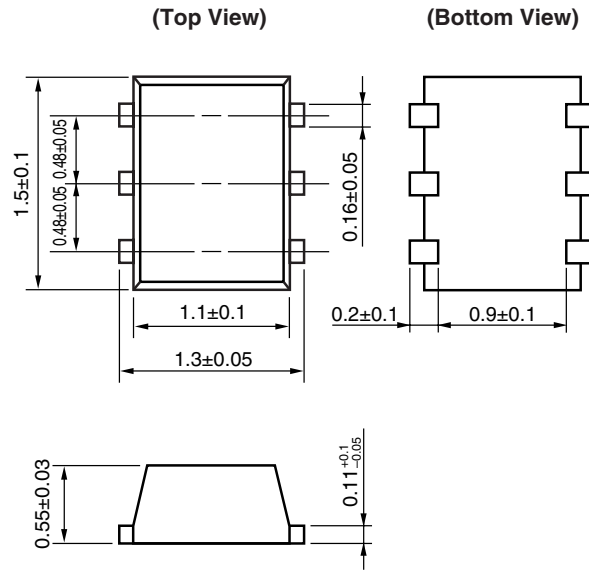

8. NOTES ON CORRECT USE

- (1) Observe precautions for handling because of electro-static sensitive devices.
- (2) Form a ground pattern as wide as possible to minimize ground impedance (to prevent undesired oscillation).
All the ground pins must be connected together with wide ground pattern to decrease impedance difference.
- (3) The bypass capacitor should be attached to the V_{CC} terminal.
- (4) Impedance matching circuit must be each externally attached to input and output ports.
- (5) The DC capacitor must be attached to input terminal.

★ **9. RECOMMENDED SOLDERING CONDITIONS**

This product should be soldered and mounted under the following recommended conditions. For soldering methods and conditions other than those recommended below, contact your nearby sales office.

Soldering Method	Soldering Conditions	Condition Symbol
Infrared Reflow	Peak temperature (package surface temperature) : 260°C or below Time at peak temperature : 10 seconds or less Time at temperature of 220°C or higher : 60 seconds or less Preheating time at 120 to 180°C : 120±30 seconds Maximum number of reflow processes : 3 times Maximum chlorine content of rosin flux (% mass) : 0.2%(Wt.) or below	IR260
Wave Soldering	Peak temperature (molten solder temperature) : 260°C or below Time at peak temperature : 10 seconds or less Preheating temperature (package surface temperature) : 120°C or below Maximum number of flow processes : 1 time Maximum chlorine content of rosin flux (% mass) : 0.2%(Wt.) or below	WS260
Partial Heating	Peak temperature (terminal temperature) : 350°C or below Soldering time (per side of device) : 3 seconds or less Maximum chlorine content of rosin flux (% mass) : 0.2%(Wt.) or below	HS350

Caution Do not use different soldering methods together (except for partial heating).

When the product(s) listed in this document is subject to any applicable import or export control laws and regulation of the authority having competent jurisdiction, such product(s) shall not be imported or exported without obtaining the import or export license.

- **The information in this document is current as of October, 2005. The information is subject to change without notice. For actual design-in, refer to the latest publications of NEC's data sheets or data books, etc., for the most up-to-date specifications of NEC semiconductor products. Not all products and/or types are available in every country. Please check with an NEC sales representative for availability and additional information.**
 - No part of this document may be copied or reproduced in any form or by any means without prior written consent of NEC. NEC assumes no responsibility for any errors that may appear in this document.
 - NEC does not assume any liability for infringement of patents, copyrights or other intellectual property rights of third parties by or arising from the use of NEC semiconductor products listed in this document or any other liability arising from the use of such products. No license, express, implied or otherwise, is granted under any patents, copyrights or other intellectual property rights of NEC or others.
 - Descriptions of circuits, software and other related information in this document are provided for illustrative purposes in semiconductor product operation and application examples. The incorporation of these circuits, software and information in the design of customer's equipment shall be done under the full responsibility of customer. NEC assumes no responsibility for any losses incurred by customers or third parties arising from the use of these circuits, software and information.
 - While NEC endeavours to enhance the quality, reliability and safety of NEC semiconductor products, customers agree and acknowledge that the possibility of defects thereof cannot be eliminated entirely. To minimize risks of damage to property or injury (including death) to persons arising from defects in NEC semiconductor products, customers must incorporate sufficient safety measures in their design, such as redundancy, fire-containment, and anti-failure features.
 - NEC semiconductor products are classified into the following three quality grades:
 "Standard", "Special" and "Specific". The "Specific" quality grade applies only to semiconductor products developed based on a customer-designated "quality assurance program" for a specific application. The recommended applications of a semiconductor product depend on its quality grade, as indicated below. Customers must check the quality grade of each semiconductor product before using it in a particular application.
 "Standard": Computers, office equipment, communications equipment, test and measurement equipment, audio and visual equipment, home electronic appliances, machine tools, personal electronic equipment and industrial robots
 "Special": Transportation equipment (automobiles, trains, ships, etc.), traffic control systems, anti-disaster systems, anti-crime systems, safety equipment and medical equipment (not specifically designed for life support)
 "Specific": Aircraft, aerospace equipment, submersible repeaters, nuclear reactor control systems, life support systems and medical equipment for life support, etc.
- The quality grade of NEC semiconductor products is "Standard" unless otherwise expressly specified in NEC's data sheets or data books, etc. If customers wish to use NEC semiconductor products in applications not intended by NEC, they must contact an NEC sales representative in advance to determine NEC's willingness to support a given application.
- (Note)
- (1) "NEC" as used in this statement means NEC Corporation, NEC Compound Semiconductor Devices, Ltd. and also includes its majority-owned subsidiaries.
 - (2) "NEC semiconductor products" means any semiconductor product developed or manufactured by or for NEC (as defined above).

M8E 00.4-0110

► For further information, please contact

NEC Compound Semiconductor Devices, Ltd. <http://www.ncsd.necel.com/>

E-mail: salesinfo@ml.ncsd.necel.com (sales and general)

techinfo@ml.ncsd.necel.com (technical)

Sales Division TEL: +81-44-435-1573 FAX: +81-44-435-1579

NEC Compound Semiconductor Devices Hong Kong Limited

E-mail: ncsd-hk@elhk.nec.com.hk (sales, technical and general)

Hong Kong Head Office TEL: +852-3107-7303 FAX: +852-3107-7309

Taipei Branch Office TEL: +886-2-8712-0478 FAX: +886-2-2545-3859

Korea Branch Office TEL: +82-2-558-2120 FAX: +82-2-558-5209

NEC Electronics (Europe) GmbH <http://www.ee.nec.de/>

TEL: +49-211-6503-0 FAX: +49-211-6503-1327

California Eastern Laboratories, Inc. <http://www.cel.com/>

TEL: +1-408-988-3500 FAX: +1-408-988-0279

0504