

GENERAL PURPOSE DUAL OPERATIONAL AMPLIFIER

DESCRIPTION

The μPC1458 is a dual general purpose operational amplifier having internal frequency compensating circuits. It is intended for a wide range of analog applications. High common mode voltage range and no latch up tendencies make this amplifier ideal for use as a voltage follower.

FEATURES

- Internally frequency-compensated
- Short circuit protection

EQUIVALENT CIRCUIT (1/2 Circuit)

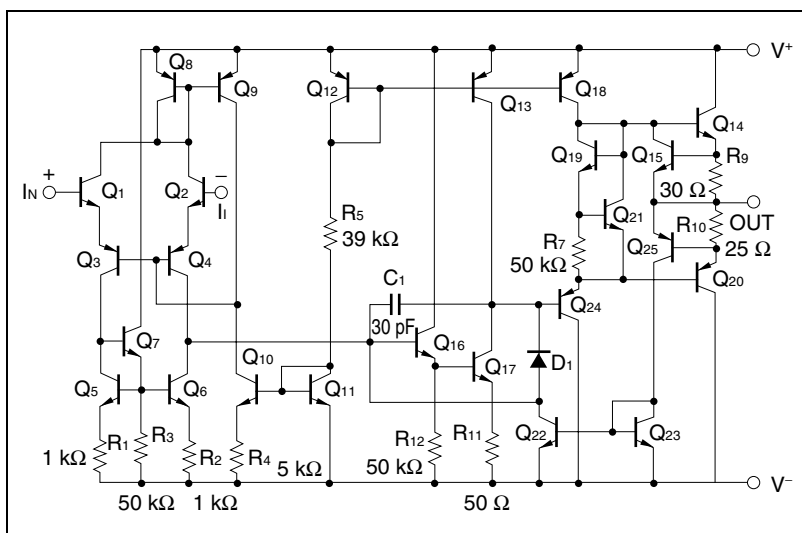

CONNECTION DIAGRAM (Top View)

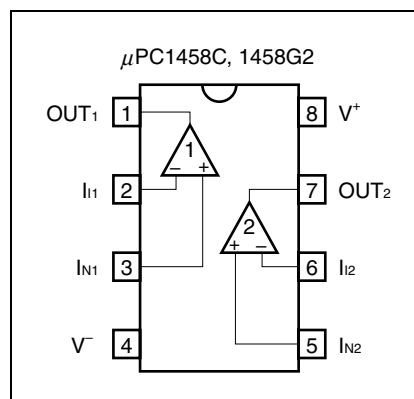

★ ORDERING INFORMATION

PART NUMBER	PACKAGE	QUALITY GRADE
μPC1458C	8-pin plastic DIP (7.62 mm (300))	Standard
μPC1458G2	8-pin plastic SOP (5.72 mm (225))	Standard

Please refer to "Quality Grades on NEC Semiconductor Devices" (Document No: C11531E) published by NEC Electronics Corporation to know the specification of the quality grade on the device and its recommended applications.

The information in this document is subject to change without notice. Before using this document, please confirm that this is the latest version.
 Not all products and/or types are available in every country. Please check with an NEC Electronics sales representative for availability and additional information.

ABSOLUTE MAXIMUM RATINGS (T_a = 25 °C)

PARAMETER		SYMBOL	μPC1458	UNIT
Voltage between V ⁺ and V ⁻ (Note 1)		V ⁺ - V ⁻	-0.3 to +36	V
Differential Input Voltage		V _{ID}	±30	V
Input Voltage (Note 2)		V _I	V ⁻ -0.3 to V ⁺ +0.3	V
Output Voltage (Note 3)		V _O	V ⁻ -0.3 to V ⁺ +0.3	V
Power Dissipation	C Package (Note 4)	P _T	350	mW
	G2 Package (Note 5)		440	mW
Output Short Circuit Duration (Note 6)			Indefinite	sec
Operating Temperature Range		T _{opt}	-20 to +80	°C
Storage Temperature Range		T _{stg}	-55 to +125	°C

Note 1. Reverse connection of supply voltage can cause destruction.

Note 2. The input voltage should be allowed to input without damage or destruction. Even during the transition period of supply voltage, power on/off etc., this specification should be kept. The normal operation will establish when the both inputs are within the Common Mode Input Voltage Range of electrical characteristics.

Note 3. This specification is the voltage which should be allowed to supply to the output terminal from external without damage or destruction. Even during the transition period of supply voltage, power on/off etc., this specification should be kept. The output voltage of normal operation will be the Output Voltage Swing of electrical characteristics.

Note 4. Thermal derating factor is -5.0 mW/°C when ambient temperature is higher than 55 °C.

Note 5. Thermal derating factor is -4.4 mW/°C when ambient temperature is higher than 25 °C.

Note 6. Pay careful attention to the total power dissipation not to exceed the absolute maximum ratings, Notes 4 and 5.

RECOMMENDED OPERATING CONDITIONS

CHARACTERISTIC	SYMBOL	MIN.	TYP.	MAX.	UNIT
Supply Voltage (Split)	V [±]	±7.5		±16	V
Supply Voltage (V ⁻ = GND)	V ⁺	+15		+32	V
Output Current	I _o		±2	±5	mA

ELECTRICAL CHARACTERISTICS (V[±] = ±15V, T_a = 25 °C)

CHARACTERISTIC	SYMBOL	MIN.	TYP.	MAX.	UNIT	CONDITIONS
Input Offset Voltage	V _{io}		±1.0	±6.0	mV	R _s ≤ 10 kΩ
Average Input Offset Voltage Drift	ΔV _{io} /ΔT		±3		μV/°C	R _s ≤ 10 kΩ
Input Offset Current (Note 7)	I _{io}		±20	±200	nA	
Input Bias Current (Note 7)	I _b		80	500	nA	
Input Impedance	R _{in}	0.3	1.0		MΩ	
Large Signal Voltage Gain	A _v	20000	160000			R _L ≥ 2 kΩ, V _o = ±10 V
Supply Current	I _{cc}		3.0	5.6	mA	I _o = 0 A, Both Amplifiers
Power Consumption	P _d		90	170	mW	I _o = 0 A, Both Amplifiers
Common Mode Rejection Ratio	CMR	70	90		dB	R _s ≤ 10 kΩ
Supply Voltage Rejection Ratio	SVR		30	150	μV/V	R _s ≤ 10 kΩ
Output Voltage Swing	V _{om}	±12	+14 -12		V	R _L ≥ 10 kΩ
Output Voltage Swing	V _{om}	±10	+13 -11		V	R _L ≥ 2 kΩ
Common Mode Input Voltage Range	V _{icm}		V ⁺ -0.5 V ⁻ +2		V	
Channel Separation			120		dB	f = 10 Hz, R _L = 2 kΩ

Note 7. Input bias currents flow into IC. Because each currents are base current of NPN-transistor on input stage.

TYPICAL PERFORMANCE CHARACTERISTICS (T_a = 25 °C, TYP.)

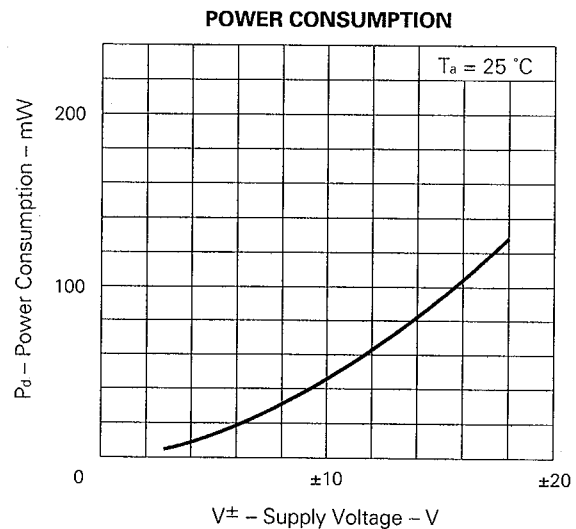
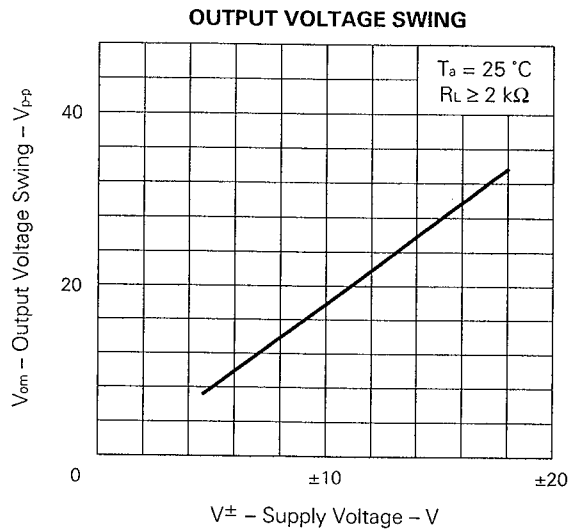
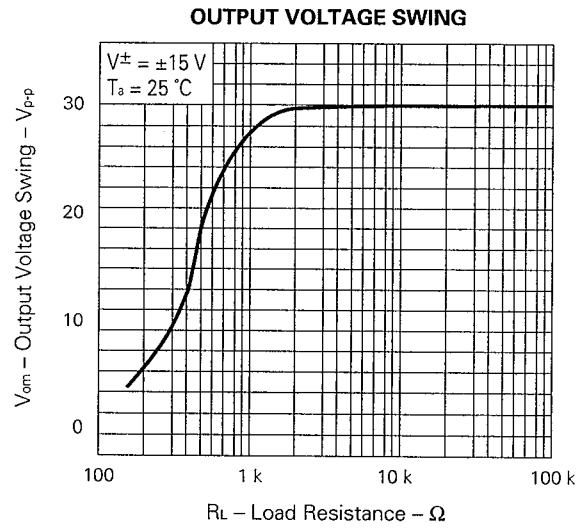
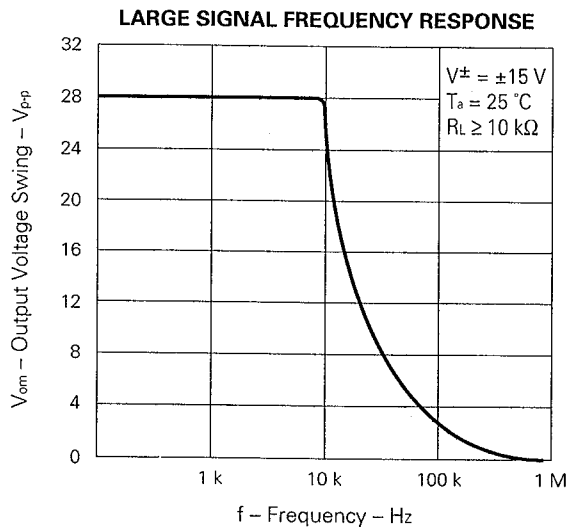
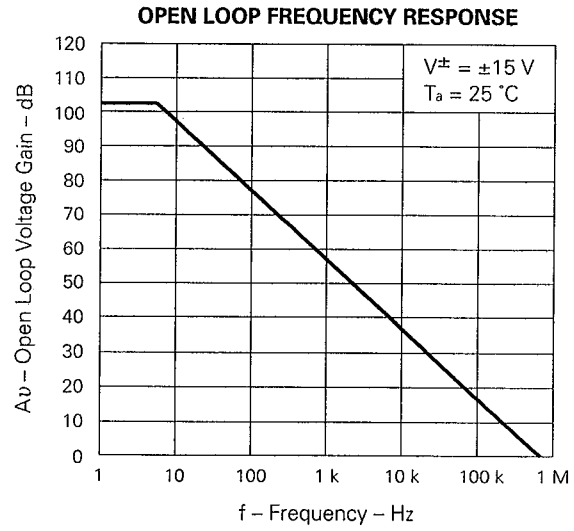
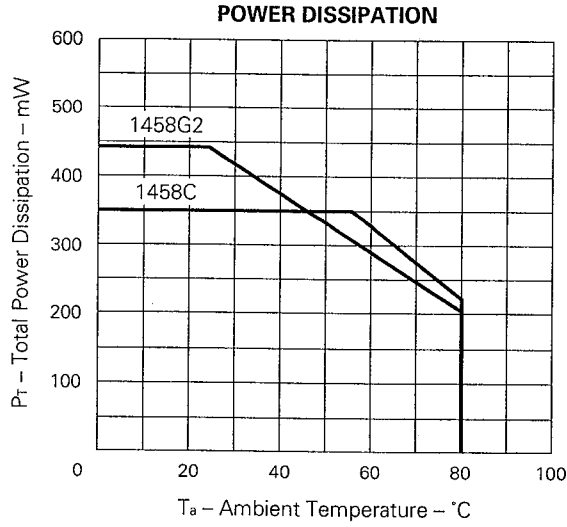

SUPPLY CURRENT

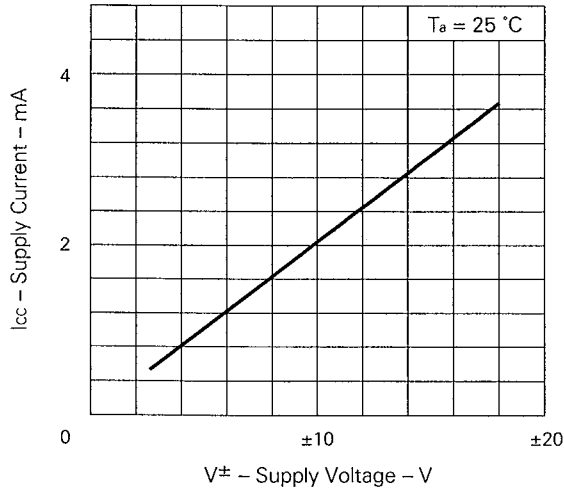

SUPPLY CURRENT

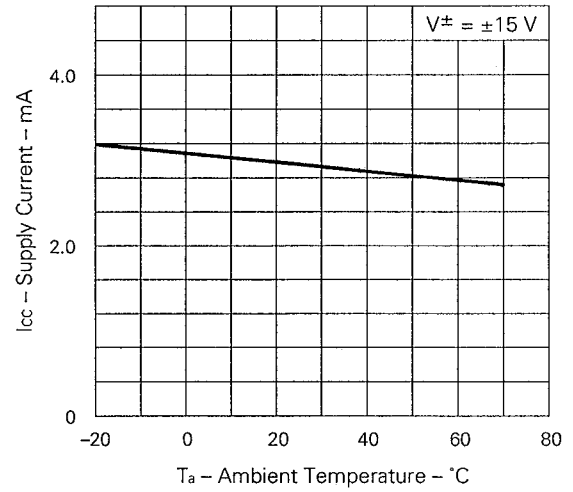

OUTPUT SHORT CIRCUIT CURRENT

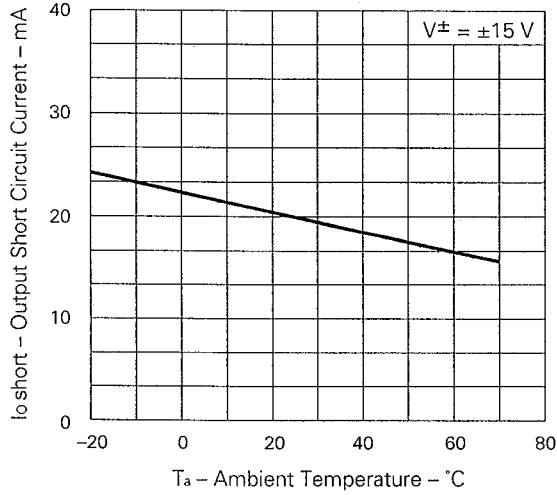

POWER CONSUMPTION

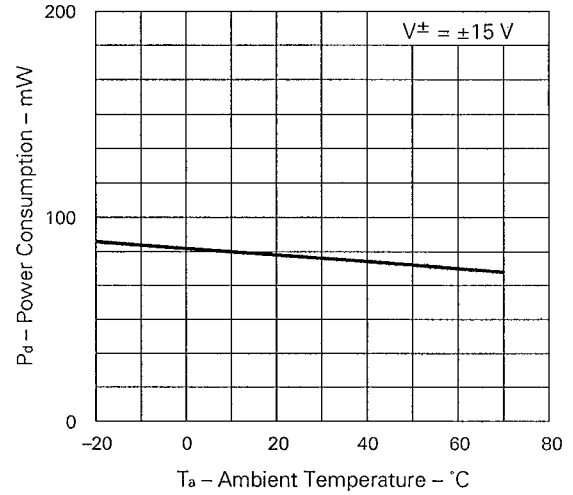

INPUT BIAS CURRENT

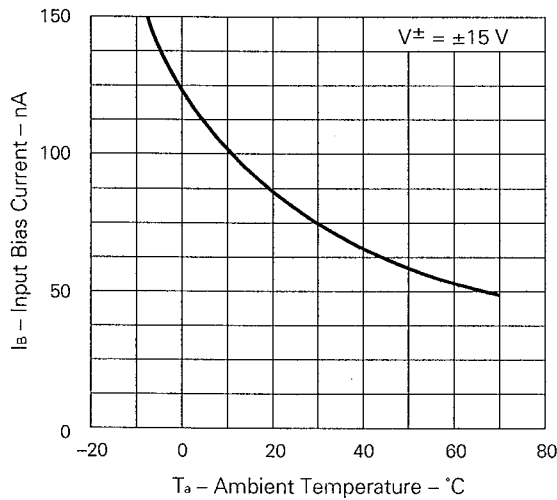

INPUT OFFSET CURRENT

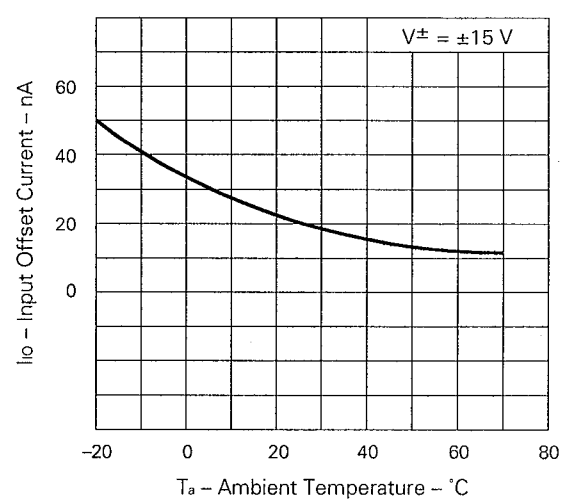

★ PACKAGE DRAWINGS (Unit: mm)

8-PIN PLASTIC DIP (7.62mm(300))

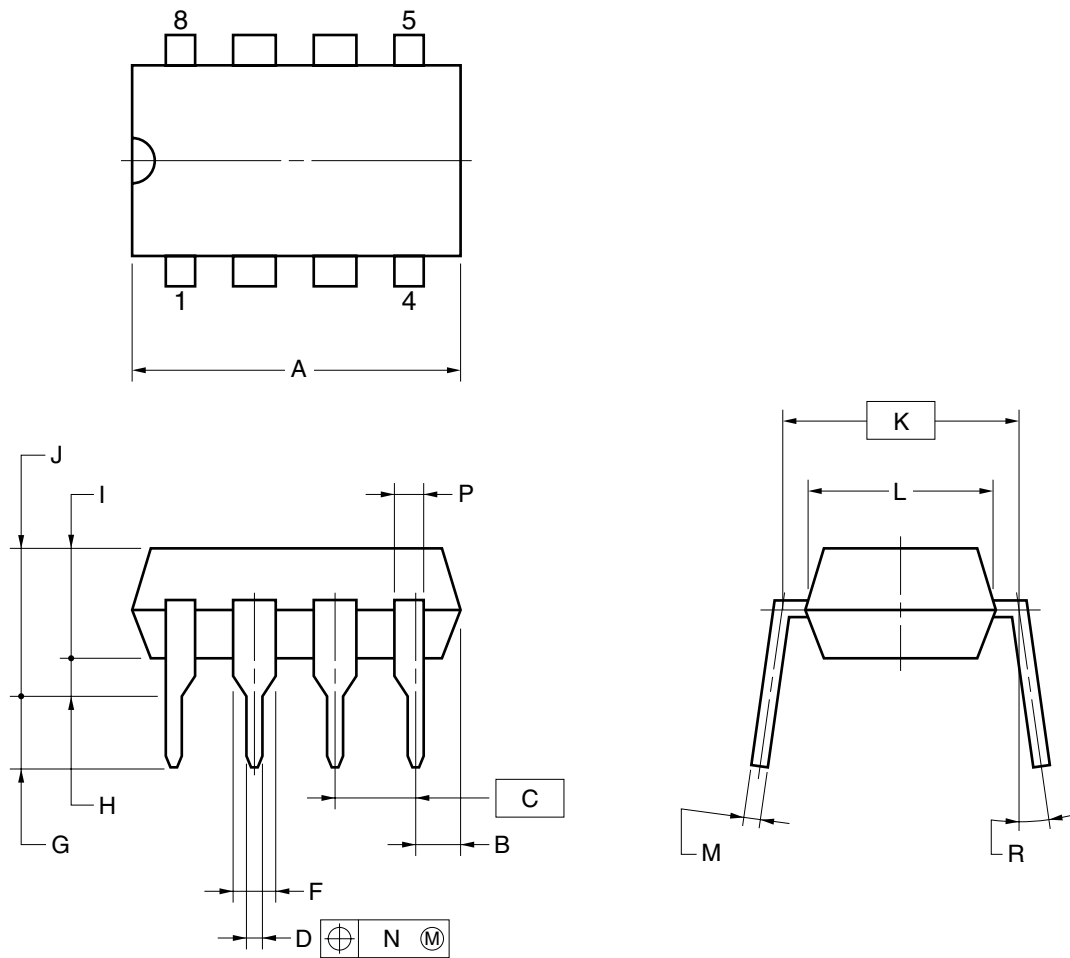

NOTES

1. Each lead centerline is located within 0.25 mm of its true position (T.P.) at maximum material condition.
2. Item "K" to center of leads when formed parallel.

ITEM	MILLIMETERS
A	10.16 MAX.
B	1.27 MAX.
C	2.54 (T.P.)
D	0.50±0.10
F	1.4 MIN.
G	3.2±0.3
H	0.51 MIN.
I	4.31 MAX.
J	5.08 MAX.
K	7.62 (T.P.)
L	6.4
M	0.25 ^{+0.10} _{-0.05}
N	0.25
P	0.9 MIN.
R	0-15°

P8C-100-300B,C-2

8-PIN PLASTIC SOP (5.72 mm (225))

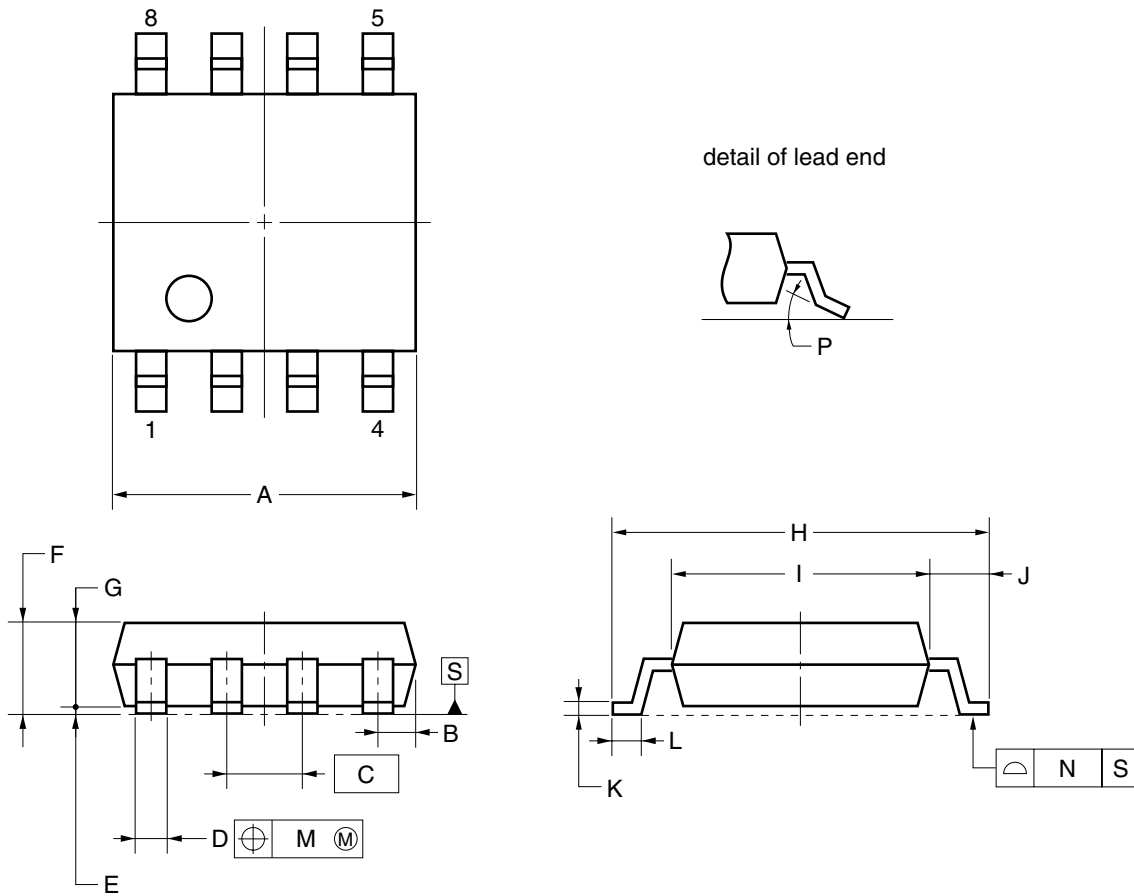

NOTE

Each lead centerline is located within 0.12 mm of its true position (T.P.) at maximum material condition.

ITEM	MILLIMETERS
A	5.2 ^{+0.17} / _{-0.20}
B	0.78 MAX.
C	1.27 (T.P.)
D	0.42 ^{+0.08} / _{-0.07}
E	0.1±0.1
F	1.59±0.21
G	1.49
H	6.5±0.3
I	4.4±0.15
J	1.1±0.2
K	0.17 ^{+0.08} / _{-0.07}
L	0.6±0.2
M	0.12
N	0.10
P	3° ^{+7°} / _{-3°}

S8GM-50-225B-6

★ RECOMMENDED SOLDERING CONDITIONS

The μPC1458 should be soldered and mounted under the following recommended conditions.

For soldering methods and conditions other than those recommended below, contact an NEC Electronics sales representative.

For technical information, see the following website.

Semiconductor Device Mount Manual (<http://www.necel.com/pkg/en/mount/index.html>)

TYPES OF SURFACE MOUNT DEVICE

μPC1458G2: 8-pin plastic SOP (5.72 mm (225))

Process	Conditions	Symbol
Infrared Ray Reflow	Peak temperature: 230°C or below (Package surface temperature), Reflow time: 30 seconds or less (at 210°C or higher), Maximum number of reflow processes: 1 time.	IR30-00-1
Vapor Phase Soldering	Peak temperature: 215°C or below (Package surface temperature), Reflow time: 40 seconds or less (at 200°C or higher), Maximum number of reflow processes: 1 time.	VP15-00-1
Wave Soldering	Solder temperature: 260°C or below, Flow time: 10 seconds or less, Maximum number of flow processes: 1 time, Pre-heating temperature: 120°C or below (Package surface temperature).	WS60-00-1
Partial Heating Method	Pin temperature: 300°C or below, Heat time: 3 seconds or less (Per each side of the device).	—

Caution Apply only one kind of soldering condition to a device, except for "partial heating method", or the device will be damaged by heat stress.

TYPES OF THROUGH HOLE DEVICE

μPC1458C: 8-pin plastic DIP (7.62 mm (300))

Soldering method	Soldering conditions	Recommended condition symbol
Wave soldering	Solder temperature: 260°C or below, Flow time: 10 seconds or below	

• **The information in this document is current as of March, 2004. The information is subject to change without notice. For actual design-in, refer to the latest publications of NEC Electronics data sheets or data books, etc., for the most up-to-date specifications of NEC Electronics products. Not all products and/or types are available in every country. Please check with an NEC Electronics sales representative for availability and additional information.**

• No part of this document may be copied or reproduced in any form or by any means without the prior written consent of NEC Electronics. NEC Electronics assumes no responsibility for any errors that may appear in this document.

• NEC Electronics does not assume any liability for infringement of patents, copyrights or other intellectual property rights of third parties by or arising from the use of NEC Electronics products listed in this document or any other liability arising from the use of such products. No license, express, implied or otherwise, is granted under any patents, copyrights or other intellectual property rights of NEC Electronics or others.

• Descriptions of circuits, software and other related information in this document are provided for illustrative purposes in semiconductor product operation and application examples. The incorporation of these circuits, software and information in the design of a customer's equipment shall be done under the full responsibility of the customer. NEC Electronics assumes no responsibility for any losses incurred by customers or third parties arising from the use of these circuits, software and information.

• While NEC Electronics endeavors to enhance the quality, reliability and safety of NEC Electronics products, customers agree and acknowledge that the possibility of defects thereof cannot be eliminated entirely. To minimize risks of damage to property or injury (including death) to persons arising from defects in NEC Electronics products, customers must incorporate sufficient safety measures in their design, such as redundancy, fire-containment and anti-failure features.

• NEC Electronics products are classified into the following three quality grades: "Standard", "Special" and "Specific".

The "Specific" quality grade applies only to NEC Electronics products developed based on a customer-designated "quality assurance program" for a specific application. The recommended applications of an NEC Electronics product depend on its quality grade, as indicated below. Customers must check the quality grade of each NEC Electronics product before using it in a particular application.

"Standard": Computers, office equipment, communications equipment, test and measurement equipment, audio and visual equipment, home electronic appliances, machine tools, personal electronic equipment and industrial robots.

"Special": Transportation equipment (automobiles, trains, ships, etc.), traffic control systems, anti-disaster systems, anti-crime systems, safety equipment and medical equipment (not specifically designed for life support).

"Specific": Aircraft, aerospace equipment, submersible repeaters, nuclear reactor control systems, life support systems and medical equipment for life support, etc.

The quality grade of NEC Electronics products is "Standard" unless otherwise expressly specified in NEC Electronics data sheets or data books, etc. If customers wish to use NEC Electronics products in applications not intended by NEC Electronics, they must contact an NEC Electronics sales representative in advance to determine NEC Electronics' willingness to support a given application.

(Note)

(1) "NEC Electronics" as used in this statement means NEC Electronics Corporation and also includes its majority-owned subsidiaries.

(2) "NEC Electronics products" means any product developed or manufactured by or for NEC Electronics (as defined above).