

FEATURES

- **FREQUENCY RESPONSE:** 1.5 GHz
- **INTERNAL CURRENT REGULATION MINIMIZES GAIN CHANGE OVER TEMPERATURE**
- **5 V SINGLE SUPPLY VOLTAGE**
- **SUPER SMALL PACKAGE**
- **TAPE AND REEL PACKAGING OPTION AVAILABLE**

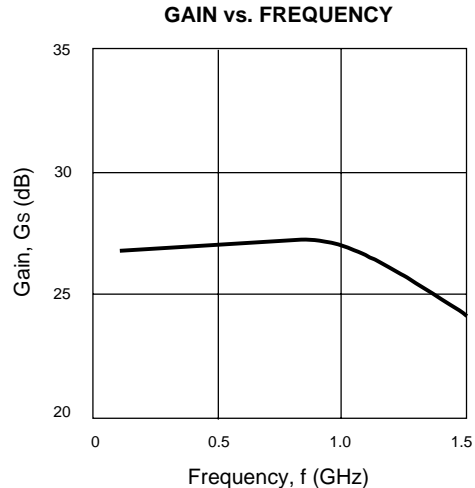

DESCRIPTION

The UPC2713T is a Silicon Monolithic integrated circuit manufactured using the NESAT III process. This device is suitable for applications which require high gain and wide-band operation. It is designed for low cost gain stages in cellular radios, GPS receivers, DBS tuners, PCN, and test/measurement equipment.

NEC's stringent quality assurance and test procedures ensure the highest reliability and performance.

ELECTRICAL CHARACTERISTICS (T_A = 25 °C, f = 0.5 GHz, V_{CC} = 5 V)

PART NUMBER PACKAGE OUTLINE			UPC2713T T06		
SYMBOLS	PARAMETERS AND CONDITIONS	UNITS	MIN	TYP	MAX
I _{CC}	Circuit Current (no signal)	mA	9	12	15
G _s	Small Signal Gain	dB	26	29	33
f _u	Upper Limit Operating Frequency (The gain at f _u is 3 dB down from the gain at 0.1 GHz)	GHz	0.9	1.2	
ΔG _s	Gain Flatness, f = 0.1–0.8 GHz			±0.8	
P _{SAT}	Saturated Output Power	dBm	4	7	
P _{1dB}	Output Power at 1dB Compression Point	dBm		-4	
NF	Noise Figure	dB		3.2	4.5
RL _{IN}	Input Return Loss	dB	10	13	
RL _{OUT}	Output Return Loss	dB	6	9	
ISOL	Isolation	dB	35	40	
ΔG _T	Gain -Temperature Coefficient	dB/°C		-0.016	
R _{TH}	Thermal Resistance (Junction to Ambient)	°C/W			200

ABSOLUTE MAXIMUM RATINGS¹ (T_A = 25°C)

SYMBOLS	PARAMETERS	UNITS	RATINGS
V _{CC}	Supply Voltage	V	6
P _{IN}	Input Power	dBm	+10
P _T	Power Dissipation	mW	280 ²
T _{OP}	Operating Temperature	°C	-40 to +85
T _{STG}	Storage Temperature	°C	-55 to +150

Notes:

1. Operation in excess of any one of these parameters may result in permanent damage.
2. Mounted on 50 x 50 x 1.6 mm epoxy glass PWB (T_A = +85°C).

RECOMMENDED OPERATING CONDITIONS

SYMBOL	PARAMETER	UNITS	MIN	TYP	MAX
V _{CC}	Supply Voltage	V	4.5	5.0	5.5

TEST CIRCUIT

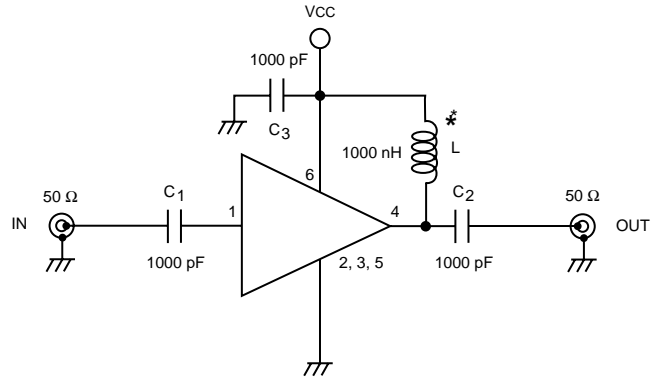

TYPICAL PERFORMANCE CURVES (T_A = 25°C)

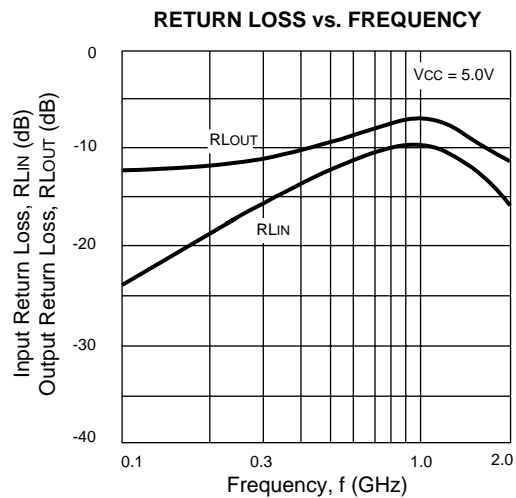
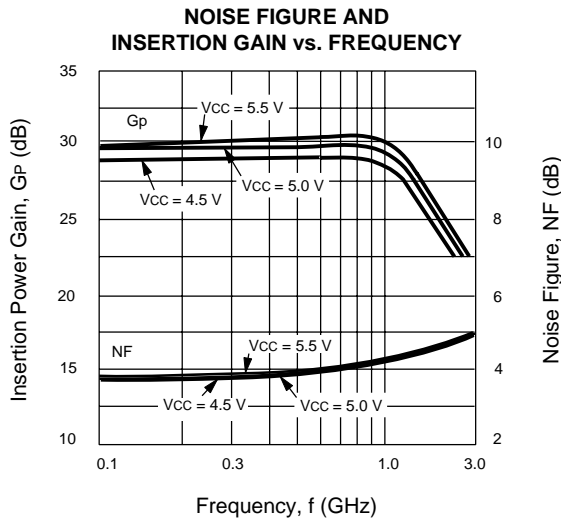
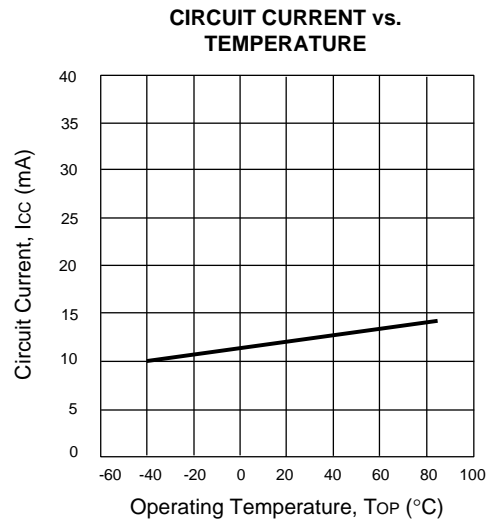
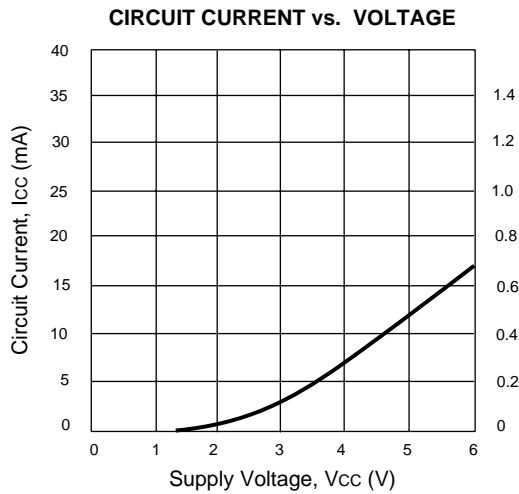

TYPICAL PERFORMANCE CURVES ($T_A = 25^\circ\text{C}$)

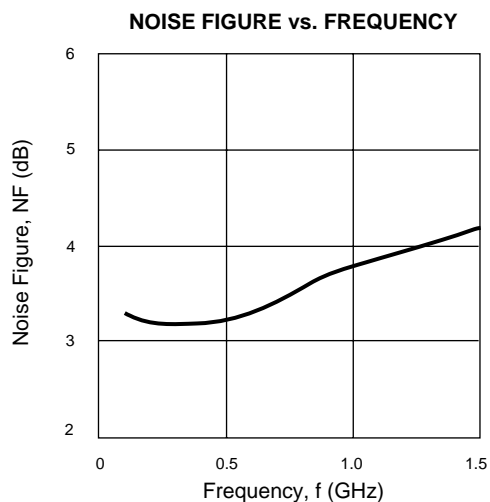
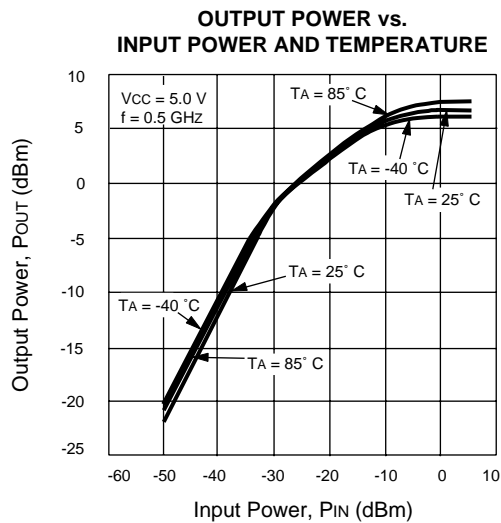
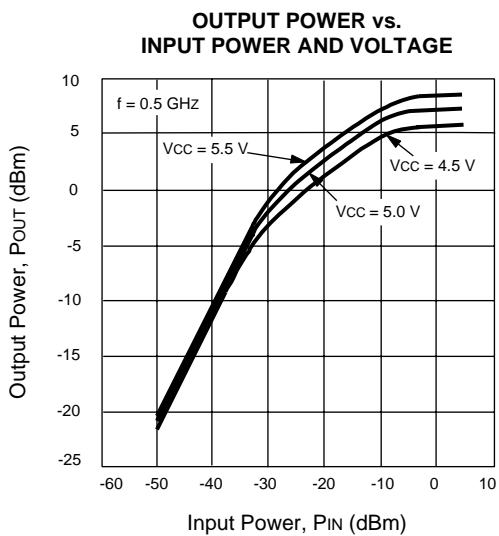
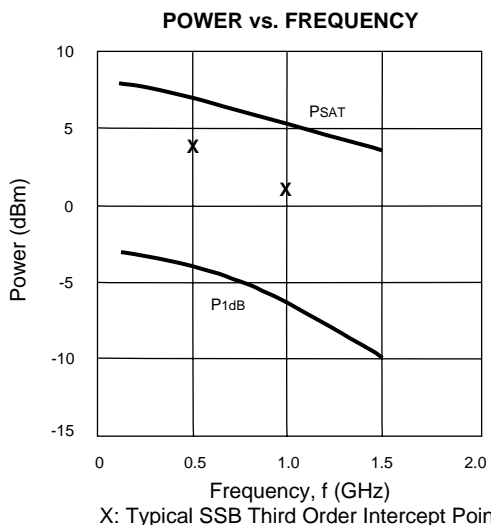
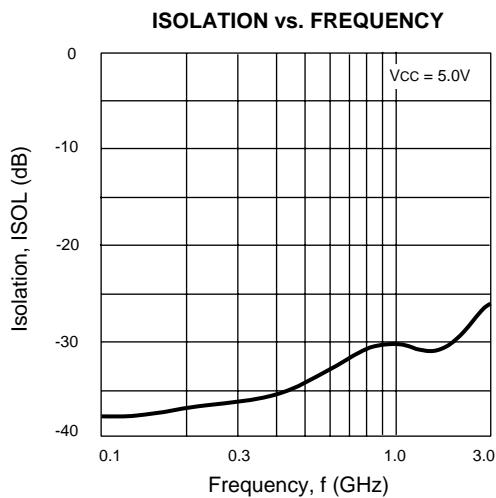

TYPICAL SCATTERING PARAMETERS (T_A = 25° C)

UPC2713T

V_{CC} = 5 V, I_{CC} = 12 mA

FREQUENCY (GHz)	S ₁₁		S ₂₁		S ₁₂		S ₂₂		K ¹	S ₂₁ (dB)
	MAG	ANG	MAG	ANG	MAG	ANG	MAG	ANG		
0.10	0.350	-21.8	21.9	-8.1	0.006	25.6	0.286	-10.3	3.07	26.8
0.20	0.290	-33.1	22.0	-25.3	0.006	24.9	0.298	-16.1	3.17	26.9
0.30	0.243	-41.7	22.1	-37.3	0.007	23.7	0.313	-25.6	2.77	26.9
0.40	0.207	-47.3	22.3	-48.6	0.007	22.4	0.327	-35.2	2.78	27.0
0.50	0.185	-50.5	22.4	-60.0	0.007	21.6	0.336	-45.4	2.78	27.0
0.60	0.176	-54.0	22.6	-72.7	0.008	20.1	0.348	-56.9	2.41	27.1
0.70	0.161	-57.5	22.8	-85.7	0.008	19.0	0.359	-69.0	2.39	27.1
0.80	0.148	-60.2	22.9	-100.7	0.009	18.3	0.366	-82.9	2.13	27.2
0.90	0.127	-63.9	22.8	-114.8	0.009	17.2	0.366	-96.8	2.15	27.2
1.00	0.111	-62.9	22.3	-132.0	0.009	16.4	0.359	-111.8	2.23	27.0
1.10	0.097	-56.5	21.6	-147.6	0.010	15.7	0.343	-126.8	2.12	26.7
1.20	0.095	-48.2	20.6	-163.1	0.010	14.4	0.320	-142.3	2.24	26.3
1.30	0.098	-40.1	18.9	-177.8	0.010	13.1	0.291	-156.6	2.47	25.5
1.40	0.110	-35.7	17.6	168.3	0.010	12.0	0.263	-171.7	2.68	24.9
1.50	0.129	-34.6	15.6	154.8	0.011	11.8	0.234	174.3	2.77	23.9
1.60	0.145	-36.2	14.2	142.7	0.012	11.2	0.208	160.8	2.81	23.0
1.70	0.161	-40.0	12.6	130.5	0.013	10.8	0.185	147.1	2.92	22.0
1.80	0.179	-44.7	11.4	120.9	0.014	9.8	0.164	132.6	3.02	21.1
1.90	0.191	-50.3	10.2	110.1	0.015	7.5	0.148	119.5	3.15	20.1
2.00	0.197	-56.1	9.3	100.8	0.016	5.5	0.137	107.4	3.23	19.4

Note:

1. K factor calculations:

$$K = \frac{1 + |\Delta|^2 - |S_{11}|^2 - |S_{22}|^2}{2 |S_{12} S_{21}|}, \quad \Delta = S_{11} S_{22} - S_{21} S_{12}$$

EQUIVALENT CIRCUIT

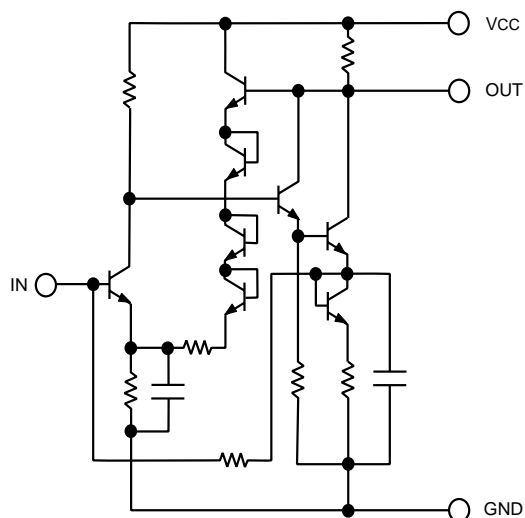

PACKAGE OUTLINE (Units in mm)

PACKAGE OUTLINE T06

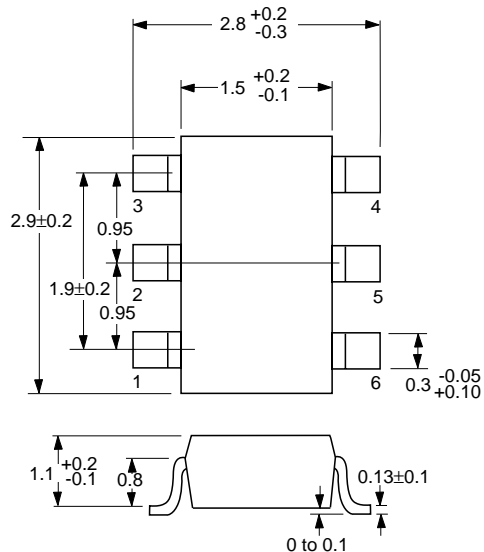

Note:
All dimensions are typical unless otherwise noted.

ORDERING INFORMATION

PART NUMBER	QTY
UPC2713T-E3	3K/Reel

Embossed Tape, 8 mm wide.

LEAD CONNECTIONS

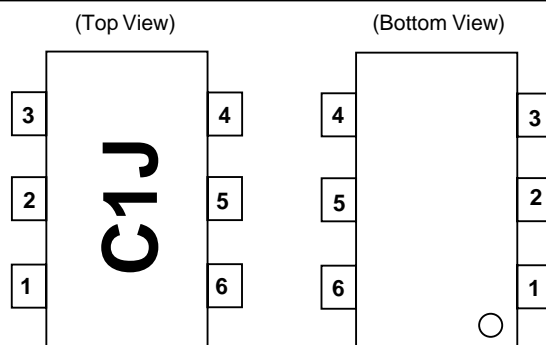

- 1. INPUT
- 2. GND
- 3. GND
- 4. OUTPUT
- 5. GND
- 6. Vcc

RECOMMENDED P.C.B. LAYOUT (Units in mm)

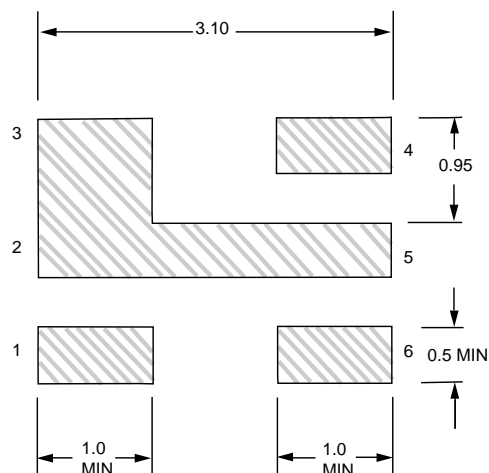

EXCLUSIVE NORTH AMERICAN AGENT FOR **NEC** RF, MICROWAVE & OPTOELECTRONIC SEMICONDUCTORS

CEL CALIFORNIA EASTERN LABORATORIES • Headquarters • 4590 Patrick Henry Drive • Santa Clara, CA 95054-1817 • (408) 988-3500 • Telex 34-6393 • FAX (408) 988-0279
24-Hour Fax-On-Demand: 800-390-3232 (U.S. and Canada only) • Internet: <http://WWW.CEL.COM>

DATA SUBJECT TO CHANGE WITHOUT NOTICE

8/02/2000