

BIPOLAR ANALOG INTEGRATED CIRCUIT

μ PC2918, 2925, 2926

THREE-TERMINAL LOW DROPOUT VOLTAGE REGULATOR

DESCRIPTION

The μ PC2918, 2925 and 2926 are three-terminal low dropout voltage regulators with the 1-A output. The μ PC2918 outputs 1.8 V, the μ PC2925 outputs 2.5 V and the μ PC2926 outputs 2.6 V. Since these regulators use a PNP transistor for the output stage, they achieve a low dropout voltage of 0.7 V TYP. at $I_o = 1$ A and minimize the power dissipation of the IC. As a result, these regulators can be used to realize sets with lower voltage and power dissipation.

FEATURES

- Output current capacity: 1 A
- Low dropout voltage
 $V_{DIF} = 0.5$ V MAX. ($I_o = 0.5$ A)
- Output voltage accuracy: $V_o \pm 2\%$
- On-chip saturation protector rising edge of input voltage (at low input voltage)
- On-chip over-current limiter and thermal protection
- On-chip output transistor safe operation area protection

<R> PIN CONFIGURATIONS (Marking Side)

μ PC2918HF,
 μ PC2925HF,
 μ PC2926HF: Isolated TO-220 (MP-45G)

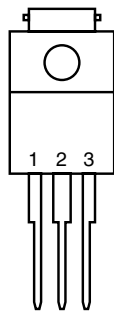

1: INPUT
 2: GND
 3: OUTPUT

μ PC2918HB,
 μ PC2925HB,
 μ PC2926HB: SC-64 (MP-3)

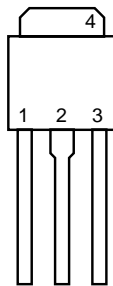

1: INPUT
 2: GND ^{Note1}
 3: OUTPUT
 4: GND (Fin)

μ PC2918T,
 μ PC2925T,
 μ PC2926T: SC-63 (MP-3Z)

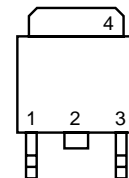

1: INPUT
 2: GND ^{Note2}
 3: OUTPUT
 4: GND (Fin)

- Notes**
1. No.2 pin and No.4 fin are common GND.
 2. No.2 pin is cut. No.2 pin and No.4 fin are common GND.

The information in this document is subject to change without notice. Before using this document, please confirm that this is the latest version.
 Not all products and/or types are available in every country. Please check with an NEC Electronics sales representative for availability and additional information.

BLOCK DIAGRAM

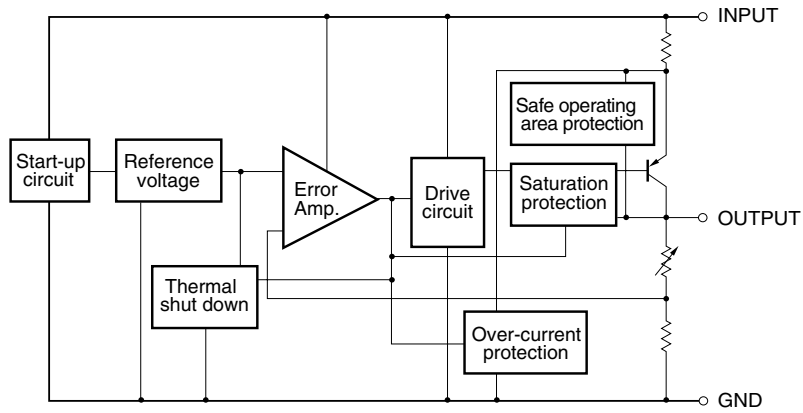

<R> ORDERING INFORMATION

Part Number	Package	Output Voltage	Marking
μPC2918HF	Isolated TO-220 (MP-45G)	1.8 V	2918
μPC2918HB	SC-64 (MP-3)	1.8 V	2918
μPC2918T	SC-63 (MP-3Z)	1.8 V	2918
μPC2925HF	Isolated TO-220 (MP-45G)	2.5 V	2925
μPC2925HB	SC-64 (MP-3)	2.5 V	2925
μPC2925T	SC-63 (MP-3Z)	2.5 V	2925
μPC2926HF	Isolated TO-220 (MP-45G)	2.6 V	2926
μPC2926HB	SC-64 (MP-3)	2.6 V	2926
μPC2926T	SC-63 (MP-3Z)	2.6 V	2926

Remark Tape-packaged products have the symbol -E1, or -E2 suffixed to the part number. Pb-free products have the symbol -AZ, or -AY suffixed to the part number. Refer to the following table for details.

Part Number ^{Note1}	Package	Package Type
μPC29xxHF	Isolated TO-220 (MP-45G)	• Packed in envelop
μPC29xxHF-AZ ^{Note2}	Isolated TO-220 (MP-45G)	• Packed in envelop
μPC29xxHB	SC-64 (MP-3)	• Packed in envelop
μPC29xxHB-AZ ^{Note2}	SC-64 (MP-3)	• Packed in envelop
μPC29xxHB-AY ^{Note3}	SC-64 (MP-3)	• Packed in envelop
μPC29xxT-E1	SC-63 (MP-3Z)	• 16 mm wide embossed taping • Pin 1 on draw-out side • 2000 pcs/reel
μPC29xxT-E1-AZ ^{Note2}	SC-63 (MP-3Z)	• 16 mm wide embossed taping • Pin 1 on draw-out side • 2000 pcs/reel
μPC29xxT-E1-AY ^{Note3}	SC-63 (MP-3Z)	• 16 mm wide embossed taping • Pin 1 on draw-out side • 2000 pcs/reel
μPC29xxT-E2	SC-63 (MP-3Z)	• 16 mm wide embossed taping • Pin 1 at take-up side • 2000 pcs/reel
μPC29xxT-E2-AZ ^{Note2}	SC-63 (MP-3Z)	• 16 mm wide embossed taping • Pin 1 at take-up side • 2000 pcs/reel
μPC29xxT-E2-AY ^{Note3}	SC-63 (MP-3Z)	• 16 mm wide embossed taping • Pin 1 at take-up side • 2000 pcs/reel

Notes 1. xx stands for symbols that indicate the output voltage.

2. Pb-free (This product does not contain Pb in the external electrode.)

3. Pb-free (This product does not contain Pb in the external electrode, Sn100% plating.)

ABSOLUTE MAXIMUM RATINGS (TA = 25°C, unless otherwise specified)

Parameter	Symbol	Rating		Unit
		μPC2918HF, μPC2925HF, μPC2926HF	μPC2918HB, μPC2925HB, μPC2926HB, μPC2918T, μPC2925T, μPC2926T	
Input Voltage	V _{IN}	20		V
Internal Power Dissipation (T _c = 25°C) ^{Note}	P _T	15	10	W
Operating Ambient Temperature	T _A	-30 to +85		°C
Operating Junction Temperature	T _J	-30 to +150		°C
Storage Temperature	T _{stg}	-55 to +150		°C
Thermal Resistance (junction to case)	R _{th(J-C)}	7	12.5	°C/W
Thermal Resistance (junction to ambient)	R _{th(J-A)}	65	125	°C/W

Note Internally limited. When the operating junction temperature rises above 150°C, the internal circuit shuts down the output voltage.

Caution Product quality may suffer if the absolute maximum rating is exceeded even momentarily for any parameter. That is, the absolute maximum ratings are rated values at which the product is on the verge of suffering physical damage, and therefore the product must be used under conditions that ensure that the absolute maximum ratings are not exceeded.

TYPICAL CONNECTION

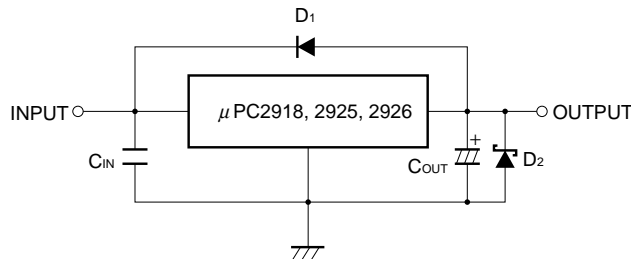

C_{IN} : 0.1 μF or higher. Be sure to connect C_{IN} to prevent parasitic oscillation. Set this value according to the length of the line between the regulator and the INPUT pin. Use of a film capacitor or other capacitor with first-rate voltage and temperature characteristics is recommended. If using a laminated ceramic capacitor, it is necessary to ensure that C_{IN} is 0.1 μF or higher for the voltage and temperature range to be used.

C_{OUT}: 10 μF or higher. Be sure to connect C_{OUT} to prevent oscillation and improve excessive load regulation. Place C_{IN} and C_{OUT} as close as possible to the IC pins (within 1 to 2 cm). Also, use an electrolytic capacitor with low impedance characteristics if considering use at sub-zero temperatures.

D₁ : If the OUTPUT pin has a higher voltage than the INPUT pin, connect a diode.

D₂ : If the OUTPUT pin has a lower voltage than the GND pin, connect a Schottky barrier diode.

Caution Make sure that no voltage is applied to the OUTPUT pin from external.

RECOMMENDED OPERATING CONDITIONS

Parameter	Symbol	Type Number	MIN.	TYP.	MAX.	Unit
Input Voltage	V _{IN}	μPC2918	2.8		16	V
		μPC2925	3.5		16	V
		μPC2926	3.6		16	V
Output Current	I _o	All	0		1	A
Operating Ambient Temperature	T _A	All	-30		+85	°C
Operating Junction Temperature	T _J	All	-30		+125	°C

Caution Use of conditions other than the above-listed recommended operating conditions is not a problem as long as the absolute maximum ratings are not exceeded. However, since the use of such conditions diminishes the margin of safety, careful evaluation is required before such conditions are used. Moreover, using the MAX. value for all the recommended operating conditions is not guaranteed to be safe.

ELECTRICAL CHARACTERISTICS

μPC2918 (T_J = 25°C, V_{IN} = 2.8 V, I_o = 0.5 A, C_{IN} = 0.1 μF, C_{OUT} = 10 μF, unless otherwise specified)

Parameter	Symbol	Conditions	MIN.	TYP.	MAX.	Unit
Output Voltage	V _o		1.764	1.8	1.836	V
		2.8 V ≤ V _{IN} ≤ 5 V, 0 A ≤ I _o ≤ 1 A, 0°C ≤ T _J ≤ 125°C	(1.71)		(1.854)	V
Line Regulation	REG _{IN}	2.8 V ≤ V _{IN} ≤ 16 V		6	25	mV
Load Regulation	REG _L	0 A ≤ I _o ≤ 1 A		7	30	mV
Quiescent Current	I _{BIAS}	I _o = 0 A		2	4	mA
		I _o = 1 A		20	60	mA
Startup Quiescent Current	I _{BIAS(S)}	V _{IN} = 2.4 V, I _o = 0 A		10	30	mA
		V _{IN} = 2.4 V, I _o = 1 A			80	mA
Quiescent Current Change	ΔI _{BIAS}	2.8 V ≤ V _{IN} ≤ 16 V, 0°C ≤ T _J ≤ 125°C		2.9	20	mA
Output Noise Voltage	V _n	10 Hz ≤ f ≤ 100 kHz		40		μV _{r.m.s.}
Ripple Rejection	R•R	f = 120 Hz, 2.8 V ≤ V _{IN} ≤ 9 V	45	60		dB
Dropout Voltage	V _{DIF}	I _o = 0.5 A		0.25	0.5	V
		I _o = 1 A, 0°C ≤ T _J ≤ 125°C		0.7		V
Short Circuit Current	I _o short	V _{IN} = 2.8 V	1.2	1.7	3.0	A
		V _{IN} = 16 V		1.2		A
Peak Output Current	I _o peak	V _{IN} = 2.8 V	1.0	1.5	3.0	A
		V _{IN} = 16 V		1.1		A
Temperature Coefficient of Output Voltage	ΔV _o /ΔT	I _o = 5 mA, 0°C ≤ T _J ≤ 125°C		-0.4		mV/°C

Remark Values in parentheses have been measured during product design and are provided as reference values.

μPC2925 (T_J = 25°C, V_{IN} = 3.5 V, I_o = 0.5 A, C_{IN} = 0.1 μF, C_{OUT} = 10 μF, unless otherwise specified)

Parameter	Symbol	Conditions	MIN.	TYP.	MAX.	Unit
Output Voltage	V _o		2.45	2.5	2.55	V
		3.5 V ≤ V _{IN} ≤ 5 V, 0 A ≤ I _o ≤ 1 A, 0°C ≤ T _J ≤ 125°C	(2.375)		(2.575)	V
Line Regulation	REG _{IN}	3.5 V ≤ V _{IN} ≤ 16 V		6	25	mV
Load Regulation	REG _L	0 A ≤ I _o ≤ 1 A		7	30	mV
Quiescent Current	I _{BIAS}	I _o = 0 A		2	4	mA
		I _o = 1 A		20	60	mA
Startup Quiescent Current	I _{BIAS(S)}	V _{IN} = 2.4 V, I _o = 0 A		10	30	mA
		V _{IN} = 3.0 V, I _o = 1 A			80	mA
Quiescent Current Change	ΔI _{BIAS}	3.5 V ≤ V _{IN} ≤ 16 V, 0°C ≤ T _J ≤ 125°C		2.9	20	mA
Output Noise Voltage	V _n	10 Hz ≤ f ≤ 100 kHz		40		μV _{r.m.s.}
Ripple Rejection	R•R	f = 120 Hz, 3.5 V ≤ V _{IN} ≤ 9 V	45	60		dB
Dropout Voltage	V _{DIF}	I _o = 0.5 A		0.25	0.5	V
		I _o = 1 A, 0°C ≤ T _J ≤ 125°C		0.7		V
Short Circuit Current	I _{short}	V _{IN} = 3.5 V	1.2	1.7	3.0	A
		V _{IN} = 16 V		1.2		A
Peak Output Current	I _{Opeak}	V _{IN} = 3.5 V	1.0	1.5	3.0	A
		V _{IN} = 16 V		1.1		A
Temperature Coefficient of Output Voltage	ΔV _o /ΔT	I _o = 5 mA, 0°C ≤ T _J ≤ 125°C		-0.5		mV/°C

Remark Values in parentheses have been measured during product design and are provided as reference values.

μPC2926 (T_J = 25°C, V_{IN} = 3.6 V, I_o = 0.5 A, C_{IN} = 0.1 μF, C_{OUT} = 10 μF, unless otherwise specified)

Parameter	Symbol	Conditions	MIN.	TYP.	MAX.	Unit
Output Voltage	V _o		2.548	2.6	2.652	V
		3.6 V ≤ V _{IN} ≤ 5 V, 0 A ≤ I _o ≤ 1 A, 0°C ≤ T _J ≤ 125°C	(2.470)		(2.678)	V
Line Regulation	REG _{IN}	3.6 V ≤ V _{IN} ≤ 16 V		6	25	mV
Load Regulation	REG _L	0 A ≤ I _o ≤ 1 A		7	30	mV
Quiescent Current	I _{BIAS}	I _o = 0 A		2	4	mA
		I _o = 1 A		20	60	mA
Startup Quiescent Current	I _{BIAS(S)}	V _{IN} = 2.4 V, I _o = 0 A		10	30	mA
		V _{IN} = 3.0 V, I _o = 1 A			80	mA
Quiescent Current Change	ΔI _{BIAS}	3.6 V ≤ V _{IN} ≤ 16 V, 0°C ≤ T _J ≤ 125°C		2.9	20	mA
Output Noise Voltage	V _n	10 Hz ≤ f ≤ 100 kHz		40		μV _{r.m.s.}
Ripple Rejection	R•R	f = 120 Hz, 3.6 V ≤ V _{IN} ≤ 9 V	45	60		dB
Dropout Voltage	V _{DIF}	I _o = 0.5 A		0.25	0.5	V
		I _o = 1 A, 0°C ≤ T _J ≤ 125°C		0.7		V
Short Circuit Current	I _{short}	V _{IN} = 3.6 V	1.2	1.7	3.0	A
		V _{IN} = 16 V		1.2		A
Peak Output Current	I _{Opeak}	V _{IN} = 3.6 V	1.0	1.5	3.0	A
		V _{IN} = 16 V		1.1		A
Temperature Coefficient of Output Voltage	ΔV _o /ΔT	I _o = 5 mA, 0°C ≤ T _J ≤ 125°C		-0.5		mV/°C

Remark Values in parentheses have been measured during product design and are provided as reference values.

TYPICAL CHARACTERISTICS (Reference Values)

<R>

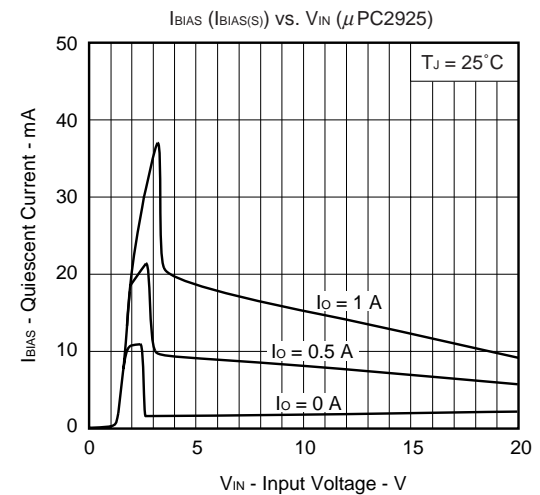
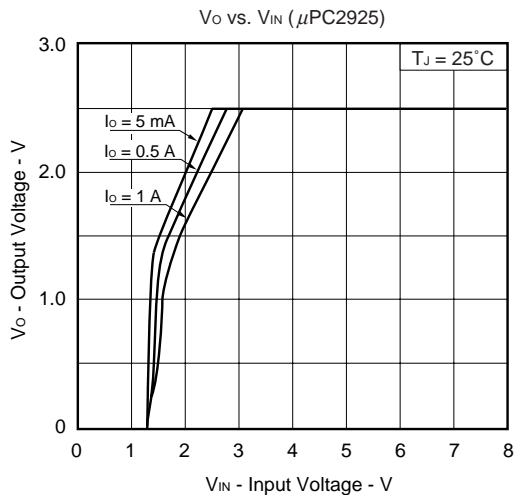
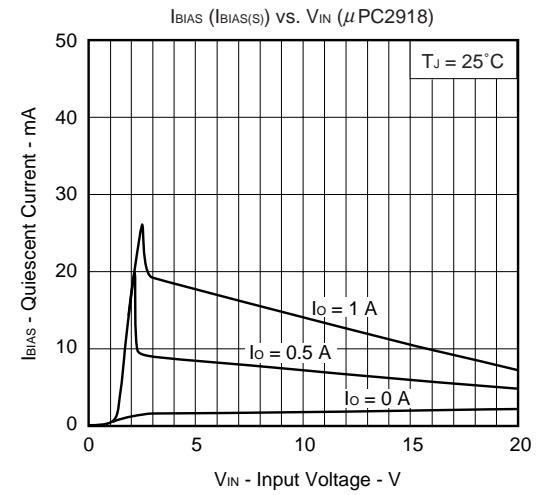
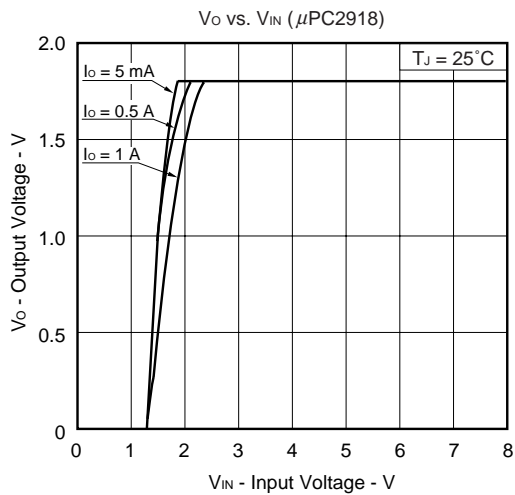
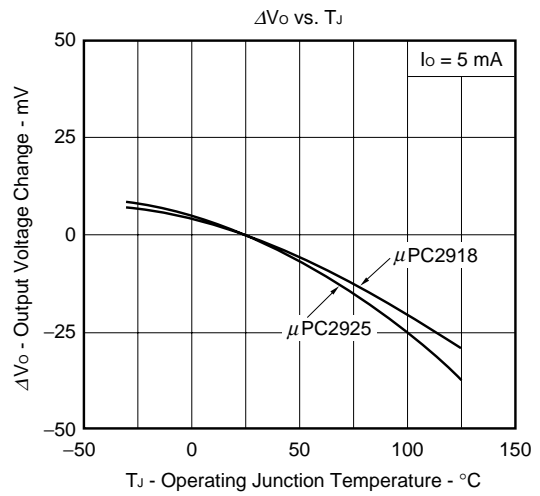
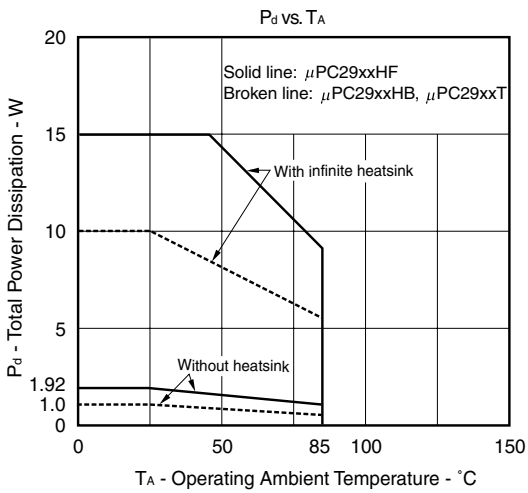

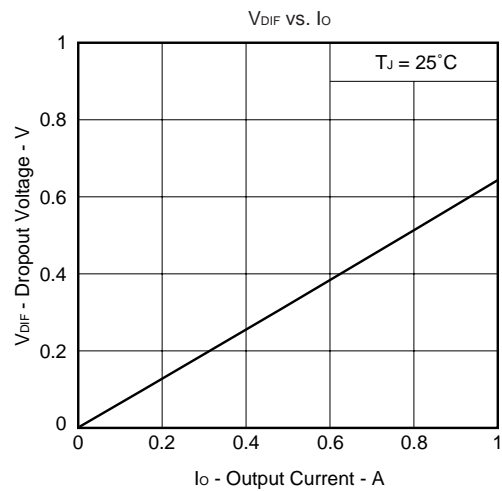
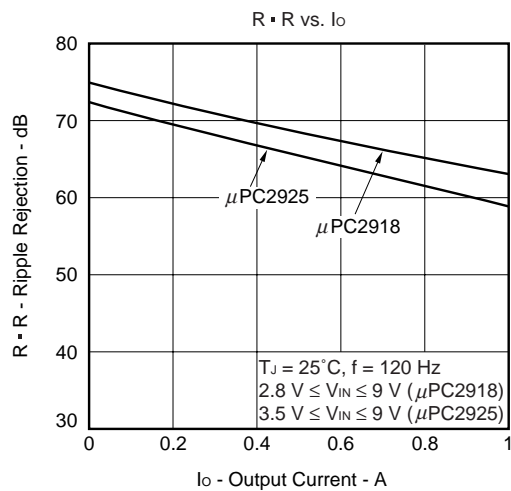
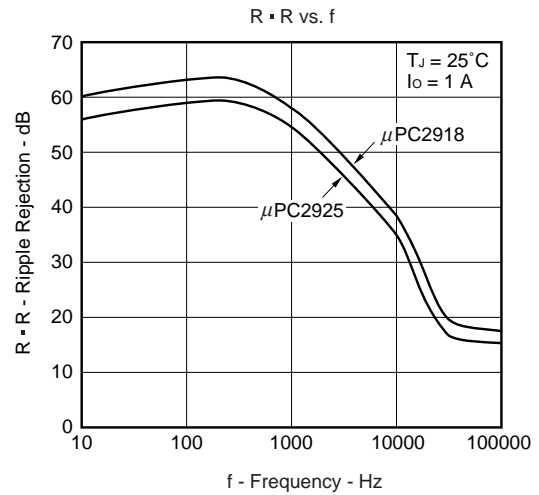
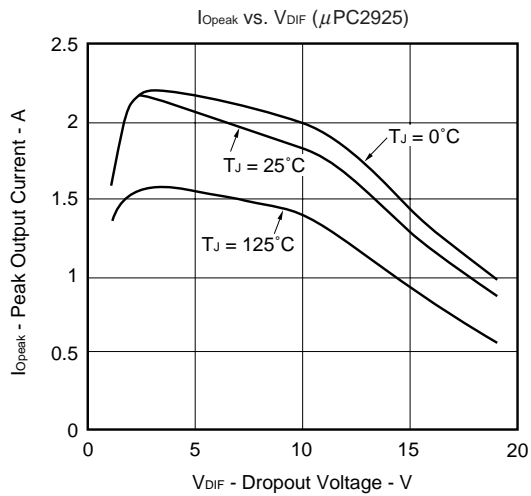
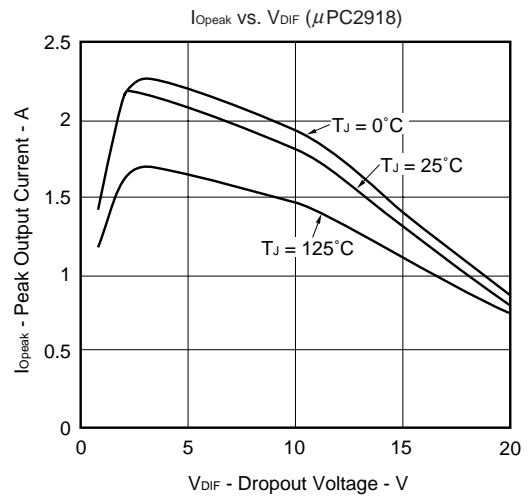
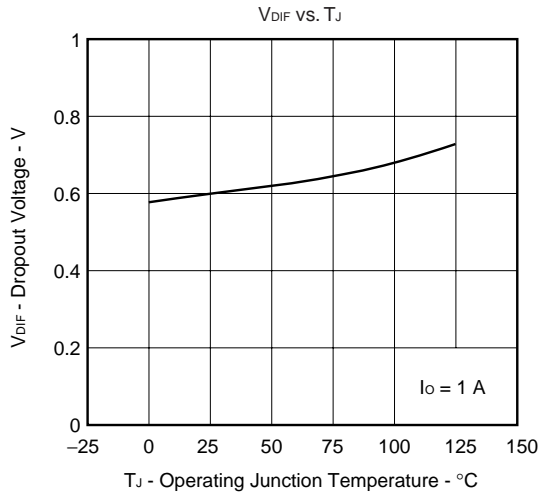

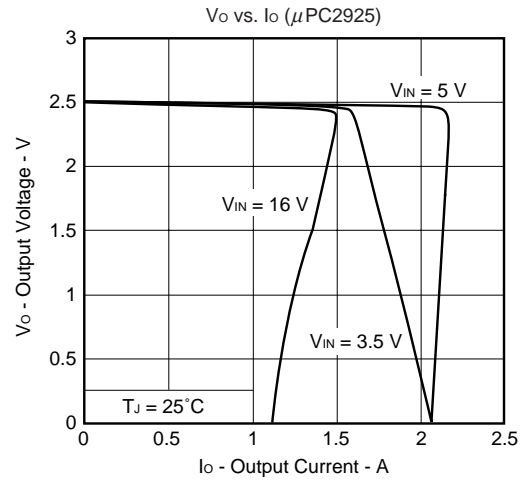
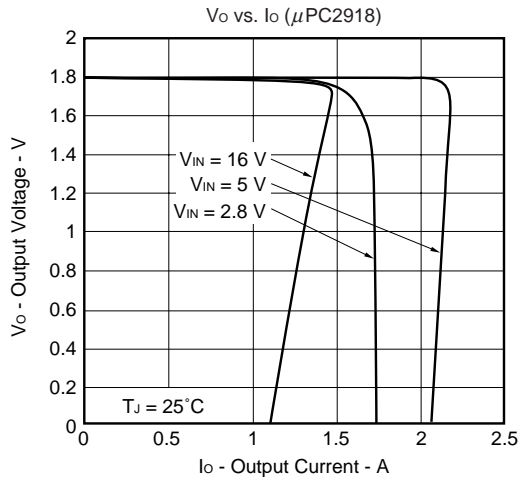

PACKAGE DRAWINGS

μPC2918HF, μPC2925HF, μPC2926HF

3PIN PLASTIC SIP (MP-45G)

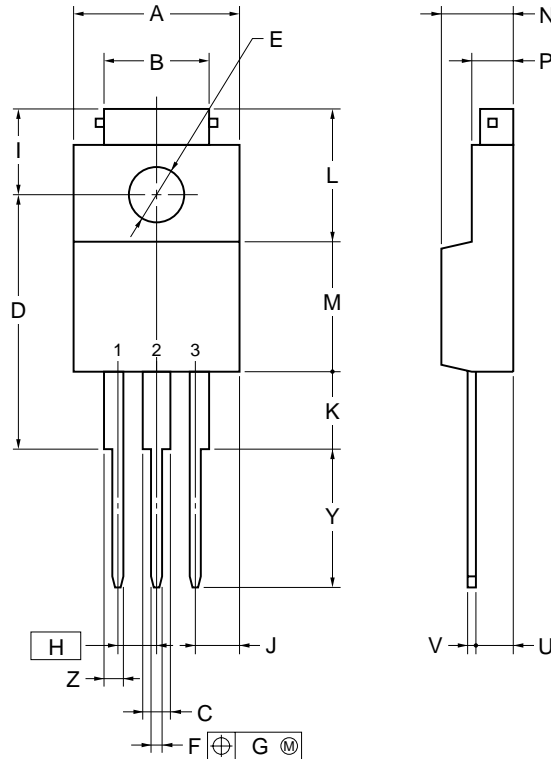

NOTE

Each lead centerline is located within 0.25 mm of its true position (T.P.) at maximum material condition.

ITEM	MILLIMETERS
A	10.0±0.2
B	7.0±0.2
C	1.50±0.2
D	17.0±0.3
E	φ3.3±0.2
F	0.75±0.10
G	0.25
H	2.54 (T.P.)
I	5.0±0.3
J	2.46±0.2
K	5.0±0.2
L	8.5±0.2
M	8.5±0.2
N	4.5±0.2
P	2.8±0.2
U	2.4±0.5
V	0.65±0.10
Y	8.9±0.7
Z	1.30±0.2

P3HF-254B-4

μPC2918HB, μPC2925HB, μPC2926HB

SC-64 (MP-3) (Unit: mm)

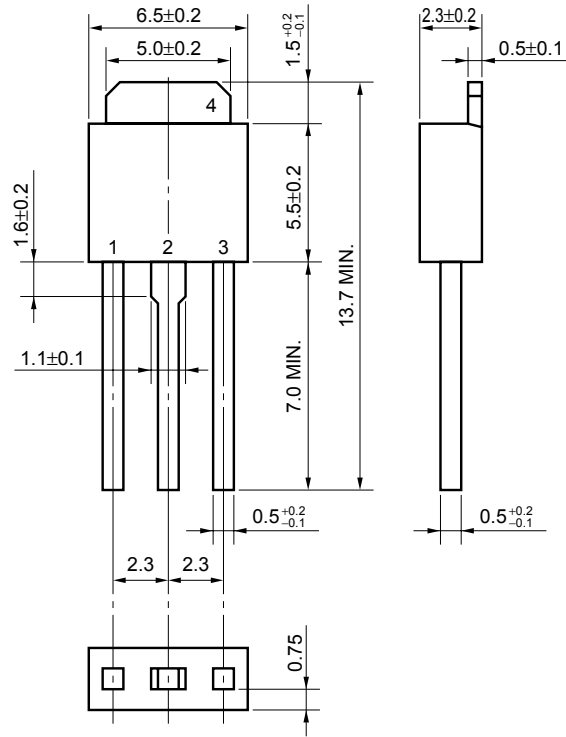

μPC2918T, μPC2925T, μPC2926T

<R> SC-63 (MP-3Z) (Unit: mm)

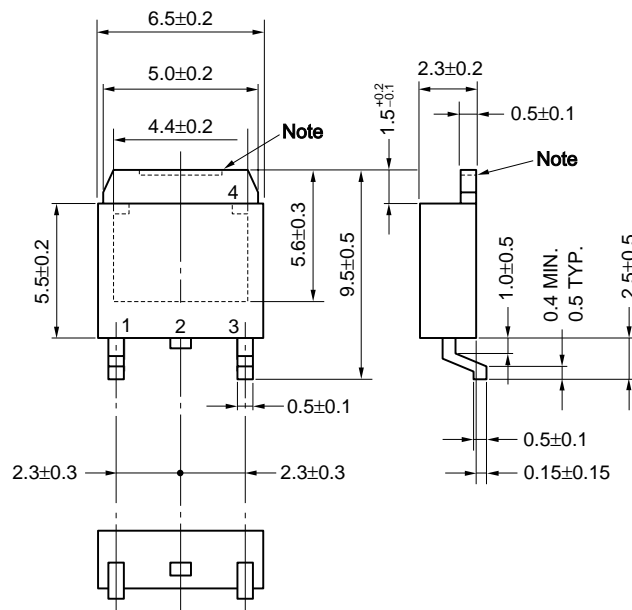

Note The depth of notch at the top of the fin is from 0 to 0.2 mm.

<R> **RECOMMENDED SOLDERING CONDITIONS**

The μPC2918, 2925 and 2926 should be soldered and mounted under the following recommended conditions.
 For soldering methods and conditions other than those recommended below, contact an NEC Electronics sales representative.
 For technical information, see the following website.

Semiconductor Device Mount Manual (<http://www.necel.com/pkg/en/mount/index.html>)

Surface Mount Device

μPC29xxT Series: SC-63 (MP-3Z)

Process	Conditions	Symbol
Infrared Ray Reflow	Peak temperature: 235°C or below (Package surface temperature), Reflow time: 30 seconds or less (at 210°C or higher), Maximum number of reflow processes: 3 times or less.	IR35-00-3
Vapor Phase Soldering	Peak temperature: 215°C or below (Package surface temperature), Reflow time: 40 seconds or less (at 200°C or higher), Maximum number of reflow processes: 3 times or less.	VP15-00-3
Partial Heating Method	Pin temperature: 350°C or below, Heat time: 3 seconds or less (Per each side of the device).	P350

μPC29xxT-AZ Series ^{Note1}, μPC29xxT-AY Series ^{Note2}: SC-63 (MP-3Z)

Process	Conditions	Symbol
Infrared Ray Reflow	Peak temperature: 260°C or below (Package surface temperature), Reflow time: 60 seconds or less (at 220°C or higher), Maximum number of reflow processes: 3 times or less.	IR60-00-3
Partial Heating Method	Pin temperature: 350°C or below, Heat time: 3 seconds or less (Per each side of the device).	P350

- Notes**
1. Pb-free (This product does not contain Pb in the external electrode.)
 2. Pb-free (This product does not contain Pb in the external electrode, Sn100% plating.)

Caution Apply only one kind of soldering condition to a device, except for "partial heating method", or the device will be damaged by heat stress.

Remark Flux: Rosin-based flux with low chlorine content (chlorine 0.2 Wt% or below) is recommended.

Through-hole devices

μPC29xxHF Series, μPC29xxHF-AZ Series ^{Note1}: Isolated TO-220 (MP-45G)

μPC29xxHB Series, μPC29xxHB-AZ Series ^{Note1}, μPC29xxHB-AY Series ^{Note2}: SC-64 (MP-3)

Process	Conditions	Symbol
Wave soldering (only to leads)	Solder temperature: 260°C or below, Flow time: 10 seconds or less.	WS60-00-1
Partial heating method	Pin temperature: 350°C or below, Heat time: 3 seconds or less (Per each pin).	P350

Notes 1. Pb-free (This product does not contain Pb in the external electrode.)

2. Pb-free (This product does not contain Pb in the external electrode, Sn100% plating.)

Caution For through-hole device, the wave soldering process must be applied only to leads, and make sure that the package body does not get jet soldered.

NOTES ON USE

When the μPC2918, 2925 and 2926 are used with an input voltage that is lower than the value indicated in the recommended operating conditions, a high quiescent current flows through the device due to saturation of the transistor of the output stage. (Refer to the “I_{BIAS} (I_{BIAS(S)}) vs. V_{IN} curves in TYPICAL CHARACTERISTICS”).

These products have saturation protector, but a current of up to 80 mA MAX. may flow through the device. Thus the power supply on the input side must have sufficient capacity to allow this quiescent current to pass when the device starts up.

REFERENCE DOCUMENTS

	USER'S MANUAL USAGE OF THREE TERMINAL REGULATORS	Document No.G12702E
	INFORMATION VOLTAGE REGULATOR OF SMD	Document No.G11872E
<R>	REVIEW OF QUALITY AND RELIABILITY HANDBOOK	Document No.C12769E
	SEMICONDUCTOR DEVICE MOUNT MANUAL	http://www.necel.com/pkg/en/mount/index.html

• **The information in this document is current as of August, 2007. The information is subject to change without notice. For actual design-in, refer to the latest publications of NEC Electronics data sheets or data books, etc., for the most up-to-date specifications of NEC Electronics products. Not all products and/or types are available in every country. Please check with an NEC Electronics sales representative for availability and additional information.**

• No part of this document may be copied or reproduced in any form or by any means without the prior written consent of NEC Electronics. NEC Electronics assumes no responsibility for any errors that may appear in this document.

• NEC Electronics does not assume any liability for infringement of patents, copyrights or other intellectual property rights of third parties by or arising from the use of NEC Electronics products listed in this document or any other liability arising from the use of such products. No license, express, implied or otherwise, is granted under any patents, copyrights or other intellectual property rights of NEC Electronics or others.

• Descriptions of circuits, software and other related information in this document are provided for illustrative purposes in semiconductor product operation and application examples. The incorporation of these circuits, software and information in the design of a customer's equipment shall be done under the full responsibility of the customer. NEC Electronics assumes no responsibility for any losses incurred by customers or third parties arising from the use of these circuits, software and information.

• While NEC Electronics endeavors to enhance the quality, reliability and safety of NEC Electronics products, customers agree and acknowledge that the possibility of defects thereof cannot be eliminated entirely. To minimize risks of damage to property or injury (including death) to persons arising from defects in NEC Electronics products, customers must incorporate sufficient safety measures in their design, such as redundancy, fire-containment and anti-failure features.

• NEC Electronics products are classified into the following three quality grades: "Standard", "Special" and "Specific".

The "Specific" quality grade applies only to NEC Electronics products developed based on a customer-designated "quality assurance program" for a specific application. The recommended applications of an NEC Electronics product depend on its quality grade, as indicated below. Customers must check the quality grade of each NEC Electronics product before using it in a particular application.

"Standard": Computers, office equipment, communications equipment, test and measurement equipment, audio and visual equipment, home electronic appliances, machine tools, personal electronic equipment and industrial robots.

"Special": Transportation equipment (automobiles, trains, ships, etc.), traffic control systems, anti-disaster systems, anti-crime systems, safety equipment and medical equipment (not specifically designed for life support).

"Specific": Aircraft, aerospace equipment, submersible repeaters, nuclear reactor control systems, life support systems and medical equipment for life support, etc.

The quality grade of NEC Electronics products is "Standard" unless otherwise expressly specified in NEC Electronics data sheets or data books, etc. If customers wish to use NEC Electronics products in applications not intended by NEC Electronics, they must contact an NEC Electronics sales representative in advance to determine NEC Electronics' willingness to support a given application.

(Note)

(1) "NEC Electronics" as used in this statement means NEC Electronics Corporation and also includes its majority-owned subsidiaries.

(2) "NEC Electronics products" means any product developed or manufactured by or for NEC Electronics (as defined above).