

# SG2010

# 150mA, Low Power, Low Dropout, Linear Regulators

## GENERAL DESCRIPTION

The SG2010 low-power, low-dropout, CMOS linear voltage regulator operates from 2.5V to 5.5V input and delivers up to 150mA. It is the perfect choice for low voltage, low power applications. An ultra low ground current (100 $\mu$ A at 150mA output ) makes this part attractive for battery operated power systems. The SG2010 series also offers ultra low dropout voltage (105mV at 150mA output) to prolong battery life in portable electronics.

The output voltage is preset to voltages in the range of 1.5V to 5.0V. Other features include foldback current limit and thermal shut-down protection.

SG2010 comes in 3-pin SOT23 package and 3-pin SOT89 package.

## APPLICATIONS

- Cellular Telephones
- Digital Cameras
- MP3、MP4
- USB 2.0
- Modems
- PC Cameras
- Hand-Held Instruments
- Electronic Dictionaries
- Portable/Battery-Powered Equipment

## FEATURES

- Ultra-Low Dropout Voltage:  
105mV at 150mA output
- Low 80 $\mu$ A No-Load Supply Current
- Low 100 $\mu$ A Operating Supply Current at 150mA Output
- Thermal-Overload Protection
- Output Current Limit
- Preset Output Voltages ( $\pm 1.8\%$  Accuracy)
- Output Voltage:  
Available in Fixed Outputs of 1.5V, 1.8V, 2.5V, 2.8V, 3.0V, and 3.3V

## PIN CONFIGURATIONS (TOP VIEW)

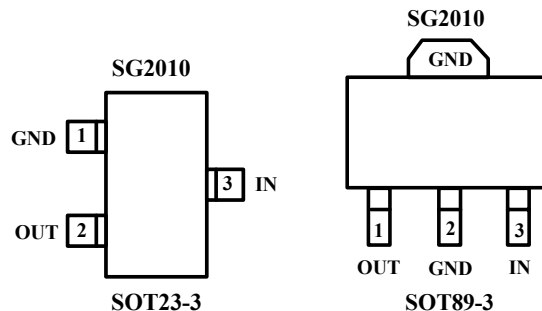

## TYPICAL OPERATION CIRCUIT

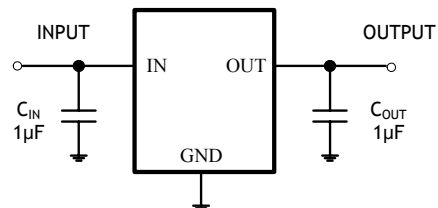

Shengbang Microelectronics Co, Ltd  
Tel: 86/451/84348461  
www.sg-micro.com

REV. B

## ORDERING INFORMATION

MODEL	V <sub>OUT</sub> (V)	PIN-PACKAGE	SPECIFIED TEMPERATURE RANGE	ORDERING NUMBER	PACKAGE MARKING	PACKAGE OPTION
SG2010-1.5	1.5V	SOT23-3	- 40°C to +125°C	SG2010-1.5XN3/TR	XA15	Tape and Reel, 3000
		SOT89-3		SG2010-1.5XK3/TR	SG2010-1.5XK3	Tape and Reel, 1000
SG2010-1.8	1.8V	SOT23-3	- 40°C to +125°C	SG2010-1.8XN3/TR	XA18	Tape and Reel, 3000
		SOT89-3		SG2010-1.8XK3/TR	SG2010-1.8XK3	Tape and Reel, 1000
SG2010-2.5	2.5V	SOT23-3	- 40°C to +125°C	SG2010-2.5XN3/TR	XA25	Tape and Reel, 3000
		SOT89-3		SG2010-2.5XK3/TR	SG2010-2.5XK3	Tape and Reel, 1000
SG2010-2.8	2.8V	SOT23-3	- 40°C to +125°C	SG2010-2.8XN3/TR	XA28	Tape and Reel, 3000
		SOT89-3		SG2010-2.8XK3/TR	SG2010-2.8XK3	Tape and Reel, 1000
SG2010-3.0	3.0V	SOT23-3	- 40°C to +125°C	SG2010-3.0XN3/TR	XA30	Tape and Reel, 3000
		SOT89-3		SG2010-3.0XK3/TR	SG2010-3.0XK3	Tape and Reel, 1000
SG2010-3.3	3.3V	SOT23-3	- 40°C to +125°C	SG2010-3.3XN3/TR	XA33	Tape and Reel, 3000
		SOT89-3		SG2010-3.3XK3/TR	SG2011-3.3XK3	Tape and Reel, 1000

## ABSOLUTE MAXIMUM RATINGS

IN to GND.....- 0.3V to +6V  
 Output Short-Circuit Duration.....Infinite  
 OUT to GND.....- 0.3V to (V<sub>IN</sub> + 0.3V)  
 Power Dissipation, P<sub>d</sub> @ T<sub>A</sub> = 25°C  
 SOT23-3 .....0.4W  
 SOT89-3 .....0.571W  
 Package Thermal Resistance  
 SOT23-3, θ<sub>JA</sub>..... 250°C/W

SOT89-3, θ<sub>JA</sub>.....175°C/W  
 Operating Temperature Range.....- 40°C to +125°C  
 Junction Temperature.....+150°C  
 Storage Temperature.....- 65°C to +150°C  
 Lead Temperature (soldering, 10s).....260°C  
 ESD Susceptibility  
 HBM.....7000V  
 MM.....400V

Stresses beyond those listed under “Absolute Maximum Ratings” may cause permanent damage to the device. These are stress ratings only, and functional operation of the device at these or any other conditions beyond those indicated in the operational sections of the specifications is not implied. Exposure to absolute maximum rating conditions for extended periods may affect device reliability.

## PIN DESCRIPTION

NAME	FUNCTION
IN	Regulator Input. Supply voltage can range from 2.5V to 5.5V.
GND	Ground.
OUT	Regulator Output.

# ELECTRICAL CHARACTERISTICS

( $V_{IN} = V_{OUT(NOMINAL)} + 0.5V$  or  $2.5V$  (whichever is greater),  $T_A = -40^{\circ}C$  to  $+125^{\circ}C$ , unless otherwise noted. Typical values are at  $T_A = +25^{\circ}C$ .)

PARAMETER	SYMBOL	CONDITIONS	MIN	TYP	MAX	UNITS
Input Voltage	$V_{IN}$		2.5		5.5	V
Output Voltage Accuracy		$I_{OUT} = 0.1mA$ , $T_A = +25^{\circ}C$	-1.8		1.8	%
		$I_{OUT} = 0.1mA$ to $150mA$ , $T_A = 0^{\circ}C$ to $+70^{\circ}C$			2.2	
		$I_{OUT} = 0.1mA$ to $150mA$ , $T_A = -40^{\circ}C$ to $+125^{\circ}C$			2.6	
Output Current			150			mA
Current Limit	$I_{LIM}$		160	600		mA
Ground Pin Current	$I_Q$	No load		80	130	$\mu A$
		$I_{OUT} = 150mA$		100		
Dropout Voltage(Note1)		$I_{OUT} = 1mA$		0.8		mV
		$I_{OUT} = 150mA$		105	170	
Line Regulation	$\Delta V_{LNR}$	$V_{IN} = 2.5V$ or ( $V_{OUT} + 0.1V$ ) to $5.5V$ , $I_{OUT} = 1mA$		0.004	0.15	%/V
Load Regulation	$\Delta V_{LDR}$	$I_{OUT} = 0.1mA$ to $500mA$ , $C_{OUT} = 1\mu F$		0.0005	0.002	%/mA
Output Voltage Noise	$e_n$	$f = 10Hz$ to $100KHz$ , $C_{OUT} = 10\mu F$		120		$\mu VRMS$
Power Supply Rejection Rate	PSRR	$I_{LOAD} = 50mA$ , $C_{OUT} = 1\mu F$	$f = 100Hz$ ,	74		dB
			$f = 1KHz$ ,	54		dB
<b>THERMAL PROTECTION</b>						
Thermal Shutdown Temperature	$T_{SHDN}$			160		$^{\circ}C$
Thermal Shutdown Hysteresis	$\Delta T_{SHDN}$			15		$^{\circ}C$

Specifications subject to change without notice.

**Note 1:** The dropout voltage is defined as  $V_{IN} - V_{OUT}$ , when  $V_{OUT}$  is  $100mV$  below the value of  $V_{OUT}$  for  $V_{IN} = V_{OUT} + 0.5V$ . (Only applicable for  $V_{OUT} = +2.5V$  to  $+5.0V$ )

# TYPICAL OPERATING CHARACTERISTICS

$V_{IN} = V_{OUT(NOMINAL)} + 0.5V$  or  $2.5V$  (whichever is greater),  $C_{IN} = 1\mu F$ ,  $C_{OUT} = 1\mu F$ ,  $T_A = +25^\circ C$ , unless otherwise noted.

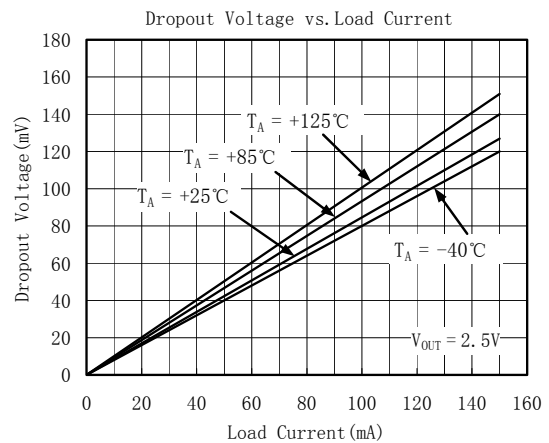
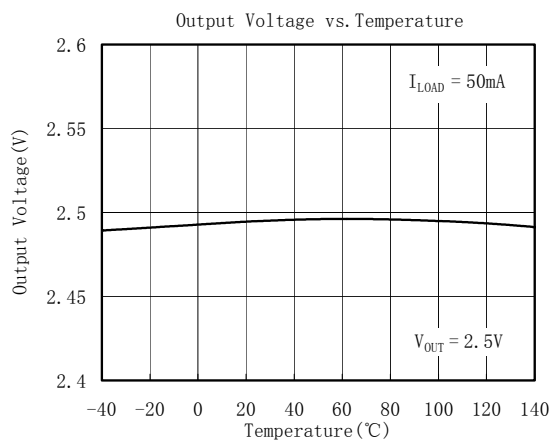
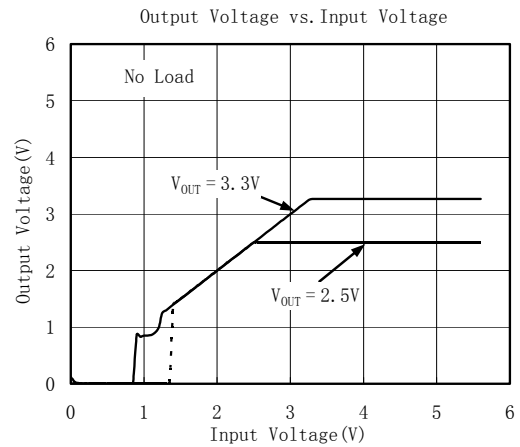
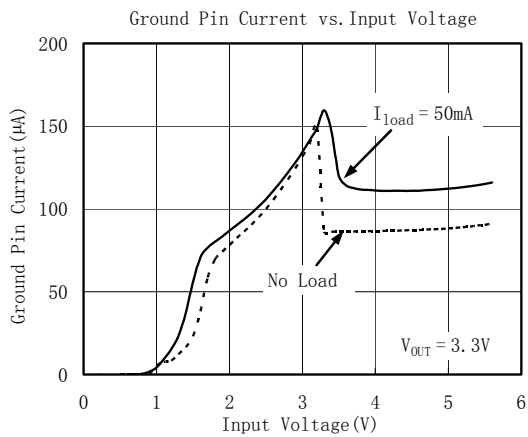
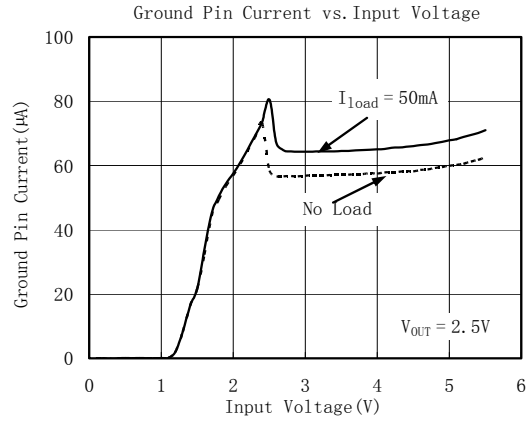
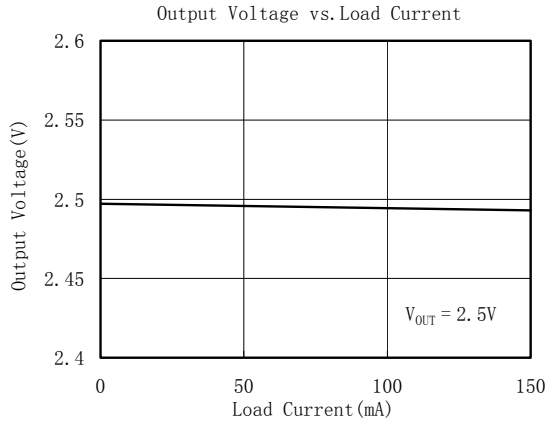

# TYPICAL OPERATING CHARACTERISTICS

$V_{IN} = V_{OUT(NOMINAL)} + 0.5V$  or  $2.5V$  (whichever is greater),  $C_{IN} = 1\mu F$ ,  $C_{OUT} = 1\mu F$ ,  $T_A = +25^\circ C$ , unless otherwise noted.

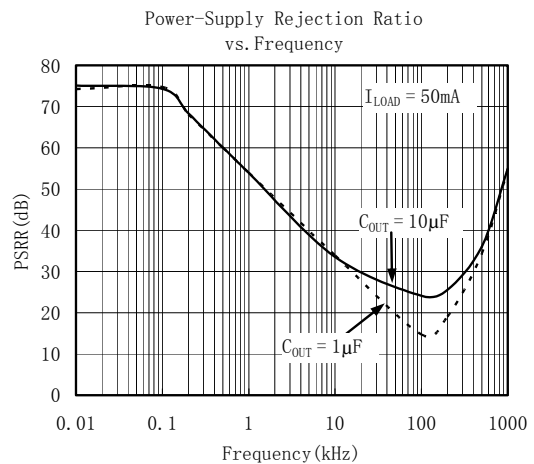
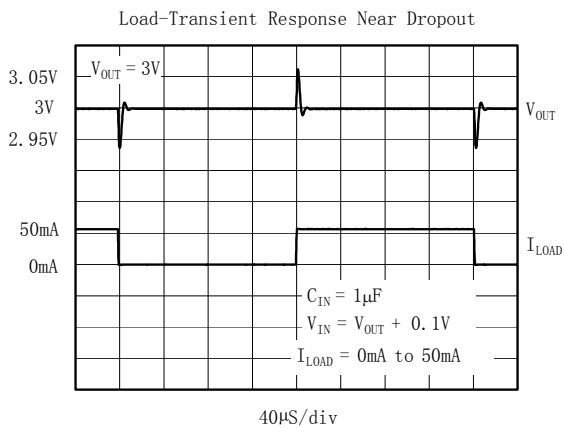
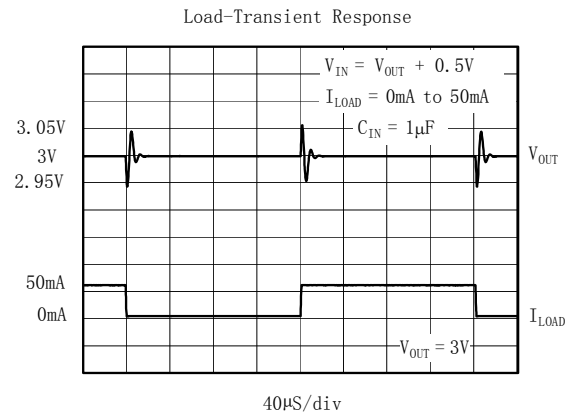
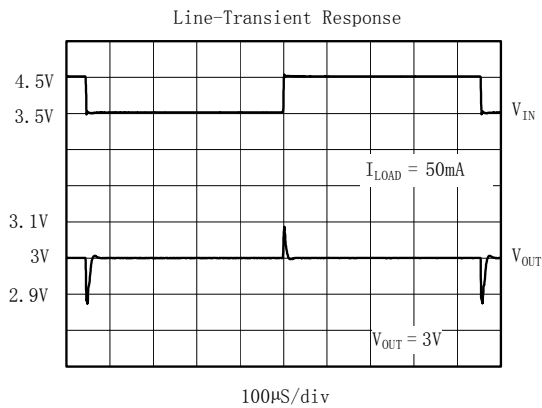
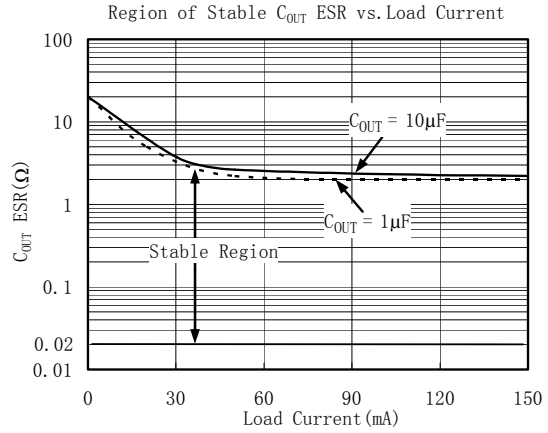
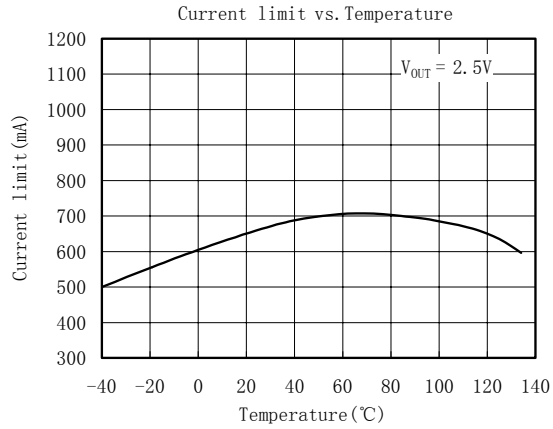

## Application Notes

When LDO is used in handheld products, Attention must be paid to voltage spike which would damage SG2010. In such applications, voltage spike will be generated at charger interface and  $V_{BUS}$  pin of USB interface when charger adapters and USB equipments are hot-inserted. Besides this, handheld products will be tested on the production line on the condition of no battery. Test Engineer will apply power from the connector pin which connects with positive pole of the battery. When external power supply is turned on suddenly, the voltage spike will be generated at the battery connector. The voltage spike will be very high, it always exceeds the absolute maximum input voltage (6.0V) of LDO. In order to get robust design. Design Engineer needs to clear up this voltage spike. Zener diode is a cheap and effective solution to eliminate such voltage spike. For example, BZM55B5V6 is a 5.6V small package Zener diode which can be used to remove voltage spike in cell phone design. The schematic is shown in below:

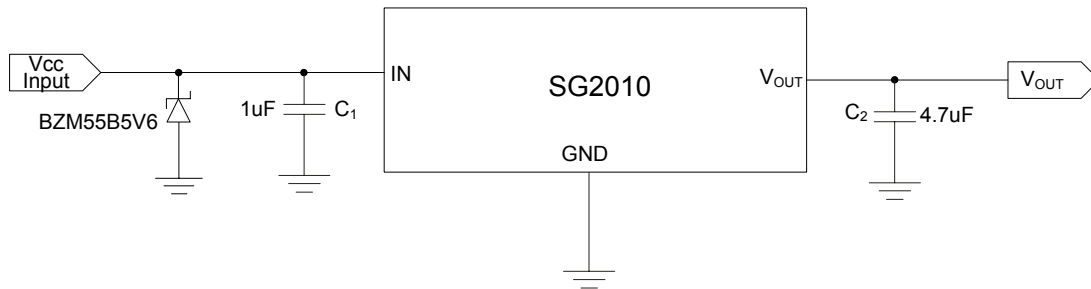

# PACKAGE OUTLINE DIMENSIONS

## SOT23-3

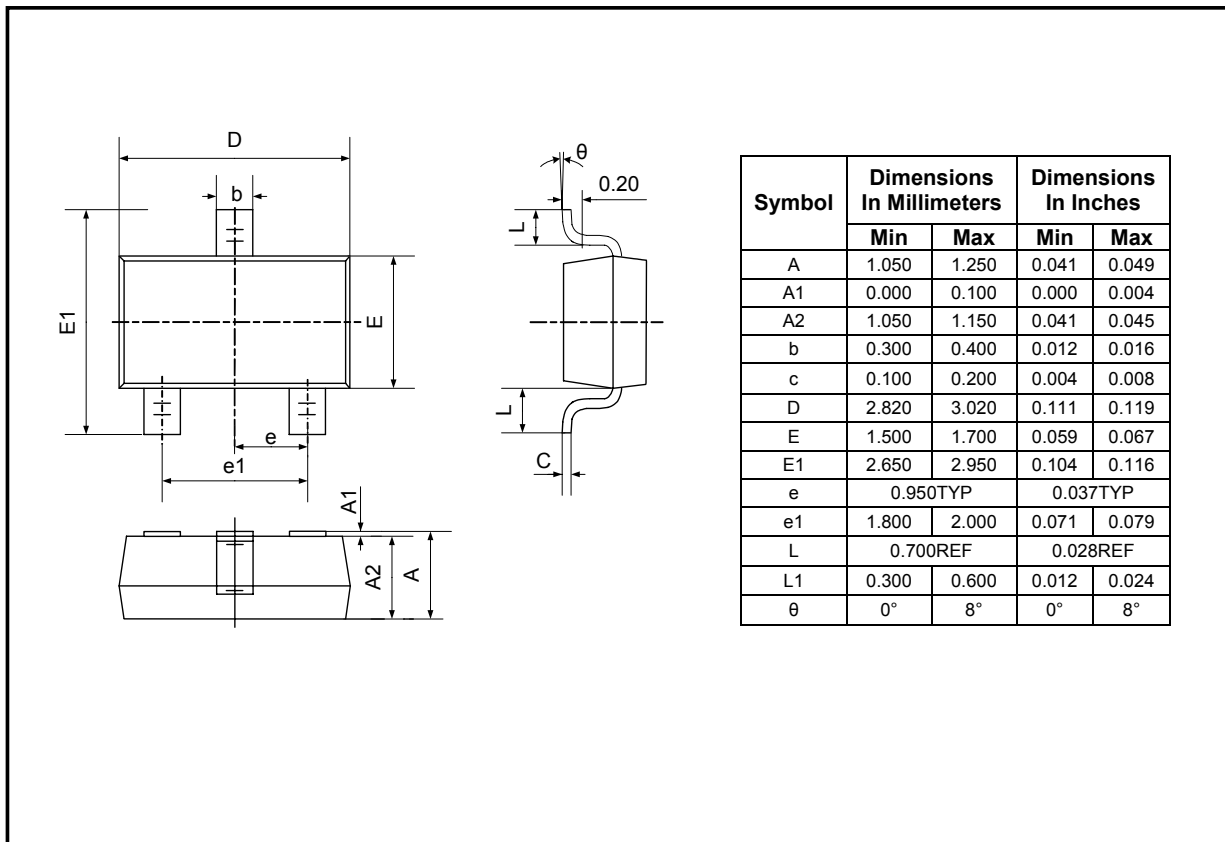

# PACKAGE OUTLINE DIMENSIONS

## SOT89-3

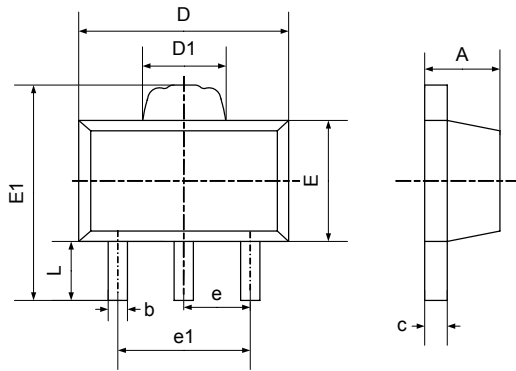

Symbol	Dimensions In Millimeters		Dimensions In Inches	
	Min	Max	Min	Max
A	1.400	1.600	0.055	0.063
b	0.320	0.520	0.013	0.020
b1	0.360	0.560	0.014	0.022
c	0.350	0.440	0.014	0.017
D	4.400	4.600	0.173	0.181
D1	1.400	1.800	0.055	0.071
E	2.300	2.600	0.091	0.102
E1	3.940	4.250	0.155	0.167
e	1.500TYP		0.060TYP	
e1	2.900	3.100	0.114	0.122
L	0.900	1.100	0.035	0.043



## REVISION HISTORY

Location	Page
<b>9/05— Data Sheet changed from preliminary to REV. A</b>	
<b>12/06— Data Sheet changed from REV. A to REV. B</b>	
Changed to ABSOLUTE MAXIMUM RATINGS .....	2
Added Application Notes .....	6

### Shengbang Microelectronics Co, Ltd

Unit 3, ChuangYe Plaza  
No.5, TaiHu Northern Street, YingBin Road Centralized Industrial Park  
Harbin Development Zone  
Harbin, HeiLongJiang 150078  
P.R. China  
Tel.: 86-451-84348461  
Fax: 86-451-84308461  
[www.sg-micro.com](http://www.sg-micro.com)