



TAI-SAW TECHNOLOGY CO., LTD.

No. 3, Industrial 2nd Rd., Ping-Chen Industrial District,
Tao-Yuan, 324, Taiwan, R.O.C.

TEL: 886-3-4690038 FAX: 886-3-4697532

E-mail: tstsales@mail.taisaw.com Web: www.taisaw.com

Approval Sheet for Product Specification

Issued Date:

Product Name: 480MHz IF SAW Filter (BW=54MHz)

TST Parts No.: TB0729A

Customer Parts No.: _____

Company: _____
Division: _____
Approved by : _____
Date: _____

Checked by: _____ Andy Yu *Andy*

Approval by: _____ Francis Chen *[Signature]*

Date: _____ 03/10/2009



TAI-SAW TECHNOLOGY CO., LTD.

No.3, Industrial 2nd Rd., Ping-Chen Industrial District, Taoyuan, Taiwan, R.O.C.

TEL: 886-3-4690038

FAX: 886-3-4697532

E-mail: tstsales3@mail.taisaw.com Web: www.taisaw.com

SAW Filter 480MHz (SMD 5.0×5.0 mm)

MODEL NO.: TB0729A

Rev. NO. 1.0

A. MAXIMUM RATING:

1. Operating Temperature: -30 °C ~ 70 °C
2. Storage Temperature: -40 °C ~ +85 °C

RoHS Compliant
Lead free
Lead-free soldering

B. Characteristics :

Ambient Temperature: 25 °C

Item	Unit	Min.	Type.	Max.
Center frequency, Fc	MHz	479.5	480	480.5
Max Insertion Loss	dB	-	11.5	15.0
1 dB Bandwidth	MHz	54	58.0	-
3 dB Bandwidth	MHz	56	62.0	-
Pass band Ripple Fc±27MHz	dB	-	0.6	1.2
Group delay 453~507MHz	ns		10	40
Relative Attenuation: (Reference level from Max IL)				
320MHz to 440MHz	dB	35	44	-
520MHz to 640MHz	dB	35	43	-

Matching:

1. The input of the filter will be matched to 50 ohm
2. The output of the filter will be matched to 50 ohm

C.FREQUENCY CHARACTERISTICS:

(1) S21 Response:(span 320MHz)

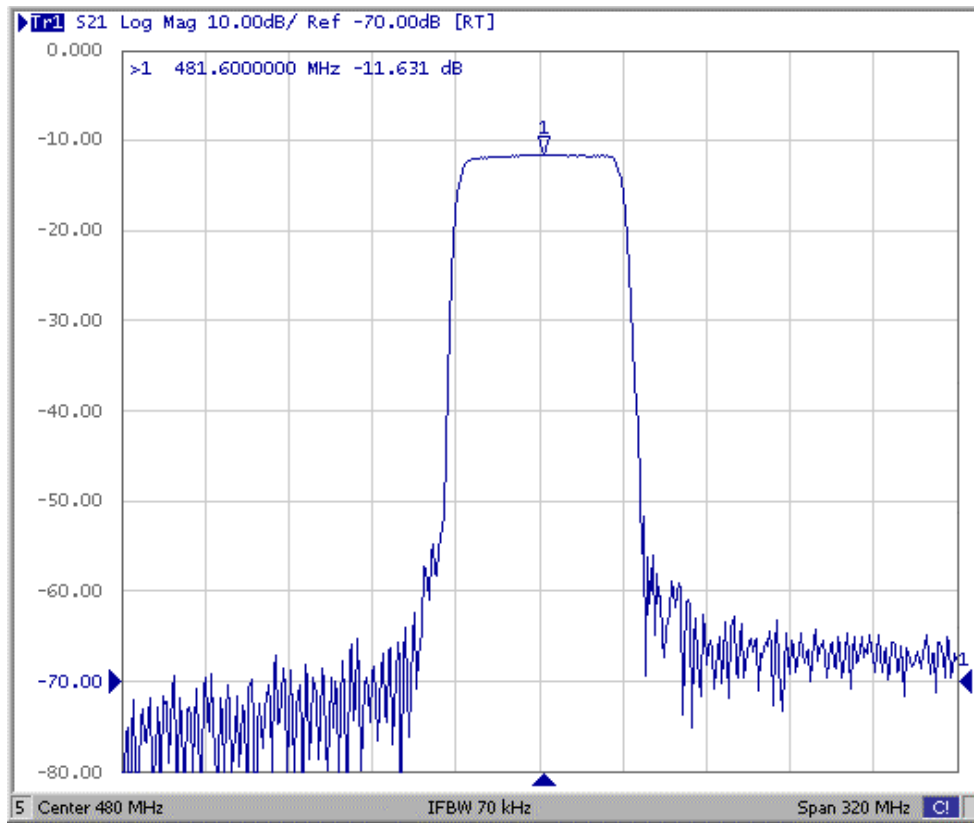

(2) Passband of Response: (span: 80MHz)

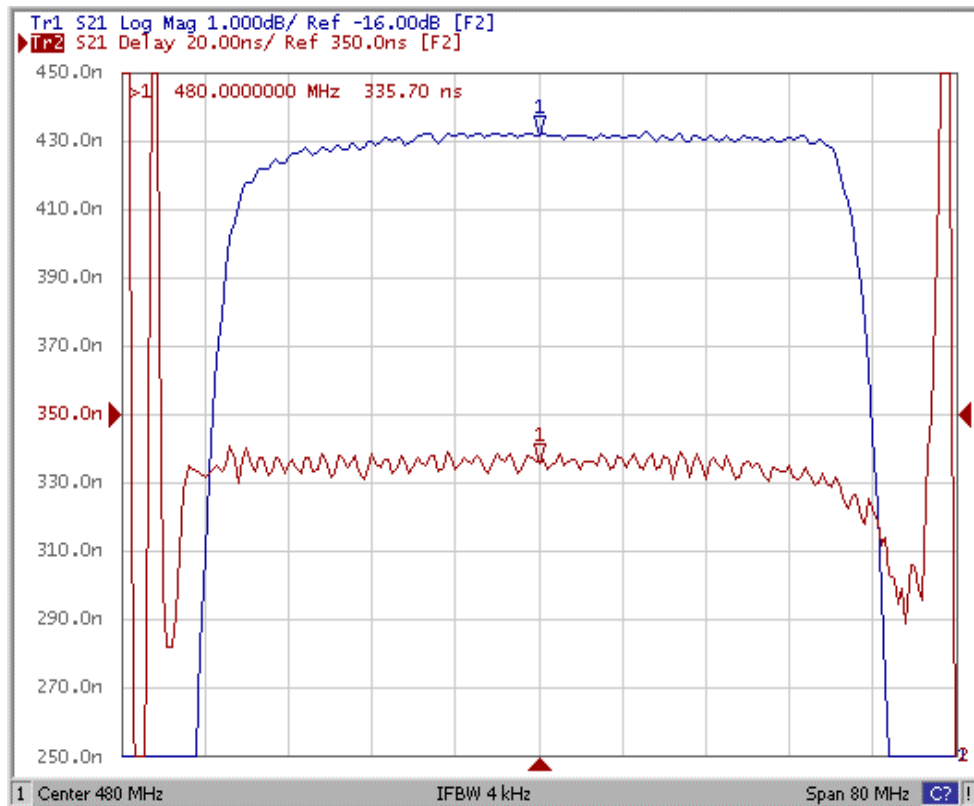

(3) S11 Smith Chart: (span 300MHz)

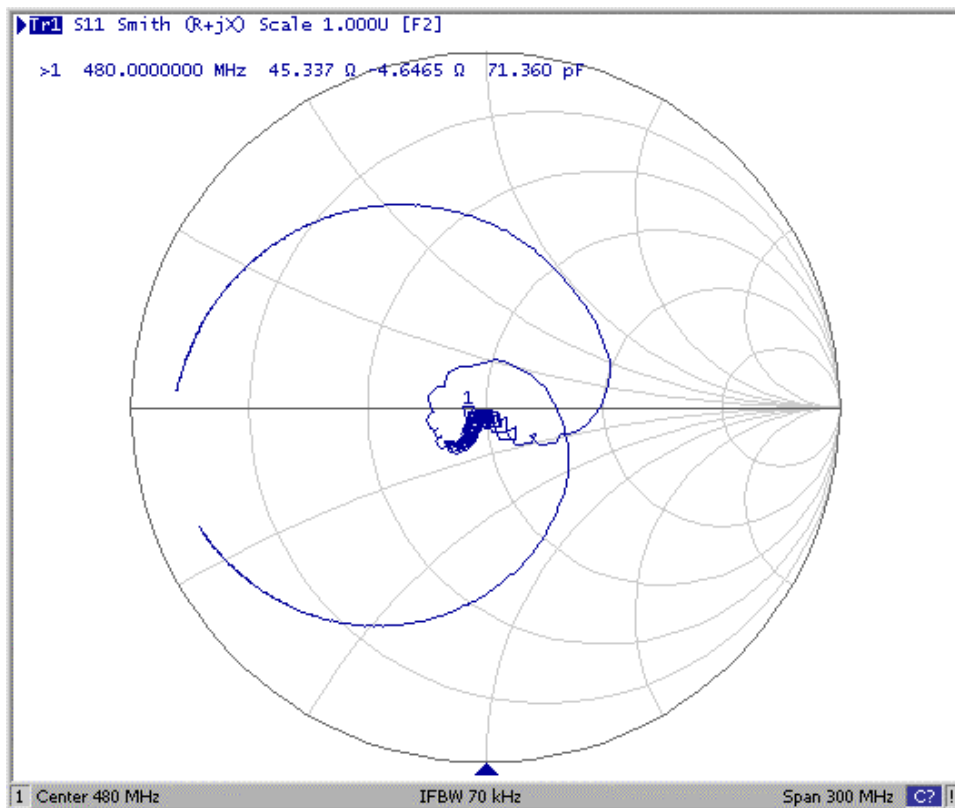

(4) S22 Smith Chart: (span 300MHz)

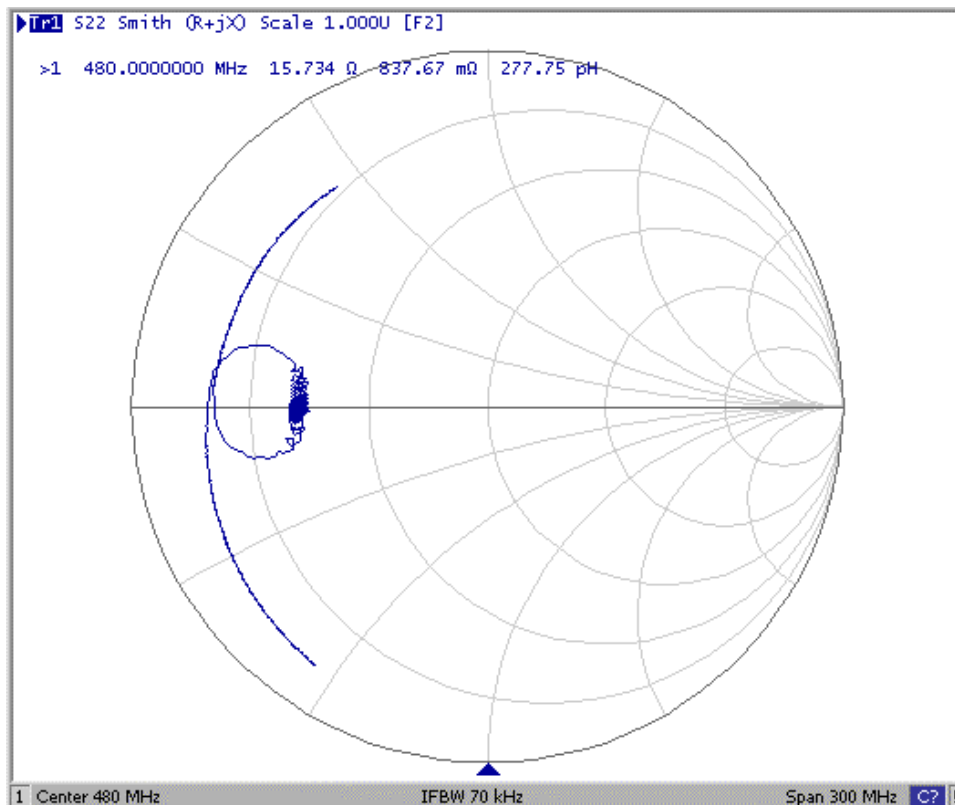

D. TEST CIRCUIT:

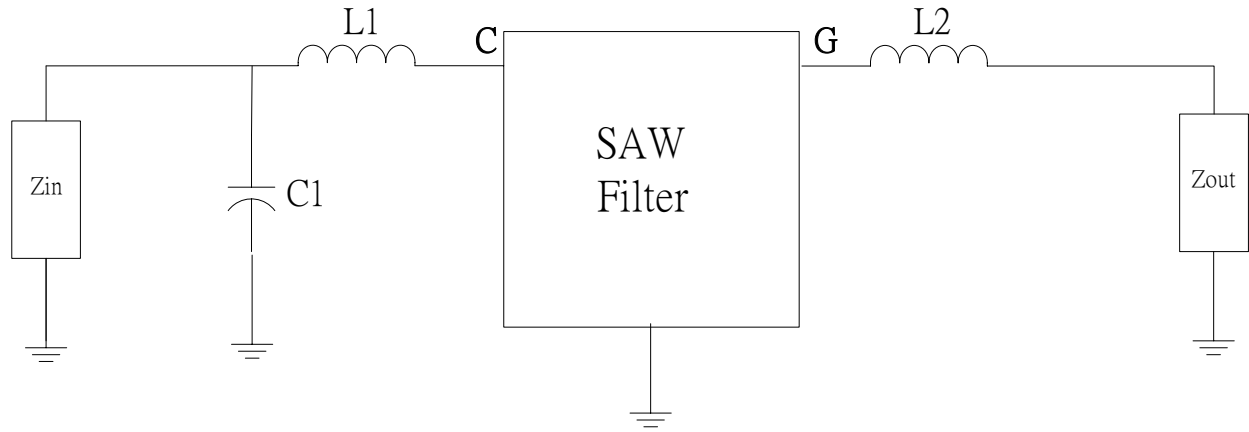

Zin and Zout are 50Ω
L1=15nH, C1=10pF, L2=2.7nH

E. OUTLINE DRAWING:

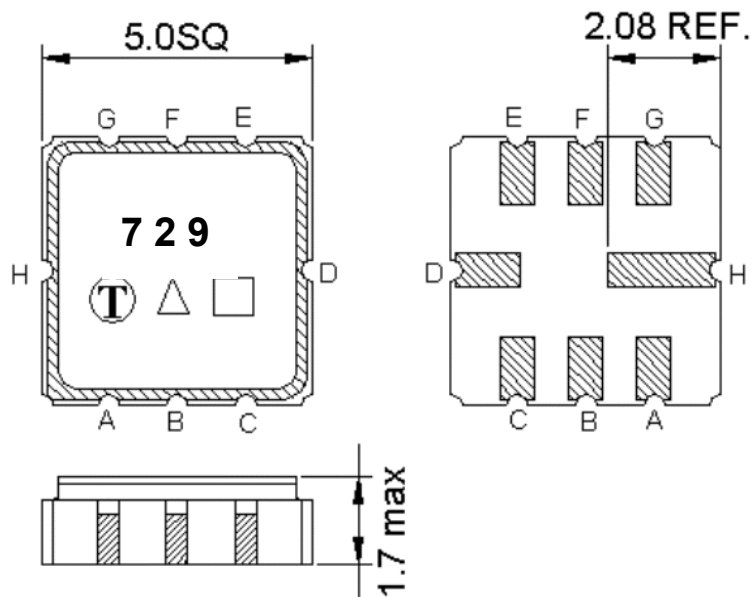

Pin C: RF input

Pin G: RF output

Pin H,D: Case Ground

Pin A, B, E, F: Ground

□ : Week Code (Follow the table from planner each year)

Unit : mm

△ : Product / Year Code

Year	2005 2009	2006 2010	2007 2011	2008 2012
Product Code	B	b	<u>B</u>	<u>b</u>

F.PACKING:

1.REEL DIMENSION

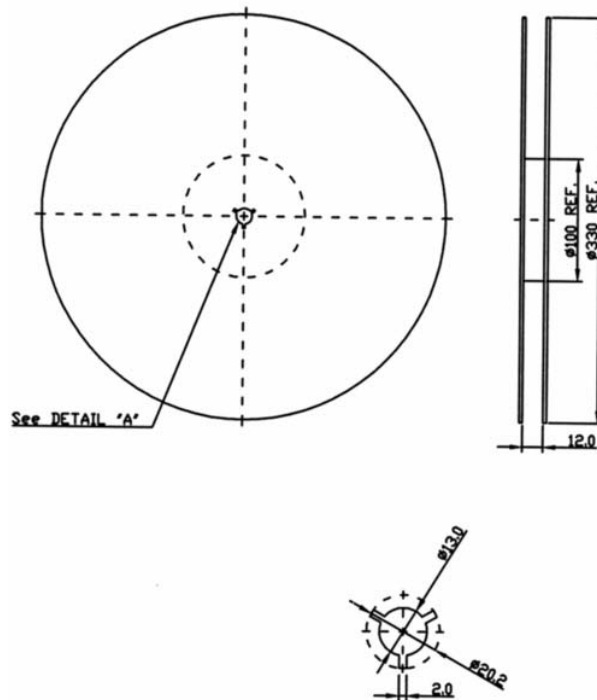

2.TAPE DIMENSION

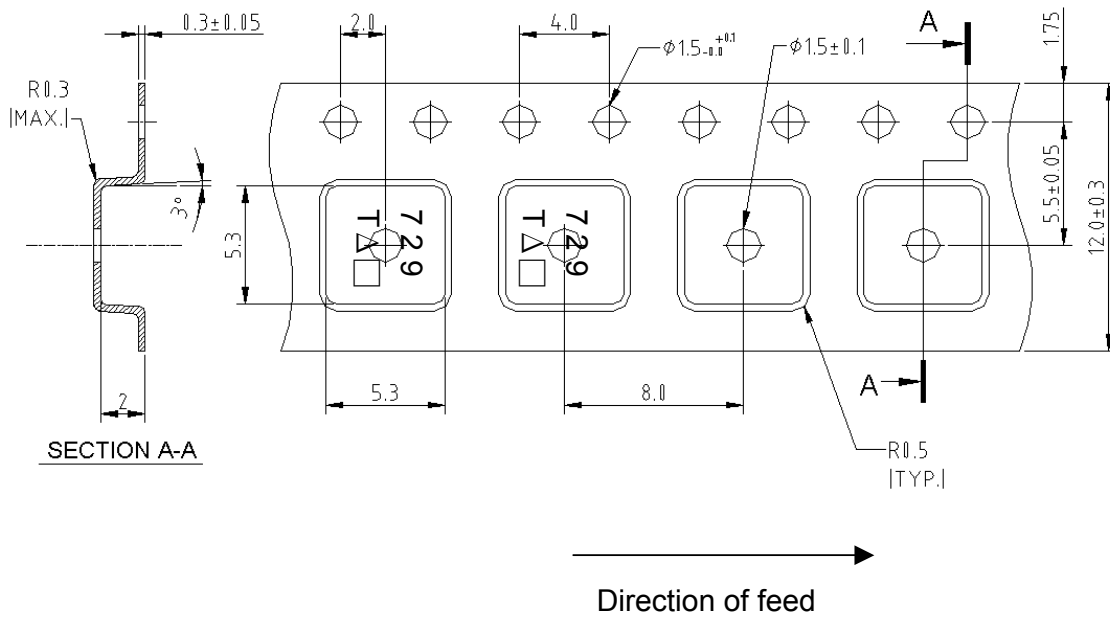

G. Recommended Reflow Profile:

