

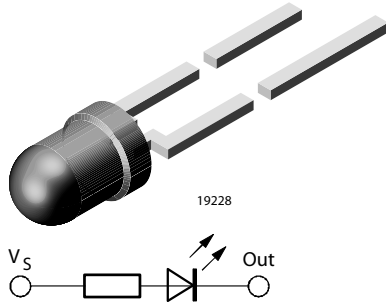

Resistor LED for 12 V Supply Voltage



DESCRIPTION

These devices are developed for the automotive industry and other industries which use 12 V sources. The TLR.440.CU series contains an integrated resistor for current limiting in series with the LED chip. This allows the lamp to be driven from a 12 V source without an external current limiter.

Available colors are red, soft orange, yellow, green and pure green. The luminous intensity of such an LED is measured at constant voltage of 12 V.

These tinted diffused lamps provide a wide off-axis viewing angle.

These LEDs are intended for space critical applications such as automobile instrument panels, switches and others which are driven from a 12 V source.

FEATURES

- With current limiting resistor for 12 V
- Cost effective: save space and resistor cost
- Standard \varnothing 3 mm (T-1) package
- Wide viewing angle
- Choice of five bright colors
- Luminous intensity categorized
- Yellow and green color categorized
- Luminous intensity and color are measured at 12 V
- Compliant to RoHS directive 2002/95/EC and in accordance to WEEE 2002/96/EC



RoHS COMPLIANT

APPLICATIONS

- Status light in cars and other applications with a 12 V source
- Off/on indicator in cars and other applications with a 12 V source
- Background illumination for switches
- Off/on indicator in switches

PRODUCT GROUP AND PACKAGE DATA

- Product group: LED
- Package: 3 mm
- Product series: resistor
- Angle of half intensity: $\pm 30^\circ$

PARTS TABLE		
PART	COLOR, LUMINOUS INTENSITY	TECHNOLOGY
TLRP4400CU	Pure green, $I_V > 0.63$ mcd	GaP on GaP
TLRP4401CU	Pure green, $I_V > 1.6$ mcd	GaP on GaP
TLRP4406CU	Pure green, $I_V = (1.6 \text{ to } 5)$ mcd	GaP on GaP
TLRH4400CU	Red, $I_V > 1.6$ mcd	GaAsP on GaP
TLRO4400CU	Soft orange, $I_V > 4$ mcd	GaAsP on GaP
TLRY4400CU	Yellow, $I_V > 1.6$ mcd	GaAsP on GaP
TLRG4400CU	Green, $I_V > 1.6$ mcd	GaP on GaP

ABSOLUTE MAXIMUM RATINGS ¹⁾ TLRH4400CU, TLR04400CU, TRLRY4400CU, TLRG4400CU, TLRP4400CU

PARAMETER	TEST CONDITION	SYMBOL	VALUE	UNIT
Reverse voltage		V_R	6	V
Forward voltage	$T_{amb} \leq 65\text{ }^\circ\text{C}$	V_F	16	V
Power dissipation		P_V	240	mW
Junction temperature		T_j	100	$^\circ\text{C}$
Operating temperature range		T_{amb}	- 40 to + 100	$^\circ\text{C}$
Storage temperature range		T_{stg}	- 55 to + 100	$^\circ\text{C}$
Soldering temperature	$t \leq 5\text{ s}$, 2 mm from body	T_{sd}	260	$^\circ\text{C}$
Thermal resistance junction/ambient		R_{thJA}	150	K/W

Note:

¹⁾ $T_{amb} = 25\text{ }^\circ\text{C}$ unless otherwise specified

OPTICAL AND ELECTRICAL CHARACTERISTICS ¹⁾ TLRH4400CU, RED

PARAMETER	TEST CONDITION	SYMBOL	MIN.	TYP.	MAX.	UNIT
Luminous intensity ²⁾	$V_S = 12\text{ V}$	I_V	1.6	10		mcd
Dominant wavelength	$V_S = 12\text{ V}$	λ_d	612		625	nm
Peak wavelength	$V_S = 12\text{ V}$	λ_p		635		nm
Angle of half intensity	$V_S = 12\text{ V}$	ϕ		± 30		deg
Forward current	$V_S = 12\text{ V}$	I_F		10	12	mA
Breakdown voltage	$I_R = 10\text{ }\mu\text{A}$	V_{BR}	6	20		V
Junction capacitance	$V_R = 0$, $f = 1\text{ MHz}$	C_j		50		pF

Note:

¹⁾ $T_{amb} = 25\text{ }^\circ\text{C}$ unless otherwise specified

²⁾ In one packing unit $I_{Vmin}/I_{Vmax} \leq 0.5$

OPTICAL AND ELECTRICAL CHARACTERISTICS ¹⁾ TLRO4400CU, SOFT ORANGE

PARAMETER	TEST CONDITION	SYMBOL	MIN.	TYP.	MAX.	UNIT
Luminous intensity ²⁾	$V_S = 12\text{ V}$	I_V	4	10		mcd
Dominant wavelength	$V_S = 12\text{ V}$	λ_d	598		611	nm
Peak wavelength	$V_S = 12\text{ V}$	λ_p		605		nm
Angle of half intensity	$V_S = 12\text{ V}$	ϕ		± 30		deg
Forward current	$V_S = 12\text{ V}$	I_F		10	12	mA
Breakdown voltage	$I_R = 10\text{ }\mu\text{A}$	V_{BR}	6	20		V
Junction capacitance	$V_R = 0$, $f = 1\text{ MHz}$	C_j		50		pF

Note:

¹⁾ $T_{amb} = 25\text{ }^\circ\text{C}$ unless otherwise specified

²⁾ In one packing unit $I_{Vmin}/I_{Vmax} \leq 0.5$



OPTICAL AND ELECTRICAL CHARACTERISTICS ¹⁾, TLR4400CU, YELLOW						
PARAMETER	TEST CONDITION	SYMBOL	MIN.	TYP.	MAX.	UNIT
Luminous intensity ²⁾	$V_S = 12\text{ V}$	I_V	1.6	10		mcd
Dominant wavelength	$V_S = 12\text{ V}$	λ_d	581		594	nm
Peak wavelength	$V_S = 12\text{ V}$	λ_p		585		nm
Angle of half intensity	$V_S = 12\text{ V}$	φ		± 30		deg
Forward current	$V_S = 12\text{ V}$	I_F		10	12	mA
Breakdown voltage	$I_R = 10\ \mu\text{A}$	V_{BR}	6	20		V
Junction capacitance	$V_R = 0, f = 1\text{ MHz}$	C_j		50		pF

Note:

¹⁾ $T_{amb} = 25\text{ °C}$ unless otherwise specified

²⁾ In one packing unit $I_{Vmin.}/I_{Vmax.} \leq 0.5$

OPTICAL AND ELECTRICAL CHARACTERISTICS ¹⁾, TLRG4400CU, GREEN						
PARAMETER	TEST CONDITION	SYMBOL	MIN.	TYP.	MAX.	UNIT
Luminous intensity ²⁾	$V_S = 12\text{ V}$	I_V	1.6	10		mcd
Dominant wavelength	$V_S = 12\text{ V}$	λ_d	562		575	nm
Peak wavelength	$V_S = 12\text{ V}$	λ_p		565		nm
Angle of half intensity	$V_S = 12\text{ V}$	φ		± 30		deg
Forward current	$V_S = 12\text{ V}$	I_F		10	12	mA
Breakdown voltage	$I_R = 10\ \mu\text{A}$	V_{BR}	6	20		V
Junction capacitance	$V_R = 0, f = 1\text{ MHz}$	C_j		50		pF

Note:

¹⁾ $T_{amb} = 25\text{ °C}$ unless otherwise specified

²⁾ In one packing unit $I_{Vmin.}/I_{Vmax.} \leq 0.5$

OPTICAL AND ELECTRICAL CHARACTERISTICS ¹⁾, TLRP440.CU, PURE GREEN							
PARAMETER	TEST CONDITION	PART	SYMBOL	MIN.	TYP.	MAX.	UNIT
Luminous intensity ²⁾	$V_S = 12\text{ V}$	TLRP4400CU	I_V	0.63	3		mcd
		TLRP4401CU	I_V	1.6	4		mcd
		TLRP4406CU	I_V	1.6		5	mcd
Dominant wavelength	$V_S = 12\text{ V}$		λ_d	555		565	nm
Peak wavelength	$V_S = 12\text{ V}$		λ_p		555		nm
Angle of half intensity	$V_S = 12\text{ V}$		φ		± 30		deg
Forward current	$V_S = 12\text{ V}$		I_F		10	12	mA
Breakdown voltage	$I_R = 10\ \mu\text{A}$		V_{BR}	6	20		V
Junction capacitance	$V_R = 0, f = 1\text{ MHz}$		C_j		50		pF

Note:

¹⁾ $T_{amb} = 25\text{ °C}$ unless otherwise specified

²⁾ In one packing unit $I_{Vmin.}/I_{Vmax.} \leq 0.5$

TYPICAL CHARACTERISTICS

$T_{amb} = 25\text{ }^{\circ}\text{C}$ unless otherwise specified

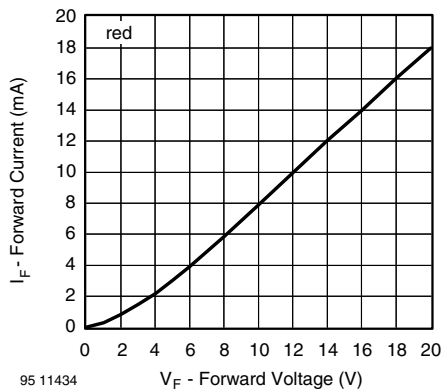

Figure 1. Forward Current vs. Forward Voltage

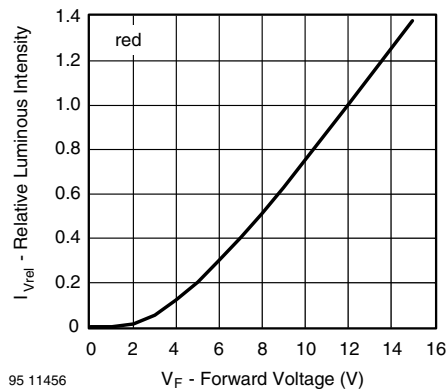

Figure 4. Relative Luminous Intensity vs. Forward Voltage

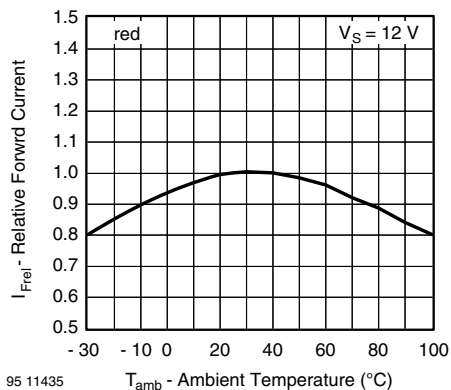

Figure 2. Relative Forward Current vs. Ambient Temperature

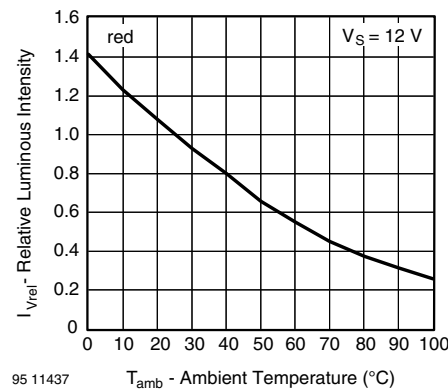

Figure 5. Rel. Luminous Intensity vs. Ambient Temperature

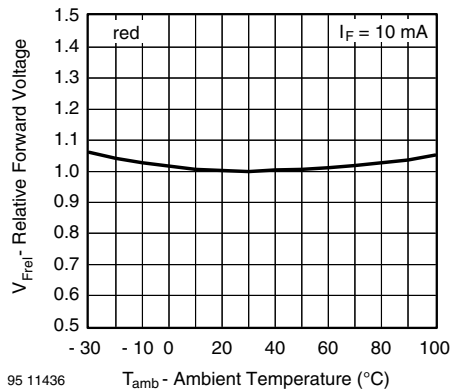

Figure 3. Relative Forward Voltage vs. Ambient Temperature

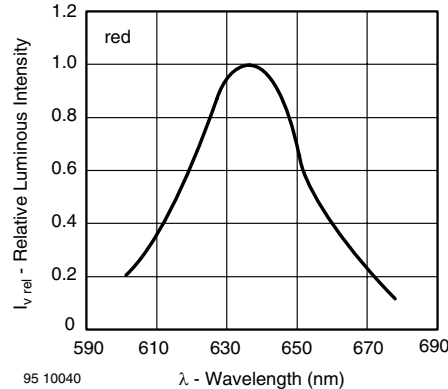
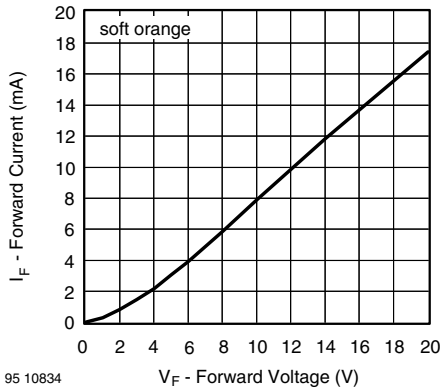
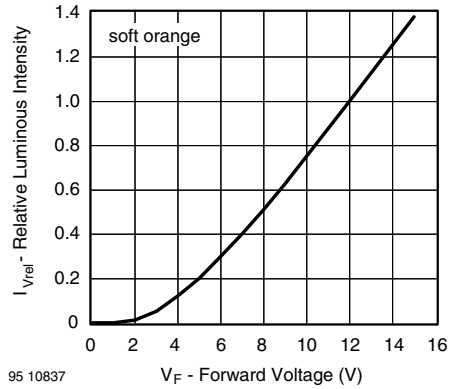

Figure 6. Relative Intensity vs. Wavelength



95 10834

Figure 7. Forward Current vs. Forward Voltage



95 10837

Figure 10. Relative Luminous Intensity vs. Forward Voltage

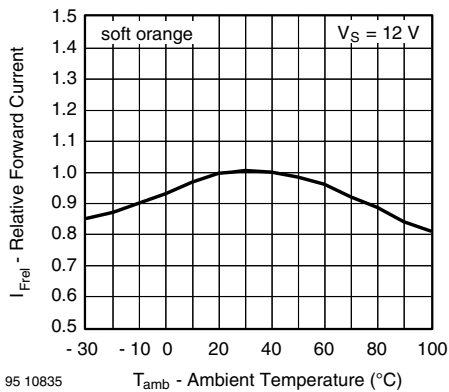

95 10835

Figure 8. Relative Forward Current vs. Ambient Temperature

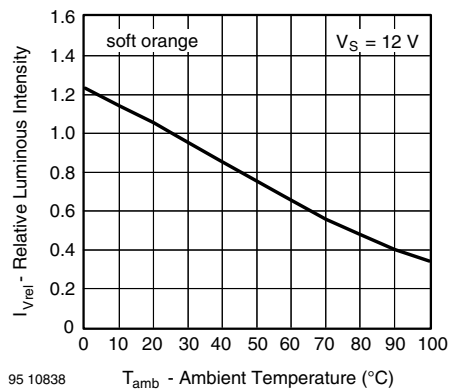

95 10838

Figure 11. Rel. Luminous Intensity vs. Ambient Temperature

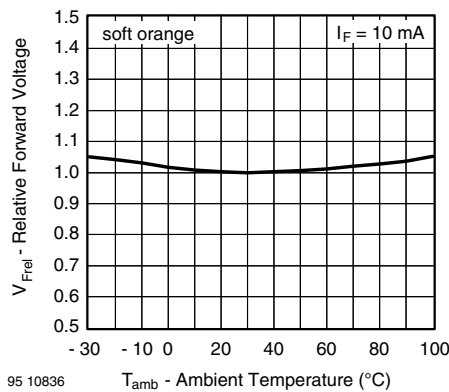

95 10836

Figure 9. Relative Forward Voltage vs. Ambient Temperature

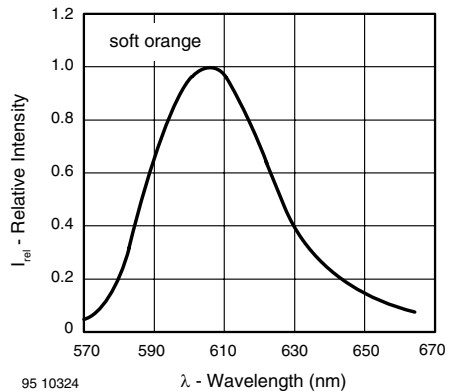

95 10324

Figure 12. Relative Intensity vs. Wavelength

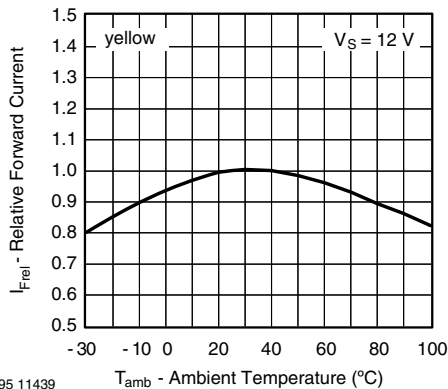

Figure 13. Relative Forward Current vs. Ambient Temperature

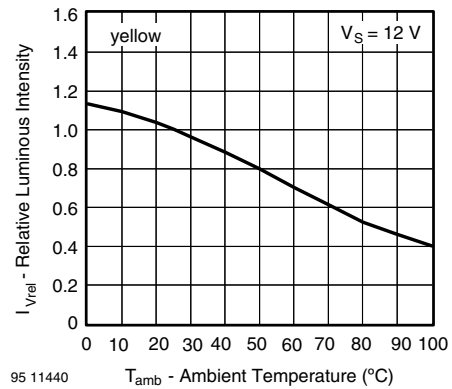

Figure 16. Rel. Luminous Intensity vs. Ambient Temperature

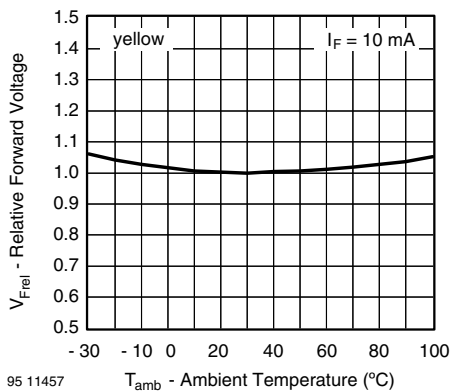

Figure 14. Relative Forward Voltage vs. Ambient Temperature

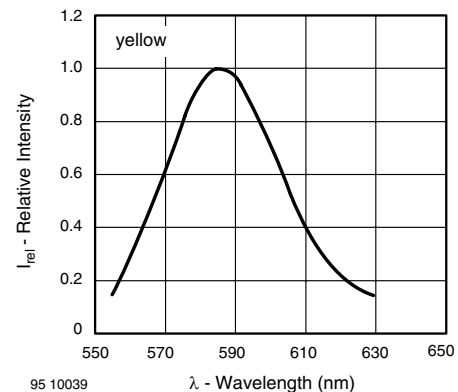

Figure 17. Relative Intensity vs. Wavelength

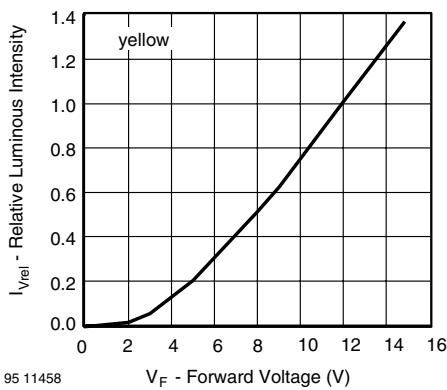

Figure 15. Relative Luminous Intensity vs. Forward Voltage

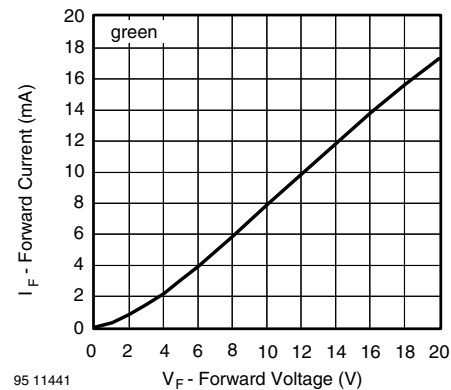

Figure 18. Forward Current vs. Forward Voltage

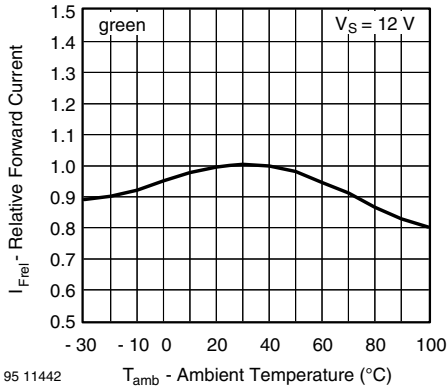

Figure 19. Relative Forward Current vs. Ambient Temperature

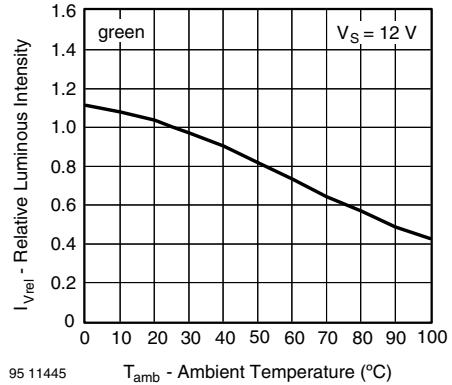

Figure 22. Rel. Luminous Intensity vs. Ambient Temperature

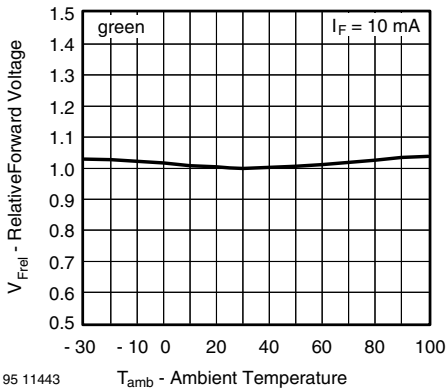

Figure 20. Relative Forward Voltage vs. Ambient Temperature

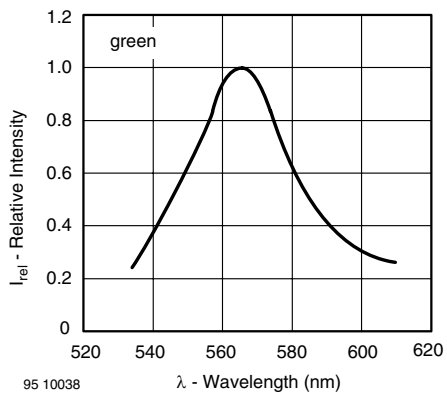

Figure 23. Relative Intensity vs. Wavelength

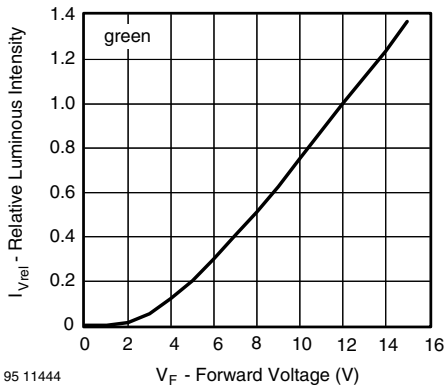

Figure 21. Relative Luminous Intensity vs. Forward Voltage

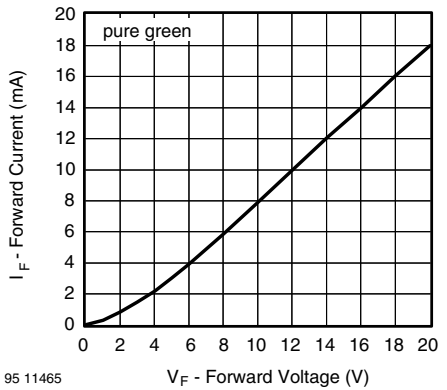

Figure 24. Forward Current vs. Forward Voltage

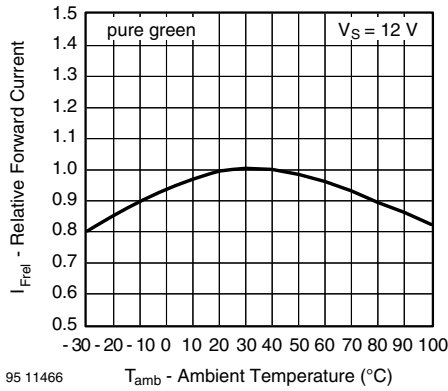

Figure 25. Relative Forward Current vs. Ambient Temperature

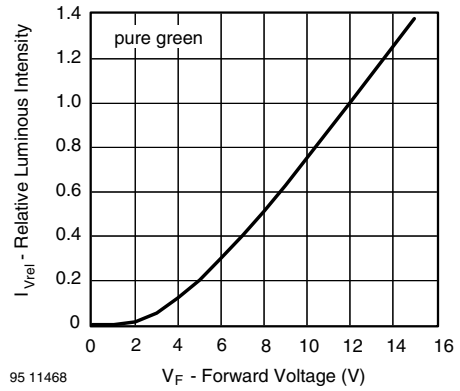

Figure 27. Relative Luminous Intensity vs. Forward Voltage

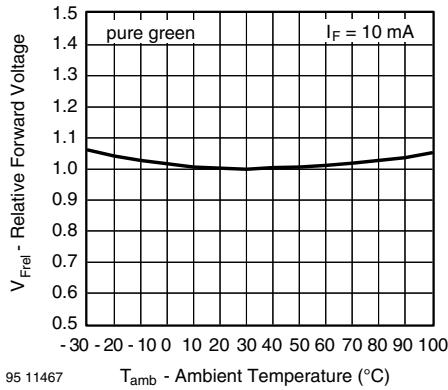

Figure 26. Relative Forward Voltage vs. Ambient Temperature

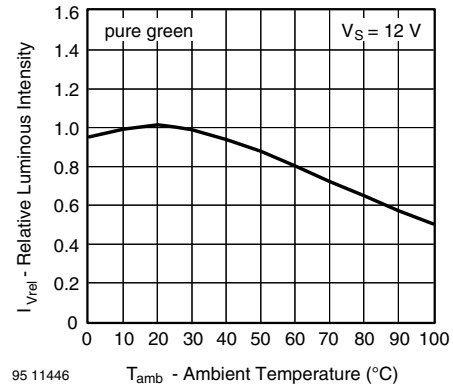
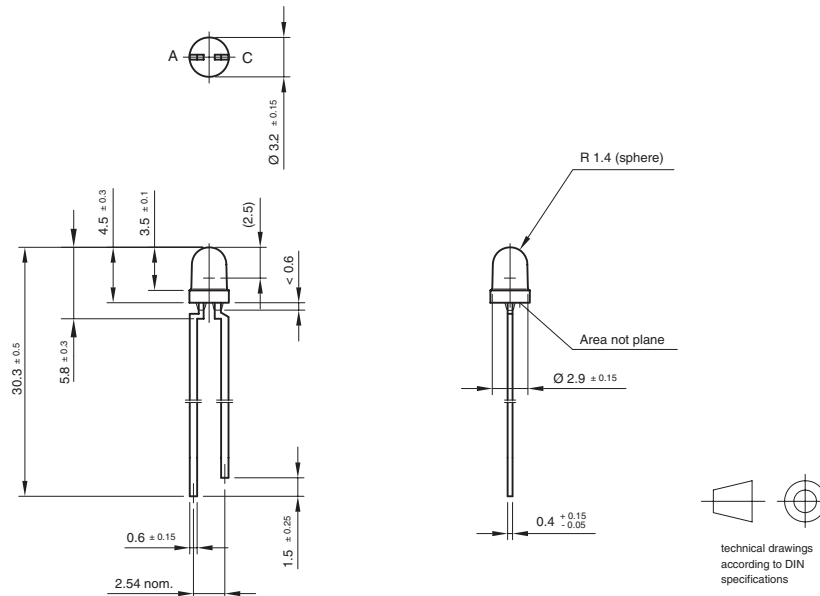

Figure 28. Rel. Luminous Intensity vs. Ambient Temperature

PACKAGE DIMENSIONS in millimeters



Drawing-No.: 6.544-5255.01-4
Issue: 7; 25.09.08
95 10913



Disclaimer

All product specifications and data are subject to change without notice.

Vishay Intertechnology, Inc., its affiliates, agents, and employees, and all persons acting on its or their behalf (collectively, "Vishay"), disclaim any and all liability for any errors, inaccuracies or incompleteness contained herein or in any other disclosure relating to any product.

Vishay disclaims any and all liability arising out of the use or application of any product described herein or of any information provided herein to the maximum extent permitted by law. The product specifications do not expand or otherwise modify Vishay's terms and conditions of purchase, including but not limited to the warranty expressed therein, which apply to these products.

No license, express or implied, by estoppel or otherwise, to any intellectual property rights is granted by this document or by any conduct of Vishay.

The products shown herein are not designed for use in medical, life-saving, or life-sustaining applications unless otherwise expressly indicated. Customers using or selling Vishay products not expressly indicated for use in such applications do so entirely at their own risk and agree to fully indemnify Vishay for any damages arising or resulting from such use or sale. Please contact authorized Vishay personnel to obtain written terms and conditions regarding products designed for such applications.

Product names and markings noted herein may be trademarks of their respective owners.