

### TLRE1005B

#### Features

3.2 (L) x 2.4 (W) x 2.4 (H) mm  
 2 mm lens top type  
 InGaAlP LED  
 Reflow soldering is possible  
 Standard embossed taping 4 mm pitch : T03 (1000 pcs/reel)

#### Applications

High-output backlighting source  
 Battery-powered equipment  
 Message boards  
 Portable devices  
 Computer peripherals

#### Maximum Ratings (Ta=25°C)

Characteristic	Symbol	Max.	Unit
Forward Current	I <sub>F</sub>	25	mA
Reverse Voltage	V <sub>R</sub>	4.00	V
Power Dissipation	P <sub>D</sub>	60.00	mW
Operating Temperature	T <sub>opr</sub>	-40 ~ 85	°C
Storage Temperature	T <sub>stg</sub>	-40 ~ 100	°C
Soldering Temperature	T <sub>sol</sub>	260	°C
Soldering Time	-	for 3 sec. max	-

#### Opto-Electrical Characteristics (Ta=25°C)

Characteristic	Symbol	Test Condition	Min	Typ	Max	Unit
Forward Voltage	V <sub>F</sub>	I <sub>F</sub> =20mA	-	1.90	2.40	V
Reverse Current	I <sub>R</sub>	V <sub>R</sub> =4V	-	-	50	μA
Luminous Intensity	I <sub>v</sub>	I <sub>F</sub> =20mA	153.00	450.00	-	mcd
Viewing Angle	2θ <sup>1/2</sup>	-	-	45°	-	deg.
Peak Wavelength	λ <sub>p</sub>	I <sub>F</sub> =20mA	-	644	-	nm
Dominant Wavelength	λ <sub>d</sub>	I <sub>F</sub> =20mA	-	630	-	nm
Spectral Line Half Width	Δλ	I <sub>F</sub> =20mA	-	18	-	nm

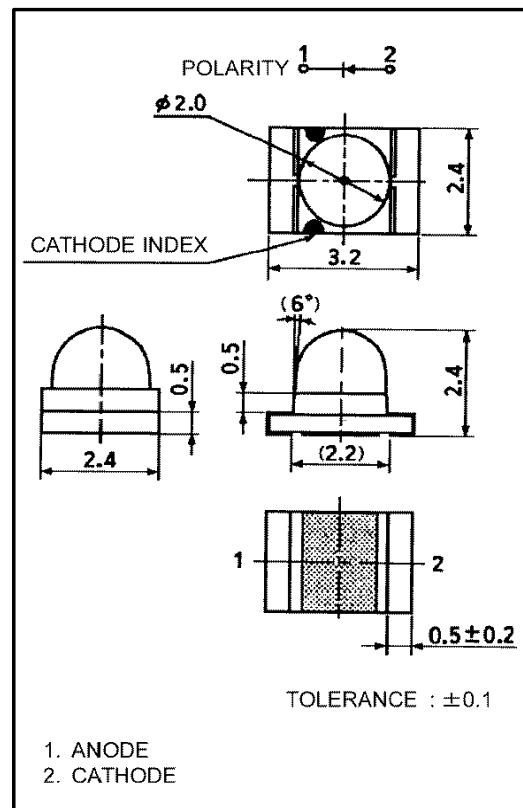

**Company Headquarters**  
 3 Northway Lane North  
 Latham, New York 12110  
 Toll Free: 800.984.5337  
 Fax: 518.785.4725



Web: [www.marktechopt.com](http://www.marktechopt.com) | Email: [info@marktechopt.com](mailto:info@marktechopt.com)

**California Sales Office:**  
 950 South Coast Drive, Suite 265  
 Costa Mesa, California 92626  
 Toll Free: 800.984.5337  
 Fax: 714.850.9314

### TLRE1005B Graphs

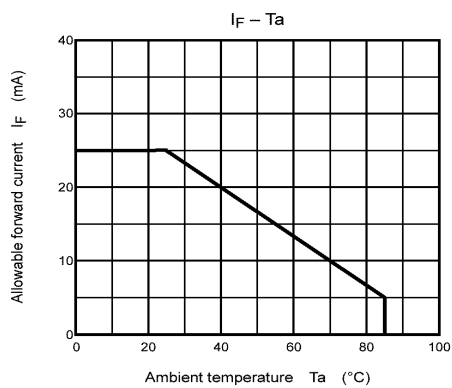
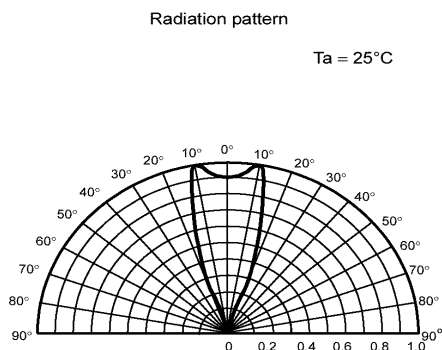
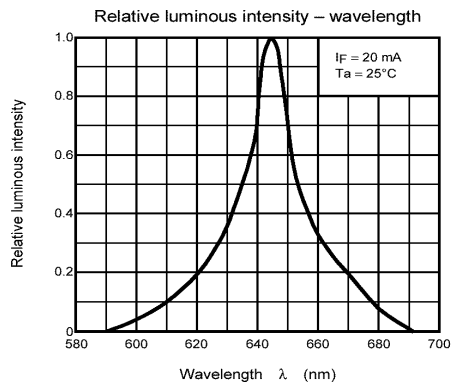
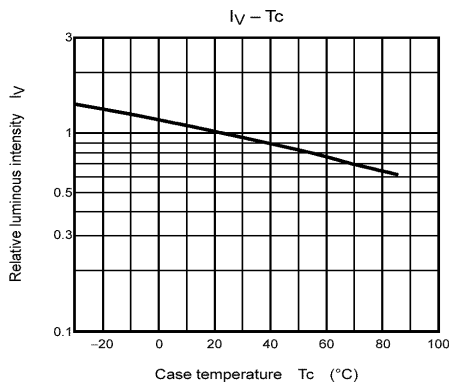
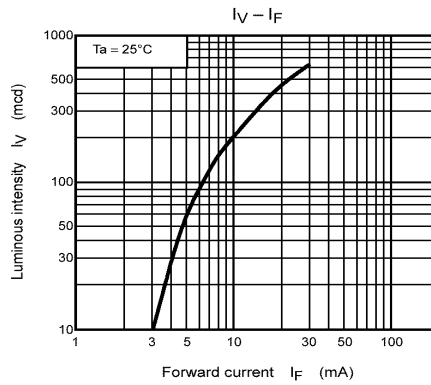
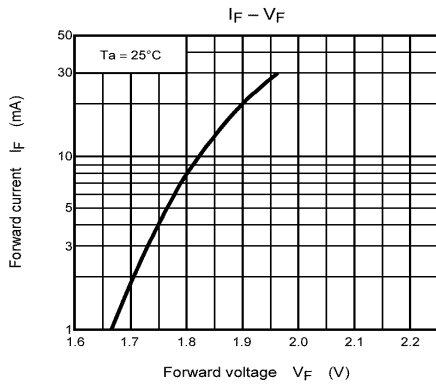

**Company Headquarters**  
 3 Northway Lane North  
 Latham, New York 12110  
 Toll Free: 800.984.5337  
 Fax: 518.785.4725



Web: [www.marktechopt.com](http://www.marktechopt.com) | Email: [info@marktechopt.com](mailto:info@marktechopt.com)

**California Sales Office:**  
 950 South Coast Drive, Suite 265  
 Costa Mesa, California 92626  
 Toll Free: 800.984.5337  
 Fax: 714.850.9314

### NOTICE:

- TOSHIBA is continually working to improve the quality and reliability of its products. Nevertheless, semiconductor devices in general can malfunction or fail due to their inherent electrical sensitivity and vulnerability to physical stress. It is the responsibility of the buyer, when utilizing TOSHIBA products, to comply with the standards of safety in making a safe design for the entire system, and to avoid situations in which a malfunction or failure of such TOSHIBA products could cause loss of human life, bodily injury or damage to property.
- In developing your designs, please ensure that TOSHIBA products are used within specified operating ranges as set forth in the most recent TOSHIBA products specifications. Also, please keep in mind the precautions and conditions set forth in the "Handling Guide for Semiconductor Devices," or "TOSHIBA Semiconductor Reliability Handbook" etc..
- The TOSHIBA products listed in this document are intended for usage in general electronics applications (computer, personal equipment, office equipment, measuring equipment, industrial robotics, domestic appliances, etc.). These TOSHIBA products are neither intended nor warranted for usage in equipment that requires extraordinarily high quality and/or reliability or a malfunction or failure of which may cause loss of human life or bodily injury ("Unintended Usage"). Unintended Usage include atomic energy control instruments, airplane or spaceship instruments, transportation instruments, traffic signal instruments, combustion control instruments, medical instruments, all types of safety devices, etc.. Unintended Usage of TOSHIBA products listed in this document shall be made at the customer's own risk.
- Gallium arsenide (GaAs) is a substance used in the products described in this document. GaAs dust and fumes are toxic. Do not break, cut or pulverize the product, or use chemicals to dissolve them. When disposing of the products, follow the appropriate regulations. Do not dispose of the products with other industrial waste or with domestic garbage.
- The information contained herein is presented only as a guide for the applications of our products. No responsibility is assumed by TOSHIBA CORPORATION for any infringements of intellectual property or other rights of the third parties which may result from its use. No license is granted by implication or otherwise under any intellectual property or other rights of TOSHIBA CORPORATION or others.
- The information contained herein is subject to change without notice.

**Company Headquarters**  
3 Northway Lane North  
Latham, New York 12110  
Toll Free: 800.984.5337  
Fax: 518.785.4725



Web: [www.marktechopto.com](http://www.marktechopto.com) | Email: [info@marktechopto.com](mailto:info@marktechopto.com)

**California Sales Office:**  
950 South Coast Drive, Suite 265  
Costa Mesa, California 92626  
Toll Free: 800.984.5337  
Fax: 714.850.9314