

**NT1GC72B89A0NL / NT2GC72B8PA0NL
 NT4GC72B4NA1NL / NT4GC72B8NA1NL / NT8GTC72B4NA1NL
 1GB: 128M x 72 / 2GB: 256M x 72 / 4GB: 512M x 72 / 8GB: 1G x 72
 PC3-8500 / PC3-10600
 Registered DDR3 SDRAM DIMM**



Based on DDR3-1066/1333 128Mx8 (1GB/2GB/4GB) / 256Mx4 (4GB) / 512Mx4 (DDP) (8GB) SDRAM A-Die

Features

•Performance:

Speed Sort	PC3-8500	PC3-10600	Unit
	-BE	-CG	
DIMM CAS Latency	7	9	
fck – Clock Frequency	533	667	MHz
tck – Clock Cycle	1.875	1.5	ns
fDQ – DQ Burst Frequency	1066	1333	Mbps

- 240-Pin Registered Dual In-Line Memory Module (RDIMM)
- 1GB/2GB/4GB: 128Mx72/256Mx72/512Mx72 DDR3 Registered DIMM based on 128Mx8 DDR3 SDRAM A-Die devices.
- 4GB: 512Mx72 DDR3 Registered DIMM based on 256Mx4 DDR3 SDRAM A-Die devices.
- 8GB: 1Gx72 DDR3 Registered DIMM based on 512Mx4 (DDP) DDR3 SDRAM A-Die devices.
- Intended for 533MHz/667MHz applications
- Inputs and outputs are SSTL-15 compatible
- $V_{DD} = V_{DDQ} = 1.5V \pm 0.075V$
- SDRAMs have 8 internal banks for concurrent operation
- Differential clock inputs
- Data is read or written on both clock edges
- DRAM DLL aligns DQ and DQS transitions with clock transitions.
- Address and control signals are fully synchronous to positive clock edge
- Nominal and Dynamic On-Die Termination support
- Programmable Operation:

- DIMM \overline{CAS} Latency: 6,7,8,9
- Burst Type: Sequential or Interleave
- Burst Length: BC4, BL8
- Operation: Burst Read and Write
- Two different termination values (Rtt_Nom & Rtt_WR)
- 14/10/1 (row/column/rank) Addressing for 1GB
- 14/10/2 (row/column/rank) Addressing for 2GB
- 14/10/4 (row/column/rank) Addressing for 4GB (128Mx8 Device)
- 14/11/2 (row/column/rank) Addressing for 4GB (256Mx4 Device)
- 14/11/4 (row/column/rank) Addressing for 8GB
- Extended operating temperature range
- Auto Self-Refresh option
- Serial Presence Detect
- Gold contacts
- SDRAMs are in 78-ball BGA Package
- RoHS compliance
- Halogen free product

Description

NT1GC72B89A0NL, NT2GC72B8PA0NL, NT4GC72B8NA1NL, NT4GC72B4NA1NL and NT8GTC72B4NA1NL are 240-Pin Double Data Rate 3 (DDR3) Synchronous DRAM Registered Dual In-Line Memory Module, organized as one rank of 128Mx72 (1GB), two ranks of 256Mx72 (2GB), two or four ranks of 512Mx72 (4GB) and four ranks of 1Gx72 (8GB) high-speed memory array. Modules use nine 128Mx8 (1GB) 78-ball BGA packaged devices, eighteen 128Mx8 (2GB) 78-ball BGA packaged devices, thirty-six 256Mx4 (4GB) 78-ball BGA packaged devices and thirty-six 512Mx4 (DDP) (8GB) 78-ball BGA packaged devices. These DIMMs are manufactured using raw cards developed for broad industry use as reference designs. The use of these common design files minimizes electrical variation between suppliers. All NANYA DDR3 SDRAM DIMMs provide a high-performance, flexible 8-byte interface in a 5.25" long space-saving footprint. The DIMM is intended for use in applications operating of 533MHz/667MHz clock speeds and achieves high-speed data transfer rates of 1066Mbps/1333Mbps. Prior to any access operation, the device \overline{CAS} latency and burst/length/operation type must be programmed into the DIMM by address inputs A0-A13 and I/O inputs BA0-BA2 using the mode register set cycle.

The DIMM uses serial presence-detect implemented via a serial EEPROM using a standard IIC protocol. The first 128 bytes of SPD data are programmed and locked during module assembly. The remaining 128 bytes are available for use by the customer.

NT1GC72B89A0NL / NT2GC72B8PA0NL
NT4GC72B4NA1NL / NT4GC72B8NA1NL / NT8GTC72B4NA1NL
1GB: 128M x 72 / 2GB: 256M x 72 / 4GB: 512M x 72 / 8GB: 1G x 72
PC3-8500 / PC3-10600
Registered DDR3 SDRAM DIMM



Ordering Information

Part Number	Speed			Organization	Power	Leads	Note
NT1GC72B89A0NL-BE	DDR3-1066	PC3-8500	533MHz (1.875ns @ CL = 7)	128Mx72	1.5V	Gold	
NT1GC72B89A0NL-CG	DDR3-1333	PC3-10600	667MHz (1.5ns @ CL = 9)				
NT2GC72B8PA0NL-BE	DDR3-1066	PC3-8500	533MHz (1.875ns @ CL = 7)	256Mx72			
NT2GC72B8PA0NL-CG	DDR3-1333	PC3-10600	667MHz (1.5ns @ CL = 9)				
NT4GC72B4NA1NL-BE	DDR3-1066	PC3-8500	533MHz (1.875ns @ CL = 7)	512Mx72			
NT4GC72B4NA1NL-CG	DDR3-1333	PC3-10600	667MHz (1.5ns @ CL = 9)				
NT4GC72B8NA1NL-BE	DDR3-1066	PC3-8500	533MHz (1.875ns @ CL = 7)				
NT4GC72B8NA1NL-CG	DDR3-1333	PC3-10600	667MHz (1.5ns @ CL = 9)				
NT8GTC72B4NA1NL-BE	DDR3-1066	PC3-8500	533MHz (1.875ns @ CL = 7)	1Gx72			
NT8GTC72B4NA1NL-CG	DDR3-1333	PC3-10600	667MHz (1.5ns @ CL = 9)				

Pin Description

Pin Name	Description	Pin Name	Description
CK0, CK1	Clock Inputs, positive line	ODT0, ODT1	Active termination control lines
$\overline{CK0}$, $\overline{CK1}$	Clock Inputs, negative line	DQ0-DQ63	Data input/output
CKE0, CKE1	Clock Enable	DQS0-DQS17	Data strobes
\overline{RAS}	Row Address Strobe	$\overline{DQS0}$ - $\overline{DQS17}$	Data strobes complement
\overline{CAS}	Column Address Strobe	TDQS9-TDQS17	Termination data strobes
\overline{WE}	Write Enable	$\overline{TDQS9}$ - $\overline{TDQS17}$	Termination data strobes
$\overline{S0}$ - $\overline{S3}$	Chip Selects	DM0-DM8	Data Masks
A0-A9, A11, A13	Address Inputs	CB0-CB7	ECC Check Bits
A10/AP	Address Input/Auto-Precharge	\overline{EVENT}	Temperature event pin
A12/ \overline{BC}	Address Input/Burst Chop	\overline{RESET}	Reset pin
BA0-BA2	SDRAM Bank Address Inputs	V_{REFDQ} , V_{REFCA}	Input/Output Reference
SCL	Serial Presence Detect Clock Input	V_{DDSPD}	SPD and Temp sensor power
SDA	Serial Presence Detect Data input/output	SA0, SA1, SA2	Serial Presence Detect Address Inputs
Par_In	Parity bit for the Address and Control bus	Vtt	Termination voltage
$\overline{Err_Out}$	Parity error found on the Address and Control bus	V_{SS}	Ground
NC	No Connect	V_{DD}	Core and I/O power

NT1GC72B89A0NL / NT2GC72B8PA0NL
NT4GC72B4NA1NL / NT4GC72B8NA1NL / NT8GTC72B4NA1NL
1GB: 128M x 72 / 2GB: 256M x 72 / 4GB: 512M x 72 / 8GB: 1G x 72
PC3-8500 / PC3-10600
Registered DDR3 SDRAM DIMM



DDR3 SDRAM Pin Assignment

Pin	Front	Pin	Back	Pin	Front	Pin	Back	Pin	Front	Pin	Back	Pin	Front	Pin	Back
1	V _{REFDQ}	121	V _{SS}	31	DQ25	151	V _{SS}	61	A2	181	A1	91	DQ41	211	V _{SS}
2	V _{SS}	122	DQ4	32	V _{SS}	152	DM3/DQS12 / TDQS12	62	V _{DD}	182	V _{DD}	92	V _{SS}	212	DM5/DQS14 / TDQS14
3	DQ0	123	DQ5	33	DQS3	153	NC/DQS12 / TDQS12	63	NC	183	V _{DD}	93	DQS5	213	NC/DQS14 / TDQS14
4	DQ1	124	V _{SS}	34	DQS3	154	V _{SS}	64	NC ⁻	184	CK0	94	DQS5	214	V _{SS}
5	V _{SS}	125	DM0/DQS9 / TDQS9	35	V _{SS}	155	DQ30	65	V _{DD}	185	CK0	95	V _{SS}	215	DQ46
6	DQS0	126	NC/DQS9 / TDQS9	36	DQ26	156	DQ31	66	V _{DD}	186	V _{DD}	96	DQ42	216	DQ47
7	DQS0	127	V _{SS}	37	DQ27	157	V _{SS}	67	V _{REFCA}	187	EVENT	97	DQ43	217	V _{SS}
8	V _{SS}	128	DQ6	38	V _{SS}	158	CB4	68	Par_In/NC	188	A0	98	V _{SS}	218	DQ52
9	DQ2	129	DQ7	39	CB0	159	CB5	69	V _{DD}	189	V _{DD}	99	DQ48	219	DQ53
10	DQ3	130	V _{SS}	40	CB1	160	V _{SS}	70	A10/AP	190	BA1	100	DQ49	220	V _{SS}
11	V _{SS}	131	DQ12	41	V _{SS}	161	DM8/DQS17 / TDQS17	71	BA0	191	V _{DD}	101	V _{SS}	221	DM6/DQS15 / TDQS15
12	DQ8	132	DQ13	42	DQS8	162	NC/DQS17 / TDQS17	72	V _{DD}	192	RAS	102	DQS6	222	NC/DQS15 / TDQS15
13	DQ9	133	V _{SS}	43	DQS8	163	V _{SS}	73	WE	193	S0	103	DQS6	223	V _{SS}
14	V _{SS}	134	DM1/DQS10 / TDQS10	44	V _{SS}	164	CB6	74	CAS	194	V _{DD}	104	V _{SS}	224	DQ54
15	DQS1	135	NC/DQS10 / TDQS10	45	CB2	165	CB7	75	V _{DD}	195	ODT0	105	DQ50	225	DQ55
16	DQS1	136	V _{SS}	46	CB3	166	V _{SS}	76	S1/NC	196	A13	106	DQ51	226	V _{SS}
17	V _{SS}	137	DQ14	47	V _{SS}	167	NC	77	ODT1/NC	197	V _{DD}	107	V _{SS}	227	DQ60
18	DQ10	138	DQ15	48	V _{TT} /NC	168	RESET	78	V _{DD}	198	S3/NC	108	DQ56	228	DQ61
19	DQ11	139	V _{SS}	49	V _{TT} /NC	169	CKE1/NC	79	S2/NC	199	V _{SS}	109	DQ57	229	V _{SS}
20	V _{SS}	140	DQ20	50	CKE0	170	V _{DD}	80	V _{SS}	200	DQ36	110	V _{SS}	230	DM7/DQS16 / TDQS16
21	DQ16	141	DQ21	51	V _{DD}	171	NC	81	DQ32	201	DQ37	111	DQS7	231	NC/DQS16 / TDQS16
22	DQ17	142	V _{SS}	52	BA2	172	NC	82	DQ33	202	V _{SS}	112	DQS7	232	V _{SS}
23	V _{SS}	143	DM2/DQS11 / TDQS11	53	Err_Out/NC	173	V _{DD}	83	V _{SS}	203	DM4/DQS13 / TDQS13	113	V _{SS}	233	DQ62
24	DQS2	144	NC/DQS11 / TDQS11	54	V _{DD}	174	A12/BC	84	DQS4	204	NC/DQS13 / TDQS13	114	DQ58	234	DQ63
25	DQS2	145	V _{SS}	55	A11	175	A9	85	DQS4	205	V _{SS}	115	DQ59	235	V _{SS}
26	V _{SS}	146	DQ22	56	A7	176	V _{DD}	86	V _{SS}	206	DQ38	116	V _{SS}	236	V _{DDSPD}
27	DQ18	147	DQ23	57	V _{DD}	177	A8	87	DQ34	207	DQ39	117	SA0	237	SA1
28	DQ19	148	V _{SS}	58	A5	178	A6	88	DQ35	208	V _{SS}	118	SCL	238	SDA
29	V _{SS}	149	DQ28	59	A4	179	V _{DD}	89	V _{SS}	209	DQ44	119	SA2	239	V _{SS}
30	DQ24	150	DQ29	60	V _{DD}	180	A3	90	DQ40	210	DQ45	120	V _{TT}	240	V _{TT}

Note: 1. CKE1, S1 and ODT1 are for 2GB/4GB/8GB only.
 2. S2 and S3 are for 8GB only.
 3. TDQS9-TDQS17 and TDQS9-TDQS17 are for 1GB/2GB only.



Input/Output Functional Description

Symbol	Type	Polarity	Function
CK0, CK1 $\overline{\text{CK0}}, \overline{\text{CK1}}$	Input	Cross point	The system clock inputs. All address and command lines are sampled on the cross point of the rising edge of CK and falling edge of $\overline{\text{CK}}$. A Delay Locked Loop (DLL) circuit is driven from the clock inputs and output timing for read operations is synchronized to the input clock. However, CK1 and $\overline{\text{CK1}}$ are terminated but not used on RDIMMs.
CKE0, CKE1	Input	Active High	Activates the DDR3 SDRAM CK signal when high and deactivates the CK signal when low. By deactivating the clocks, CKE low initiates the Power Down mode or the Self Refresh mode.
$\overline{\text{S0}} - \overline{\text{S3}}$	Input	Active Low	Enable the command decoders for the associated rank of SDRAM when low and disables decoders when high. When decoders are disabled, new commands are ignored and previous operations continue. Other combinations of these input signals perform unique functions, including disabling all outputs (except CKE and ODT) of the register(s) on the DIMM or accessing internal control words in the register device(s). For modules with two registers, $\overline{\text{S2}}$ and $\overline{\text{S3}}$ operate similarly to $\overline{\text{S0}}$ and $\overline{\text{S1}}$ for the second set of register outputs or register control words.
$\overline{\text{RAS}}, \overline{\text{CAS}}, \overline{\text{WE}}$	Input	Active Low	When sampled at the positive rising edge of CK and falling edge of $\overline{\text{CK}}$, signals $\overline{\text{RAS}}, \overline{\text{CAS}}, \overline{\text{WE}}$ define the operation to be executed by the SDRAM.
ODT0, ODT1	Input	Active High	Asserts on-die termination for DQ, DM, DQS, and $\overline{\text{DQS}}$ signals if enabled via the DDR3 SDRAM mode register.
DM0 – DM8	Input	Active High	The data write masks, associated with one data byte. In Write mode, DM operates as a byte mask by allowing input data to be written if it is low but blocks the write operation if it is high. In Read mode, DM lines have no effect.
DQS0 – DQS17 $\overline{\text{DQS0}} - \overline{\text{DQS17}}$	I/O	Cross point	The data strobes, associated with one data byte, sourced with data transfers. In Write mode, the data strobe is sourced by the controller and is centered in the data window. In Read mode, the data strobe is sourced by the DDR3 SDRAM and is sent at the leading edge of the data window. $\overline{\text{DQS}}$ signals are complements, and timing is relative to the cross point of respective DQS and $\overline{\text{DQS}}$. If the module is to be operated in single ended strobe mode, all $\overline{\text{DQS}}$ signals must be tied on the system board to V_{SS} and DDR3 SDRAM mode registers programmed appropriately.
TDQS9 – TDQS17 $\overline{\text{TDQS9}} - \overline{\text{TDQS17}}$	Output		TDQS/ $\overline{\text{TDQS}}$ is applicable for x8 DRAMs only. When enabled via mode register A11=1 in MR1, DRAM will enable the same termination resistance function on TDQS/ $\overline{\text{TDQS}}$ that is applied to DQS/ $\overline{\text{DQS}}$. When disabled via mode register A11=0 in MR1, DM/TDQS will provide the data mask function TDQS is not used. X4/x16 DRAMs must disable the TDQS function via mode register A11=0 in MR1.
BA0, BA1, BA2	Input	-	Selects which DDR3 SDRAM internal bank of four or eight is activated.
A0 – A9 A10/AP A11 A12/ $\overline{\text{BC}}$ A13	Input	-	During a Bank Activate command cycle, defines the row address when sampled at the cross point of the rising edge of CK and falling edge of $\overline{\text{CK}}$. During a Read or Write command cycle, defines the column address when sampled at the cross point of the rising edge of CK and falling edge of $\overline{\text{CK}}$. In addition to the column address, AP is used to invoke autoprecharge operation at the end of the burst read or write cycle. If AP is high, autoprecharge is selected and BA0-BA _n defines the bank to be precharged. If AP is low, autoprecharge is disabled. During a Precharge command cycle, AP is used in conjunction with BA0-BA _n to control which bank(s) to precharge. If AP is high, all banks will be precharged regardless of the state of BA0-BA _n inputs. If AP is low, then BA0-BA _n are used to define which bank to precharge.
DQ0 – DQ63	Input	-	Data Input/Output pins.
CB0 – CB7	I/O	-	Check bits are used for ECC.
$V_{DD}, V_{DDSPD}, V_{SS}$	Supply	-	Power supplies for core, I/O, Serial Presence Detect, Temp sensor, and ground for the module.
V_{REFDQ}, V_{REFCA}	Supply	-	Reference voltage for SSTL15 inputs.
SDA	I/O	-	This is a bidirectional pin used to transfer data into or out of the SPD EEPROM and temp sensor. A resistor must be connected from the SDA bus line to V_{DDSPD} on the system planar to act as a pull up.
SCL	Input	-	This signal is used to clock data into and out of the SPD EEPROM and Temp sensor.
SA0 – SA2	Input	-	Address pins used to select the Serial Presence Detect and Temp sensor base address.
$\overline{\text{EVENT}}$	Output	-	The $\overline{\text{EVENT}}$ pin is reserved for use to flag critical module temperature.
$\overline{\text{RESET}}$	Input	-	This signal resets the DDR3 SDRAM.
$\overline{\text{Par_In}}$	Input	-	Parity bit for the Address and Control bus.
$\overline{\text{Err_Out}}$	Output	-	Parity error detected on the Address and Control bus. A resistor may be connected from bus line to V_{DD} on the system planar to act as a pull up.

NT1GC72B89A0NL / NT2GC72B8PA0NL
NT4GC72B4NA1NL / NT4GC72B8NA1NL / NT8GTC72B4NA1NL
1GB: 128M x 72 / 2GB: 256M x 72 / 4GB: 512M x 72 / 8GB: 1G x 72
PC3-8500 / PC3-10600
Registered DDR3 SDRAM DIMM



Functional Block Diagram (Part 1 of 2)

[1GB – 1 Rank, 128Mx8 DDR3 SDRAMs]

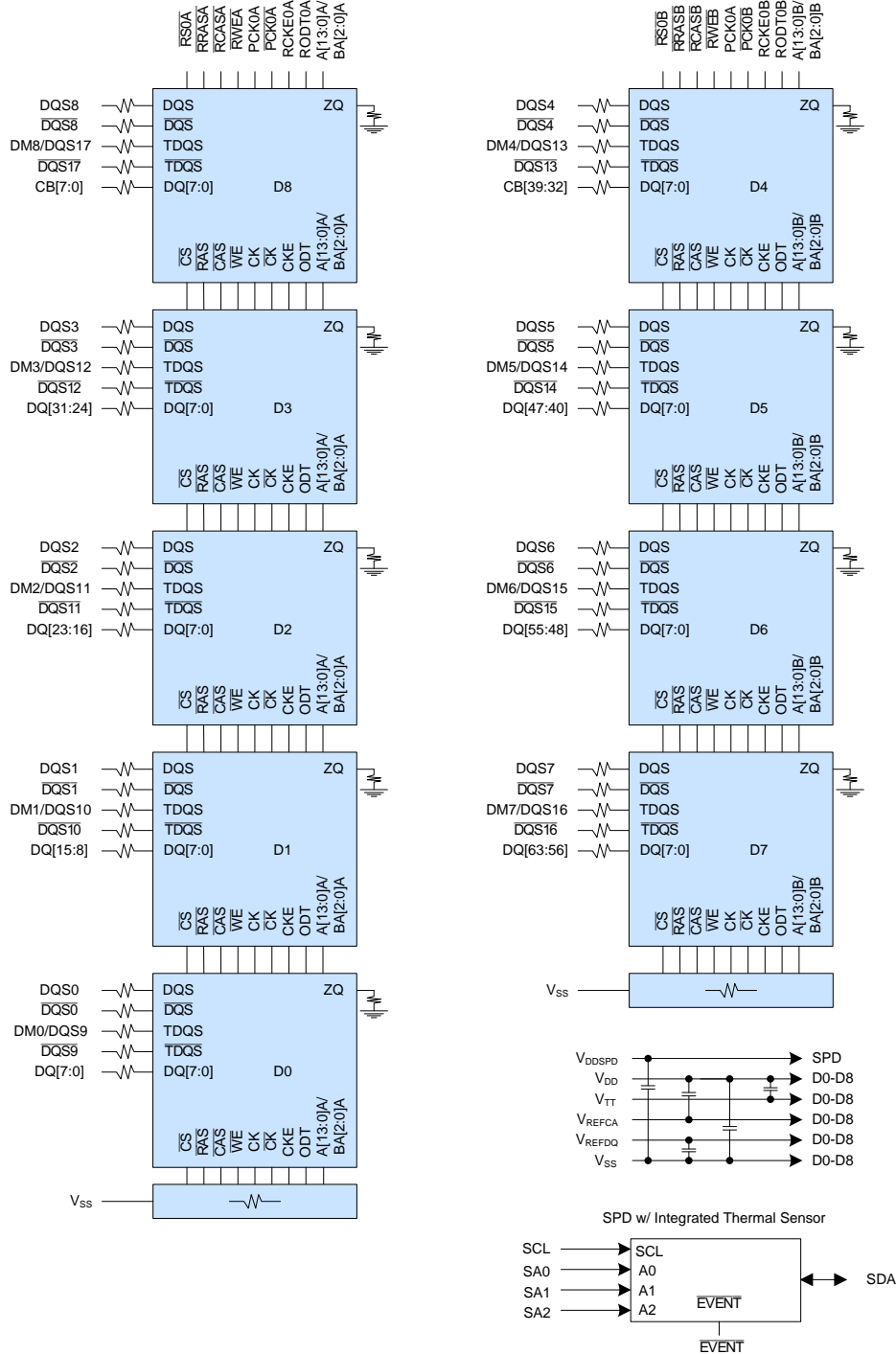

Notes :

1. DQ-to-I/O wiring is shown as recommended but may be changed.
2. ZQ resistors are 240Ω ±1%. For all other resistor values refer to the appropriate wiring diagram.

Functional Block Diagram (Part 2 of 2)

[1GB – 1 Rank, 128Mx8 DDR3 SDRAMs]

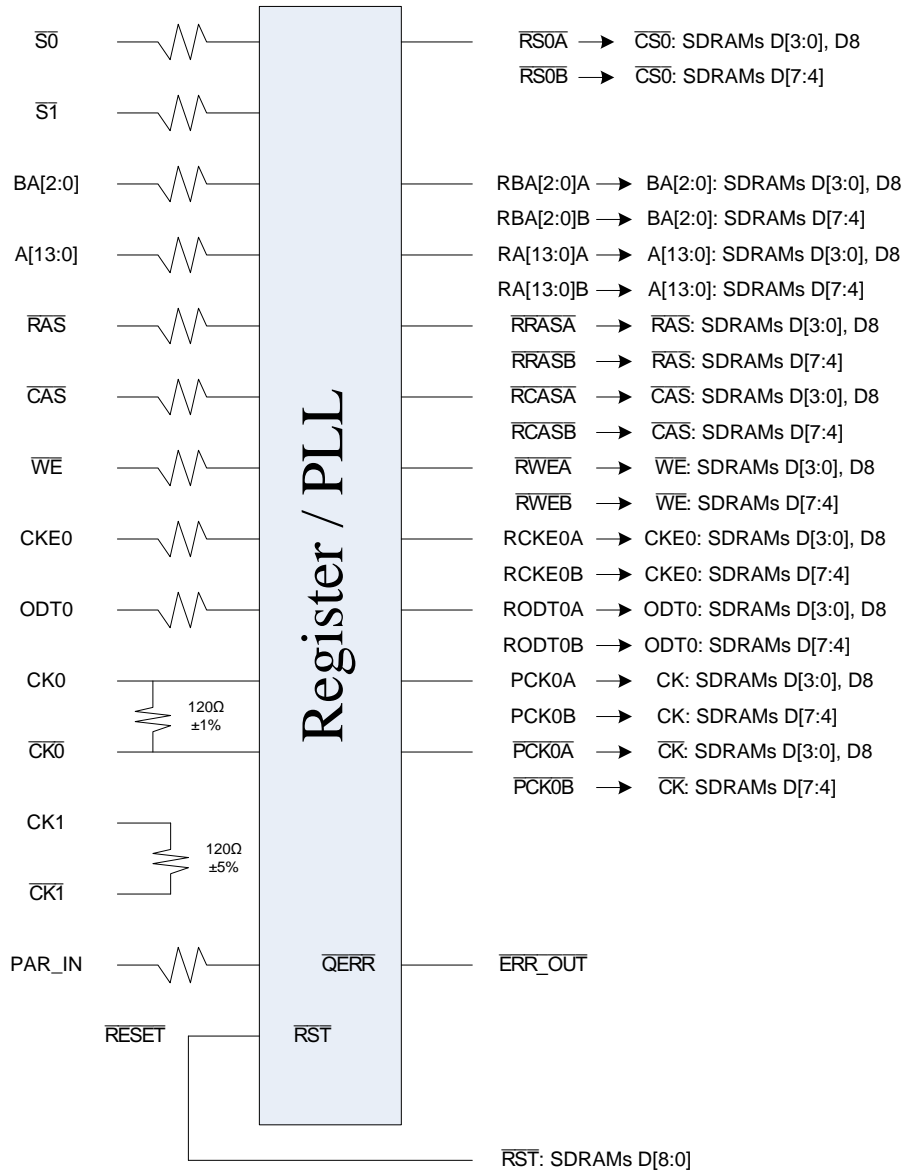

Note: S[3:2], CKE1, ODT1 are NC
(Unused register inputs ODT1 and CKE1 have a 330Ω resistor to ground)

NT1GC72B89A0NL / NT2GC72B8PA0NL
NT4GC72B4NA1NL / NT4GC72B8NA1NL / NT8GTC72B4NA1NL
1GB: 128M x 72 / 2GB: 256M x 72 / 4GB: 512M x 72 / 8GB: 1G x 72
PC3-8500 / PC3-10600
Registered DDR3 SDRAM DIMM



Functional Block Diagram (Part 1 of 3)

[4GB – 4 Ranks, 128Mx8 DDR3 SDRAMs]

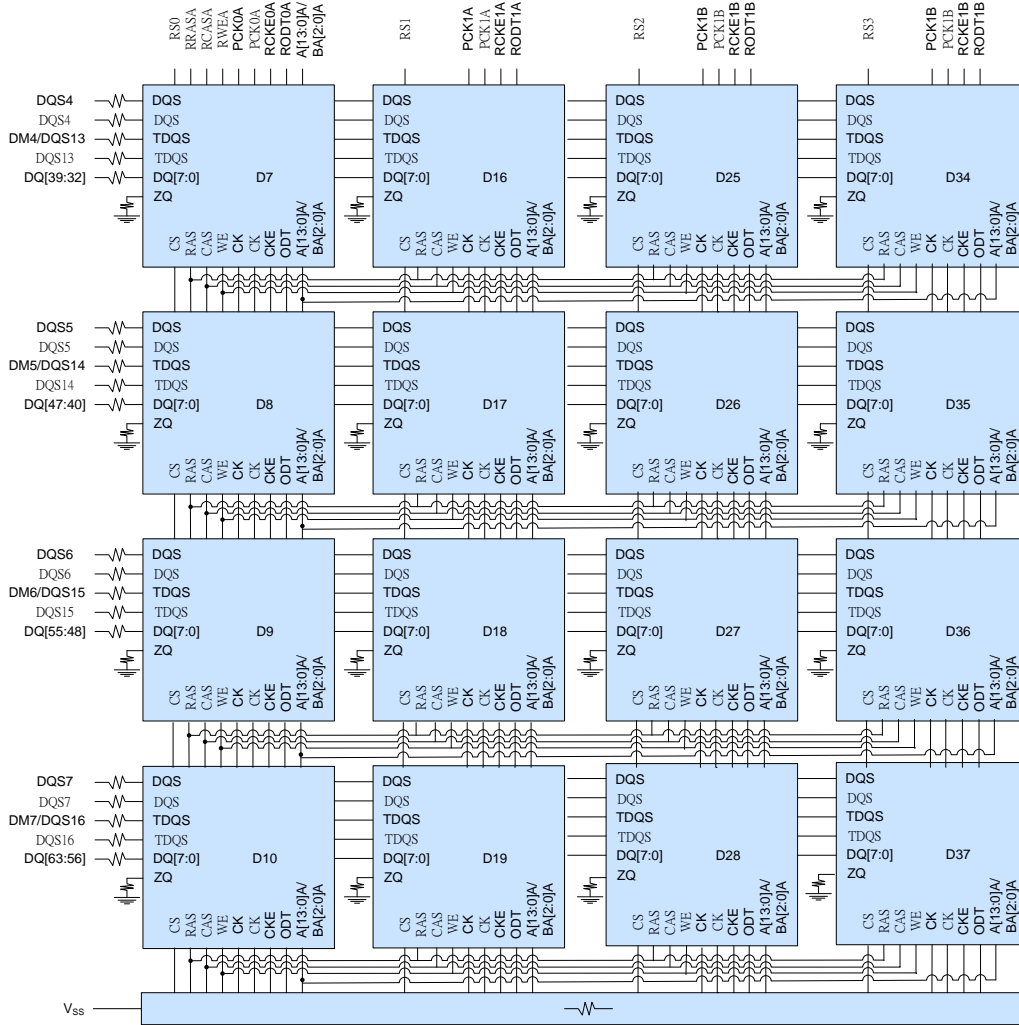

Notes :

1. DQ-to-I/O wiring is shown as recommended but may be changed.
2. ZQ resistors are $240\Omega \pm 1\%$. For all other resistor values refer to the appropriate wiring diagram.
3. Unless otherwise noted, resistor values are $15\Omega \pm 5\%$.
4. See the wiring diagrams for all resistors associated with the command, address and control bus.

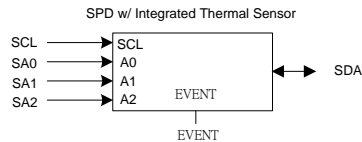
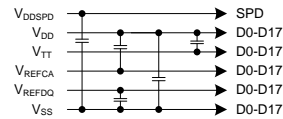

NT1GC72B89A0NL / NT2GC72B8PA0NL
NT4GC72B4NA1NL / NT4GC72B8NA1NL / NT8GTC72B4NA1NL
1GB: 128M x 72 / 2GB: 256M x 72 / 4GB: 512M x 72 / 8GB: 1G x 72
PC3-8500 / PC3-10600
Registered DDR3 SDRAM DIMM



Functional Block Diagram (Part 2 of 3)

[4GB – 4 Ranks, 128Mx8 DDR3 SDRAMs]

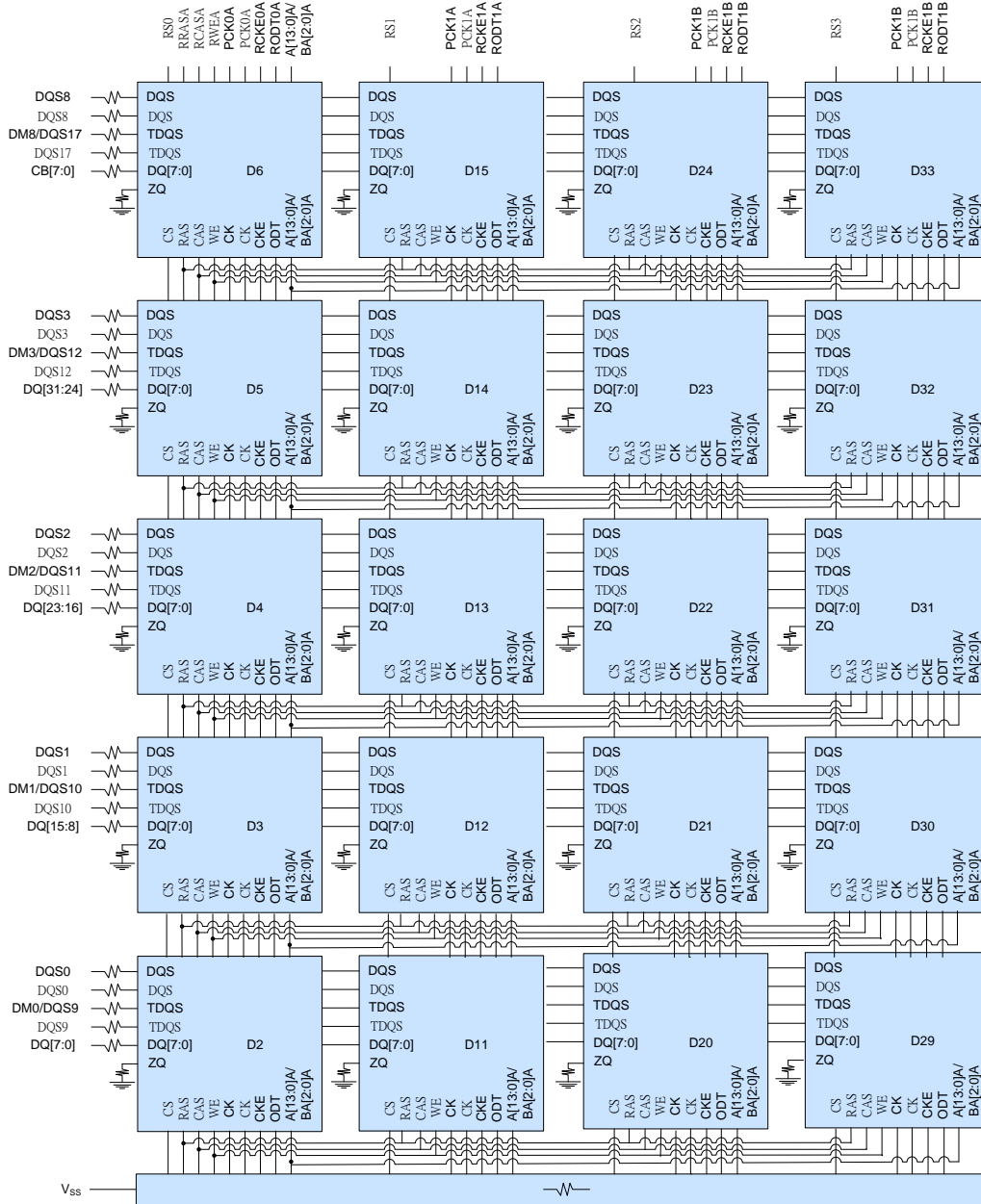

Functional Block Diagram (Part 3 of 3)

[4GB – 4 Ranks, 128Mx8 DDR3 SDRAMs]

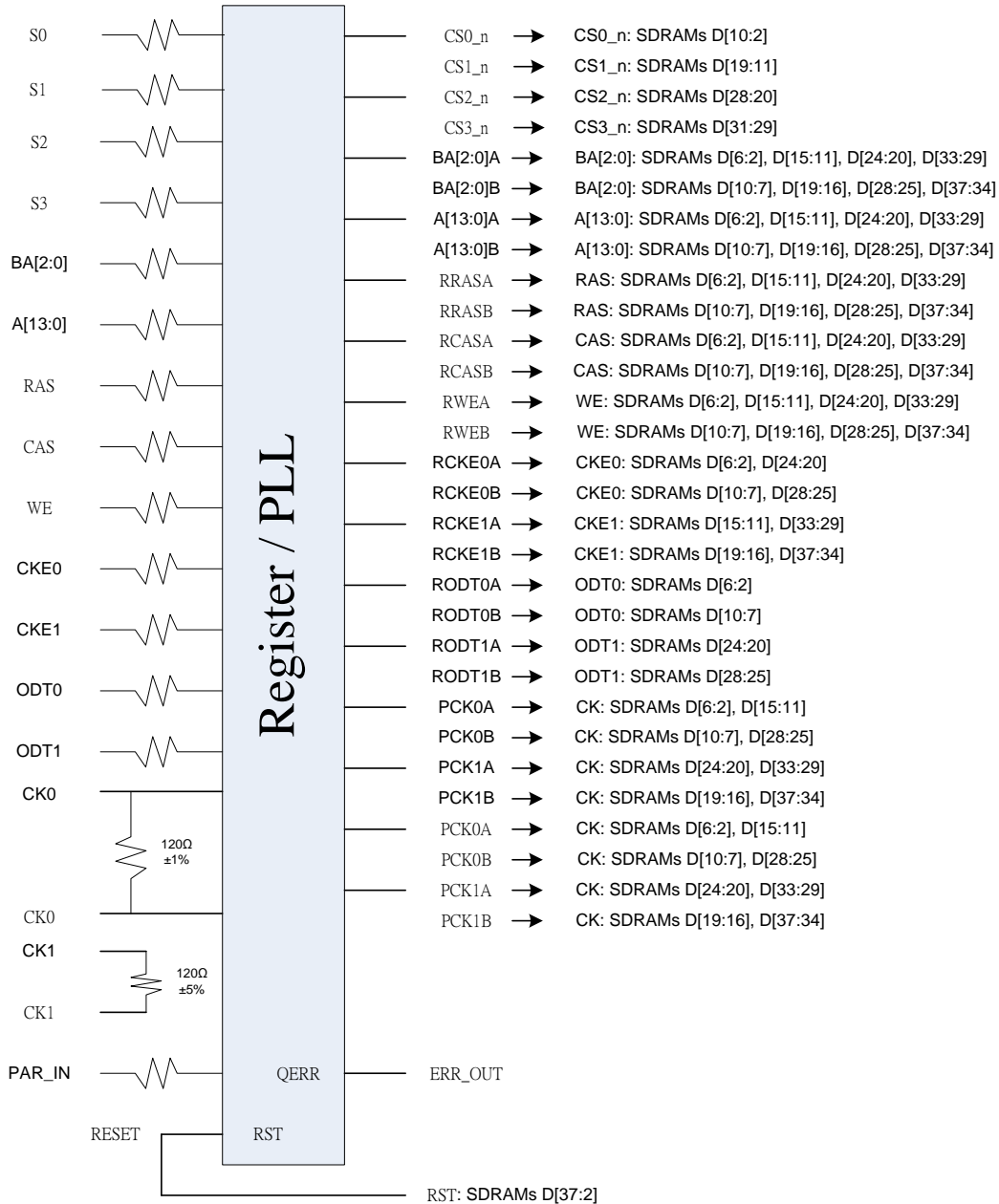

**NT1GC72B89A0NL / NT2GC72B8PA0NL
 NT4GC72B4NA1NL / NT4GC72B8NA1NL / NT8GTC72B4NA1NL
 1GB: 128M x 72 / 2GB: 256M x 72 / 4GB: 512M x 72 / 8GB: 1G x 72
 PC3-8500 / PC3-10600
 Registered DDR3 SDRAM DIMM**



Functional Block Diagram (Part 1 of 3)

[4GB – 2 Ranks, 256Mx4 DDR3 SDRAMs]

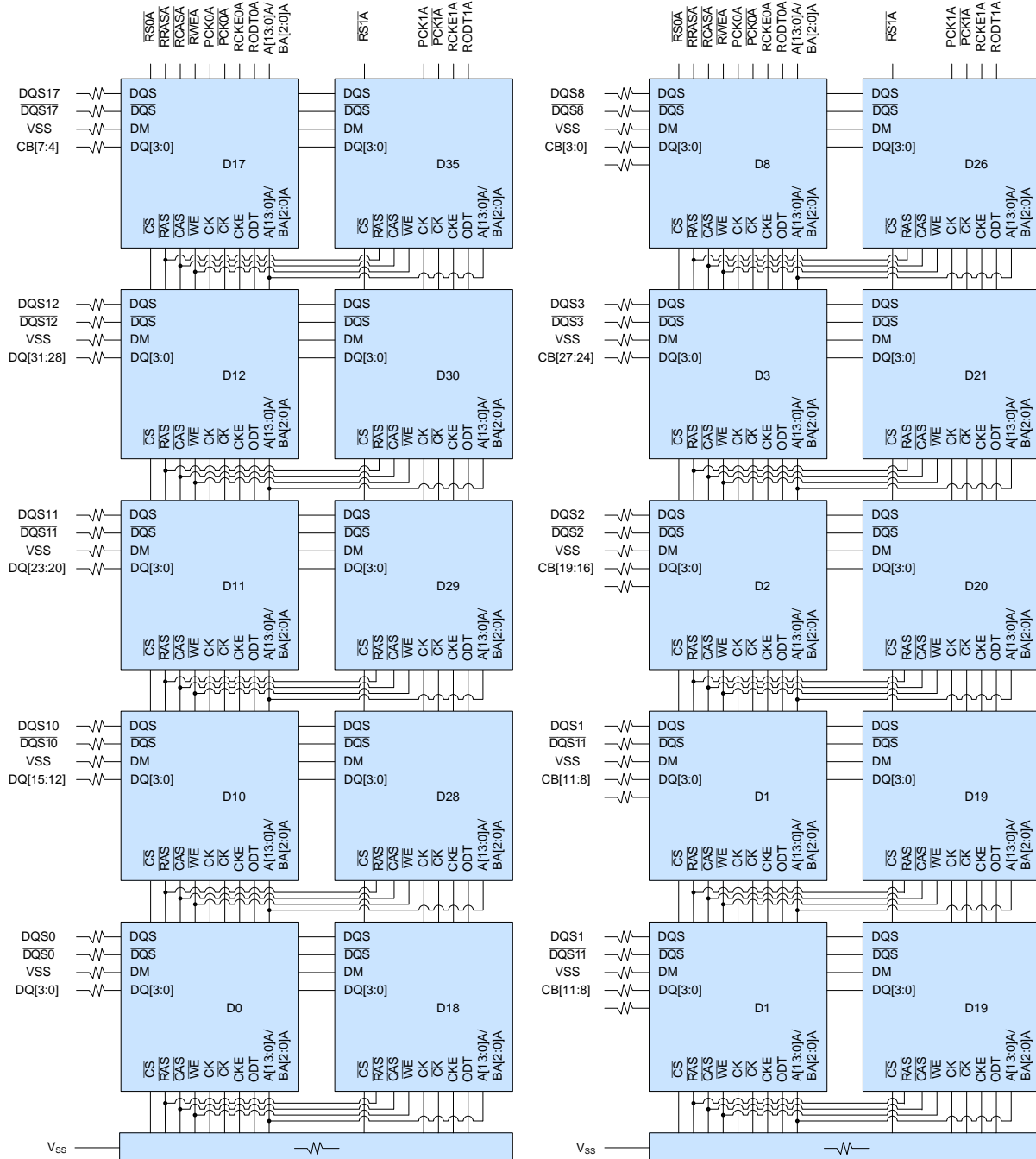



Functional Block Diagram (Part 2 of 3)

[4GB – 2 Ranks, 256Mx4 DDR3 SDRAMs]

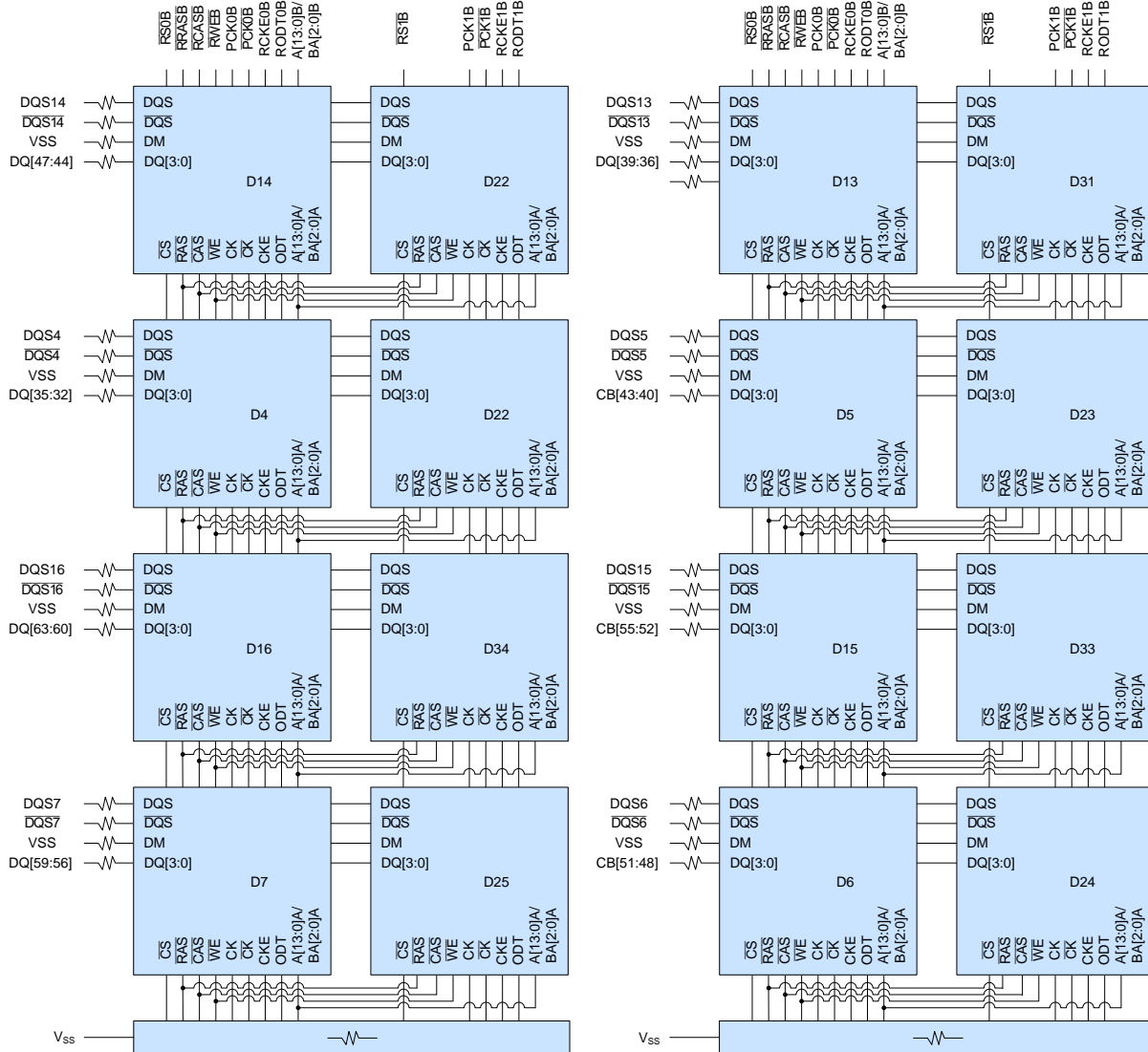

Notes :

1. DQ-to-I/O wiring is shown as recommended but may be changed.
2. ZQ pins of each SDRAM are connected to individual RZQ resistors ($240\Omega \pm 1\%$).
3. See the wiring diagrams for resistor values.

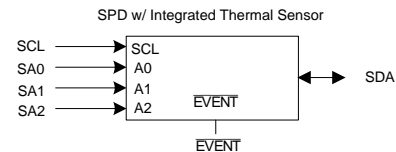
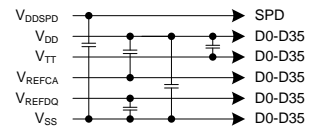

Functional Block Diagram (Part 3 of 3)

[4GB – 2 Ranks, 256Mx4 DDR3 SDRAMs]

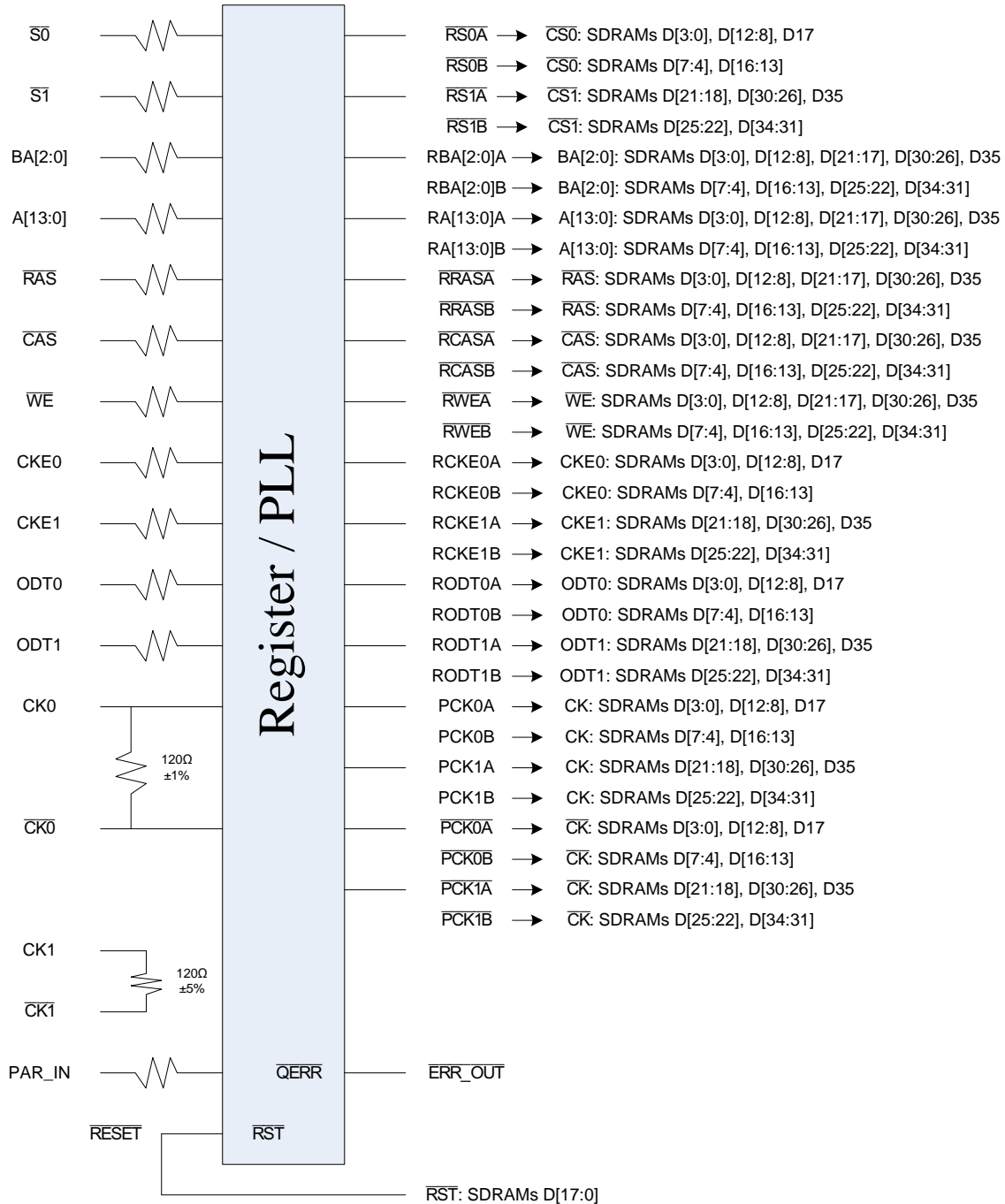

NT1GC72B89A0NL / NT2GC72B8PA0NL
NT4GC72B4NA1NL / NT4GC72B8NA1NL / NT8GTC72B4NA1NL
1GB: 128M x 72 / 2GB: 256M x 72 / 4GB: 512M x 72 / 8GB: 1G x 72
PC3-8500 / PC3-10600
Registered DDR3 SDRAM DIMM



Functional Block Diagram (Part 2 of 5)

[8GB – 4 Ranks, 512Mx4 (DDP) DDR3 SDRAMs]

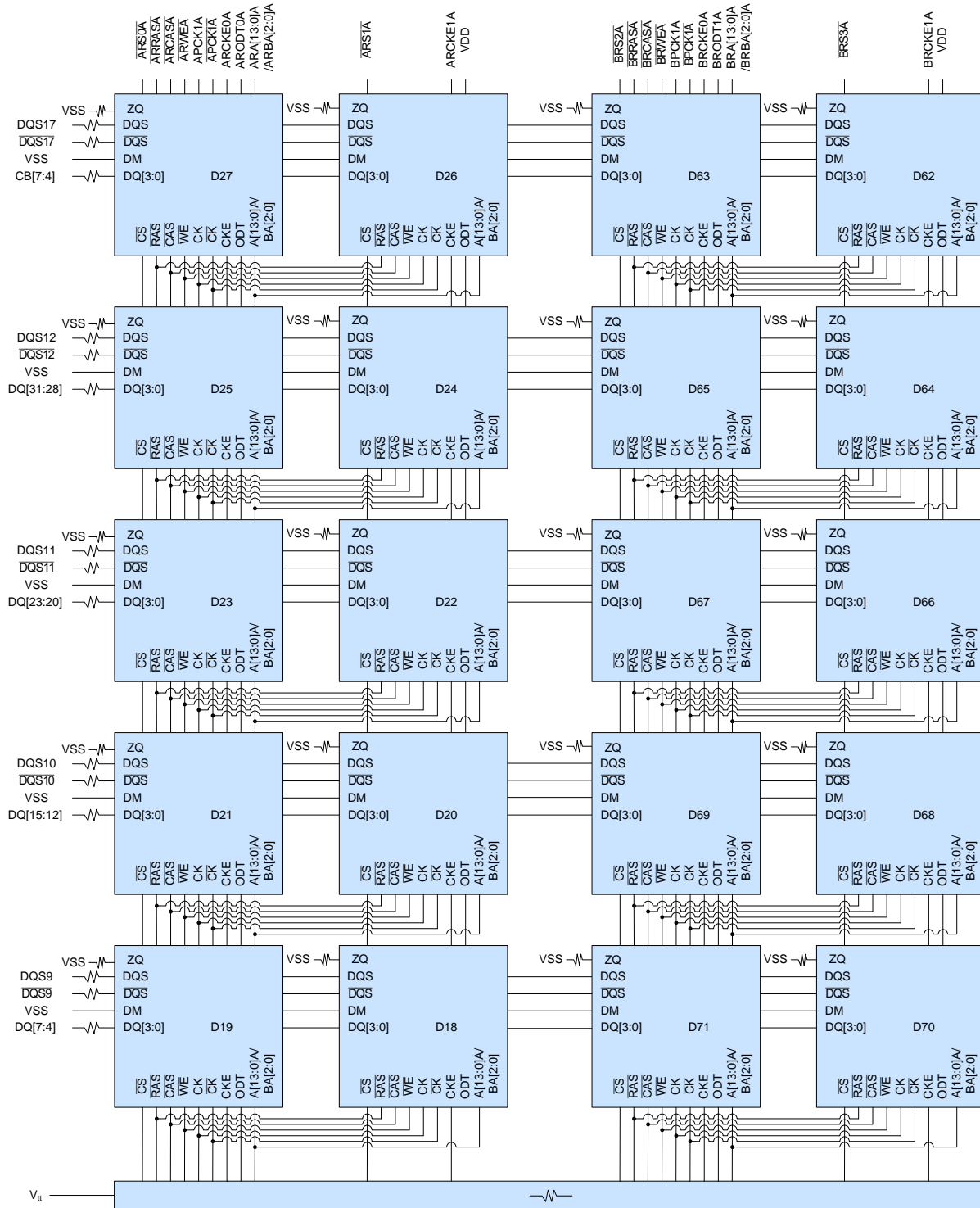



Functional Block Diagram (Part 3 of 5)

[8GB – 4 Ranks, 512Mx4 (DDP) DDR3 SDRAMs]

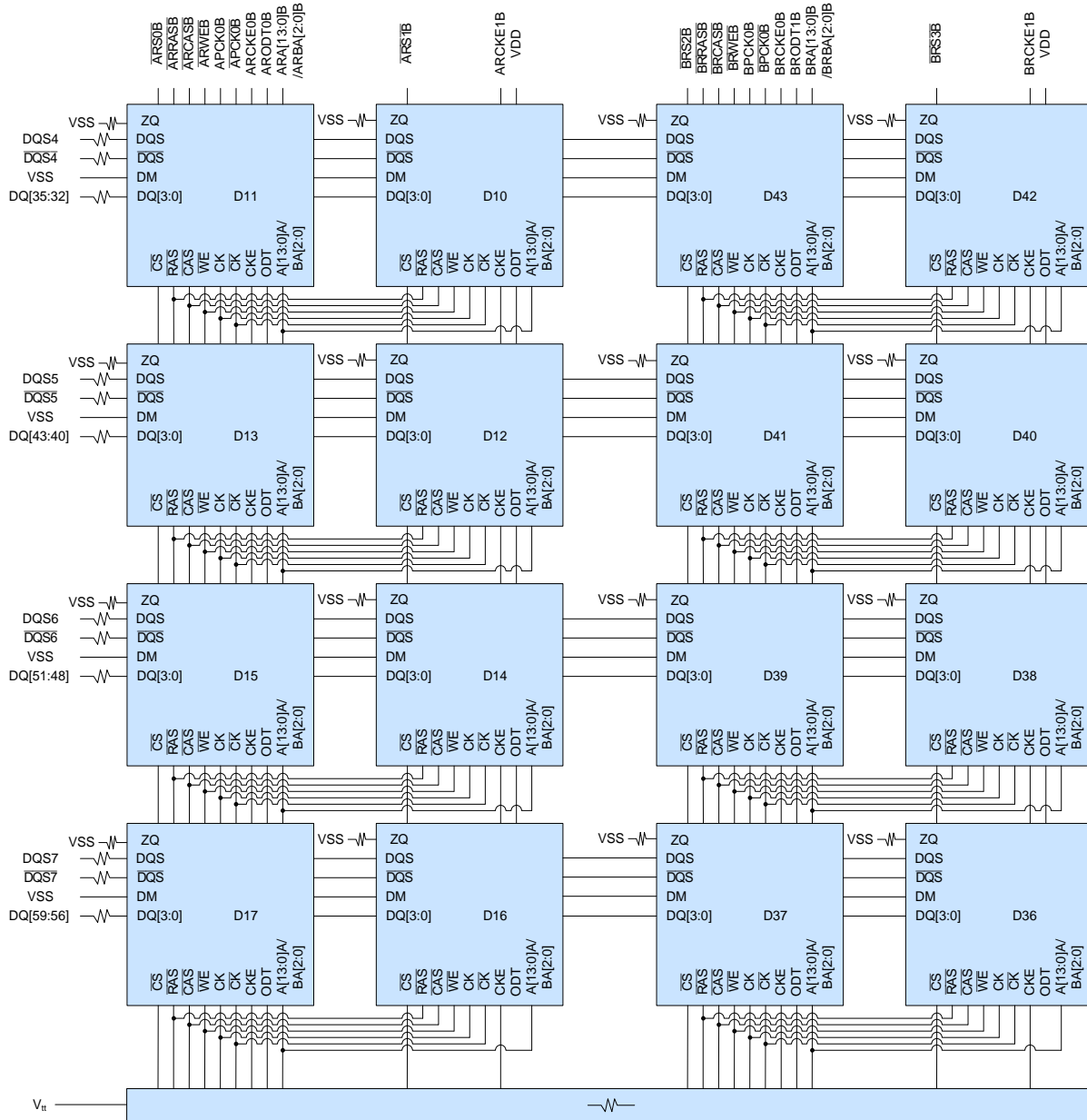



Functional Block Diagram (Part 4 of 5)

[8GB – 4 Ranks, 512Mx4 (DDP) DDR3 SDRAMs]

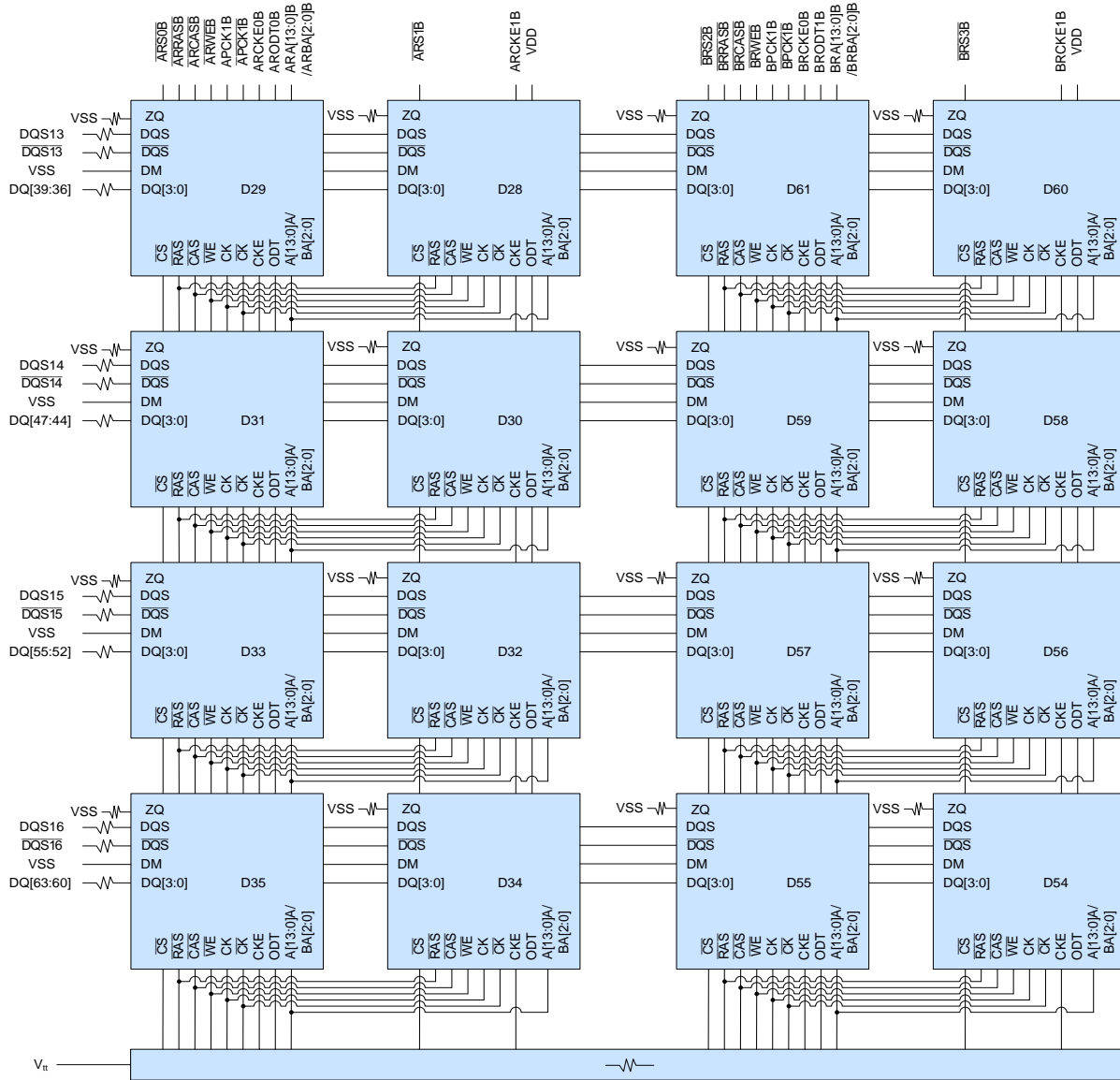

- Notes :**
1. DQ-to-I/O wiring is may be changed within a nibble.
 2. Resistor values are $15\Omega \pm 5\%$.
 2. ZQ resistors are $240\Omega \pm 1\%$.
 3. See the wiring diagrams for resistor values.

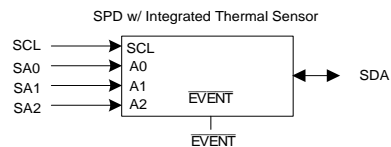
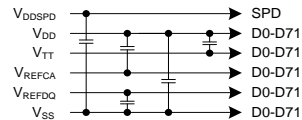



Functional Block Diagram (Part 5 of 5)

[8GB – 4 Ranks, 512Mx4 (DDP) DDR3 SDRAMs]

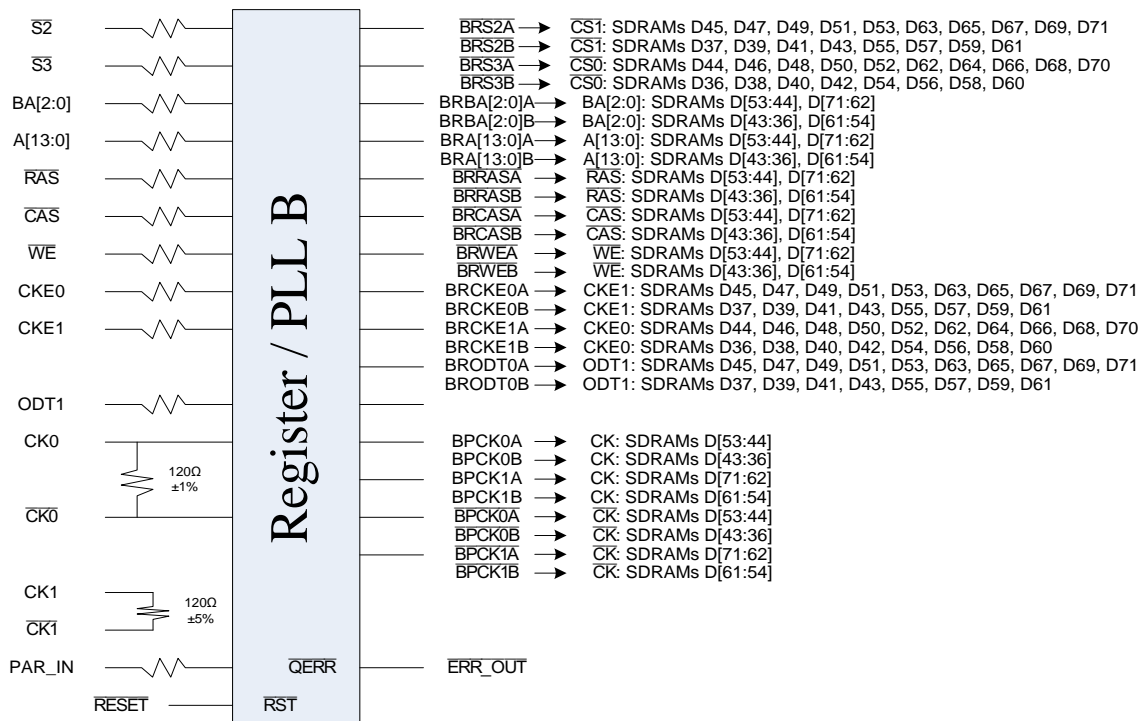
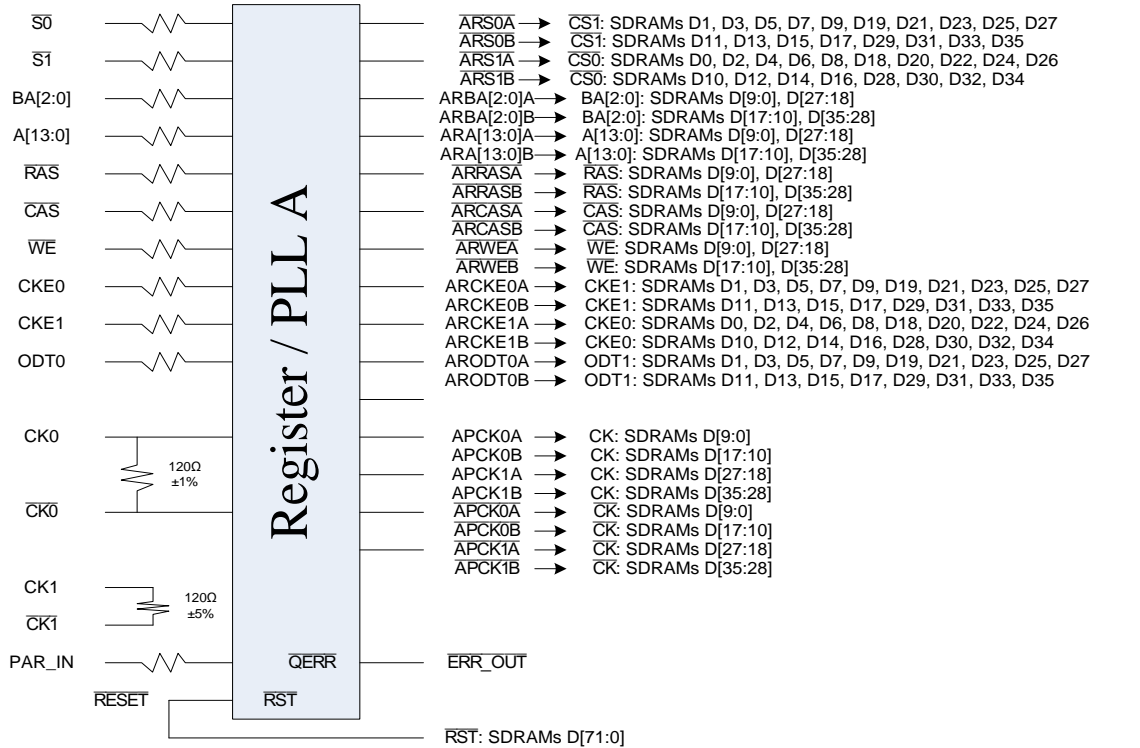

NT1GC72B89A0NL / NT2GC72B8PA0NL
NT4GC72B4NA1NL / NT4GC72B8NA1NL / NT8GTC72B4NA1NL
1GB: 128M x 72 / 2GB: 256M x 72 / 4GB: 512M x 72 / 8GB: 1G x 72
PC3-8500 / PC3-10600
Registered DDR3 SDRAM DIMM



Serial Presence Detect (Part 1 of 2) [NT1GC72B89A0NL, 1GB – 1 Ranks, 128Mx8 DDR3 SDRAMs]

Byte	Description	SPD Entry Value		Serial PD Data Entry (Hex.)	
		-BE	-CG	-BE	-CG
0	CRC range, EEPROM bytes, bytes used	CRC Covers Bytes: 0~116, Total SPD Bytes: 256, SPD Bytes Used: 176,	CRC Covers Bytes: 0~116, Total SPD Bytes: 256, SPD Bytes Used: 176,	92	92
1	SPD revision	Revision 1.0	Revision 1.0	10	10
2	DRAM device type	DDR3 SDRAM	DDR3 SDRAM	0B	0B
3	Module type (form factor)	RDIMM	RDIMM	01	01
4	SDRAM Device density and banks	8 banks, 1Gb	8 banks, 1Gb	02	02
5	SDRAM device row and column count	14 rows, 10 columns	14 rows, 10 columns	11	11
6	Module minimum nominal voltage	1.5 V	1.5 V	00	00
7	Module ranks and device DQ count	1 ranks, 8 bits	1 ranks, 8 bits	01	01
8	ECC tag and module memory Bus width	With ECC, 64bits	With ECC, 64bits	0B	0B
9	Fine timebase dividend/divisor (in ps)	2.5ps	2.5ps	52	52
10	Medium timebase dividend	1ns	1ns	01	01
11	Medium timebase divisor	8ns	8ns	08	08
12	Minimum SDRAM cycle time (tCKmin)	1.875ns	1.5ns	0F	0C
13	Reserved	Undefined	Undefined	00	00
14	CAS latencies supported	6,7,8	6,7,8,9	1C	3C
15	CAS latencies supported	Undefined	Undefined	00	00
16	Minimum CAS latency time (tAAmin)	13.125ns	13.125ns	69	69
17	Minimum write recovery time (tWRmin)	15ns	15ns	78	78
18	Minimum $\overline{\text{CAS}}$ -to- $\overline{\text{CAS}}$ delay (tRCDmin)	13.125ns	13.125ns	69	69
19	Minimum Row Active to Row Active delay (tRRDmin)	7.5ns	6ns	3C	30
20	Minimum row Precharge delay (tRPmin)	13.125ns	13.125ns	69	69
21	Upper nibble for tRAS and tRC	1,1	1,1	11	11
22	Minimum Active-to-Precharge delay (tRASmin)	37.5ns	36ns	2C	20
23	Minimum Active-to-Active/Refresh delay (tRCmin)	50.625ns	49.125ns	95	89
24	Minimum refresh recovery delay (tRFCmin) LSB	(Combo bytes 24,25)	(Combo bytes 24,25)	70	70
25	Minimum refresh recovery delay (tRFCmin) MSB	110ns	110ns	03	03
26	Minimum internal Write-to-Read command delay (tWTRmin)	7.5ns	7.5ns	3C	3C
27	Minimum internal Read-to-Precharge command delay (tRTPmin)	7.5ns	7.5ns	3C	3C
28	Minimum four active window delay (tFAWmin) LSB	(Combo byte 28, 29)	(Combo byte 28, 29)	01	00
29	Minimum four active window delay (tFAWmin) MSB	37.5ns	30ns	2C	F0
30	SDRAM device output drivers supported	RZQ / 6, RZQ / 7, DLL-Off Mode Support,	RZQ / 6, RZQ / 7, DLL-Off Mode Support,	83	83
31	SDRAM device thermal and refresh options	Extended Temperature Range, ASR, ODTS, PASR,	Extended Temperature Range, ASR, ODTS, PASR,	8D	8D
32	Module Thermal Sensor	Thermal Sensor Support	Thermal Sensor Support	80	80
33	SDRAM Device Type	Standard Monolithic Device	Standard Monolithic Device	00	00
34-59	Reserved	Undefined	Undefined	--	--
60	Module height (nominal)	29 < height ≤ 30 mm	29 < height ≤ 30 mm	0F	0F
61	Module thickness (Max)	Back: 1 < thickness ≤ 2 mm, Front: 1 < thickness ≤ 2 mm,	Back: 1 < thickness ≤ 2 mm, Front: 1 < thickness ≤ 2 mm,	11	11
62	Raw Card ID reference	Raw Card A	Raw Card A	00	00
63	DRAM address mapping edge connector	1 row, 1 register	1 row, 1 register	05	05
64-116	Reserved	Undefined	Undefined	--	--
117-118	Module manufacture ID	Nanya Technology	Nanya Technology	830B	830B
119-121	Module manufacturer Information	Undefined	Undefined	--	--
126-127	CRC	Calculated Value	Calculated Value	D6AC	9405

NT1GC72B89A0NL / NT2GC72B8PA0NL
NT4GC72B4NA1NL / NT4GC72B8NA1NL / NT8GTC72B4NA1NL
1GB: 128M x 72 / 2GB: 256M x 72 / 4GB: 512M x 72 / 8GB: 1G x 72
PC3-8500 / PC3-10600
Registered DDR3 SDRAM DIMM



Serial Presence Detect (Part 2 of 2) [NT1GC72B89A0NL, 1GB – 1 Ranks, 128Mx8 DDR3 SDRAMs]

Byte	Description	SPD Entry Value		Serial PD Data Entry (Hex.)	
		-BE	-CG	-BE	-CG
128-145	Module part number	ASCII values	ASCII values	--	--
146	Module die revision	Undefined	Undefined	00	00
147	Module PCB revision	Undefined	Undefined	00	00
148-149	DRAM device manufacturer ID	Nanya Technology	Nanya Technology	830B	830B
150-175	Manufacturer reserved	Undefined	Undefined	--	--
176-255	Customer reserved	Undefined	Undefined	--	--

Note1:
 NT1GC72B89A0NL-BE -> 4E54314743373242383941304E4C2D424520
 NT1GC72B89A0NL-CG -> 4E54314743373242383941304E4C2D434720

NT1GC72B89A0NL / NT2GC72B8PA0NL
NT4GC72B4NA1NL / NT4GC72B8NA1NL / NT8GTC72B4NA1NL
1GB: 128M x 72 / 2GB: 256M x 72 / 4GB: 512M x 72 / 8GB: 1G x 72
PC3-8500 / PC3-10600
Registered DDR3 SDRAM DIMM



Serial Presence Detect (Part 1 of 2) [NT2GC72B8PA0NL, 2GB – 2 Ranks, 128Mx8 DDR3 SDRAMs]

Byte	Description	SPD Entry Value		Serial PD Data Entry (Hex.)	
		-BE	-CG	-BE	-CG
0	CRC range, EEPROM bytes, bytes used	CRC Covers Bytes: 0~116, Total SPD Bytes: 256, SPD Bytes Used: 176,	CRC Covers Bytes: 0~116, Total SPD Bytes: 256, SPD Bytes Used: 176,	92	92
1	SPD revision	Revision 1.0	Revision 1.0	10	10
2	DRAM device type	DDR3 SDRAM	DDR3 SDRAM	0B	0B
3	Module type (form factor)	RDIMM	RDIMM	01	01
4	SDRAM Device density and banks	8 banks, 1Gb	8 banks, 1Gb	02	02
5	SDRAM device row and column count	14 rows, 10 columns	14 rows, 10 columns	11	11
6	Module minimum nominal voltage	1.5 V	1.5 V	00	00
7	Module ranks and device DQ count	2 ranks, 8 bits	2 ranks, 8 bits	09	09
8	ECC tag and module memory Bus width	With ECC, 64bits	With ECC, 64bits	0B	0B
9	Fine timebase dividend/divisor (in ps)	2.5ps	2.5ps	52	52
10	Medium timebase dividend	1ns	1ns	01	01
11	Medium timebase divisor	8ns	8ns	08	08
12	Minimum SDRAM cycle time (tCKmin)	1.875ns	1.5ns	0F	0C
13	Reserved	Undefined	Undefined	00	00
14	CAS latencies supported	6,7,8	6,7,8,9	1C	3C
15	CAS latencies supported	Undefined	Undefined	00	00
16	Minimum CAS latency time (tAAmin)	13.125ns	13.125ns	69	69
17	Minimum write recovery time (tWRmin)	15ns	15ns	78	78
18	Minimum CAS-to-CAS delay (tRCDmin)	13.125ns	13.125ns	69	69
19	Minimum Row Active to Row Active delay (tRRDmin)	7.5ns	6ns	3C	30
20	Minimum row Precharge delay (tRPmin)	13.125ns	13.125ns	69	69
21	Upper nibble for tRAS and tRC	1,1	1,1	11	11
22	Minimum Active-to-Precharge delay (tRASmin)	37.5ns	36ns	2C	20
23	Minimum Active-to-Active/Refresh delay (tRCmin)	50.625ns	49.125ns	95	89
24	Minimum refresh recovery delay (tRFCmin) LSB	(Combo bytes 24,25)	(Combo bytes 24,25)	70	70
25	Minimum refresh recovery delay (tRFCmin) MSB	110ns	110ns	03	03
26	Minimum internal Write-to-Read command delay (tWTRmin)	7.5ns	7.5ns	3C	3C
27	Minimum internal Read-to-Precharge command delay (tRTPmin)	7.5ns	7.5ns	3C	3C
28	Minimum four active window delay (tFAWmin) LSB	(Combo byte 28, 29)	(Combo byte 28, 29)	01	00
29	Minimum four active window delay (tFAWmin) MSB	37.5ns	30ns	2C	F0
30	SDRAM device output drivers supported	RZQ / 6, RZQ / 7, DLL-Off Mode Support,	RZQ / 6, RZQ / 7, DLL-Off Mode Support,	83	83
31	SDRAM device thermal and refresh options	Extended Temperature Range, ASR, ODTS, PASR,	Extended Temperature Range, ASR, ODTS, PASR,	8D	8D
32	Module Thermal Sensor	Thermal Sensor Support	Thermal Sensor Support	80	80
33	SDRAM Device Type	Standard Monolithic Device	Standard Monolithic Device	00	00
34-59	Reserved	Undefined	Undefined	--	--
60	Module height (nominal)	29 < height ≤ 30 mm	29 < height ≤ 30 mm	0F	0F
61	Module thickness (Max)	Back: 1 < thickness ≤ 2 mm, Front: 1 < thickness ≤ 2 mm,	Back: 1 < thickness ≤ 2 mm, Front: 1 < thickness ≤ 2 mm,	11	11
62	Raw Card ID reference	Raw Card B	Raw Card B	01	01
63	DRAM address mapping edge connector	1 row, 1 register	1 row, 1 register	05	05
64-116	Reserved	Undefined	Undefined	--	--
117-118	Module manufacture ID	Nanya Technology	Nanya Technology	830B	830B
119-121	Module manufacturer Information	Undefined	Undefined	--	--
126-127	CRC	Calculated Value	Calculated Value	24C4	666D

NT1GC72B89A0NL / NT2GC72B8PA0NL
NT4GC72B4NA1NL / NT4GC72B8NA1NL / NT8GTC72B4NA1NL
1GB: 128M x 72 / 2GB: 256M x 72 / 4GB: 512M x 72 / 8GB: 1G x 72
PC3-8500 / PC3-10600
Registered DDR3 SDRAM DIMM



Serial Presence Detect (Part 2 of 2) [NT2GC72B8PA0NL, 2GB – 2 Ranks, 128Mx8 DDR3 SDRAMs]

Byte	Description	SPD Entry Value		Serial PD Data Entry (Hex.)	
		-BE	-CG	-BE	-CG
128-145	Module part number	ASCII values	ASCII values	--	--
146	Module die revision	Undefined	Undefined	00	00
147	Module PCB revision	Undefined	Undefined	00	00
148-149	DRAM device manufacturer ID	Nanya Technology	Nanya Technology	830B	830B
150-175	Manufacturer reserved	Undefined	Undefined	--	--
176-255	Customer reserved	Undefined	Undefined	--	--

Note1:
 NT2GC72B8PA0NL-BE -> 4E54324743373242385041304E4C2D424520
 NT2GC72B8PA0NL-CG -> 4E54324743373242385041304E4C2D434720

NT1GC72B89A0NL / NT2GC72B8PA0NL
NT4GC72B4NA1NL / NT4GC72B8NA1NL / NT8GTC72B4NA1NL
1GB: 128M x 72 / 2GB: 256M x 72 / 4GB: 512M x 72 / 8GB: 1G x 72
PC3-8500 / PC3-10600
Registered DDR3 SDRAM DIMM



Serial Presence Detect (Part 1 of 2) [NT4GC72B8NA1NL, 4GB – 4 Ranks, 128Mx8 DDR3 SDRAMs]

Byte	Description	SPD Entry Value		Serial PD Data Entry (Hex.)	
		-BE	-CG	-BE	-CG
0	CRC range, EEPROM bytes, bytes used	CRC Covers Bytes: 0~116, Total SPD Bytes: 256, SPD Bytes Used: 176,	CRC Covers Bytes: 0~116, Total SPD Bytes: 256, SPD Bytes Used: 176,	92	92
1	SPD revision	Revision 1.0	Revision 1.0	10	10
2	DRAM device type	DDR3 SDRAM	DDR3 SDRAM	0B	0B
3	Module type (form factor)	RDIMM	RDIMM	01	01
4	SDRAM Device density and banks	8 banks, 1Gb	8 banks, 1Gb	02	02
5	SDRAM device row and column count	14 rows, 10 columns	14 rows, 10 columns	11	11
6	Module minimum nominal voltage	1.5 V	1.5 V	00	00
7	Module ranks and device DQ count	4 ranks, 8 bits	4 ranks, 8 bits	19	19
8	ECC tag and module memory Bus width	With ECC, 64bits	With ECC, 64bits	0B	0B
9	Fine timebase dividend/divisor (in ps)	2.5ps	2.5ps	52	52
10	Medium timebase dividend	1ns	1ns	01	01
11	Medium timebase divisor	8ns	8ns	08	08
12	Minimum SDRAM cycle time (tCKmin)	1.875ns	1.5ns	0F	0C
13	Reserved	Undefined	Undefined	00	00
14	CAS latencies supported	6,7,8	6,7,8,9	1C	3C
15	CAS latencies supported	Undefined	Undefined	00	00
16	Minimum CAS latency time (tAAmin)	13.125ns	13.125ns	69	69
17	Minimum write recovery time (tWRmin)	15ns	15ns	78	78
18	Minimum $\overline{\text{CAS}}$ -to- $\overline{\text{CAS}}$ delay (tRCDmin)	13.125ns	13.125ns	69	69
19	Minimum Row Active to Row Active delay (tRRDmin)	7.5ns	6ns	3C	30
20	Minimum row Precharge delay (tRPmin)	13.125ns	13.125ns	69	69
21	Upper nibble for tRAS and tRC	1,1	1,1	11	11
22	Minimum Active-to-Precharge delay (tRASmin)	37.5ns	36ns	2C	20
23	Minimum Active-to-Active/Refresh delay (tRCmin)	50.625ns	49.125ns	95	89
24	Minimum refresh recovery delay (tRFCmin) LSB	(Combo bytes 24,25)	(Combo bytes 24,25)	70	70
25	Minimum refresh recovery delay (tRFCmin) MSB	110ns	110ns	03	03
26	Minimum internal Write-to-Read command delay (tWTRmin)	7.5ns	7.5ns	3C	3C
27	Minimum internal Read-to-Precharge command delay (tRTPmin)	7.5ns	7.5ns	3C	3C
28	Minimum four active window delay (tFAWmin) LSB	(Combo byte 28, 29)	(Combo byte 28, 29)	01	00
29	Minimum four active window delay (tFAWmin) MSB	37.5ns	30ns	2C	F0
30	SDRAM device output drivers supported	RZQ / 6, RZQ / 7, DLL-Off Mode Support,	RZQ / 6, RZQ / 7, DLL-Off Mode Support,	83	83
31	SDRAM device thermal and refresh options	Extended Temperature Range, ASR, ODTS, PASR,	Extended Temperature Range, ASR, ODTS, PASR,	8D	8D
32	Module Thermal Sensor	Thermal Sensor Support	Thermal Sensor Support	80	80
33	SDRAM Device Type	Standard Monolithic Device	Standard Monolithic Device	00	00
34-59	Reserved	Undefined	Undefined	--	--
60	Module height (nominal)	29 < height ≤ 30 mm	29 < height ≤ 30 mm	0F	0F
61	Module thickness (Max)	Back: 3 < thickness ≤ 4 mm, Front: 3 < thickness ≤ 4 mm,	Back: 3 < thickness ≤ 4 mm, Front: 3 < thickness ≤ 4 mm,	33	33
62	Raw Card ID reference	Raw Card H	Raw Card H	07	07
63	DRAM address mapping edge connector	2 rows, 1 register	2 rows, 1 register	09	09
64-116	Reserved	Undefined	Undefined	--	--
117-118	Module manufacture ID	Nanya Technology	Nanya Technology	830B	830B
119-121	Module manufacturer Information	Undefined	Undefined	--	--
126-127	CRC	Calculated Value	Calculated Value	E6F3	A45A

NT1GC72B89A0NL / NT2GC72B8PA0NL
NT4GC72B4NA1NL / NT4GC72B8NA1NL / NT8GTC72B4NA1NL
1GB: 128M x 72 / 2GB: 256M x 72 / 4GB: 512M x 72 / 8GB: 1G x 72
PC3-8500 / PC3-10600
Registered DDR3 SDRAM DIMM



Serial Presence Detect (Part 2 of 2) [NT4GC72B8NA1NL, 4GB – 4 Ranks, 128Mx8 DDR3 SDRAMs]

Byte	Description	SPD Entry Value		Serial PD Data Entry (Hex.)	
		-BE	-CG	-BE	-CG
128-145	Module part number	ASCII values	ASCII values	--	--
146	Module die revision	Undefined	Undefined	00	00
147	Module PCB revision	Undefined	Undefined	00	00
148-149	DRAM device manufacturer ID	Nanya Technology	Nanya Technology	830B	830B
150-175	Manufacturer reserved	Undefined	Undefined	--	--
176-255	Customer reserved	Undefined	Undefined	--	--

Note1:
 NT4GC72B8NA1NL-BE -> 4E54344743373242384E41314E4C2D424520
 NT4GC72B8NA1NL-CG -> 4E54344743373242384E41314E4C2D434720

NT1GC72B89A0NL / NT2GC72B8PA0NL
NT4GC72B4NA1NL / NT4GC72B8NA1NL / NT8GTC72B4NA1NL
1GB: 128M x 72 / 2GB: 256M x 72 / 4GB: 512M x 72 / 8GB: 1G x 72
PC3-8500 / PC3-10600
Registered DDR3 SDRAM DIMM



Serial Presence Detect (Part 1 of 2) [NT4GC72B4NA1NL, 4GB – 2 Ranks, 256Mx4 DDR3 SDRAMs]

Byte	Description	SPD Entry Value		Serial PD Data Entry (Hex.)	
		-BE	-CG	-BE	-CG
0	CRC range, EEPROM bytes, bytes used	CRC Covers Bytes: 0~116, Total SPD Bytes: 256, SPD Bytes Used: 176,	CRC Covers Bytes: 0~116, Total SPD Bytes: 256, SPD Bytes Used: 176,	92	92
1	SPD revision	Revision 1.0	Revision 1.0	10	10
2	DRAM device type	DDR3 SDRAM	DDR3 SDRAM	0B	0B
3	Module type (form factor)	RDIMM	RDIMM	01	01
4	SDRAM Device density and banks	8 banks, 1Gb	8 banks, 1Gb	02	02
5	SDRAM device row and column count	14 rows, 11 columns	14 rows, 11 columns	12	12
6	Module minimum nominal voltage	1.5 V	1.5 V	00	00
7	Module ranks and device DQ count	2 ranks, 4 bits	2 ranks, 4 bits	08	08
8	ECC tag and module memory Bus width	With ECC, 64bits	With ECC, 64bits	0B	0B
9	Fine timebase dividend/divisor (in ps)	2.5ps	2.5ps	52	52
10	Medium timebase dividend	1ns	1ns	01	01
11	Medium timebase divisor	8ns	8ns	08	08
12	Minimum SDRAM cycle time (tCKmin)	1.875ns	1.5ns	0F	0C
13	Reserved	Undefined	Undefined	00	00
14	CAS latencies supported	6,7,8	6,7,8,9	1C	3C
15	CAS latencies supported	Undefined	Undefined	00	00
16	Minimum CAS latency time (tAAmin)	13.125ns	13.125ns	69	69
17	Minimum write recovery time (tWRmin)	15ns	15ns	78	78
18	Minimum $\overline{\text{CAS}}$ -to- $\overline{\text{CAS}}$ delay (tRCDmin)	13.125ns	13.125ns	69	69
19	Minimum Row Active to Row Active delay (tRRDmin)	7.5ns	6ns	3C	30
20	Minimum row Precharge delay (tRPmin)	13.125ns	13.125ns	69	69
21	Upper nibble for tRAS and tRC	1,1	1,1	11	11
22	Minimum Active-to-Precharge delay (tRASmin)	37.5ns	36ns	2C	20
23	Minimum Active-to-Active/Refresh delay (tRCmin)	50.625ns	49.125ns	95	89
24	Minimum refresh recovery delay (tRFCmin) LSB	(Combo bytes 24,25)	(Combo bytes 24,25)	70	70
25	Minimum refresh recovery delay (tRFCmin) MSB	110ns	110ns	03	03
26	Minimum internal Write-to-Read command delay (tWTRmin)	7.5ns	7.5ns	3C	3C
27	Minimum internal Read-to-Precharge command delay (tRTPmin)	7.5ns	7.5ns	3C	3C
28	Minimum four active window delay (tFAWmin) LSB	(Combo byte 28, 29)	(Combo byte 28, 29)	01	00
29	Minimum four active window delay (tFAWmin) MSB	37.5ns	30ns	2C	F0
30	SDRAM device output drivers supported	RZQ / 6, RZQ / 7, DLL-Off Mode Support,	RZQ / 6, RZQ / 7, DLL-Off Mode Support,	83	83
31	SDRAM device thermal and refresh options	Extended Temperature Range, ASR, ODTS, PASR,	Extended Temperature Range, ASR, ODTS, PASR,	8D	8D
32	Module Thermal Sensor	Thermal Sensor Support	Thermal Sensor Support	80	80
33	SDRAM Device Type	Standard Monolithic Device	Standard Monolithic Device	00	00
34-59	Reserved	Undefined	Undefined	--	--
60	Module height (nominal)	29 < height ≤ 30 mm	29 < height ≤ 30 mm	0F	0F
61	Module thickness (Max)	Back: 3 < thickness ≤ 4 mm, Front: 3 < thickness ≤ 4 mm,	Back: 3 < thickness ≤ 4 mm, Front: 3 < thickness ≤ 4 mm,	33	33
62	Raw Card ID reference	Raw Card E	Raw Card E	04	04
63	DRAM address mapping edge connector	2 rows, 1 register	2 rows, 1 register	09	09
64-116	Reserved	Undefined	Undefined	--	--
117-118	Module manufacture ID	Nanya Technology	Nanya Technology	830B	830B
119-121	Module manufacturer Information	Undefined	Undefined	--	--
126-127	CRC	Calculated Value	Calculated Value	D041	92E8

NT1GC72B89A0NL / NT2GC72B8PA0NL
NT4GC72B4NA1NL / NT4GC72B8NA1NL / NT8GTC72B4NA1NL
1GB: 128M x 72 / 2GB: 256M x 72 / 4GB: 512M x 72 / 8GB: 1G x 72
PC3-8500 / PC3-10600
Registered DDR3 SDRAM DIMM



Serial Presence Detect (Part 2 of 2) [NT4GC72B4NA1NL, 4GB – 2 Ranks, 256Mx4 DDR3 SDRAMs]

Byte	Description	SPD Entry Value		Serial PD Data Entry (Hex.)	
		-BE	-CG	-BE	-CG
128-145	Module part number	ASCII values	ASCII values	--	--
146	Module die revision	Undefined	Undefined	00	00
147	Module PCB revision	Undefined	Undefined	00	00
148-149	DRAM device manufacturer ID	Nanya Technology	Nanya Technology	830B	830B
150-175	Manufacturer reserved	Undefined	Undefined	--	--
176-255	Customer reserved	Undefined	Undefined	--	--

Note1:
 NT4GC72B4NA1NL-BE -> 4E54344743373242344E41314E4C2D424520
 NT4GC72B4NA1NL-CG -> 4E54344743373242344E41314E4C2D434720

NT1GC72B89A0NL / NT2GC72B8PA0NL
NT4GC72B4NA1NL / NT4GC72B8NA1NL / NT8GTC72B4NA1NL
1GB: 128M x 72 / 2GB: 256M x 72 / 4GB: 512M x 72 / 8GB: 1G x 72
PC3-8500 / PC3-10600
Registered DDR3 SDRAM DIMM



Serial Presence Detect (Part 1 of 2) [NT8GTC72B4NA1NL, 8GB – 4 Ranks, 512Mx4 DDR3 SDRAMs]

Byte	Description	SPD Entry Value		Serial PD Data Entry (Hex.)	
		-BE	-CG	-BE	-CG
0	CRC range, EEPROM bytes, bytes used	CRC Covers Bytes: 0~116, Total SPD Bytes: 256, SPD Bytes Used: 176,	CRC Covers Bytes: 0~116, Total SPD Bytes: 256, SPD Bytes Used: 176,	92	92
1	SPD revision	Revision 1.0	Revision 1.0	10	10
2	DRAM device type	DDR3 SDRAM	DDR3 SDRAM	0B	0B
3	Module type (form factor)	RDIMM	RDIMM	01	01
4	SDRAM Device density and banks	8 banks, 1Gb	8 banks, 1Gb	02	02
5	SDRAM device row and column count	14 rows, 11 columns	14 rows, 11 columns	12	12
6	Module minimum nominal voltage	1.5 V	1.5 V	00	00
7	Module ranks and device DQ count	4 ranks, 4 bits	4 ranks, 4 bits	18	18
8	ECC tag and module memory Bus width	With ECC, 64bits	With ECC, 64bits	0B	0B
9	Fine timebase dividend/divisor (in ps)	2.5ps	2.5ps	52	52
10	Medium timebase dividend	1ns	1ns	01	01
11	Medium timebase divisor	8ns	8ns	08	08
12	Minimum SDRAM cycle time (tCKmin)	1.875ns	1.5ns	0F	0C
13	Reserved	Undefined	Undefined	00	00
14	CAS latencies supported	6,7,8	6,7,8,9	1C	3C
15	CAS latencies supported	Undefined	Undefined	00	00
16	Minimum CAS latency time (tAmin)	13.125ns	13.125ns	69	69
17	Minimum write recovery time (tWRmin)	15ns	15ns	78	78
18	Minimum $\overline{\text{CAS}}$ -to- $\overline{\text{CAS}}$ delay (tRCDmin)	13.125ns	13.125ns	69	69
19	Minimum Row Active to Row Active delay (tRRDmin)	7.5ns	6ns	3C	30
20	Minimum row Precharge delay (tRPmin)	13.125ns	13.125ns	69	69
21	Upper nibble for tRAS and tRC	1,1	1,1	11	11
22	Minimum Active-to-Precharge delay (tRASmin)	37.5ns	36ns	2C	20
23	Minimum Active-to-Active/Refresh delay (tRCmin)	50.625ns	49.125ns	95	89
24	Minimum refresh recovery delay (tRFCmin) LSB	(Combo bytes 24,25)	(Combo bytes 24,25)	70	70
25	Minimum refresh recovery delay (tRFCmin) MSB	110ns	110ns	03	03
26	Minimum internal Write-to-Read command delay (tWTRmin)	7.5ns	7.5ns	3C	3C
27	Minimum internal Read-to-Precharge command delay (tRTPmin)	7.5ns	7.5ns	3C	3C
28	Minimum four active window delay (tFAWmin) LSB	(Combo byte 28, 29)	(Combo byte 28, 29)	01	00
29	Minimum four active window delay (tFAWmin) MSB	37.5ns	30ns	2C	F0
30	SDRAM device output drivers supported	RZQ / 6, RZQ / 7, DLL-Off Mode Support,	RZQ / 6, RZQ / 7, DLL-Off Mode Support,	83	83
31	SDRAM device thermal and refresh options	Extended Temperature Range, ASR, ODTS, PASR,	Extended Temperature Range, ASR, ODTS, PASR,	8D	8D
32	Module Thermal Sensor	Thermal Sensor Support	Thermal Sensor Support	80	80
33	SDRAM Device Type	Dual Die Package	Dual Die Package	80	80
34-59	Reserved	Undefined	Undefined	--	--
60	Module height (nominal)	29 < height ≤ 30 mm	29 < height ≤ 30 mm	0F	0F
61	Module thickness (Max)	Back: 3 < thickness ≤ 4 mm, Front: 3 < thickness ≤ 4 mm,	Back: 3 < thickness ≤ 4 mm, Front: 3 < thickness ≤ 4 mm,	33	33
62	Raw Card ID reference	Raw Card F	Raw Card F	05	05
63	DRAM address mapping edge connector	2 rows, 2 registers	2 rows, 2 registers	0A	0A
64-116	Reserved	Undefined	Undefined	--	--
117-118	Module manufacture ID	Nanya Technology	Nanya Technology	830B	830B
119-121	Module manufacturer Information	Undefined	Undefined	--	--
126-127	CRC	Calculated Value	Calculated Value	132C	5185

NT1GC72B89A0NL / NT2GC72B8PA0NL
NT4GC72B4NA1NL / NT4GC72B8NA1NL / NT8GTC72B4NA1NL
1GB: 128M x 72 / 2GB: 256M x 72 / 4GB: 512M x 72 / 8GB: 1G x 72
PC3-8500 / PC3-10600
Registered DDR3 SDRAM DIMM



Serial Presence Detect (Part 2 of 2) [NT8GTC72B4NA1NL, 8GB – 4 Ranks, 512Mx4 DDR3 SDRAMs]

Byte	Description	SPD Entry Value		Serial PD Data Entry (Hex.)	
		-BE	-CG	-BE	-CG
128-145	Module part number	ASCII values	ASCII values	--	--
146	Module die revision	Undefined	Undefined	00	00
147	Module PCB revision	Undefined	Undefined	00	00
148-149	DRAM device manufacturer ID	Nanya Technology	Nanya Technology	830B	830B
150-175	Manufacturer reserved	Undefined	Undefined	--	--
176-255	Customer reserved	Undefined	Undefined	--	--

Note1:
 NT8GTC72B4NA1NL-BE -> 4E5438475443373242344E41314E4C2D4245
 NT8GTC72B4NA1NL-CG -> 4E5438475443373242344E41314E4C2D4347



Environmental Requirements

Symbol	Parameter	Rating	Units	Note
T _{OPR}	Module Operating Temperature Range (ambient)	0 to 55	°C	3
H _{OPR}	Operating Humidity (relative)	10 to 90	%	1
T _{STG}	Storage Temperature (Plastic)	-55 to 100	°C	1
H _{STG}	Storage Humidity (without condensation)	5 to 95	%	1
P _{BAR}	Barometric Pressure (operating & storage)	105 to 69	K Pascal	1, 2

Note:

- Stresses greater than those listed may cause permanent damage to the device. This is a stress rating only and device functional operation at or above the conditions indicated is not implied. Exposure to absolute maximum rating conditions for extended periods may affect reliability.
- Up to 9850 ft.
- The component maximum case temperature shall not exceed the value specified in the component spec.

Absolute Maximum DC Ratings

Symbol	Parameter	Rating	Units	Note
V _{DD}	Voltage on VDD pins relative to Vss	-0.4 V ~ 1.975 V	V	1, 3
V _{DDQ}	Voltage on VDDQ pins relative to Vss	-0.4 V ~ 1.975 V	V	1, 3
V _{IN} , V _{OUT}	Voltage on I/O pins relative to Vss	-0.4 V ~ 1.975 V	V	1
T _{STG}	Storage Temperature	-55 to +100	°C	1, 2

Note:

- Stresses greater than those listed under "Absolute Maximum Ratings" may cause permanent damage to the device. This is a stress rating only and functional operation of the device at these or any other conditions above those indicated in the operational sections of this specification is not implied. Exposure to absolute maximum rating conditions for extended periods may affect reliability
- Storage Temperature is the case surface temperature on the center/top side of the DRAM.
- VDD and VDDQ must be within 300 mV of each other at all times; and VREF must be not greater

Operating temperature Conditions

Symbol	Parameter	Rating	Units	Note
T _{OPER}	Normal Operating Temperature Range	0 to 85	°C	1, 2
	Extended Temperature Range (Optional)	85 to 95	°C	1, 3

Note:

- Operating Temperature TOPER is the case surface temperature on the center / top side of the DRAM.
- The Normal Temperature Range specifies the temperatures where all DRAM specifications will be supported. During operation, the DRAM case temperature must be maintained between 0 to 85 °C under all operating conditions
- Some applications require operation of the DRAM in the Extended Temperature Range between 85 °C and 95 °C case temperature. Full specifications are supported in this range, but the following additional conditions apply:
 - Refresh commands must be doubled in frequency, therefore reducing the Refresh interval tREFI to 3.9 μs. It is also possible to specify a component with 1X refresh (tREFI to 7.8μs) in the Extended Temperature Range. Please refer to supplier data sheet and/or the DIMM SPD for option availability.
 - If Self-Refresh operation is required in the Extended Temperature Range, then it is mandatory to either use the Manual Self-Refresh mode with Extended Operating Temperature Range capability (MR2 A6 = 0b and MR2 A7 = 1b) or enable the optional Auto Self-Refresh mode (MR2 A6 = 1b and MR2 A7 = 0b). Please refer to the supplier data sheet and/or the DIMM SPD for Auto Self-Refresh option availability, Extended Temperature Range support and tREFI requirements in the Extended Temperature Range.



DC Electrical Characteristics and Operating Conditions

Symbol	Parameter	Min	Typ	Max	Units	Notes
VDD	Supply Voltage	1.425	1.5	1.575	V	1,2
VDDQ	Output Supply Voltage	1.425	1.5	1.575	V	1,2

Note:

- Under all conditions VDDQ must be less than or equal to VDD.
- VDDQ tracks with VDD. AC parameters are measured with VDD and VDDQ tied together.

Single-Ended AC and DC Input Levels for Command and Address

Symbol	Parameter	DDR3-1066 (-BE)		DDR3-1333 (-CG)		Units	Note
		Min.	Max.	Min.	Max.		
VIH.CA(DC)	DC Input Logic High	Vref + 0.100	VDD	Vref + 0.100	VDD	V	1
VIL.CA(DC)	DC Input Logic Low	VSS	Vref - 0.100	VSS	Vref - 0.100	V	1
VIH.CA(AC)	AC Input Logic High	Vref + 0.175	Note 2	Vref + 0.175	Note 2	V	1, 2
VIL.CA(AC)	AC Input Logic Low	Note 2	Vref - 0.175	Note 2	Vref - 0.175	V	1, 2
VIH.CA(AC150)	AC Input Logic High	-	-	Vref + 0.15	Note 2	V	1, 2
VIL.CA(AC150)	AC Input Logic Low	-	-	Note 2	Vref - 0.15	V	1, 2
V _{RefCA(DC)}	Reference Voltage for ADD, CMD Inputs	0.49 x VDD	0.51 x VDD	0.49 x VDD	0.51 x VDD	V	3, 4

Note:

- For input only pins except RESET. Vref = VrefCA(DC).
- See "Overshoot and Undershoot Specifications" in the device datasheet.
- The ac peak noise on VRef may not allow VRef to deviate from VRefDQ(DC) by more than +/-1% VDD (for reference: approx. +/- 15 mV).
- For reference: approx. VDD/2 +/- 15 mV.

Single-Ended AC and DC Input Levels for DQ and DM

Symbol	Parameter	DDR3-1066 (-BE)		DDR3-1333 (-CG)		Units	Note
		Min.	Max.	Min.	Max.		
VIH.DQ(DC)	DC Input Logic High	Vref + 0.100	VDD	Vref + 0.100	VDD	V	1
VIL.DQ(DC)	DC Input Logic Low	VSS	Vref - 0.100	VSS	Vref - 0.100	V	1
VIH.DQ(AC)	AC Input Logic High	Vref + 0.175	Note 2	Vref + 0.15	Note 2	V	1, 2, 5
VIL.DQ(AC)	AC Input Logic Low	Note 2	Vref - 0.175	Note 2	Vref - 0.15	V	1, 2, 5
V _{RefDQ(DC)}	Reference Voltage for DQ, DM Inputs	0.49 x VDD	0.51 x VDD	0.49 x VDD	0.51 x VDD	V	3, 4

Note:

- For input only pins except RESET. Vref = VrefDQ(DC).
- See "Overshoot and Undershoot Specifications" in the device datasheet.
- The ac peak noise on VRef may not allow VRef to deviate from VRefDQ(DC) by more than +/-1% VDD (for reference: approx. +/- 15 mV).
- For reference: approx. VDD/2 +/- 15 mV.
- Single-ended swing requirement for DQS, DQS# is 350 mV (peak to peak). Differential swing requirement for DQS - DQS# is 700 mV (peak to peak).

NT1GC72B89A0NL / NT2GC72B8PA0NL
NT4GC72B4NA1NL / NT4GC72B8NA1NL / NT8GTC72B4NA1NL
1GB: 128M x 72 / 2GB: 256M x 72 / 4GB: 512M x 72 / 8GB: 1G x 72
PC3-8500 / PC3-10600
Registered DDR3 SDRAM DIMM



Operating, Standby, and Refresh Currents

$T_{CASE} = 0\text{ }^{\circ}\text{C} \sim 85\text{ }^{\circ}\text{C}$; $V_{DDQ} = V_{DD} = 1.5\text{V} \pm 0.075\text{V}$ [1GB – 1 Rank, 128Mx8 DDR3 SDRAMs]

Symbol	Parameter/Condition	PC3-8500 (-BE)	PC3-10600 (-CG)	Unit
IDD0	Operating One Bank Active-Precharge Current	743	842	mA
IDD1	Operating One Bank Active-Read-Precharge Current	891	990	mA
IDD2P0	Precharge Power-Down Current Slow Exit	139	139	mA
IDD2P1	Precharge Power-Down Current Fast Exit	297	327	mA
IDD2Q	Precharge Quiet Standby Current	545	594	mA
IDD2N	Precharge Standby Current	446	495	mA
IDD3P	Active Power-Down Current	327	347	mA
IDD3N	Active Standby Current	545	644	mA
IDD4R	Operating Burst Read Current	1584	1980	mA
IDD4W	Operating Burst Write Current	1337	1683	mA
IDD5B	Burst Refresh Current	1782	2228	mA
IDD6	Self Refresh Current: Normal Temperature Range	119	119	mA
IDD7	Operating Bank Interleave Read Current	2178	2574	mA

Operating, Standby, and Refresh Currents

$T_{CASE} = 0\text{ }^{\circ}\text{C} \sim 85\text{ }^{\circ}\text{C}$; $V_{DDQ} = V_{DD} = 1.5\text{V} \pm 0.075\text{V}$ [2GB – 2 Ranks, 128Mx8 DDR3 SDRAMs]

Symbol	Parameter/Condition	PC3-8500 (-BE)	PC3-10600 (-CG)	Unit
IDD0	Operating One Bank Active-Precharge Current	1287	1485	mA
IDD1	Operating One Bank Active-Read-Precharge Current	1436	1634	mA
IDD2P0	Precharge Power-Down Current Slow Exit	277	277	mA
IDD2P1	Precharge Power-Down Current Fast Exit	594	653	mA
IDD2Q	Precharge Quiet Standby Current	1089	1188	mA
IDD2N	Precharge Standby Current	891	990	mA
IDD3P	Active Power-Down Current	653	693	mA
IDD3N	Active Standby Current	1089	1287	mA
IDD4R	Operating Burst Read Current	2129	2624	mA
IDD4W	Operating Burst Write Current	1881	2327	mA
IDD5B	Burst Refresh Current	2327	2871	mA
IDD6	Self Refresh Current: Normal Temperature Range	238	238	mA
IDD7	Operating Bank Interleave Read Current	2723	3218	mA

NT1GC72B89A0NL / NT2GC72B8PA0NL
NT4GC72B4NA1NL / NT4GC72B8NA1NL / NT8GTC72B4NA1NL
1GB: 128M x 72 / 2GB: 256M x 72 / 4GB: 512M x 72 / 8GB: 1G x 72
PC3-8500 / PC3-10600
Registered DDR3 SDRAM DIMM



Operating, Standby, and Refresh Currents

$T_{CASE} = 0\text{ }^{\circ}\text{C} \sim 85\text{ }^{\circ}\text{C}$; $V_{DDQ} = V_{DD} = 1.5\text{V} \pm 0.075\text{V}$ [4GB – 4 Ranks, 128Mx8 DDR3 SDRAMs]

Symbol	Parameter/Condition	PC3-8500 (-BE)	PC3-10600 (-CG)	Unit
IDD0	Operating One Bank Active-Precharge Current	2376	2772	mA
IDD1	Operating One Bank Active-Read-Precharge Current	2525	2921	mA
IDD2P0	Precharge Power-Down Current Slow Exit	554	554	mA
IDD2P1	Precharge Power-Down Current Fast Exit	1188	1307	mA
IDD2Q	Precharge Quiet Standby Current	2178	2376	mA
IDD2N	Precharge Standby Current	1782	1980	mA
IDD3P	Active Power-Down Current	1307	1386	mA
IDD3N	Active Standby Current	2178	2574	mA
IDD4R	Operating Burst Read Current	3218	3911	mA
IDD4W	Operating Burst Write Current	2970	3614	mA
IDD5B	Burst Refresh Current	3416	4158	mA
IDD6	Self Refresh Current: Normal Temperature Range	475	475	mA
IDD7	Operating Bank Interleave Read Current	3812	4505	mA

Operating, Standby, and Refresh Currents

$T_{CASE} = 0\text{ }^{\circ}\text{C} \sim 85\text{ }^{\circ}\text{C}$; $V_{DDQ} = V_{DD} = 1.5\text{V} \pm 0.075\text{V}$ [4GB – 2 Ranks, 256Mx4 DDR3 SDRAMs]

Symbol	Parameter/Condition	PC3-8500 (-BE)	PC3-10600 (-CG)	Unit
IDD0	Operating One Bank Active-Precharge Current	2574	2970	mA
IDD1	Operating One Bank Active-Read-Precharge Current	2871	3267	mA
IDD2P0	Precharge Power-Down Current Slow Exit	554	554	mA
IDD2P1	Precharge Power-Down Current Fast Exit	1188	1307	mA
IDD2Q	Precharge Quiet Standby Current	2178	2376	mA
IDD2N	Precharge Standby Current	1782	1980	mA
IDD3P	Active Power-Down Current	1307	1386	mA
IDD3N	Active Standby Current	2178	2574	mA
IDD4R	Operating Burst Read Current	4257	5247	mA
IDD4W	Operating Burst Write Current	3762	4653	mA
IDD5B	Burst Refresh Current	4653	5742	mA
IDD6	Self Refresh Current: Normal Temperature Range	475	475	mA
IDD7	Operating Bank Interleave Read Current	5049	6039	mA

NT1GC72B89A0NL / NT2GC72B8PA0NL
NT4GC72B4NA1NL / NT4GC72B8NA1NL / NT8GTC72B4NA1NL
1GB: 128M x 72 / 2GB: 256M x 72 / 4GB: 512M x 72 / 8GB: 1G x 72
PC3-8500 / PC3-10600
Registered DDR3 SDRAM DIMM



Operating, Standby, and Refresh Currents

$T_{CASE} = 0\text{ }^{\circ}\text{C} \sim 85\text{ }^{\circ}\text{C}$; $V_{DDQ} = V_{DD} = 1.5\text{V} \pm 0.075\text{V}$ [8GB – 4 Ranks, 512Mx4 (DDP) DDR3 SDRAMs]

Symbol	Parameter/Condition	PC3-8500 (-BE)	PC3-10600 (-CG)	Unit
IDD0	Operating One Bank Active-Precharge Current	4752	5544	mA
IDD1	Operating One Bank Active-Read-Precharge Current	5049	5841	mA
IDD2P0	Precharge Power-Down Current Slow Exit	1109	1109	mA
IDD2P1	Precharge Power-Down Current Fast Exit	2376	2614	mA
IDD2Q	Precharge Quiet Standby Current	4356	4752	mA
IDD2N	Precharge Standby Current	3564	3960	mA
IDD3P	Active Power-Down Current	2614	2772	mA
IDD3N	Active Standby Current	4356	5148	mA
IDD4R	Operating Burst Read Current	6435	7821	mA
IDD4W	Operating Burst Write Current	5940	7227	mA
IDD5B	Burst Refresh Current	6831	8316	mA
IDD6	Self Refresh Current: Normal Temperature Range	950	950	mA
IDD7	Operating Bank Interleave Read Current	7227	8613	mA



Speed Bins

Speed Bin			DDR3-1066 (-BE)		DDR3-1333 (-CG)		Unit
CL-nRCD-nRP			7-7-7		9-9-9		
Parameter	Symbol		min	max	min	max	
Internal read command to first data	tAA		13.125	20	13.5	20	ns
ACT to internal read or write delay	tRCD		13.125	-	13.5	-	ns
PRE command period	tRP		13.125	-	13.5	-	ns
ACT to ACT or REF command period	tRC		50.625	-	49.5	-	ns
ACT to PRE command period	tRAS		37.5	9*tREFI	36	9*tREFI	ns
CL	CWL						
6	5	tCK(avg)	2.5	3.3	2.5	3.3	ns
	6	tCK(avg)	Reserved		Reserved		ns
	7,8	tCK(avg)	Reserved		Reserved		ns
7	5	tCK(avg)	Reserved		Reserved		ns
	6	tCK(avg)	1.875	<2.5	Reserved		ns
	7,8	tCK(avg)	Reserved		Reserved		ns
8	5	tCK(avg)	Reserved		Reserved		ns
	6	tCK(avg)	1.875	<2.5	1.875	<2.5	ns
	7	tCK(avg)	Reserved		Reserved		ns
9	5,6	tCK(avg)	Reserved		Reserved		ns
	7	tCK(avg)	Reserved		1.5	<1.875	ns
	8	tCK(avg)	Reserved		Reserved		ns
Supported CL settings			6,7,8		6,8,9		nCK
Supported CWL settings			5,6		5,6,7		nCK



AC Timing Specifications for DDR3 SDRAM Devices Used on Module

Symbol	Parameter	DDR3-1066 (-BE)		DDR3-1333 (-CG)		Unit
		min	max	min	max	
Clock Timing						
tCK(DLL_OF)	Minimum Clock Cycle Time (DLL off mode)	8	-	8	-	ns
tCK(avg)	Average Clock Period(Refer to "Standard Speed					
tCH(avg)	Average high pulse width	0.47	0.53	0.47	0.53	tCK(avg)
tCL(avg)	Average low pulse width	0.47	0.53	0.47	0.53	tCK(avg)
tCK(abs)	Absolute Clock Period	tCK(avg)min + tJIT(per)min	tCK(avg)ma x + tJIT(per)ma	tCK(avg)min + tJIT(per)min	tCK(avg)ma x + tJIT(per)ma	ps
tCH(abs)	Absolute high pulse width	0.43	-	0.43	-	tCK(avg)
tCL(abs)	Absolute low pulse width	0.43	-	0.43	-	tCK(avg)
JIT(per)	Clock Period Jitter	-90	90	-80	80	ps
tJIT(per,lck)	Clock Period Jitter during DLL locking period	-80	80	-70	70	ps
tJIT(cc)	Cycle to Clcycle Period Jitter	180		160		ps
tJIT(cc,lck)	Cycle to Cycle Period Jitter	160		140		ps
tERR(2per)	Cumulative error accross 2 cycles	-132	132	-118	118	ps
tERR(3per)	Cumulative error accross 3 cycles	-157	157	-140	140	ps
tERR(4per)	Cumulative error accross 4cycles	-175	175	-155	155	ps
tERR(5per)	Cumulative error accross 5cycles	-188	188	-168	168	ps
tERR(6per)	Cumulative error accross 6 cycles	-200	200	-177	177	ps
tERR(7per)	Cumulative error accross 7 cycles	-209	209	-186	186	ps
tERR(8per)	Cumulative error accross 8 cycles	-217	217	-193	193	ps
tERR(9per)	Cumulative error accross 9 cycles	-224	224	-200	200	ps
tERR(10per)	Cumulative error accross 10 cycles	-231	231	-205	205	ps
tERR(11per)	Cumulative error accross 11 cycles	-237	237	-210	210	ps
tERR(12per)	Cumulative error accross 12 cycles	-242	242	-215	215	ps
tERR(nper)	Cumulative error accross n=13,14,...,49,50 cycles	tERR(npr)mi n = (1+ 0.68ln(n)) * tJIT(per)min	tERR(npr)m ax = (1+ 0.68ln(n)) * tJIT(per)ma	tERR(npr)mi n = (1+ 0.68ln(n)) * tJIT(per)min	tERR(npr)m ax = (1+ 0.68ln(n)) * tJIT(per)ma	ps
Data Timing						
tDQSQ	DQS, DQS to DQ skew per group, per access	-	150	-	125	ps
tQH	DQ output hold time from DQS, DQS	0.38	-	0.38	-	tCK(avg)
tLZ(DQ)	DQ low-impedance time from CK / CK	-600	300	-500	250	ps
tHZ(DQ)	DQ high-impedance time from CK / CK	-	300	-	250	ps
tDS(base)	Data Setup time to DQS, DQS referenced to Vih(ac)/ Vil(ac) levels	25		30		ps
tDH(base)	Data Hold time to DQS, DQS referenced to Vih(dc)/ Vil(dc) levels	100		65		ps
Data Strobe Timing						
tRPRE	DQS, DQS differential READ Preamble	0.9	-	0.9	-	tCK(avg)
tRPST	DQS, DQS differential READ Postamble	0.3	-	0.3	-	tCK(avg)
tQSH	DQS, DQS differential output high time	0.38	-	0.4	-	tCK(avg)
tQSL	DQS, DQS differential output low time	0.38	-	0.4	-	tCK(avg)
tWPRE	DQS, DQS differential WRITE Preamble	0.9	-	0.9	-	tCK(avg)
tWPST	DQS, DQS differential WRITE Postamble	0.3	-	0.3	-	tCK(avg)
tDQSCK	DQS, DQS rising edge output access time from rising CK, CK	-300	300	-255	255	ps
tLZ(DQS)	DQS, DQS low-impedance time (Referenced from	-600	300	-500	250	ps
tHZ(DQS)	DQS, DQS high-impedance time (Referenced from RL+BL/2)	-	300	-	250	ps
tDQSL	DQS, DQS differential input low pulse width	0.45	0.55	0.45	0.55	tCK(avg)
tDQSH	DQS, DQS differential input high pulse width	0.45	0.55	0.45	0.55	tCK(avg)
tDQSS	DQS, DQS rising edge to CK, CK rising edge	-0.25	0.25	-0.25	0.25	tCK(avg)
tDSS	DQS, DQS falling edge setup time to CK, CK rising edge	0.2	-	0.2	-	tCK(avg)
tDSH	DQS, DQS falling edge hold time to CK, CK rising	0.2	-	0.2	-	tCK(avg)

NT1GC72B89A0NL / NT2GC72B8PA0NL
NT4GC72B4NA1NL / NT4GC72B8NA1NL / NT8GTC72B4NA1NL
1GB: 128M x 72 / 2GB: 256M x 72 / 4GB: 512M x 72 / 8GB: 1G x 72
PC3-8500 / PC3-10600
Registered DDR3 SDRAM DIMM



Symbol	Parameter	DDR3-1066 (-BE)		DDR3-1333 (-CG)		Unit
		min	max	min	max	
Command and Address Timing						
tDLLK	DLL Locking time	512	-	512	-	nCK
tRTP	Internal READ command to PRECHARGE Command delay	max(4nCK, 7.5ns)	-	max(4nCK, 7.5ns)	-	
tWTR	Delay from start of internal write transaction to internal read command	max(4nCK, 7.5ns)	-	max(4nCK, 7.5ns)	-	
tWR	WRITE recovery time	15	-	15	-	ns
tMRD	Mode Register Set command cycle time	4	-	4	-	nCK
tMOD	Mode Register Set command update delay	max(12nCK, 15ns)	-	max(12nCK, 15ns)	-	
tCCD	CAS to CAS command delay	4	-	4	-	nCK
tDAL	Auto Precharge write recovery + precharge time	WR + roundup (tRP/tCK(avg))		WR + roundup (tRP/tCK(avg))		nCK
tMPRR	End of MPR Read burst to MSR for MPR (exit)	1	-	1	-	nCK
tRRD	ACTIVE to ACTIVE command period (1k page size -x4/x8)	max(4nCK, 7.5ns)	-	max(4nCK, 6ns)	-	
tRRD	ACTIVE to ACTIVE command period (2k page size -x16)	max(4nCK, 10ns)	-	max(4nCK, 7.5ns)	-	
tFAW	Four activate window (1k page size - x4/x8)	37.5	-	30	0	ns
tFAW	Four activate window (2k page size - x16)	50	-	45	0	ns
tIS(base)	Command and Address setup time to CK, CK referenced Vih(ac) / Vil(ac) levels	125	-	65	-	ps
tIH(base)	Command and Address hold time from CK, CK referenced Vih(ac) / Vil(ac) levels	200	-	140	-	ps
tIS(base) AC150	Command and Address setup time to CK, CK referenced to Vih(ac) / Vil(ac) levels	-	-	65+125	-	ps
Calibration Timing						
tZQinit	Power-up and RESET calibration time	512	-	512	-	nCK
tZQoper	Normal operation Full calibration time	256	-	256	-	nCK
tZQCS	normal operation Short calibration time	64	-	64	-	nCK
Reset Timing						
tXPR	Exit Reset from CKE HIGH to a valid command	max(5nCK, tRFC(min) +10ns)	-	max(5nCK, tRFC(min) +10ns)	-	
Self Refresh Timings						
tXS	Exit Self Refresh to Commands not requiring a locked DLL	max(5nCK, tRFC(min) +10ns)	-	max(5nCK, tRFC(min) +10ns)	-	
tXSDLL	Exit Self Refresh to Commands requiring a locked DLL	tDLLK(min)	-	tDLLK(min)	-	nCK
tCKESR	Minimum CKE low width for Self Refresh entry to exit timing	tCKE(min)+ 1nCK	-	tCKE(min)+ 1nCK	-	
tCKSRE	Valid Clock Requirement after Self Refresh Entry (SRE) or Power Down Entry (PDE)	max(5nCK, 10ns)	-	max(5nCK, 10ns)	-	
tCKSRX	Valid Clock Requirement before Self Refresh Exit(SRX) or Power-Down Exit (PDX) or Reset Exit	max(5nCK, 10ns)	-	max(5nCK, 10ns)	-	
Power Down Timings						
tXP	Exit Power Down with DLL on to any valid command; Exit Precharge Power Down with DLL frozen to commands not requiring a locked DLL	max(3nCK, 7.5ns)	-	max(3nCK, 6ns)	-	
tXPDLL	Exit Precharge Power Down with DLL frozen to commands requiring a locked DLL	max(10nCK, 24ns)	-	max(10nCK, 24ns)	-	
tCKE	CKE minimum pulse width	max(3nCK, 5.625ns)	-	max(3nCK, 5.625ns)	-	
tCPDED	Command Pass disable delay	1	-	1	-	nCK
tPD	Power Down Entry to Exit Timing	tCKE(min)	9tREFI	tCKE(min)	9tREFI	
tACTPDEN	Timing of ACT command to Power Down entry	1	-	1	-	nCK
tPRPDEN	Timing of PRE or PREA command to Power Down	1	-	1	-	nCK
tRDPDEN	Timing of RD/RDA command to Power Down entry	RL + 4 + 1	-	RL + 4 + 1	-	nCK

NT1GC72B89A0NL / NT2GC72B8PA0NL
NT4GC72B4NA1NL / NT4GC72B8NA1NL / NT8GTC72B4NA1NL
1GB: 128M x 72 / 2GB: 256M x 72 / 4GB: 512M x 72 / 8GB: 1G x 72
PC3-8500 / PC3-10600
Registered DDR3 SDRAM DIMM



Symbol	Parameter	DDR3-1066 (-BE)		DDR3-1333 (-CG)		Unit
		min	max	min	max	
tWRPDEN	Timing of WR command to Power Down entry (BL8OTF, BL8MRS, BC4OTF)	WL + 4 + (tWR/tCK(avg))	-	WL + 4 + (tWR/tCK(avg))	-	nCK
tWRAPDEN	Timing of WRA command to Power Down entry (BL8OTF, BL8MRS, BC4OTF)	WL + 4 + WR + 1	-	WL + 4 + WR + 1	-	nCK
tWRPDEN	Timing of WR command to Power Down entry (BC4MRS)	WL + 2 + (tWR/tCK(avg))	-	WL + 2 + (tWR/tCK(avg))	-	nCK
tWRAPDEN	Timing of WRA command to Power Down entry (BC4MRS)	WL + 2 + WR + 1	-	WL + 2 + WR + 1	-	nCK
tREFPDEN	Timing of REF command to Power Down entry	1	-	1	-	nCK
tMRSPDEN	Timing of MRS command to Power Down entry	tMOD(min)	-	tMOD(min)	-	
ODT Timings						
tODTH4	ODT high time without write command or with write command and BC4	4	-	4	-	nCK
tODTH8	ODT high time without write command oand BL8	6	-	6	-	nCK
tAONPD	Asynchronous RTT turn-on delay (Power-Down with DLL frozen)	1	9	1	9	ns
tAOFPD	Asynchronous RTT turn-off delay (Power Down with DLL frozen)	1	9	1	9	ns
tAON	RTT turn-on	-300	300	-250	250	ps
tAOF	RTT_NOM and RTT_WR turn-off time from ODTLoff reference	0.3	0.7	0.3	0.7	tCK(avg)
tADC	RTT dynamic change skew	0.3	0.7	0.3	0.7	tCK(avg)
Write Leveling Timings						
tWLMRD	First DQS/DQS rising edge after write leveling mode is programmed	40	-	40	-	nCK
tWLDQSEN	DQS/DQS delay after write leveling mode is	25	-	25	-	nCK
tWLS	Write leveling setup time from rising CK, CK crossing to rising DQS, DQS crossing	245	-	195	-	ps
tWLH	Write leveling hold time from rising DQS, DQS crossing to rising CK, CK crossing	245	-	195	-	ps
tWLO	Write leveling output delay	0	9	0	9	ns
tWLOE	Write levleing output error	0	2	0	2	ns
tRFC	REF command to ACT or REF command time	110		110		ns
tREFI	Average period refresh interval (0°C ≤ tCASE ≤ 85°C)	7.8		7.8		us
tREFI	Average period refresh interval (85°C < tCASE ≤ 95°C)	3.9		3.9		us

NT1GC72B89A0NL / NT2GC72B8PA0NL
NT4GC72B4NA1NL / NT4GC72B8NA1NL / NT8GTC72B4NA1NL
1GB: 128M x 72 / 2GB: 256M x 72 / 4GB: 512M x 72 / 8GB: 1G x 72
PC3-8500 / PC3-10600
Registered DDR3 SDRAM DIMM



Package Dimensions

[1GB – 1 Rank, 128Mx8 DDR3 SDRAMs]

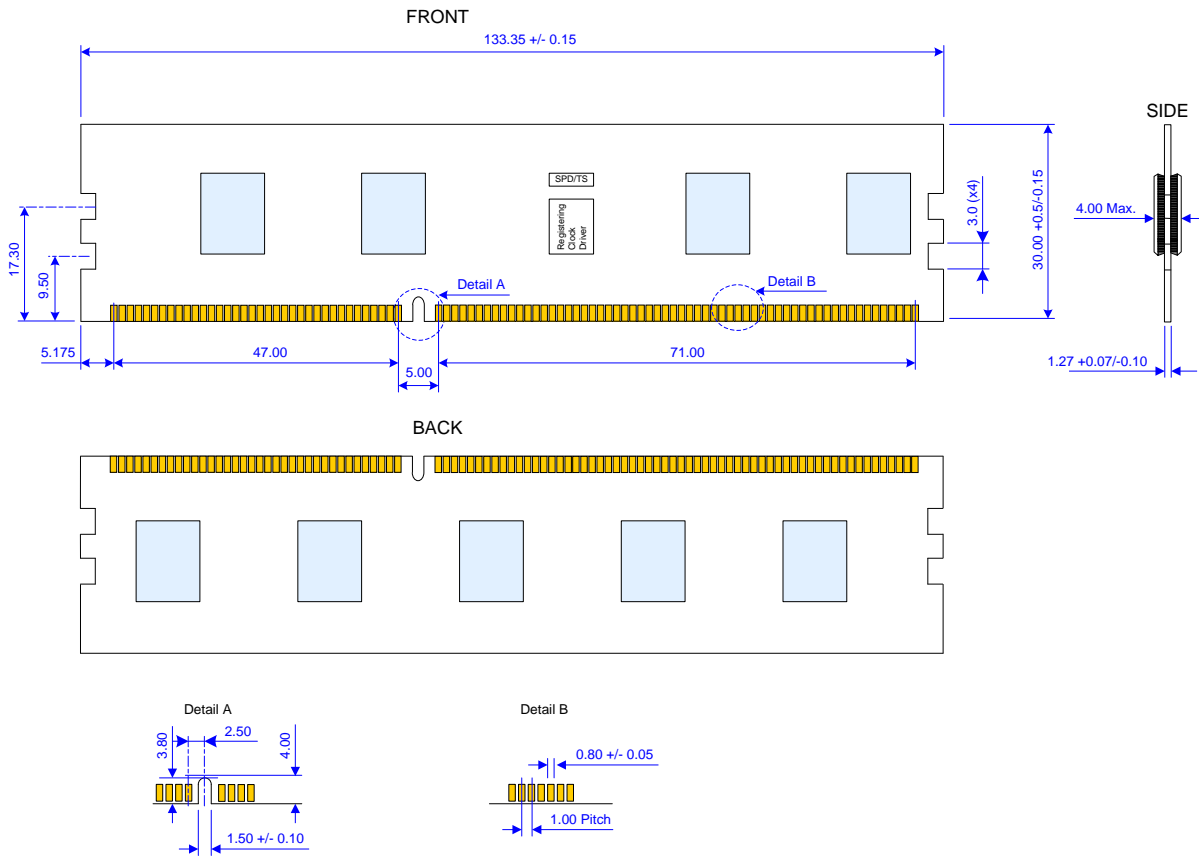

Units: Millimeters

Note: Device position and scale are only for reference.

NT1GC72B89A0NL / NT2GC72B8PA0NL
NT4GC72B4NA1NL / NT4GC72B8NA1NL / NT8GTC72B4NA1NL
1GB: 128M x 72 / 2GB: 256M x 72 / 4GB: 512M x 72 / 8GB: 1G x 72
PC3-8500 / PC3-10600
Registered DDR3 SDRAM DIMM



Package Dimensions

[2GB – 2 Ranks, 128Mx8 DDR3 SDRAMs]

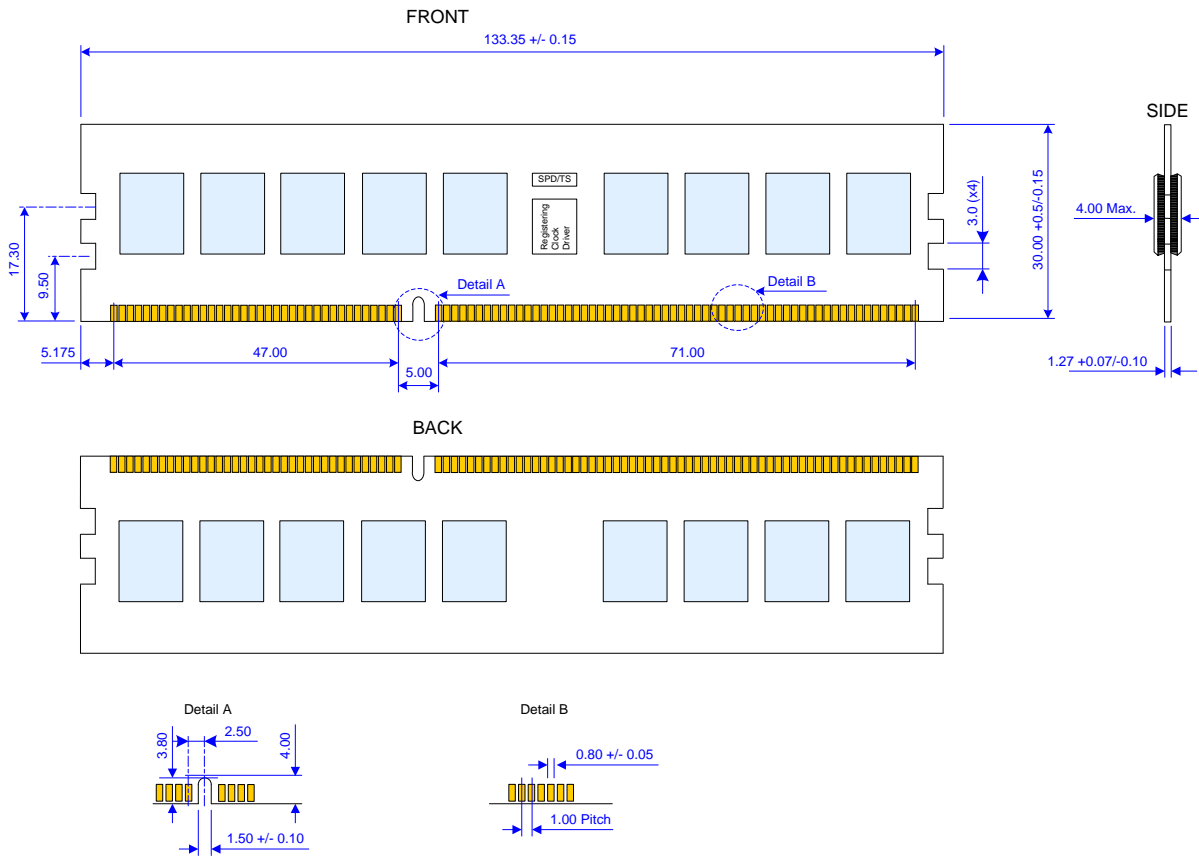

Units: Millimeters

Note: Device position and scale are only for reference.

NT1GC72B89A0NL / NT2GC72B8PA0NL
NT4GC72B4NA1NL / NT4GC72B8NA1NL / NT8GTC72B4NA1NL
1GB: 128M x 72 / 2GB: 256M x 72 / 4GB: 512M x 72 / 8GB: 1G x 72
PC3-8500 / PC3-10600
Registered DDR3 SDRAM DIMM



Package Dimensions

[4GB – 2 Ranks, 256Mx4 DDR3 SDRAMs]

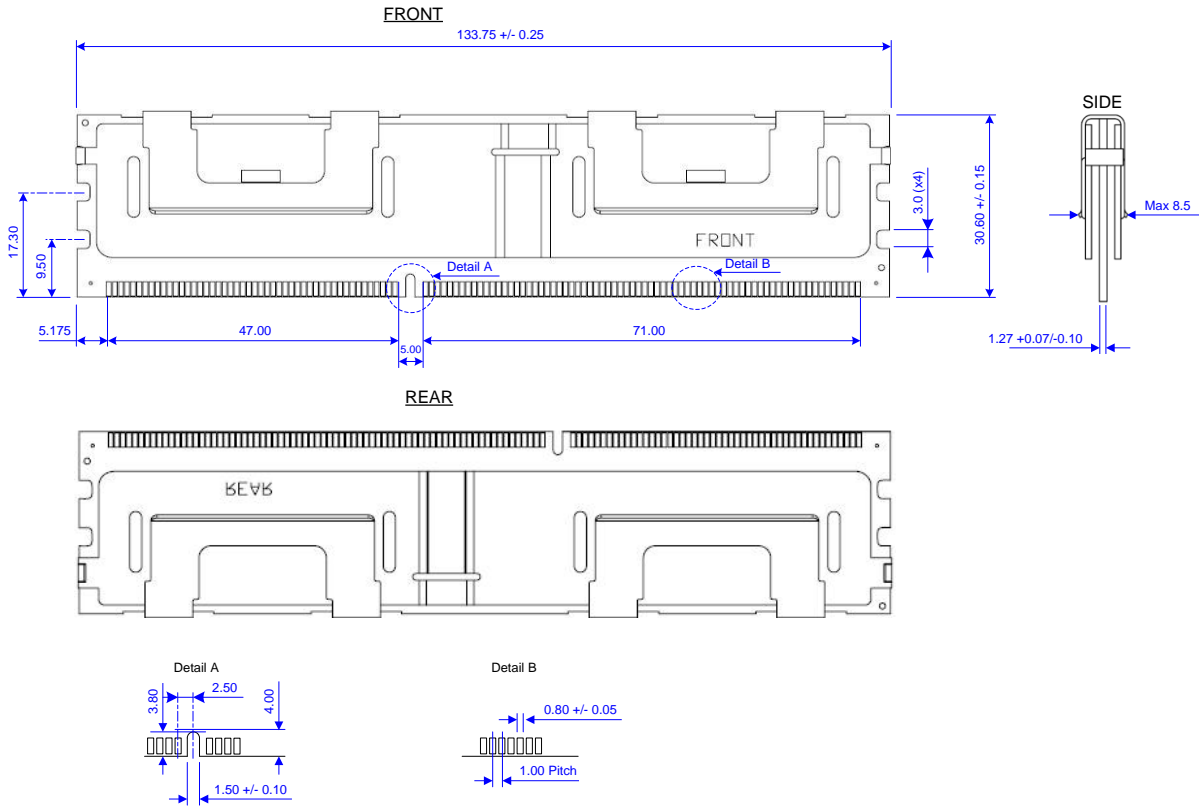

Units: Millimeters

Note: Device position and scale are only for reference.

NT1GC72B89A0NL / NT2GC72B8PA0NL
NT4GC72B4NA1NL / NT4GC72B8NA1NL / NT8GTC72B4NA1NL
1GB: 128M x 72 / 2GB: 256M x 72 / 4GB: 512M x 72 / 8GB: 1G x 72
PC3-8500 / PC3-10600
Registered DDR3 SDRAM DIMM



Package Dimensions

[4GB – 4 Ranks, 128Mx8 DDR3 SDRAMs]

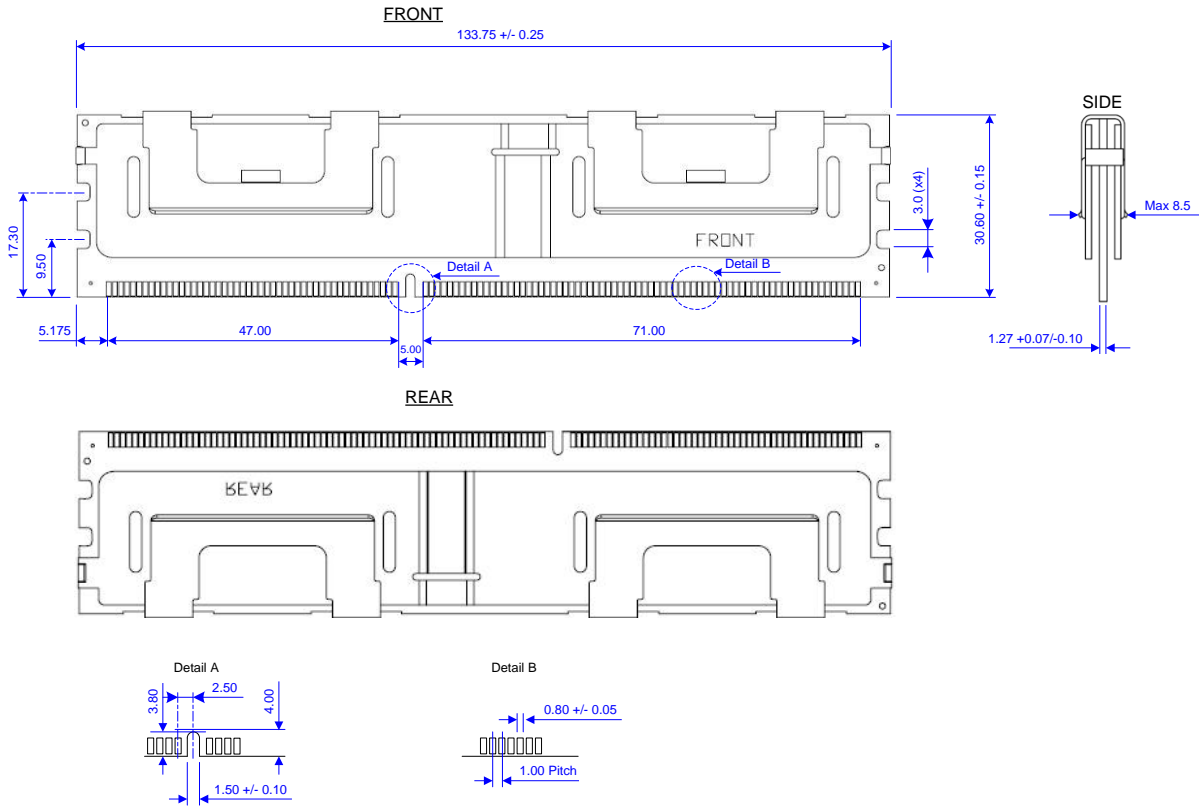

Units: Millimeters

Note: Device position and scale are only for reference.

NT1GC72B89A0NL / NT2GC72B8PA0NL
NT4GC72B4NA1NL / NT4GC72B8NA1NL / NT8GTC72B4NA1NL
1GB: 128M x 72 / 2GB: 256M x 72 / 4GB: 512M x 72 / 8GB: 1G x 72
PC3-8500 / PC3-10600
Registered DDR3 SDRAM DIMM



Package Dimensions

[8GB – 4 Ranks, 512Mx4 (DDP) DDR3 SDRAMs]

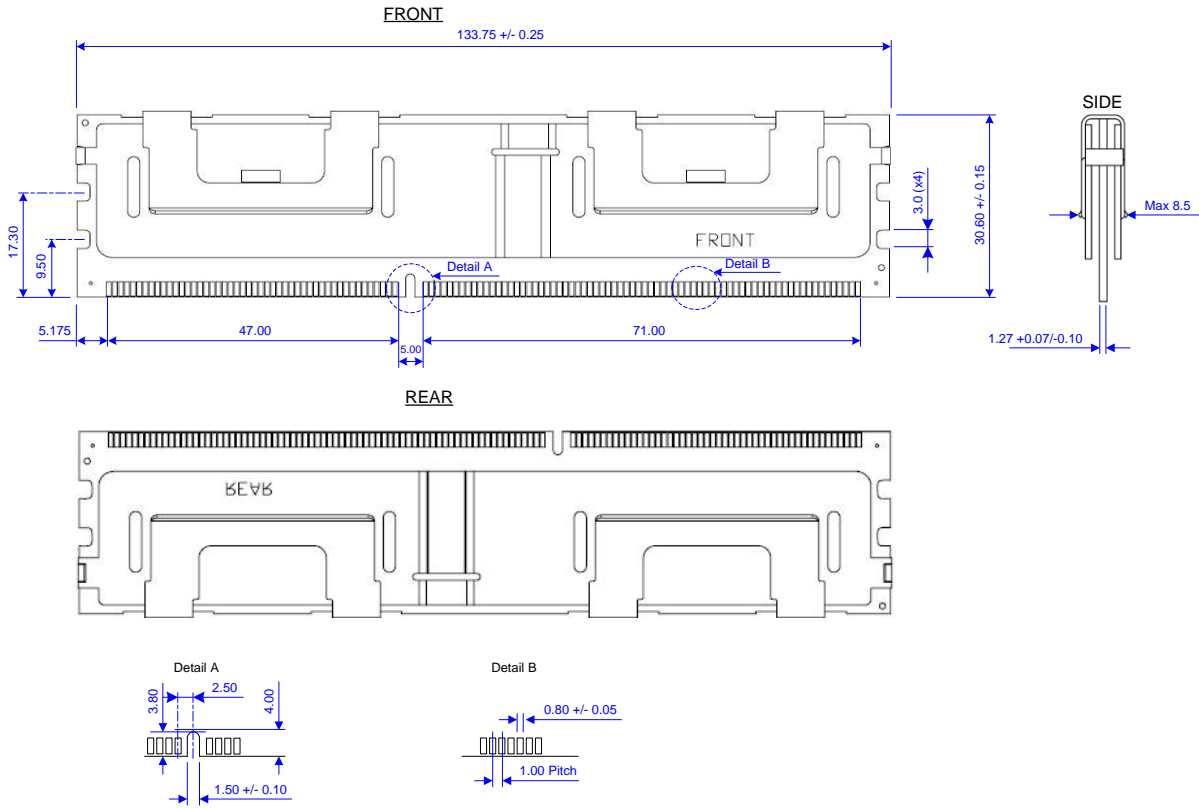

Units: Millimeters

Note: Device position and scale are only for reference.

NT1GC72B89A0NL / NT2GC72B8PA0NL
NT4GC72B4NA1NL / NT4GC72B8NA1NL / NT8GTC72B4NA1NL
1GB: 128M x 72 / 2GB: 256M x 72 / 4GB: 512M x 72 / 8GB: 1G x 72
PC3-8500 / PC3-10600
Registered DDR3 SDRAM DIMM



Revision Log

Rev	Date	Modification
0.1	07/2008	Preliminary Release
1.0	09/2008	Official Release
1.1	06/2009	4GB 4Rank x8, IDD, and SPD update

Nanya Technology Corporation

Hwa Ya Technology Park 669

Fu Hsing 3rd Rd., Kueishan,

Taoyuan, 333, Taiwan, R.O.C.

Tel: +886-3-328-1688

Please visit our home page for more information: www.nanya.com

Printed in Taiwan

©2009

REV 1.1
06/2009