

FEATURES

- *0.4 inch (10.0 mm) DIGIT HEIGHT
- *CONTINUOUS UNIFORM SEGMENTS
- *LOW POWER REQUIREMENT
- *EXCELLENT CHARACTERS APPEARANCE
- *HIGH BRIGHTNESS & HIGH CONTRAST
- *WIDE VIEWING ANGLE
- *SOLID STATE RELIABILITY
- *CATEGORIZED FOR LUMINOUS INTENSITY
- *LEAD-FREE PACKAGE

DESCRIPTION

The LTC-4627G-20 is a 0.4 inch (10.0 mm) digit height quadruple digit seven-segment display. This device utilizes green LED chips, which are made from GaP on a transparent GaP substrate, and has a gray face and white segments.

DEVICE

PART NO.	DESCRIPTION
Green	Multiplex Common Anode Rt. Hand Decimal
LTC-4627G-20	

PACKAGE DIMENSIONS

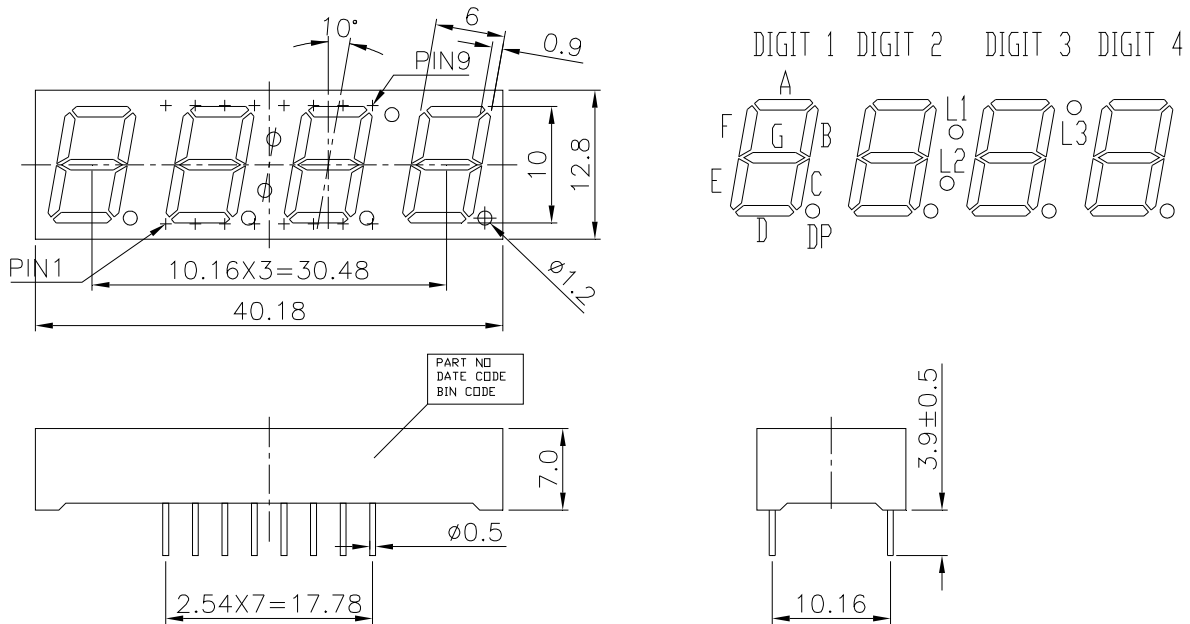

- NOTES: 1. All dimensions are in millimeters. Tolerances are ± 0.25 mm (0.01") unless otherwise noted.
 2. Pin tip's shift tolerances is ± 0.4 mm.

INTERNAL CIRCUIT DIAGRAM

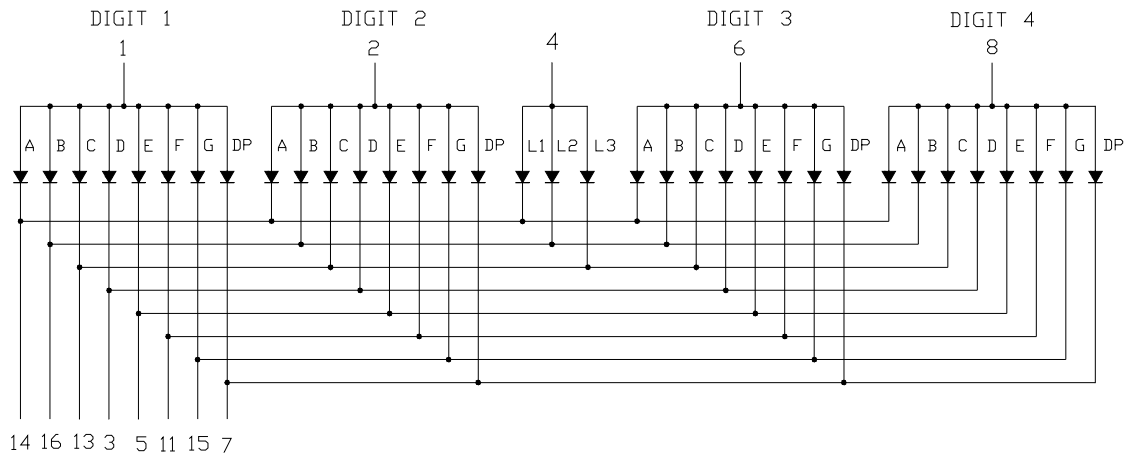

PIN CONNECTION

NO	CONNECTION
1	COMMON ANODE DIGIT 1
2	COMMON ANODE DIGIT 2
3	CATHODE D
4	COMMON ANODE L1,L2,L3
5	CATHODE E
6	COMMON ANODE DIGIT 3
7	CATHODE DP
8	COMMON ANODE DIGIT 4
9	NO CONNECTION
10	NO PIN
11	CATHODE F
12	NO PIN
13	CATHODE C,L3
14	CATHODE A,L1
15	CATHODE G
16	CATHODE B,L2

ABSOLUTE MAXIMUM RATING AT Ta=25°C

PARAMETER	MAXIMUM RATING	UNIT
Power Dissipation Per Segment	75	mW
Peak Forward Current Per Segment (Frequency 1Khz, 10% duty cycle)	100*	mA
Continuous Forward Current Per Segment	25	mA
Derating Linear From 25°C Per Segment	0.33	mA/°C
Reverse Voltage Per Segment	5	V
Operating Temperature Range	-35°C to +85°C	
Storage Temperature Range	-35°C to +85°C	
Solder Temperature: max 260°C for max 3sec at 1.6mm below seating plane.		

* see figure 5 to establish pulsed condition

ELECTRICAL / OPTICAL CHARACTERISTICS AT Ta=25°C

PARAMETER	SYMBOL	MIN.	TYP.	MAX.	UNIT	TEST CONDITION
Average Luminous Intensity	I _v	800	2200		μcd	I _F =10mA
Peak Emission Wavelength	λ _p		565		nm	I _F =20mA
Spectral Line Half-Width	Δλ		30		nm	I _F =20mA
Dominant Wavelength	λ _d		569		nm	I _F =20mA
Forward Voltage Per Segment	V _F		2.1	2.6	V	I _F =20mA
Reverse Current Per Segment	I _R			100	μA	V _R =5V
Luminous Intensity Matching Ratio (Same Light Area)	I _{v-m}			2:1		I _F =10mA

Note: Luminous intensity is measured with a light sensor and filter combination that approximates the CIE (Commision Internationale De L'Eclairage) eye-response curve.

TYPICAL ELECTRICAL / OPTICAL CHARACTERISTIC CURVES

(25°C Ambient Temperature Unless Otherwise Noted)

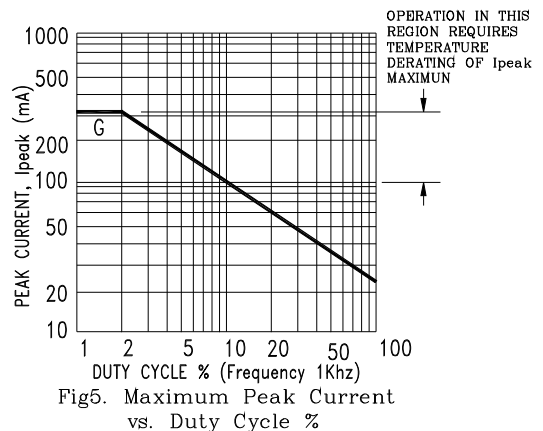
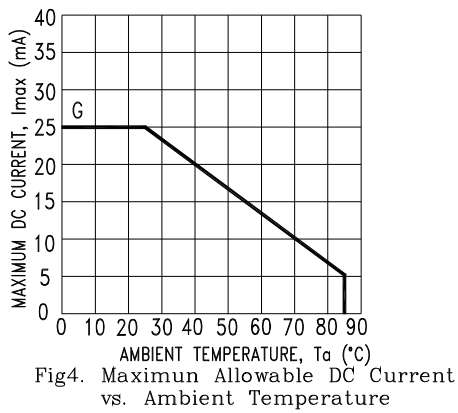
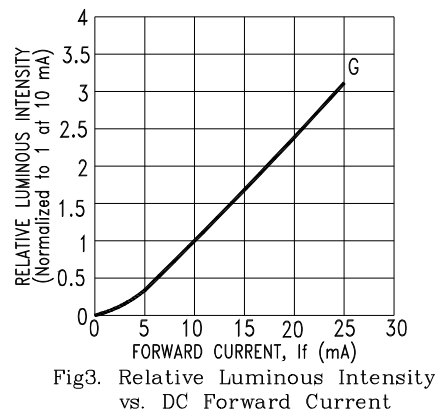
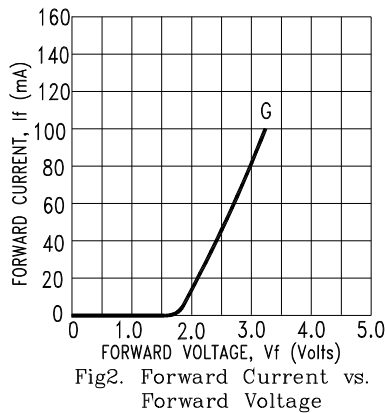
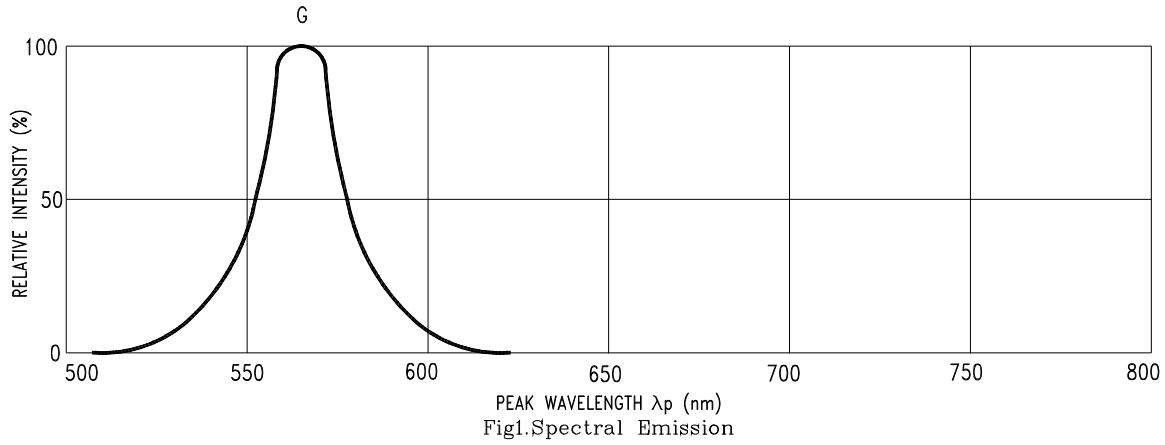

NOTE: G=GREEN.