

## FEATURES

- **2× Speed Up Version of the LTC2430: 15Hz Output Rate, 60Hz Notch—LTC2435; 13.75Hz Output Rate, Simultaneous 50Hz/60Hz Notch—LTC2435-1**
- **Differential Input and Differential Reference with GND to  $V_{CC}$  Common Mode Range**
- **3ppm INL, No Missing Codes**
- **10ppm Gain Error**
- **0.8ppm Noise**
- **Single Conversion Settling Time for Multiplexed Applications**
- **Internal Oscillator—No External Components Required**
- **Single Supply 2.7V to 5.5V Operation**
- **Low Supply Current (200 $\mu$ A, 4 $\mu$ A in Auto Sleep)**
- **20-Bit ADC in Narrow SSOP-16 Package (SO-8 Footprint)**

## APPLICATIONS

- Direct Sensor Digitizer
- Weight Scales
- Direct Temperature Measurement
- Gas Analyzers
- Strain Gage Transducers
- Instrumentation
- Data Acquisition
- Industrial Process Control
- 6-Digit DVMs

## DESCRIPTION

The LTC<sup>®</sup>2435/2435-1 are 2.7V to 5.5V micropower 20-bit differential  $\Delta\Sigma$  analog to digital converters with integrated oscillator, 3ppm INL and 0.8ppm RMS noise. They use delta-sigma technology and provide single cycle settling time for multiplexed applications. Through a single pin, the LTC2435 can be configured for better than 110dB input differential mode rejection at 50Hz or 60Hz  $\pm 2\%$ , or it can be driven by an external oscillator for a user defined rejection frequency. The LTC2435-1 can be configured for better than 87dB input differential mode rejection over the range of 49Hz to 61.2Hz (50Hz and 60Hz  $\pm 2\%$  simultaneously). The internal oscillator requires no external frequency setting components.

The converters accept any external differential reference voltage from 0.1V to  $V_{CC}$  for flexible ratiometric and remote sensing measurement configurations. The full-scale differential input range is from  $-0.5V_{REF}$  to  $0.5V_{REF}$ . The reference common mode voltage,  $V_{REFCM}$ , and the input common mode voltage,  $V_{INCM}$ , may be independently set anywhere within the GND to  $V_{CC}$  range of the LTC2435/LTC2435-1. The DC common mode input rejection is better than 120dB.

The LTC2435/LTC2435-1 communicate through a flexible 3-wire digital interface which is compatible with SPI and MICROWIRE™ protocols.

**LT**, **LT**, **LTC** and **LTM** are registered trademarks of Linear Technology Corporation. No Latency  $\Delta\Sigma$  is a trademark of Linear Technology Corporation. Protected by U.S. Patents including 6140950, 6169506.

## TYPICAL APPLICATIONS

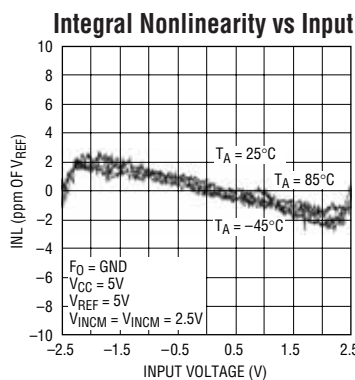
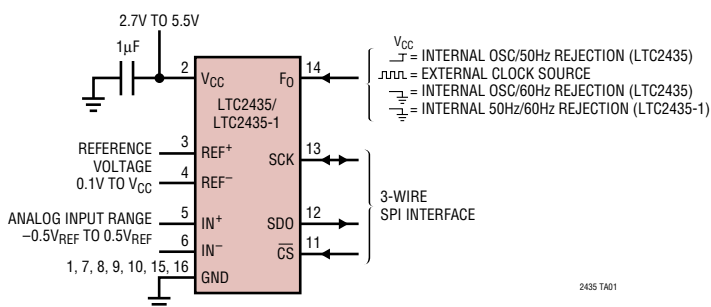

# LTC2435/LTC2435-1

## ABSOLUTE MAXIMUM RATINGS

(Notes 1, 2)

Supply Voltage ( $V_{CC}$ ) to GND .....	-0.3V to 7V
Analog Input Pins Voltage to GND ...	-0.3V to ( $V_{CC} + 0.3V$ )
Reference Input Pins Voltage to GND .....	-0.3V to ( $V_{CC} + 0.3V$ )
Digital Input Voltage to GND .....	-0.3V to ( $V_{CC} + 0.3V$ )
Digital Output Voltage to GND .....	-0.3V to ( $V_{CC} + 0.3V$ )
Operating Temperature Range	
LTC2435C/LTC2435-1C .....	0°C to 70°C
LTC2435I/LTC2435-1I .....	-40°C to 85°C
Storage Temperature Range .....	-65°C to 150°C
Lead Temperature (Soldering, 10 sec) .....	300°C

## PIN CONFIGURATION

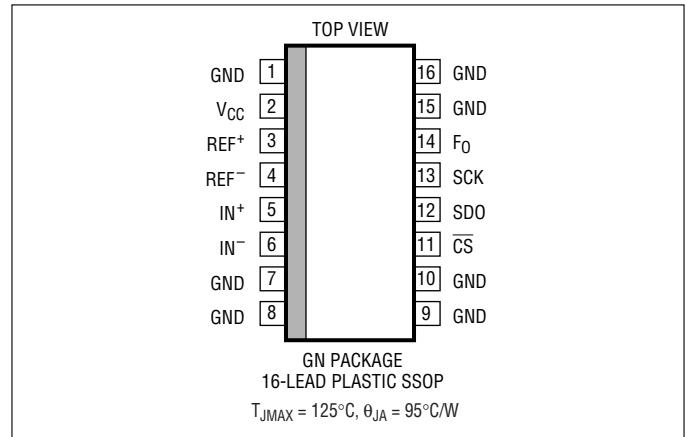

## ORDER INFORMATION

LEAD FREE FINISH	TAPE AND REEL	PART MARKING	PACKAGE DESCRIPTION	TEMPERATURE RANGE
LT2435CGN#PBF	LTC2435CGN#TRPBF	2435	16-Lead Plastic SSOP	0°C to 70°C
LT2435IGN#PBF	LTC2435CGN#TRPBF	2435I	16-Lead Plastic SSOP	-40°C to 85°C
LT2435-1CGN#PBF	LTC2435-1CGN#TRPBF	24351	16-Lead Plastic SSOP	0°C to 70°C
LT2435-1IGN#PBF	LTC2435-1IGN#TRPBF	24351I	16-Lead Plastic SSOP	-40°C to 125°C

Consult LTC Marketing for parts specified with wider operating temperature ranges.

Consult LTC Marketing for information on nonstandard lead based finish parts.

For more information on lead free part marking, go to: <http://www.linear.com/leadfree/>

For more information on tape and reel specifications, go to: <http://www.linear.com/tapeandreeel/>

## ELECTRICAL CHARACTERISTICS

The ● denotes specifications which apply over the full operating temperature range, otherwise specifications are at  $T_A = 25^\circ\text{C}$ . (Notes 3, 4)

PARAMETER	CONDITIONS	MIN	TYP	MAX	UNITS
Resolution (No Missing Codes)	$0.1V \leq V_{REF} \leq V_{CC}$ , $-0.5 \cdot V_{REF} \leq V_{IN} \leq 0.5 \cdot V_{REF}$ , (Note 5)	●	20		Bits
Integral Nonlinearity	$5V \leq V_{CC} \leq 5.5V$ , $REF^+ = 2.5V$ , $REF^- = GND$ , $V_{INCM} = 1.25V$ , (Note 6) $5V \leq V_{CC} \leq 5.5V$ , $REF^+ = 5V$ , $REF^- = GND$ , $V_{INCM} = 2.5V$ , (Note 6) $2.7V \leq V_{CC} \leq 5.5V$ , $REF^+ = 2.5V$ , $REF^- = GND$ , $V_{INCM} = 1.25V$ , (Note 6)	●	2 3 10	20	ppm of $V_{REF}$ ppm of $V_{REF}$ ppm of $V_{REF}$
Offset Error	$2.5V \leq REF^+ \leq V_{CC}$ , $REF^- = GND$ , $GND \leq IN^+ = IN^- \leq V_{CC}$ , (Note 14)	●	2	5	mV
Offset Error Drift	$2.5V \leq REF^+ \leq V_{CC}$ , $REF^- = GND$ , $GND \leq IN^+ = IN^- \leq V_{CC}$		100		nV/°C
Positive Gain Error	$2.5V \leq REF^+ \leq V_{CC}$ , $REF^- = GND$ , $IN^+ = 0.75REF^+$ , $IN^- = 0.25 \cdot REF^+$	●	10	25	ppm of $V_{REF}$
Positive Gain Error Drift	$2.5V \leq REF^+ \leq V_{CC}$ , $REF^- = GND$ , $IN^+ = 0.75REF^+$ , $IN^- = 0.25 \cdot REF^+$		0.1		ppm of $V_{REF}/^\circ\text{C}$
Negative Gain Error	$2.5V \leq REF^+ \leq V_{CC}$ , $REF^- = GND$ , $IN^+ = 0.25 \cdot REF^+$ , $IN^- = 0.75 \cdot REF^+$	●	10	25	ppm of $V_{REF}$
Negative Gain Error Drift	$2.5V \leq REF^+ \leq V_{CC}$ , $REF^- = GND$ , $IN^+ = 0.25 \cdot REF^+$ , $IN^- = 0.75 \cdot REF^+$		0.1		ppm of $V_{REF}/^\circ\text{C}$
Output Noise	$5V \leq V_{CC} \leq 5.5V$ , $REF^+ = 5V$ , $REF^- = GND$ , $GND \leq IN^- = IN^+ \leq V_{CC}$ , (Note 13)		4		$\mu\text{V}_{RMS}$

24351fb

## CONVERTER CHARACTERISTICS

The ● denotes specifications which apply over the full operating temperature range, otherwise specifications are at  $T_A = 25^\circ\text{C}$ . (Notes 3, 4)

PARAMETER	CONDITIONS		MIN	TYP	MAX	UNITS
Input Common Mode Rejection DC	$2.5\text{V} \leq \text{REF}^+ \leq V_{\text{CC}}$ , $\text{REF}^- = \text{GND}$ , $\text{GND} \leq \text{IN}^- = \text{IN}^+ \leq V_{\text{CC}}$ (Note 5)	●	110	120		dB
Input Common Mode Rejection 60Hz $\pm 2\%$ (LTC2435)	$2.5\text{V} \leq \text{REF}^+ \leq V_{\text{CC}}$ , $\text{REF}^- = \text{GND}$ , $\text{GND} \leq \text{IN}^- = \text{IN}^+ \leq V_{\text{CC}}$ , (Notes 5, 7)	●	140			dB
Input Common Mode Rejection 50Hz $\pm 2\%$ (LTC2435)	$2.5\text{V} \leq \text{REF}^+ \leq V_{\text{CC}}$ , $\text{REF}^- = \text{GND}$ , $\text{GND} \leq \text{IN}^- = \text{IN}^+ \leq V_{\text{CC}}$ , (Notes 5, 8)	●	140			dB
Input Normal Mode Rejection 60Hz $\pm 2\%$ (LTC2435)	(Notes 5, 7)	●	110	120		dB
Input Normal Mode Rejection 50Hz $\pm 2\%$ (LTC2435)	(Notes 5, 8)	●	110	120		dB
Input Common Mode Rejection 49Hz to 61.2Hz (LTC2435-1)	$2.5\text{V} \leq \text{REF}^+ \leq V_{\text{CC}}$ , $\text{REF}^- = \text{GND}$ , $\text{GND} \leq \text{IN}^- = \text{IN}^+ \leq V_{\text{CC}}$ , (Notes 5, 7)	●	120			dB
Input Normal Mode Rejection 49Hz to 61.2Hz (LTC2435-1)	$F_0 = \text{GND}$ (Note 5)	●	87			dB
Input Normal Mode Rejection External Clock $f_{\text{EOSC}}/2560 \pm 14\%$	External Oscillator (Note 5)	●	87			dB
Input Normal Mode Rejection External Clock $f_{\text{EOSC}}/2560 \pm 4\%$	External Oscillator (Note 5)	●	110	120		dB
Reference Common Mode Rejection DC	$2.5\text{V} \leq \text{REF}^+ \leq V_{\text{CC}}$ , $\text{GND} \leq \text{REF}^- \leq 2.5\text{V}$ , $V_{\text{REF}} = 2.5\text{V}$ , $\text{IN}^- = \text{IN}^+ = \text{GND}$ (Note 5)	●	130	140		dB
Power Supply Rejection, DC	$\text{REF}^+ = V_{\text{CC}}$ , $\text{REF}^- = \text{GND}$ , $\text{IN}^- = \text{IN}^+ = \text{GND}$			100		dB
Power Supply Rejection, 60Hz $\pm 2\%$	$\text{REF}^+ = 2.5\text{V}$ , $\text{REF}^- = \text{GND}$ , $\text{IN}^- = \text{IN}^+ = \text{GND}$ , (Note 7)			120		dB
Power Supply Rejection, 50Hz $\pm 2\%$	$\text{REF}^+ = 2.5\text{V}$ , $\text{REF}^- = \text{GND}$ , $\text{IN}^- = \text{IN}^+ = \text{GND}$ , (Note 8)			120		dB

## ANALOG INPUT AND REFERENCE

The ● denotes specifications which apply over the full operating temperature range, otherwise specifications are at  $T_A = 25^\circ\text{C}$ . (Note 3)

SYMBOL	PARAMETER	CONDITIONS		MIN	TYP	MAX	UNITS
$\text{IN}^+$	Absolute/Common Mode $\text{IN}^+$ Voltage		●	$\text{GND} - 0.3\text{V}$		$V_{\text{CC}} + 0.3\text{V}$	V
$\text{IN}^-$	Absolute/Common Mode $\text{IN}^-$ Voltage		●	$\text{GND} - 0.3\text{V}$		$V_{\text{CC}} + 0.3\text{V}$	V
$V_{\text{IN}}$	Input Differential Voltage Range ( $\text{IN}^+ - \text{IN}^-$ )		●	$-V_{\text{REF}}/2$		$V_{\text{REF}}/2$	V
$\text{REF}^+$	Absolute/Common Mode $\text{REF}^+$ Voltage		●	0.1		$V_{\text{CC}}$	V
$\text{REF}^-$	Absolute/Common Mode $\text{REF}^-$ Voltage		●	$\text{GND}$		$V_{\text{CC}} - 0.1\text{V}$	V
$V_{\text{REF}}$	Reference Differential Voltage Range ( $\text{REF}^+ - \text{REF}^-$ )		●	0.1		$V_{\text{CC}}$	V
$C_S (\text{IN}^+)$	$\text{IN}^+$ Sampling Capacitance				1.5		pF
$C_S (\text{IN}^-)$	$\text{IN}^-$ Sampling Capacitance				1.5		pF
$C_S (\text{REF}^+)$	$\text{REF}^+$ Sampling Capacitance				1.5		pF
$C_S (\text{REF}^-)$	$\text{REF}^-$ Sampling Capacitance				1.5		pF
$I_{\text{DC\_LEAK}} (\text{IN}^+)$	$\text{IN}^+$ DC Leakage Current	$\overline{\text{CS}} = V_{\text{CC}}$ , $\text{IN}^+ = \text{GND}$	●	-10	1	10	nA
$I_{\text{DC\_LEAK}} (\text{IN}^-)$	$\text{IN}^-$ DC Leakage Current	$\overline{\text{CS}} = V_{\text{CC}}$ , $\text{IN}^- = V_{\text{CC}}$	●	-10	1	10	nA
$I_{\text{DC\_LEAK}} (\text{REF}^+)$	$\text{REF}^+$ DC Leakage Current	$\overline{\text{CS}} = V_{\text{CC}}$ , $\text{REF}^+ = V_{\text{CC}}$	●	-10	1	10	nA
$I_{\text{DC\_LEAK}} (\text{REF}^-)$	$\text{REF}^-$ DC Leakage Current	$\overline{\text{CS}} = V_{\text{CC}}$ , $\text{REF}^- = \text{GND}$	●	-10	1	10	nA

## DIGITAL INPUTS AND DIGITAL OUTPUTS

The ● denotes specifications which apply over the full operating temperature range, otherwise specifications are at  $T_A = 25^\circ\text{C}$ . (Note 3)

SYMBOL	PARAMETER	CONDITIONS	MIN	TYP	MAX	UNITS
$V_{IH}$	High Level Input Voltage $\overline{CS}$ , $F_0$	$2.7V \leq V_{CC} \leq 5.5V$	2.5			V
		$2.7V \leq V_{CC} \leq 3.3V$	2.0			V
$V_{IL}$	Low Level Input Voltage $\overline{CS}$ , $F_0$	$4.5V \leq V_{CC} \leq 5.5V$			0.8	V
		$2.7V \leq V_{CC} \leq 5.5V$			0.6	V
$V_{IH}$	High Level Input Voltage SCK	$2.7V \leq V_{CC} \leq 5.5V$ (Note 9)	2.5			V
		$2.7V \leq V_{CC} \leq 3.3V$ (Note 9)	2.0			V
$V_{IL}$	Low Level Input Voltage SCK	$4.5V \leq V_{CC} \leq 5.5V$ (Note 9)			0.8	V
		$2.7V \leq V_{CC} \leq 5.5V$ (Note 9)			0.6	V
$I_{IN}$	Digital Input Current $\overline{CS}$ , $F_0$	$0V \leq V_{IN} \leq V_{CC}$	-10		10	$\mu\text{A}$
$I_{IN}$	Digital Input Current SCK	$0V \leq V_{IN} \leq V_{CC}$ (Note 9)	-10		10	$\mu\text{A}$
$C_{IN}$	Digital Input Capacitance $\overline{CS}$ , $F_0$			10		pF
$C_{IN}$	Digital Input Capacitance SCK	(Note 9)		10		pF
$V_{OH}$	High Level Output Voltage SDO	$I_O = -800\mu\text{A}$	$V_{CC} - 0.5$			V
$V_{OL}$	Low Level Output Voltage SDO	$I_O = 1.6\text{mA}$			0.4	V
$V_{OH}$	High Level Output Voltage SCK	$I_O = -800\mu\text{A}$ (Note 10)	$V_{CC} - 0.5$			V
$V_{OL}$	Low Level Output Voltage SCK	$I_O = 1.6\text{mA}$ (Note 10)			0.4	V
$I_{OZ}$	Hi-Z Output Leakage SDO		-10		10	$\mu\text{A}$

## POWER REQUIREMENTS

The ● denotes specifications which apply over the full operating temperature range, otherwise specifications are at  $T_A = 25^\circ\text{C}$ . (Note 3)

SYMBOL	PARAMETER	CONDITIONS	MIN	TYP	MAX	UNITS
$V_{CC}$	Supply Voltage		2.7		5.5	V
$I_{CC}$	Supply Current					
	Conversion Mode	$\overline{CS} = 0V$ (Note 12)		200	300	$\mu\text{A}$
	Sleep Mode	$\overline{CS} = V_{CC}$ (Note 12)		4	10	$\mu\text{A}$
	Sleep Mode	$\overline{CS} = V_{CC}$ , $2.7V \leq V_{CC} \leq 3.3V$ (Note 12)		2		$\mu\text{A}$

## TIMING CHARACTERISTICS

The ● denotes specifications which apply over the full operating temperature range, otherwise specifications are at  $T_A = 25^\circ\text{C}$ . (Note 3)

SYMBOL	PARAMETER	CONDITIONS	MIN	TYP	MAX	UNITS	
$f_{\text{EOSC}}$	External Oscillator Frequency Range		●	5	2000	kHz	
$t_{\text{HEO}}$	External Oscillator High Period		●	0.25	200	$\mu\text{s}$	
$t_{\text{LEO}}$	External Oscillator Low Period		●	0.25	200	$\mu\text{s}$	
$t_{\text{CONV}}$	Conversion Time (LTC2435)	$F_0 = 0\text{V}$	●	65.6	66.9	68.3	ms
		$F_0 = V_{\text{CC}}$	●	78.7	80.3	81.9	ms
		External Oscillator (Note 11)	●	10278/ $f_{\text{EOSC}}$ (in kHz)			ms
$t_{\text{CONV}}$	Conversion Time (LTC2435-1)	$F_0 = 0\text{V}$	●	72	73.5	75	ms
		External Oscillator (Note 11)	●	10278/ $f_{\text{EOSC}}$ (in kHz)			ms
$f_{\text{ISCK}}$	Internal SCK Frequency	Internal Oscillator (Note 10), LTC2435		19.2		kHz	
		Internal Oscillator (Note 10), LTC2435-1		17.5		kHz	
		External Oscillator (Notes 10, 11)		$f_{\text{EOSC}}/8$		kHz	
$D_{\text{ISCK}}$	Internal SCK Duty Cycle	(Note 10)	●	45	55	%	
$f_{\text{ESCK}}$	External SCK Frequency Range	(Note 9)	●		2000	kHz	
$t_{\text{LESCK}}$	External SCK Low Period	(Note 9)	●	250		ns	
$t_{\text{HESCK}}$	External SCK High Period	(Note 9)	●	250		ns	
$t_{\text{DOUT\_ISCK}}$	Internal SCK 24-Bit Data Output Time	Internal Oscillator (Notes 10, 12), LTC2435	●	1.22	1.25	1.28	ms
		Internal Oscillator (Notes 10, 12), LTC2435-1	●	1.34	1.37	1.40	ms
		External Oscillator (Notes 10, 11)	●	192/ $f_{\text{EOSC}}$ (in kHz)			ms
$t_{\text{DOUT\_ESCK}}$	External SCK 24-Bit Data Output Time	(Note 9)	●	24/ $f_{\text{ESCK}}$ (in kHz)		ms	
$t_1$	$\overline{\text{CS}} \downarrow$ to SDO Low Z		●	0	200	ns	
$t_2$	$\overline{\text{CS}} \uparrow$ to SDO High Z		●	0	200	ns	
$t_3$	$\overline{\text{CS}} \downarrow$ to SCK $\downarrow$	(Note 10)	●	0	200	ns	
$t_4$	$\overline{\text{CS}} \downarrow$ to SCK $\uparrow$	(Note 9)	●	50		ns	
$t_{\text{KQMAX}}$	SCK $\downarrow$ to SDO Valid		●		220	ns	
$t_{\text{KQMIN}}$	SDO Hold After SCK $\downarrow$	(Note 5)	●	15		ns	
$t_5$	SCK Set-Up Before $\overline{\text{CS}} \downarrow$		●	50		ns	
$t_6$	SCK Hold After $\overline{\text{CS}} \downarrow$		●		50	ns	

**Note 1:** Stresses beyond those listed under Absolute Maximum Ratings may cause permanent damage to the device. Exposure to any Absolute Maximum Rating condition for extended periods may affect device reliability and lifetime.

**Note 2:** All voltage values are with respect to GND.

**Note 3:**  $V_{\text{CC}} = 2.7$  to  $5.5\text{V}$  unless otherwise specified.  
 $V_{\text{REF}} = \text{REF}^+ - \text{REF}^-$ ,  $V_{\text{REFCM}} = (\text{REF}^+ + \text{REF}^-)/2$ ;  
 $V_{\text{IN}} = \text{IN}^+ - \text{IN}^-$ ,  $V_{\text{INCM}} = (\text{IN}^+ + \text{IN}^-)/2$ .

**Note 4:**  $F_0$  pin tied to GND or to  $V_{\text{CC}}$  or to external conversion clock source with  $f_{\text{EOSC}} = 153600\text{Hz}$  unless otherwise specified.

**Note 5:** Guaranteed by design, not subject to test.

**Note 6:** Integral nonlinearity is defined as the deviation of a code from a straight line passing through the actual endpoints of the transfer curve. The deviation is measured from the center of the quantization band.

**Note 7:**  $F_0 = 0\text{V}$  (internal oscillator) or  $f_{\text{EOSC}} = 153600\text{Hz} \pm 2\%$  (external oscillator) for the LTC2435 or  $f_{\text{EOSC}} = 139800\text{Hz} \pm 2\%$  for the LTC2435-1.

**Note 8:**  $F_0 = V_{\text{CC}}$  (internal oscillator) or  $f_{\text{EOSC}} = 128000\text{Hz} \pm 2\%$  (external oscillator).

**Note 9:** The converter is in external SCK mode of operation such that the SCK pin is used as digital input. The frequency of the clock signal driving SCK during the data output is  $f_{\text{ESCK}}$  and is expressed in kHz.

**Note 10:** The converter is in internal SCK mode of operation such that the SCK pin is used as digital output. In this mode of operation the SCK pin has a total equivalent load capacitance  $C_{\text{LOAD}} = 20\text{pF}$ .

**Note 11:** The external oscillator is connected to the  $F_0$  pin. The external oscillator frequency,  $f_{\text{EOSC}}$ , is expressed in kHz.

**Note 12:** The converter uses the internal oscillator.

$F_0 = 0\text{V}$  or  $F_0 = V_{\text{CC}}$ .

**Note 13:** The output noise includes the contribution of the internal calibration operations.

**Note 14:** Refer to Offset Accuracy and Drift in the Applications Information section.

## TYPICAL PERFORMANCE CHARACTERISTICS

**Total Unadjusted Error ( $V_{CC} = 5V$ ,  $V_{REF} = 5V$ )**

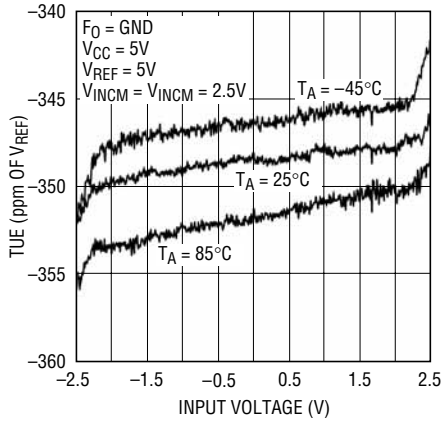

2435 G01

**Total Unadjusted Error ( $V_{CC} = 5V$ ,  $V_{REF} = 2.5V$ )**

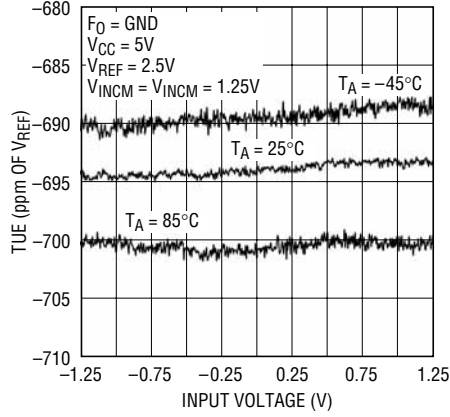

2435 G02

**Total Unadjusted Error ( $V_{CC} = 2.7V$ ,  $V_{REF} = 2.5V$ )**

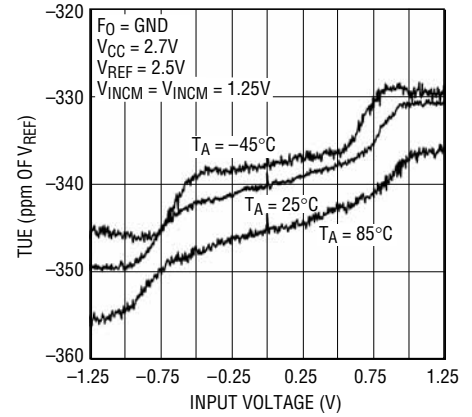

2435 G03

**Integral Nonlinearity ( $V_{CC} = 5V$ ,  $V_{REF} = 5V$ )**

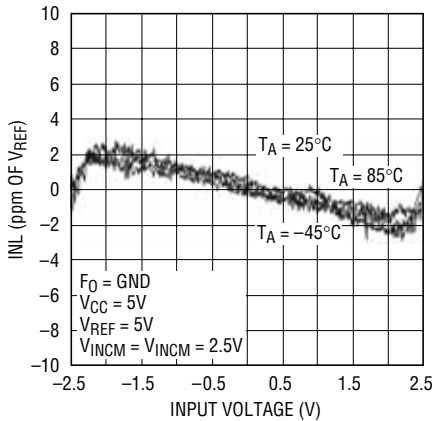

2435 G04

**Integral Nonlinearity ( $V_{CC} = 5V$ ,  $V_{REF} = 2.5V$ )**

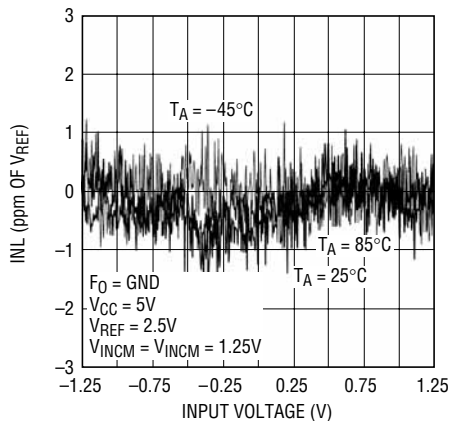

2435 G05

**Integral Nonlinearity ( $V_{CC} = 2.7V$ ,  $V_{REF} = 2.5V$ )**

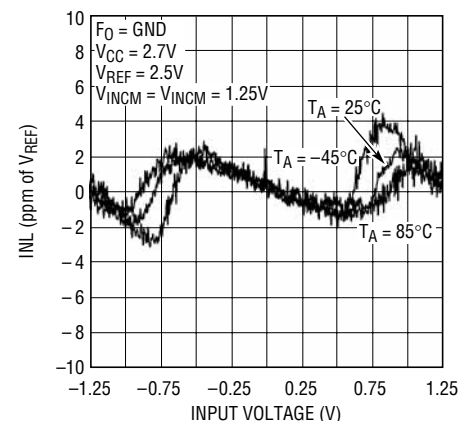

2435 G06

**Noise Histogram (Output Rate = 15Hz,  $V_{CC} = 5V$ ,  $V_{REF} = 5V$ )**

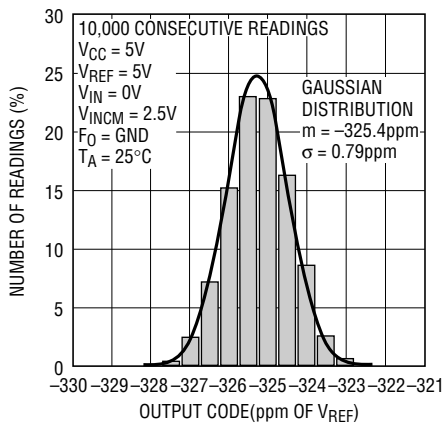

2435 G07

**Noise Histogram (Output Rate = 15Hz,  $V_{CC} = 2.7V$ ,  $V_{REF} = 2.5V$ )**

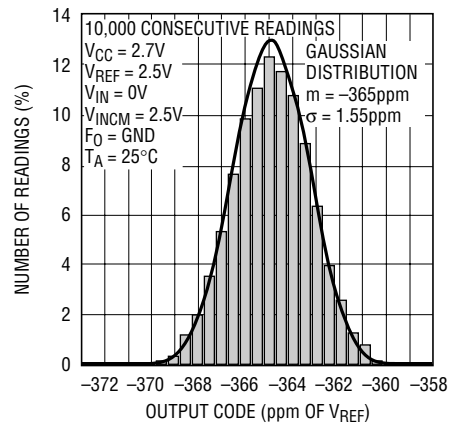

2435 G08

# TYPICAL PERFORMANCE CHARACTERISTICS

**RMS Noise vs Input Differential Voltage**

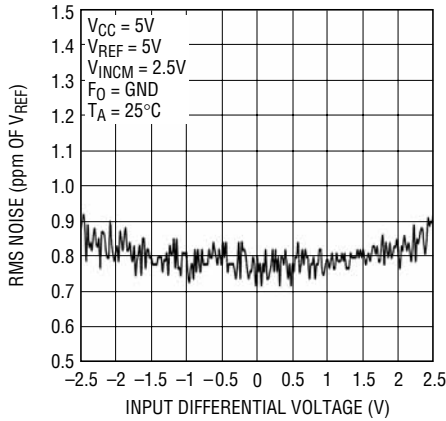

2435 G10

**RMS Noise vs  $V_{INCM}$**

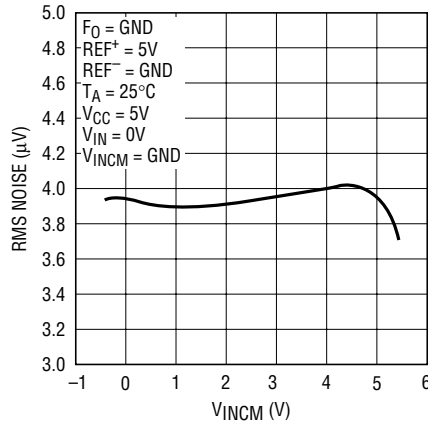

2435 G11

**RMS Noise vs Temperature ( $T_A$ )**

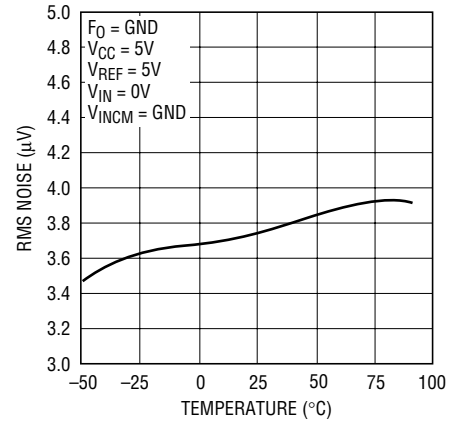

2435 G12

**RMS Noise vs  $V_{CC} = V_{REF}$**

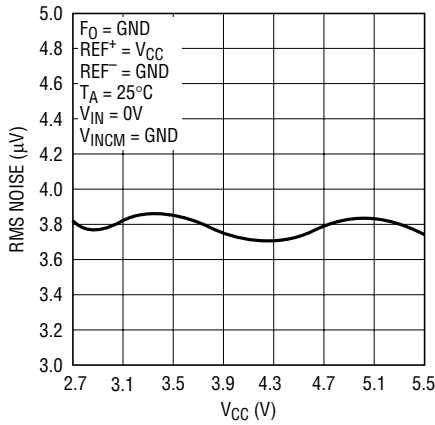

2435 G13

**RMS Noise vs  $V_{REF}$**

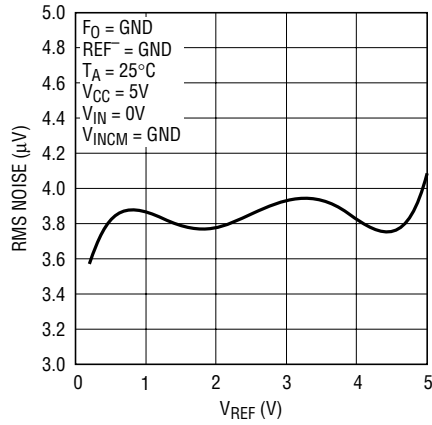

2435 G14

**Offset Error vs  $V_{INCM}$**

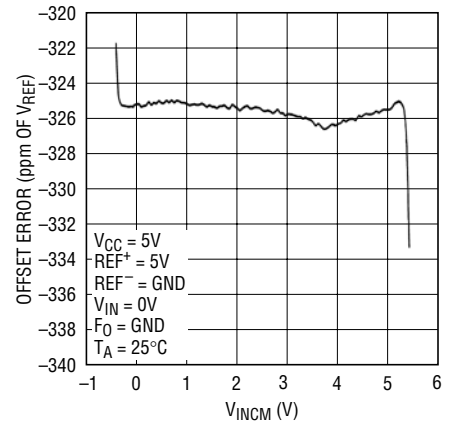

2435 G15

**Offset Error vs Temperature**

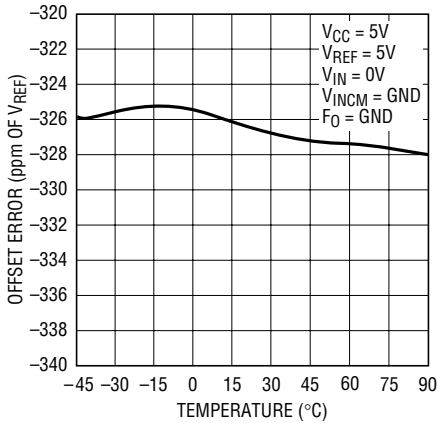

2435 G16

**Offset Error vs  $V_{CC} = V_{REF}$**

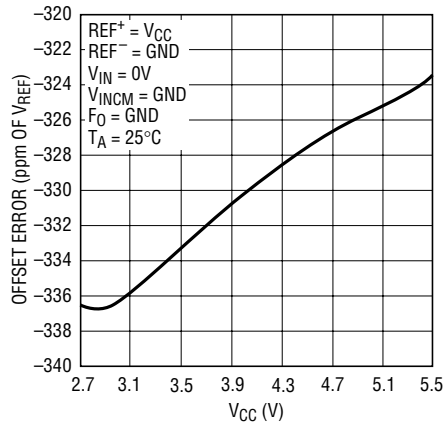

2435 G17

**Offset Error vs  $V_{REF}$**

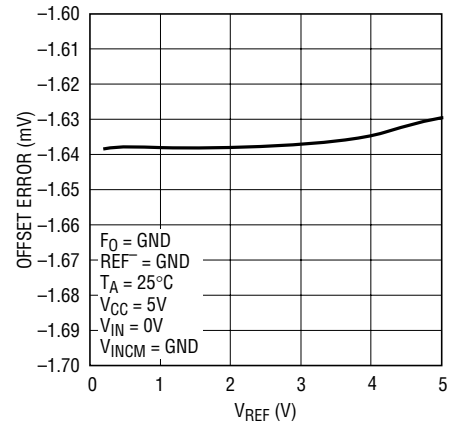

2435 G18



## TYPICAL PERFORMANCE CHARACTERISTICS

**Full-Scale Error vs Temperature**

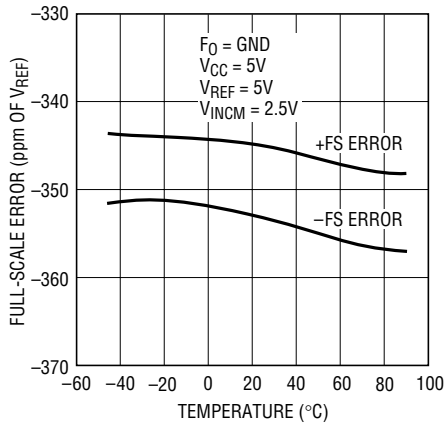

2435 G19

**Full-Scale Error vs  $V_{CC}$**

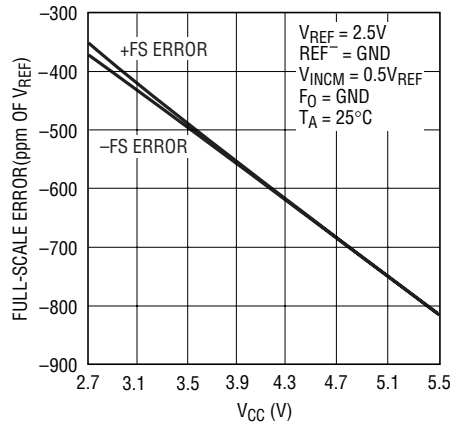

2435 G20

**+Full-Scale Gain Error vs  $V_{CC}$**

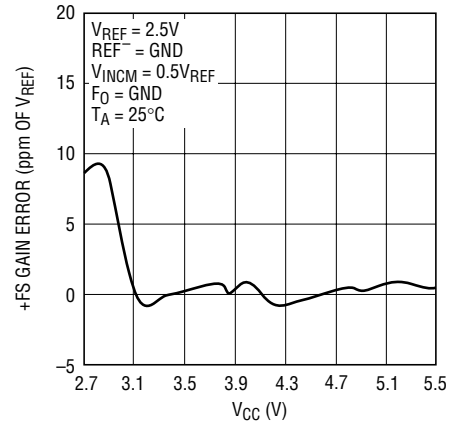

2435 G21

**PSRR vs Frequency at  $V_{CC}$  (LTC2435-1)**

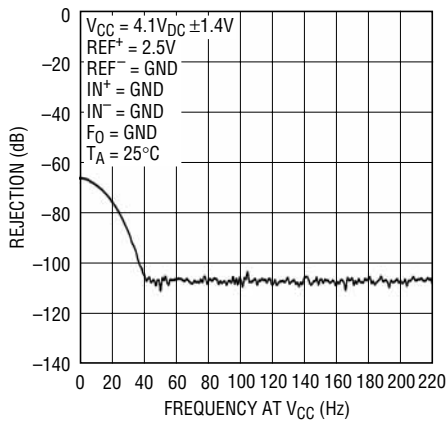

2435 G22

**PSRR vs Frequency at  $V_{CC}$  (LTC2435-1)**

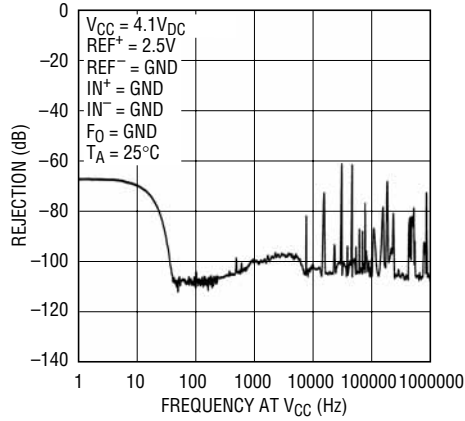

2435 G23

**PSRR vs Frequency at  $V_{CC}$  (LTC2435-1)**

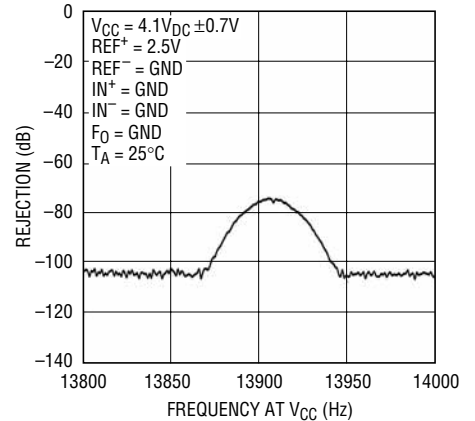

2435 G24

**PSRR vs Frequency at  $V_{CC}$  (LTC2435)**

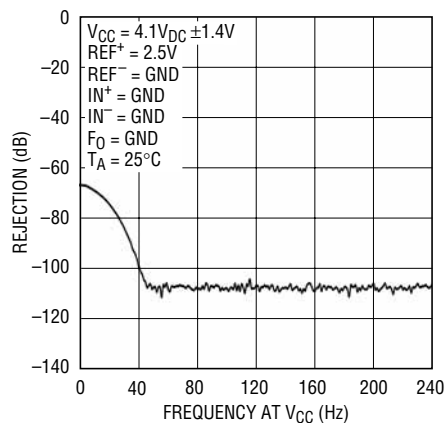

2435 G25

**PSRR vs Frequency at  $V_{CC}$  (LTC2435)**

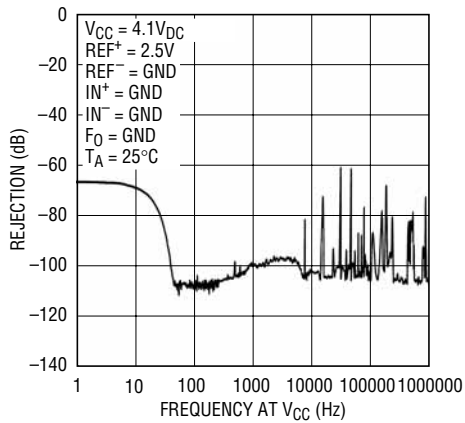

2435 G26

**PSRR vs Frequency at  $V_{CC}$  (LTC2435)**

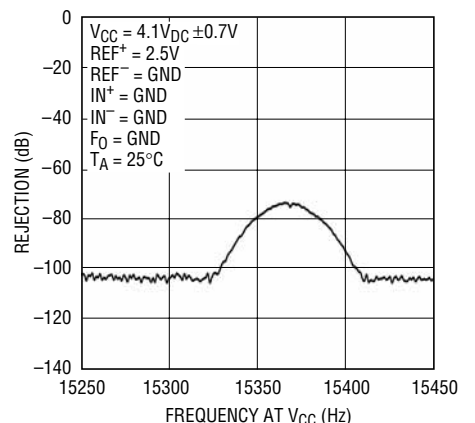

2435 G27

24351fb



# TYPICAL PERFORMANCE CHARACTERISTICS

**Conversion Current vs Temperature**

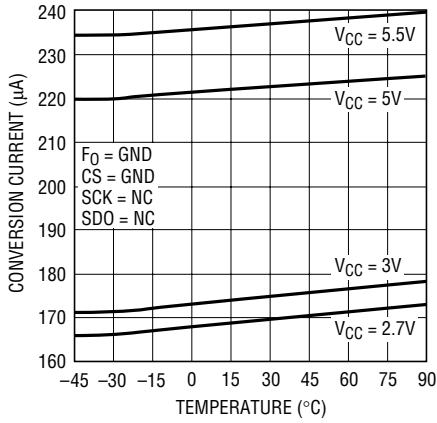

2435 G28

**Conversion Current vs Output Data Rate**

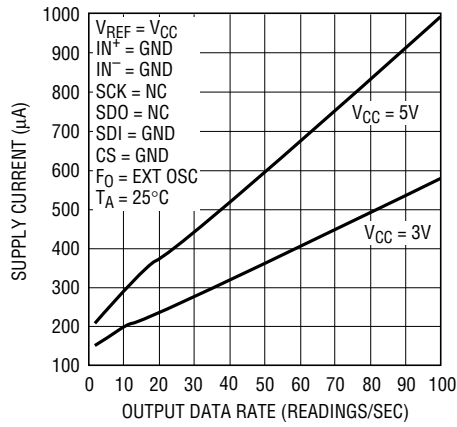

2435 G29

**Sleep-Mode Current vs Temperature**

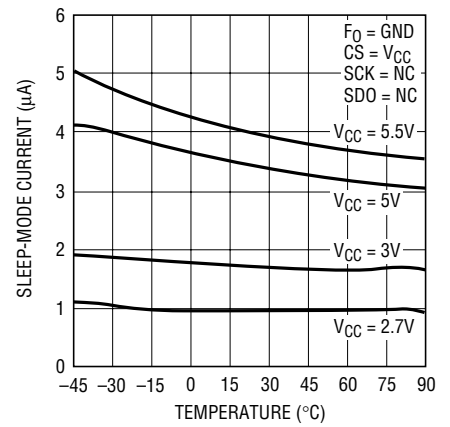

2435 G30

**Offset Change\* vs Output Data Rate**

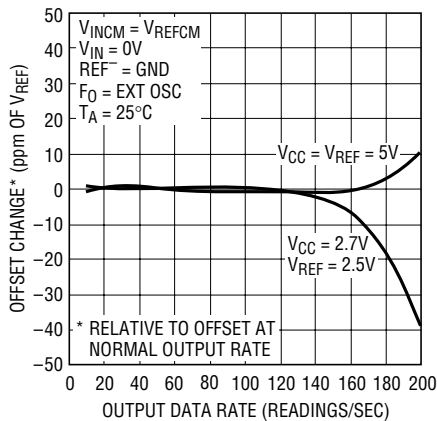

2435 G31

**Resolution (Noise<sub>RMS</sub> ≤ 1LSB) vs Output Data Rate**

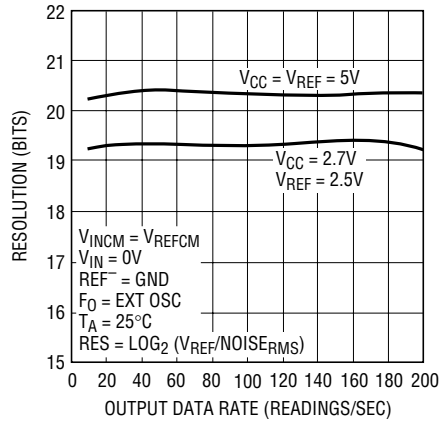

2435 G32

**Resolution (INL<sub>MAX</sub> ≤ 1LSB) vs Output Data Rate**

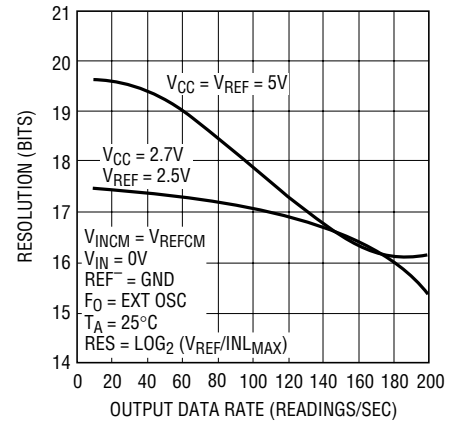

2435 G33

## PIN FUNCTIONS

**GND (Pins 1, 7, 8, 9, 10, 15, 16):** Ground. Multiple ground pins internally connected for optimum ground current flow and  $V_{CC}$  decoupling. Connect each one of these pins to a ground plane through a low impedance connection. All seven pins must be connected to ground for proper operation.

**$V_{CC}$  (Pin 2):** Positive Supply Voltage. Bypass to GND (Pin 1) with a 10 $\mu$ F tantalum capacitor in parallel with 0.1 $\mu$ F ceramic capacitor as close to the part as possible.

**REF<sup>+</sup> (Pin 3), REF<sup>-</sup> (Pin 4):** Differential Reference Input. The voltage on these pins can have any value between GND and  $V_{CC}$  as long as the reference positive input, REF<sup>+</sup>, is maintained more positive than the reference negative input, REF<sup>-</sup>, by at least 0.1V.

**IN<sup>+</sup> (Pin 5), IN<sup>-</sup> (Pin 6):** Differential Analog Input. The voltage on these pins can have any value between GND - 0.3V and  $V_{CC}$  + 0.3V. Within these limits the converter bipolar input range ( $V_{IN} = IN^+ - IN^-$ ) extends from  $-0.5 \cdot (V_{REF})$  to  $0.5 \cdot (V_{REF})$ . Outside this input range the converter produces unique overrange and underrange output codes.

**$\overline{CS}$  (Pin 11):** Active LOW Digital Input. A LOW on this pin enables the SDO digital output and wakes up the ADC. Following each conversion, the ADC automatically enters the Sleep mode and remains in this low power state as long as  $\overline{CS}$  is HIGH. A LOW-to-HIGH transition on  $\overline{CS}$  during the Data Output transfer aborts the data transfer and starts a new conversion.

**SDO (Pin 12):** Three-State Digital Output. During the Data Output period, this pin is used as serial data output. When the chip select  $\overline{CS}$  is HIGH ( $\overline{CS} = V_{CC}$ ) the SDO pin is in a high impedance state. During the Conversion and Sleep periods, this pin is used as the conversion status output. The conversion status can be observed by pulling  $\overline{CS}$  LOW.

**SCK (Pin 13):** Bidirectional Digital Clock Pin. In Internal Serial Clock Operation mode, SCK is used as digital output for the internal serial interface clock during the Data Output period. In External Serial Clock Operation mode, SCK is used as digital input for the external serial interface clock during the Data Output period. A weak internal pull-up is automatically activated in Internal Serial Clock Operation mode. The Serial Clock Operation mode is determined by the logic level applied to the SCK pin at power up or during the most recent falling edge of  $\overline{CS}$ .

**F<sub>0</sub> (Pin 14):** Frequency Control Pin. Digital input that controls the ADC's notch frequencies and conversion time. When the F<sub>0</sub> pin is connected to  $V_{CC}$  (LTC2435 only), the converter uses its internal oscillator and the digital filter first null is located at 50Hz. When the F<sub>0</sub> pin is connected to GND (F<sub>0</sub> = 0V), the converter uses its internal oscillator and the digital filter first null is located at 60Hz (LTC2435) or simultaneous 50Hz/60Hz (LTC2435-1). When F<sub>0</sub> is driven by an external clock signal with a frequency  $f_{EOSC}$ , the converter uses this signal as its system clock and the digital filter first null is located at a frequency  $f_{EOSC}/2560$ .

# FUNCTIONAL BLOCK DIAGRAM

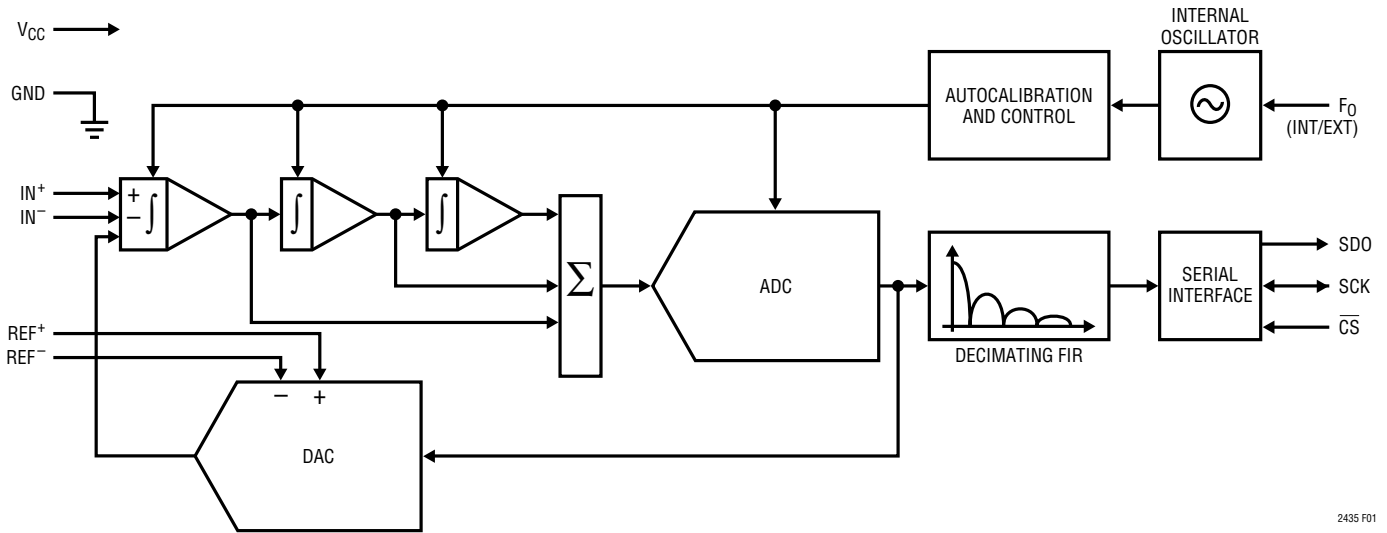

2435 F01

Figure 1. Functional Block Diagram

# TEST CIRCUITS

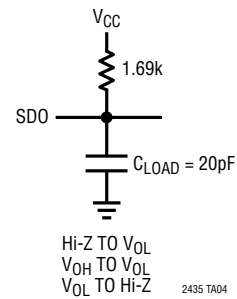
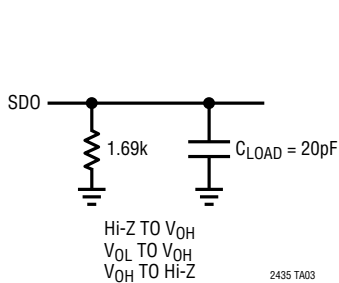

## APPLICATIONS INFORMATION

### CONVERTER OPERATION

#### Converter Operation Cycle

The LTC2435/LTC2435-1 are low power, delta-sigma analog-to-digital converters with an easy to use 3-wire serial interface (see Figure 1). Their operation is made up of three states. The converter operating cycle begins with the conversion, followed by the sleep state and ends with the data output (see Figure 2). The 3-wire interface consists of serial data output (SDO), serial clock (SCK) and chip select ( $\overline{CS}$ ).

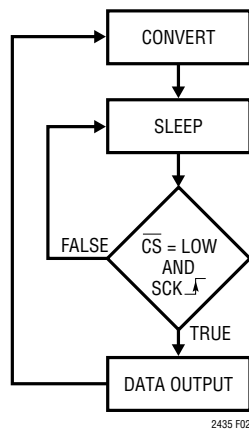

Figure 2. LTC2435 State Transition Diagram

Initially, the LTC2435/LTC2435-1 perform a conversion. Once the conversion is complete, the device enters the sleep state. While in this sleep state, power consumption is reduced by an order of magnitude if  $\overline{CS}$  is HIGH. The part remains in the sleep state as long as  $\overline{CS}$  is HIGH. The conversion result is held indefinitely in a static shift register while the converter is in the sleep state.

Once  $\overline{CS}$  is pulled LOW, the device exits the low power sleep mode and enters the data output state. If  $\overline{CS}$  is pulled HIGH before the first rising edge of SCK, the device returns to the sleep mode and the conversion result is still held in the internal static shift register. If  $\overline{CS}$  remains LOW after the first rising edge of SCK, the device begins outputting the conversion result. Taking  $\overline{CS}$  HIGH at this point will terminate the data output state and start a new conversion.

There is no latency in the conversion result. The data output corresponds to the conversion just performed. This result is shifted out on the serial data out pin (SDO) under the control of the serial clock (SCK). Data is updated on the falling edge of SCK allowing the user to reliably latch data on the rising edge of SCK (see Figure 3). The data output state is concluded once 24 bits are read out of the ADC or when  $\overline{CS}$  is brought HIGH. The device automatically initiates a new conversion and the cycle repeats.

Through timing control of the  $\overline{CS}$  and SCK pins, the LTC2435/LTC2435-1 offer several flexible modes of operation (internal or external SCK and free-running conversion modes). These various modes do not require programming configuration registers; moreover, they do not disturb the cyclic operation described above. These modes of operation are described in detail in the Serial Interface Timing Modes section.

#### Conversion Clock

A major advantage the delta-sigma converter offers over conventional type converters is an on-chip digital filter (commonly implemented as a Sinc or Comb filter). For high resolution, low frequency applications, this filter is typically designed to reject line frequencies of 50Hz or 60Hz plus their harmonics. The filter rejection performance is directly related to the accuracy of the converter system clock. The LTC2435/LTC2435-1 incorporate a highly accurate on-chip oscillator. This eliminates the need for external frequency setting components such as crystals or oscillators. Clocked by the on-chip oscillator, the LTC2435 achieves a minimum of 110dB rejection at the line frequency (50Hz or 60Hz  $\pm 2\%$ ), while the LTC2435-1 achieves a minimum of 87db rejection at 50Hz  $\pm 2\%$  and 60Hz  $\pm 2\%$  simultaneously.

#### Ease of Use

The LTC2435/LTC2435-1 data output has no latency, filter settling delay or redundant data associated with the conversion cycle. There is a one-to-one correspondence between the conversion and the output data. Therefore, multiplexing multiple analog voltages is easy.

## APPLICATIONS INFORMATION

The LTC2435/LTC2435-1 perform a full-scale calibration every conversion cycle. This calibration is transparent to the user and has no effect on the cyclic operation described above. The advantage of continuous calibration is extreme stability of full-scale readings with respect to time, supply voltage change and temperature drift.

Unlike the LTC2430, the LTC2435 and LTC2435-1 do not perform an offset calibration every conversion cycle. This enables the LTC2435/LTC2435-1 to double their output rate while maintaining line frequency rejection. The initial offset of the LTC2435/LTC2435-1 is within 5mV independent of  $V_{REF}$ . Based on the LTC2435/LTC2435-1 new modulator architecture, the temperature drift of the offset is less than 100nV/°C. More information on the LTC2435/LTC2435-1 offset is described in the Offset Accuracy and Drift section of this data sheet.

### Power-Up Sequence

The LTC2435/LTC2435-1 automatically enter an internal reset state when the power supply voltage  $V_{CC}$  drops below approximately 2.2V. This feature guarantees the integrity of the conversion result and of the serial interface mode selection. (See the 2-wire I/O sections in the Serial Interface Timing Modes section.)

When the  $V_{CC}$  voltage rises above this critical threshold, the converter creates an internal power-on-reset (POR) signal with a duration of approximately 1ms. The POR signal clears all internal registers. Following the POR signal, the LTC2435/LTC2435-1 start a normal conversion cycle and follow the succession of states described above. The first conversion result following POR is accurate within the specifications of the device if the power supply voltage is restored within the operating range (2.7V to 5.5V) before the end of the POR time interval.

### Reference Voltage Range

These converters accept a truly differential external reference voltage. The absolute/common mode voltage specification for the  $REF^+$  and  $REF^-$  pins covers the entire range from GND to  $V_{CC}$ . For correct converter operation, the  $REF^+$  pin must always be more positive than the  $REF^-$  pin.

The LTC2435/LTC2435-1 can accept a differential reference voltage from 0.1V to  $V_{CC}$ . The converter output noise is determined by the thermal noise of the front-end circuits, and as such, its value is nearly constant with reference voltage. A decrease in reference voltage will not significantly improve the converter's effective resolution. On the other hand, a reduced reference voltage will improve the converter's overall INL performance. A reduced reference voltage will also improve the converter performance when operated with an external conversion clock (external  $F_{O}$  signal) at substantially higher output data rates (see the Output Data Rate section).

### Input Voltage Range

The analog input is truly differential with an absolute/common mode range for the  $IN^+$  and  $IN^-$  input pins extending from  $GND - 0.3V$  to  $V_{CC} + 0.3V$ . Outside these limits, the ESD protection devices begin to turn on and the errors due to input leakage current increase rapidly. Within these limits, the LTC2435/LTC2435-1 convert the bipolar differential input signal,  $V_{IN} = IN^+ - IN^-$ , from  $-FS = -0.5 \cdot V_{REF}$  to  $+FS = 0.5 \cdot V_{REF}$  where  $V_{REF} = REF^+ - REF^-$ . Outside this range, the converters indicate the overrange or the underrange condition using distinct output codes.

Input signals applied to  $IN^+$  and  $IN^-$  pins may extend by 300mV below ground and above  $V_{CC}$ . In order to limit any fault current, resistors of up to 5k may be added in series with the  $IN^+$  and  $IN^-$  pins without affecting the performance of the device. In the physical layout, it is important to maintain the parasitic capacitance of the connection between these series resistors and the corresponding pins as low as possible; therefore, the resistors should be located as close as practical to the pins. The effect of the series resistance on the converter accuracy can be evaluated from the curves presented in the Input Current/Reference Current sections. In addition, series resistors will introduce a temperature dependent offset error due to the input leakage current. A 1nA input leakage current will develop a 1ppm offset error on a 5k resistor if  $V_{REF} = 5V$ . This error has a very strong temperature dependency.

## APPLICATIONS INFORMATION

### Output Data Format

The LTC2435/LTC2435-1 serial output data stream is 24 bits long. The first 3 bits represent status information indicating the sign and conversion state. The next 21 bits are the conversion result, MSB first. The third and fourth bit together are also used to indicate an underrange condition (the differential input voltage is below  $-FS$ ) or an overrange condition (the differential input voltage is above  $+FS$ ).

Bit 23 (first output bit) is the end of conversion ( $\overline{EOC}$ ) indicator. This bit is available at the SDO pin during the conversion and sleep states whenever the  $\overline{CS}$  pin is LOW. This bit is HIGH during the conversion and goes LOW when the conversion is complete.

Bit 22 (second output bit) is a dummy bit (DMY) and is always LOW.

Bit 21 (third output bit) is the conversion result sign indicator (SIG). If  $V_{IN}$  is  $>0$ , this bit is HIGH. If  $V_{IN}$  is  $<0$ , this bit is LOW.

Bit 20 (fourth output bit) is the most significant bit (MSB) of the result. This bit in conjunction with Bit 21 also provides the underrange or overrange indication. If both Bit 21 and Bit 20 are HIGH, the differential input voltage is above  $+FS$ . If both are LOW, the differential input voltage is below  $-FS$ .

The function of these bits is summarized in Table 1.

**Table 1. LTC2435/LTC2435-1 Status Bits**

Input Range	Bit 23 $\overline{EOC}$	Bit 22 DMY	Bit 21 SIG	Bit 20 MSB
$V_{IN} \geq 0.5 \cdot V_{REF}$	0	0	1	1
$0V \leq V_{IN} < 0.5 \cdot V_{REF}$	0	0	1	0
$-0.5 \cdot V_{REF} \leq V_{IN} < 0V$	0	0	0	1
$V_{IN} < -0.5 \cdot V_{REF}$	0	0	0	0

Bits 20-0 are the 21-bit conversion result MSB first.

Bit 0 is the least significant bit (LSB).

Data is shifted out of the SDO pin under control of the serial clock (SCK), see Figure 3. Whenever  $\overline{CS}$  is HIGH, SDO remains high impedance and any externally generated

SCK clock pulses are ignored by the internal data out shift register.

In order to shift the conversion result out of the device,  $\overline{CS}$  must first be driven LOW.  $\overline{EOC}$  is seen at the SDO pin of the device once  $\overline{CS}$  is pulled LOW.  $\overline{EOC}$  changes real time from HIGH to LOW at the completion of a conversion. This signal may be used as an interrupt for an external microcontroller. Bit 23 ( $\overline{EOC}$ ) can be captured on the first rising edge of SCK. Bit 22 is shifted out of the device on the first falling edge of SCK. The final data bit (Bit 0) is shifted out on the falling edge of the 23rd SCK and may be latched on the rising edge of the 24th SCK pulse. On the falling edge of the 24th SCK pulse, SDO goes HIGH indicating the initiation of a new conversion cycle. This bit serves as  $\overline{EOC}$  (Bit 23) for the next conversion cycle. Table 2 summarizes the output data format.

As long as the voltage on the  $IN^+$  and  $IN^-$  pins is maintained within the  $-0.3V$  to  $(V_{CC} + 0.3V)$  absolute maximum operating range, a conversion result is generated for any differential input voltage  $V_{IN}$  from  $-FS = -0.5 \cdot V_{REF}$  to  $+FS = 0.5 \cdot V_{REF}$ . For differential input voltages greater than  $+FS$ , the conversion result is clamped to the value corresponding to the  $+FS$ . For differential input voltages below  $-FS$ , the conversion result is clamped to the value corresponding to  $-FS - 1LSB$ .

### Offset Accuracy and Drift

Unlike the LTC2430 and most of the LTC2400 family, the LTC2435/LTC2435-1 do not perform an offset calibration every cycle. The reason for this is to increase the data output rate while maintaining line frequency rejection.

While the initial accuracy of the LTC2435/LTC2435-1 offset is within 5mV (see Figure 4), several unique properties of the LTC2435/LTC2435-1 architecture nearly eliminate the drift of the offset error with respect to temperature and supply.

As shown in Figure 5, the offset variation with temperature is less than 3ppm over the complete temperature range of  $-50^{\circ}C$  to  $100^{\circ}C$ . This corresponds to a temperature drift of 0.022ppm/ $^{\circ}C$ .

While the variation in offset with supply voltage is propor-



## APPLICATIONS INFORMATION

tional to  $V_{CC}$  (see Figure 4), several characteristics of this variation can be used to eliminate the effects. First, the variation with respect to supply voltage is linear. Second, the magnitude of the offset error decreases with decreased supply voltage. Third, the offset error in microvolts is almost independent with reference and therefore

the offset in ppm is inverse proportional to reference voltage. As a result, by tying  $V_{CC}$  to  $V_{REF}$ , the variation with supply can be reduced, see Figure 6. The variation with supply is less than 15ppm over the entire 2.7V to 5.5V supply range.

Table 2. LTC2435/LTC2435-1 Output Data Format

Differential Input Voltage $V_{IN}^*$	Bit 23 EOC	Bit 22 DMY	Bit 21 SIG	Bit 20 MSB	Bit 19	Bit 18	Bit 17	...	Bit 0
$V_{IN}^* \geq 0.5 \cdot V_{REF}^{**}$	0	0	1	1	0	0	0	...	0
$0.5 \cdot V_{REF}^{**} - 1LSB$	0	0	1	0	1	1	1	...	1
$0.25 \cdot V_{REF}^{**}$	0	0	1	0	1	0	0	...	0
$0.25 \cdot V_{REF}^{**} - 1LSB$	0	0	1	0	0	1	1	...	1
0	0	0	1	0	0	0	0	...	0
-1LSB	0	0	0	1	1	1	1	...	1
$-0.25 \cdot V_{REF}^{**}$	0	0	0	1	1	0	0	...	0
$-0.25 \cdot V_{REF}^{**} - 1LSB$	0	0	0	1	0	1	1	...	1
$-0.5 \cdot V_{REF}^{**}$	0	0	0	1	0	0	0	...	0
$V_{IN}^* < -0.5 \cdot V_{REF}^{**}$	0	0	0	0	1	1	1	...	1

\*The differential input voltage  $V_{IN} = IN^+ - IN^-$ .

\*\*The differential reference voltage  $V_{REF} = REF^+ - REF^-$ .

### Frequency Rejection Selection LTC2435 ( $F_0$ )

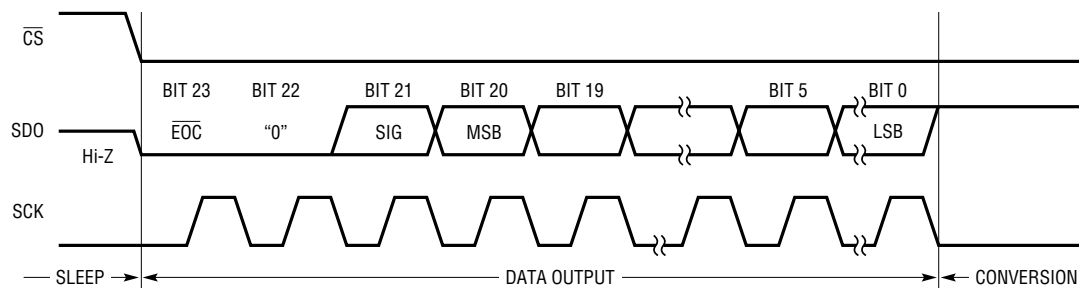

Figure 3. Output Data Timing

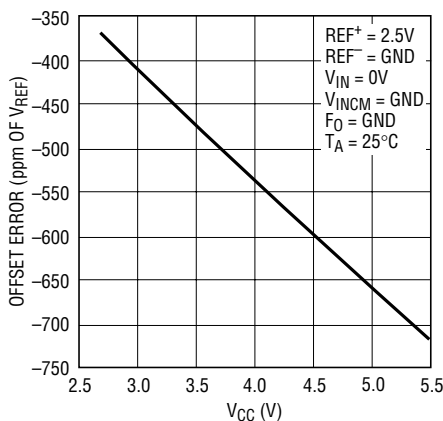

Figure 4. Offset vs  $V_{CC}$

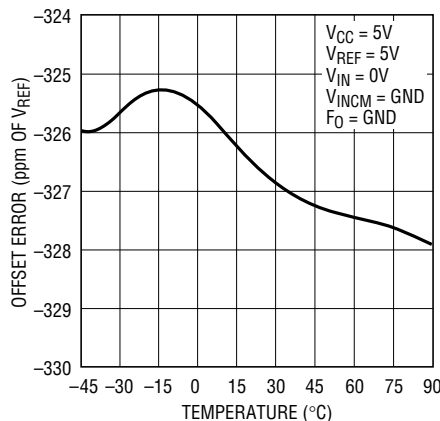

Figure 5. Offset vs Temperature

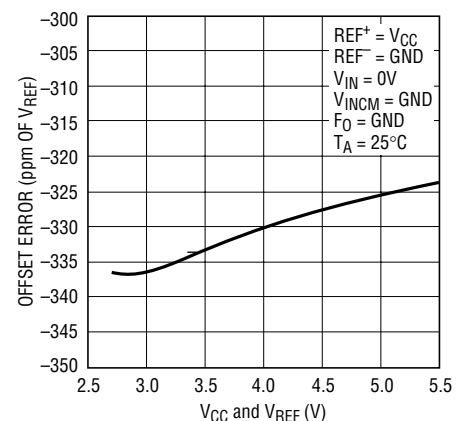

Figure 6. Offset vs  $V_{CC}$  ( $V_{REF} = V_{CC}$ )



## APPLICATIONS INFORMATION

The LTC2435 internal oscillator provides better than 110dB normal mode rejection at the line frequency and its harmonics for 50Hz  $\pm 2\%$  or 60Hz  $\pm 2\%$ . For 60Hz rejection,  $F_0$  should be connected to GND while for 50Hz rejection the  $F_0$  pin should be connected to  $V_{CC}$ .

The selection of 50Hz or 60Hz rejection can also be made by driving  $F_0$  to an appropriate logic level. A selection change during the sleep or data output states will not disturb the converter operation. If the selection is made during the conversion state, the result of the conversion in progress may be outside specifications but the following conversions will not be affected.

When a fundamental rejection frequency different from 50Hz or 60Hz is required or when the converter must be synchronized with an outside source, the LTC2435 can operate with an external conversion clock. The converter automatically detects the presence of an external clock signal at the  $F_0$  pin and turns off the internal oscillator. The frequency  $f_{EOSC}$  of the external signal must be at least 5kHz to be detected. The external clock signal duty cycle is not significant as long as the minimum and maximum specifications for the high and low periods  $t_{HEO}$  and  $t_{LEO}$  are observed.

While operating with an external conversion clock of a frequency  $f_{EOSC}$ , the LTC2435 provides better than 110dB normal mode rejection in a frequency range  $f_{EOSC}/2560 \pm 4\%$  and its harmonics. The normal mode rejection as a function of the input frequency deviation from  $f_{EOSC}/2560$  is shown in Figure 7a.

Whenever an external clock is not present at the  $F_0$  pin, the converter automatically activates its internal oscillator and enters the Internal Conversion Clock mode. The LTC2435 operation will not be disturbed if the change of conversion clock source occurs during the sleep state or during the data output state while the converter uses an external serial clock. If the change occurs during the conversion state, the result of the conversion in progress may be outside specifications but the following conversions will not be affected.

If the change occurs during the data output state and the converter is in the Internal SCK mode, the serial clock duty cycle may be affected but the serial data stream will remain valid.

Table 3a summarizes the duration of each state and the achievable output data rate as a function of  $F_0$ .

### Frequency Rejection Selection LTC2435-1 ( $F_0$ )

The LTC2435-1 internal oscillator provides better than 87dB normal mode rejection over the range of 49Hz to 61.2Hz as shown in Figure 7b. For simultaneous 50Hz/60Hz rejection,  $F_0$  should be connected to GND.

In order to achieve 87dB normal mode rejection of 50Hz  $\pm 2\%$  and 60Hz  $\pm 2\%$ , two consecutive conversions must be averaged. By performing a continuous running average of the two most current results, both simultaneous rejection is achieved and a nearly 2 $\times$  increase in throughput is realized relative to the LTC2430 (see Normal Mode Rejection, Output Rate and Running Averages sections of this data sheet).

When a fundamental rejection frequency different from the range 49Hz to 61.2Hz is required or when the converter must be synchronized with an outside source, the LTC2435-1 can operate with an external conversion clock. The performance of the LTC2435-1 is the same as the LTC2435 when driven by an external conversion clock at the  $F_0$  pin.

Table 3b summarizes the duration of each state and the achievable output data rate as a function of  $F_0$ .

### Serial Interface Pins

The LTC2435/LTC2435-1 transmit the conversion results and receive the start of conversion command through a synchronous 3-wire interface. During the conversion and sleep states, this interface can be used to assess the converter status and during the data output state it is used to read the conversion result.

## APPLICATIONS INFORMATION

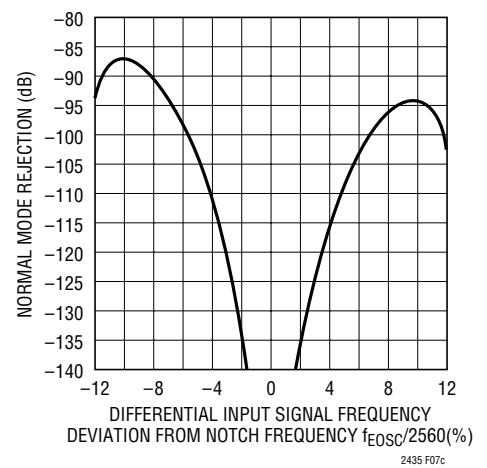
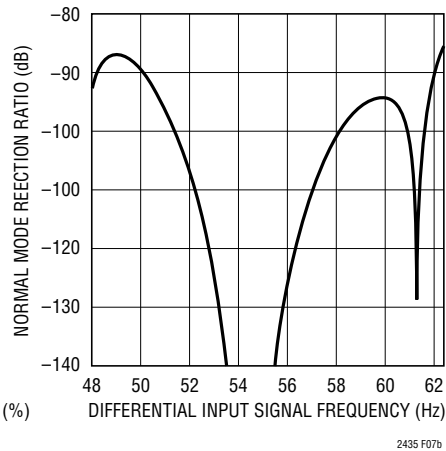
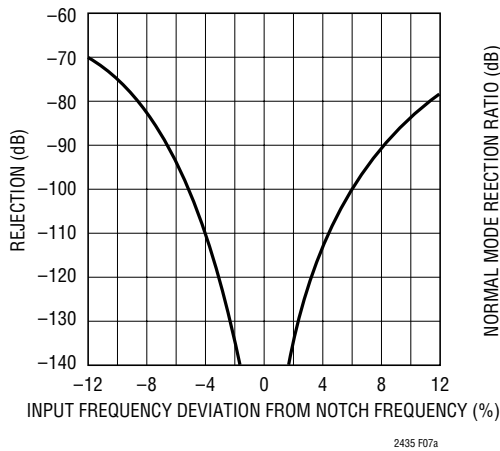

**Figure 7a. LTC2435/LTC2435-1 Normal Mode Rejection When Using an External Oscillator of Frequency  $f_{EOSC}$  without Running Averages**

**Figure 7b. LTC2435-1 Normal Mode Rejection When Using an Internal Oscillator with Running Averages**

**Figure 7c. LTC2435/LTC2435-1 Normal Mode Rejection When Using an External Oscillator of Frequency  $f_{EOSC}$  with Running Averages**

**Table 3a. LTC2435 State Duration**

State	Operating Mode		Duration
CONVERT	Internal Oscillator	$F_0 = \text{LOW}$ , (60Hz Rejection)	67ms, Output Data Rate $\leq 15$ Readings/s
		$F_0 = \text{HIGH}$ , (50Hz Rejection)	80ms, Output Data Rate $\leq 12.4$ Readings/s
	External Oscillator	$F_0 = \text{External Oscillator with Frequency } f_{EOSC} \text{ kHz (} f_{EOSC}/2560 \text{ Rejection)}$	$10278/f_{EOSC}s$ , Output Data Rate $\leq f_{EOSC}/10278$ Readings/s
SLEEP			As Long As $\overline{CS} = \text{HIGH}$
DATA OUTPUT	Internal Serial Clock	$F_0 = \text{LOW/HIGH}$ , (Internal Oscillator)	As Long As $\overline{CS} = \text{LOW}$ But Not Longer Than 1.25ms (24 SCK cycles)
		$F_0 = \text{External Oscillator with Frequency } f_{EOSC} \text{ kHz}$	As Long As $\overline{CS} = \text{LOW}$ But Not Longer Than $192/f_{EOSC}ms$ (24 SCK cycles)
	External Serial Clock with Frequency $f_{SCK} \text{ kHz}$		As Long As $\overline{CS} = \text{LOW}$ But Not Longer Than $24/f_{SCK}ms$ (24 SCK cycles)

**Table 3b. LTC2435-1 State Duration**

State	Operating Mode		Duration
CONVERT	Internal Oscillator	$F_0 = \text{LOW}$ Simultaneous 50Hz/60Hz Rejection	73ms, Output Data Rate $\leq 14$ Readings/s
	External Oscillator	$F_0 = \text{External Oscillator with Frequency } f_{EOSC} \text{ kHz (} f_{EOSC}/2560 \text{ Rejection)}$	$10278/f_{EOSC}s$ , Output Data Rate $\leq f_{EOSC}/10278$ Readings/s
SLEEP			As Long As $\overline{CS} = \text{HIGH}$
DATA OUTPUT	Internal Serial Clock	$F_0 = \text{LOW}$ (Internal Oscillator)	As Long As $\overline{CS} = \text{LOW}$ But Not Longer Than 1.4ms (24 SCK cycles)
		$F_0 = \text{External Oscillator with Frequency } f_{EOSC} \text{ kHz}$	As Long As $\overline{CS} = \text{LOW}$ But Not Longer Than $192/f_{EOSC}ms$ (24 SCK cycles)
	External Serial Clock with Frequency $f_{SCK} \text{ kHz}$		As Long As $\overline{CS} = \text{LOW}$ But Not Longer Than $24/f_{SCK}ms$ (24 SCK cycles)

## APPLICATIONS INFORMATION

### Serial Clock Input/Output (SCK)

The serial clock signal present on SCK (Pin 13) is used to synchronize the data transfer. Each bit of data is shifted out the SDO pin on the falling edge of the serial clock.

In the Internal SCK mode of operation, the SCK pin is an output and the LTC2435/LTC2435-1 create their own serial clock by dividing the internal conversion clock by 8. In the External SCK mode of operation, the SCK pin is used as input. The internal or external SCK mode is selected on power-up and then reselected every time a HIGH-to-LOW transition is detected at the  $\overline{CS}$  pin. If SCK is HIGH or floating at power-up or during this transition, the converter enters the internal SCK mode. If SCK is LOW at power-up or during this transition, the converter enters the external SCK mode.

### Serial Data Output (SDO)

The serial data output pin, SDO (Pin 12), provides the result of the last conversion as a serial bit stream (MSB first) during the data output state. In addition, the SDO pin is used as an end of conversion indicator during the conversion and sleep states.

When  $\overline{CS}$  (Pin 11) is HIGH, the SDO driver is switched to a high impedance state. This allows sharing the serial interface with other devices. If  $\overline{CS}$  is LOW during the convert or sleep state, SDO will output  $\overline{EOC}$ . If  $\overline{CS}$  is LOW during the conversion phase, the  $\overline{EOC}$  bit appears HIGH on the SDO pin. Once the conversion is complete,  $\overline{EOC}$  goes LOW.

### Chip Select Input ( $\overline{CS}$ )

The active LOW chip select,  $\overline{CS}$  (Pin 11), is used to test the conversion status and to enable the data output transfer as described in the previous sections.

In addition, the  $\overline{CS}$  signal can be used to trigger a new conversion cycle before the entire serial data transfer has been completed. The LTC2435/LTC2435-1 will abort any serial data transfer in progress and start a new conversion cycle anytime a LOW-to-HIGH transition is detected at the  $\overline{CS}$  pin after the converter has entered the data output state (i.e., after the first rising edge of SCK occurs with  $\overline{CS} = \text{LOW}$ ).

Finally,  $\overline{CS}$  can be used to control the free-running modes of operation, see Serial Interface Timing Modes section. Grounding  $\overline{CS}$  will force the ADC to continuously convert at the maximum output rate selected by  $F_0$ .

## SERIAL INTERFACE TIMING MODES

The LTC2435/LTC2435-1 3-wire interface is SPI and MICROWIRE compatible. This interface offers several flexible modes of operation. These include internal/external serial clock, 2- or 3-wire I/O, single cycle conversion and autostart. The following sections describe each of these serial interface timing modes in detail. In all these cases, the converter can use the internal oscillator ( $F_0 = \text{LOW}$  or  $F_0 = \text{HIGH}$ ) or an external oscillator connected to the  $F_0$  pin. Refer to Table 4 for a summary.

**Table 4. LTC2435/LTC2435-1 Interface Timing Modes**

Configuration	SCK Source	Conversion Cycle Control	Data Output Control	Connection and Waveforms
External SCK, Single Cycle Conversion	External	$\overline{CS}$ and SCK	$\overline{CS}$ and SCK	Figures 8, 9
External SCK, 2-Wire I/O	External	SCK	SCK	Figure 10
Internal SCK, Single Cycle Conversion	Internal	$\overline{CS} \downarrow$	$\overline{CS} \downarrow$	Figures 11, 12
Internal SCK, 2-Wire I/O, Continuous Conversion	Internal	Continuous	Internal	Figure 13

## APPLICATIONS INFORMATION

### External Serial Clock, Single Cycle Operation (SPI/MICROWIRE Compatible)

This timing mode uses an external serial clock to shift out the conversion result and a  $\overline{CS}$  signal to monitor and control the state of the conversion cycle, see Figure 8.

The serial clock mode is selected on the falling edge of  $\overline{CS}$ . To select the external serial clock mode, the serial clock pin (SCK) must be LOW during each  $\overline{CS}$  falling edge.

The serial data output pin (SDO) is Hi-Z as long as  $\overline{CS}$  is HIGH. At any time during the conversion cycle,  $\overline{CS}$  may be pulled LOW in order to monitor the state of the converter. While  $\overline{CS}$  is pulled LOW,  $\overline{EOC}$  is output to the SDO pin.  $\overline{EOC} = 1$  while a conversion is in progress and  $\overline{EOC} = 0$  if the conversion is over. With  $\overline{CS}$  HIGH, the device automatically enters the sleep state once the conversion is complete.

When  $\overline{CS}$  is low, the device enters the data output mode. The result is held in the internal static shift register until the first SCK rising edge is seen while  $\overline{CS}$  is LOW. Data is shifted out the SDO pin on each falling edge of SCK. This enables external circuitry to latch the output on the rising edge of SCK.  $\overline{EOC}$  can be latched on the first rising edge of SCK and the last bit of the conversion result can be

latched on the 24th rising edge of SCK. On the 24th falling edge of SCK, the device begins a new conversion. SDO goes HIGH ( $\overline{EOC} = 1$ ) indicating a conversion is in progress.

At the conclusion of the data cycle,  $\overline{CS}$  may remain LOW and  $\overline{EOC}$  monitored as an end-of-conversion interrupt. Alternatively,  $\overline{CS}$  may be driven HIGH setting SDO to Hi-Z. As described above,  $\overline{CS}$  may be pulled LOW at any time in order to monitor the conversion status.

Typically,  $\overline{CS}$  remains LOW during the data output state. However, the data output state may be aborted by pulling  $\overline{CS}$  HIGH anytime between the first rising edge and the 24th falling edge of SCK, see Figure 9. On the rising edge of  $\overline{CS}$ , the device aborts the data output state and immediately initiates a new conversion. This is useful for systems not requiring all 24 bits of output data, aborting an invalid conversion cycle or synchronizing the start of a conversion.

### External Serial Clock, 2-Wire I/O

This timing mode utilizes a 2-wire serial I/O interface. The conversion result is shifted out of the device by an externally generated serial clock (SCK) signal, see Figure 10.  $\overline{CS}$  may be permanently tied to ground, simplifying the user interface or isolation barrier.

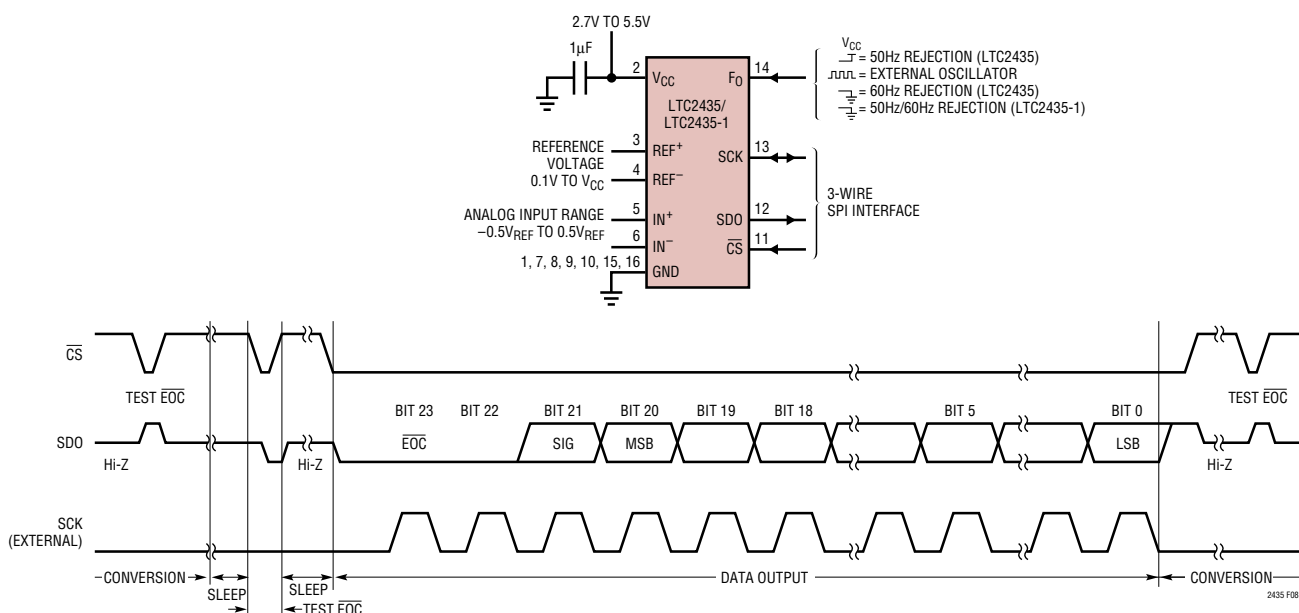

Figure 8. External Serial Clock, Single Cycle Operation

## APPLICATIONS INFORMATION

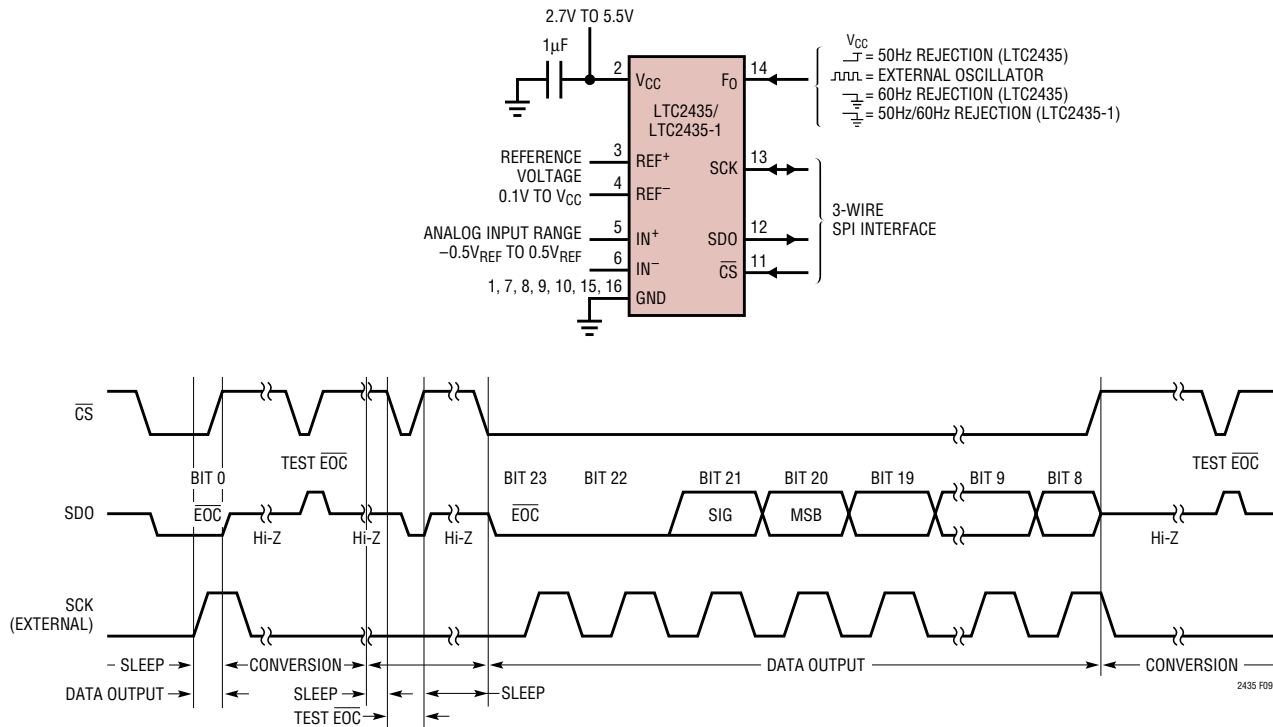

Figure 9. External Serial Clock, Reduced Data Output Length

The external serial clock mode is selected at the end of the power-on reset (POR) cycle. The POR cycle is concluded approximately 1ms after  $V_{CC}$  exceeds 2.2V. The level applied to SCK at this time determines if SCK is internal or external. SCK must be driven LOW prior to the end of POR in order to enter the external serial clock timing mode.

Since  $\overline{CS}$  is tied LOW, the end-of-conversion ( $\overline{EOC}$ ) can be continuously monitored at the SDO pin during the convert and sleep states.  $\overline{EOC}$  may be used as an interrupt to an external controller indicating the conversion result is ready.  $\overline{EOC} = 1$  while the conversion is in progress and  $\overline{EOC} = 0$  once the conversion is over. On the falling edge of  $\overline{EOC}$ , the conversion result is loaded into an internal static shift register. Data is shifted out the SDO pin on each falling edge of SCK enabling external circuitry to latch data on the rising edge of SCK.  $\overline{EOC}$  can be latched on the first rising edge of SCK. On the 24th falling edge of SCK, SDO goes HIGH ( $\overline{EOC} = 1$ ) indicating a new conversion has begun.

### Internal Serial Clock, Single Cycle Operation

This timing mode uses an internal serial clock to shift out the conversion result and a  $\overline{CS}$  signal to monitor and control the state of the conversion cycle, see Figure 11.

In order to select the internal serial clock timing mode, the serial clock pin (SCK) must be floating (Hi-Z) or pulled HIGH prior to the falling edge of  $\overline{CS}$ . The device will not enter the internal serial clock mode if SCK is driven LOW on the falling edge of  $\overline{CS}$ . An internal weak pull-up resistor is active on the SCK pin during the falling edge of  $\overline{CS}$ ; therefore, the internal serial clock timing mode is automatically selected if SCK is not externally driven.

The serial data output pin (SDO) is Hi-Z as long as  $\overline{CS}$  is HIGH. At any time during the conversion cycle,  $\overline{CS}$  may be pulled LOW in order to monitor the state of the converter. Once  $\overline{CS}$  is pulled LOW, SCK goes LOW and  $\overline{EOC}$  is output to the SDO pin.  $\overline{EOC} = 1$  while a conversion is in progress and  $\overline{EOC} = 0$  if the conversion is over.

## APPLICATIONS INFORMATION

When testing  $\overline{EOC}$ , if the conversion is complete ( $\overline{EOC} = 0$ ), the device will exit the sleep state and enter the data output state. In order to allow the device to return to the sleep state,  $\overline{CS}$  must be pulled HIGH before the first rising edge of SCK. In the internal SCK timing mode, SCK goes HIGH

and the device begins outputting data at time  $t_{EOCtest}$  after the falling edge of  $\overline{CS}$  (if  $EOC = 0$ ) or  $t_{EOCtest}$  after  $\overline{EOC}$  goes LOW (if CS is LOW during the falling edge of  $\overline{EOC}$ ). The value of  $t_{EOCtest}$  is 23 $\mu$ s (LTC2435), 26 $\mu$ s (LTC2435-1) if the device is using its internal oscillator ( $F_0 = \text{logic LOW}$  or

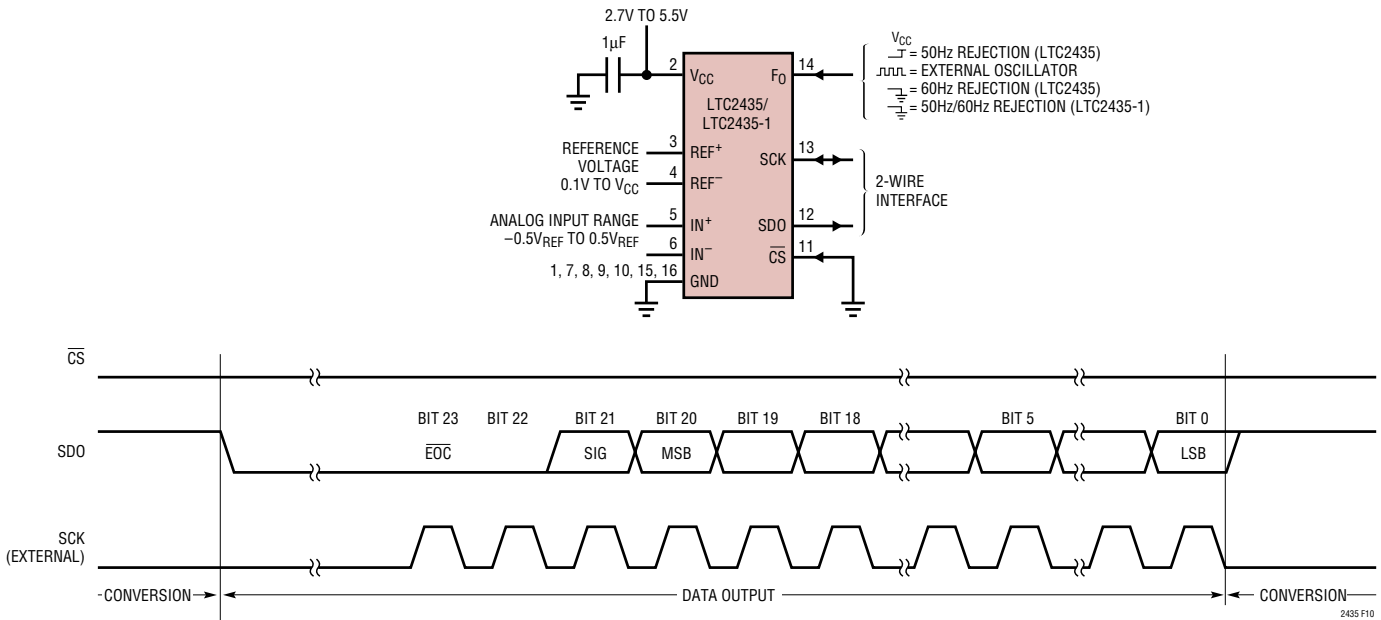

Figure 10. External Serial Clock,  $\overline{CS} = 0$  Operation (2-Wire)

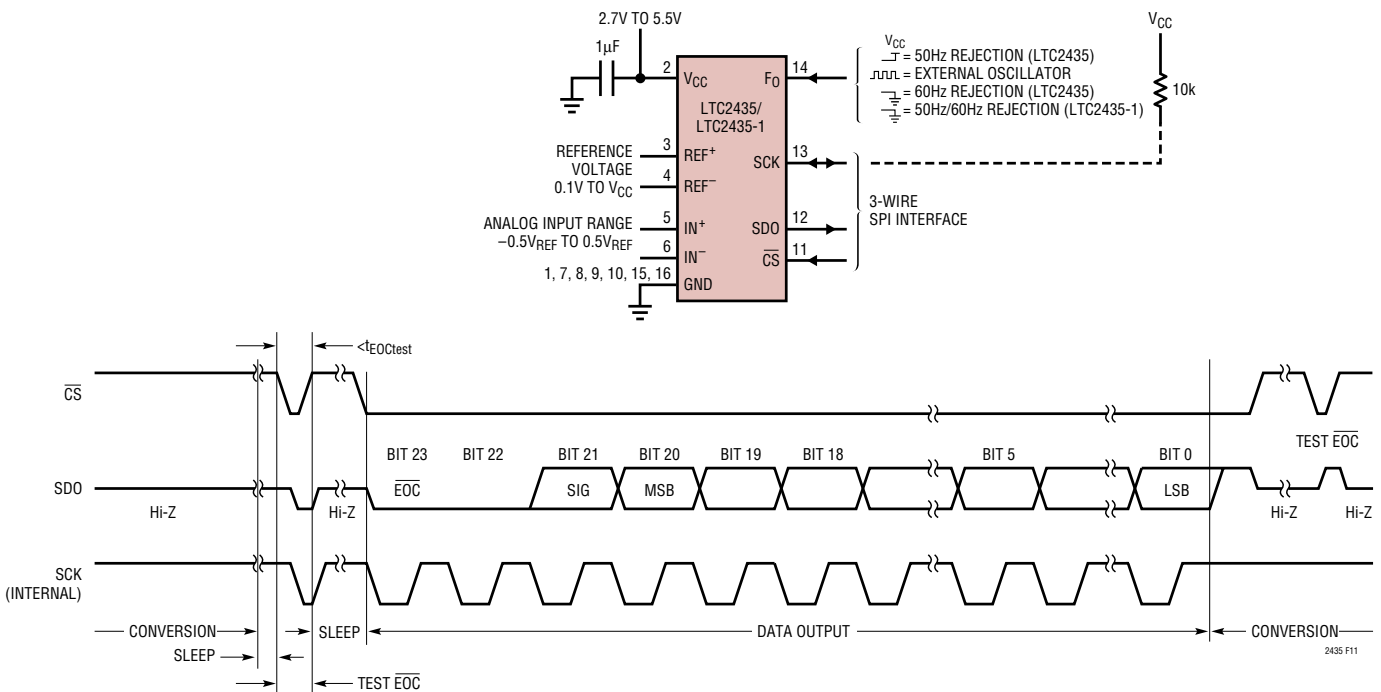

Figure 11. Internal Serial Clock, Single Cycle Operation



## APPLICATIONS INFORMATION

HIGH). If  $F_0$  is driven by an external oscillator of frequency  $f_{EOSC}$ , then  $t_{EOCtest}$  is  $3.6/f_{EOSC}$ . If  $\overline{CS}$  is pulled HIGH before time  $t_{EOCtest}$ , the device returns to the sleep state. The conversion result is held in the internal static shift register.

If  $\overline{CS}$  remains LOW longer than  $t_{EOCtest}$ , the first rising edge of SCK will occur and the conversion result is serially shifted out of the SDO pin. The data output cycle begins on this first rising edge of SCK and concludes after the 24th rising edge. Data is shifted out the SDO pin on each falling edge of SCK. The internally generated serial clock is output to the SCK pin. This signal may be used to shift the conversion result into external circuitry.  $\overline{EOC}$  can be latched on the first rising edge of SCK and the last bit of the conversion result on the 24th rising edge of SCK. After the 24th rising edge, SDO goes HIGH ( $EOC = 1$ ), SCK stays HIGH and a new conversion starts.

Typically,  $\overline{CS}$  remains LOW during the data output state. However, the data output state may be aborted by pulling  $\overline{CS}$  HIGH anytime between the first and 24th rising edge of SCK, see Figure 12. On the rising edge of  $\overline{CS}$ , the device aborts the data output state and immediately initiates a

new conversion. This is useful for systems not requiring all 24 bits of output data, aborting an invalid conversion cycle, or synchronizing the start of a conversion. If  $\overline{CS}$  is pulled HIGH while the converter is driving SCK LOW, the internal pull-up is not available to restore SCK to a logic HIGH state. This will cause the device to exit the internal serial clock mode on the next falling edge of  $\overline{CS}$ . This can be avoided by adding an external 10k pull-up resistor to the SCK pin or by never pulling  $\overline{CS}$  HIGH when SCK is LOW.

Whenever SCK is LOW, the LTC2435/LTC2435-1 internal pull-up at pin SCK is disabled. Normally, SCK is not externally driven if the device is in the internal SCK timing mode. However, certain applications may require an external driver on SCK. If this driver goes Hi-Z after outputting a LOW signal, the LTC2435/LTC2435-1 internal pull-up remains disabled. Hence, SCK remains LOW. On the next falling edge of  $\overline{CS}$ , the device is switched to the external SCK timing mode. By adding an external 10k pull-up resistor to SCK, this pin goes HIGH once the external driver goes Hi-Z. On the next  $\overline{CS}$  falling edge, the device will remain in the internal SCK timing mode.

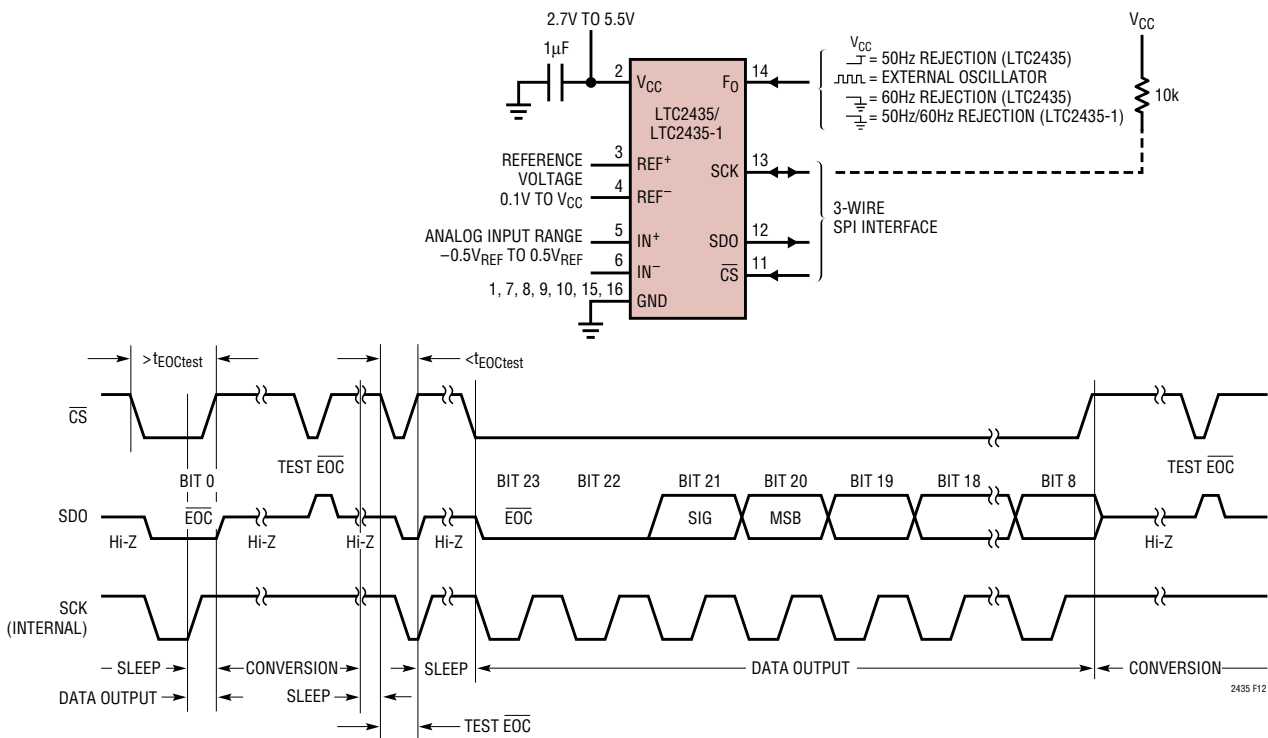

Figure 12. Internal Serial Clock, Reduced Data Output Length



## APPLICATIONS INFORMATION

A similar situation may occur during the sleep state when  $\overline{CS}$  is pulsed HIGH-LOW-HIGH in order to test the conversion status. If the device is in the sleep state ( $\overline{EOC} = 0$ ), SCK will go LOW. Once  $\overline{CS}$  goes HIGH (within the time period defined above as  $t_{EOCtest}$ ), the internal pull-up is activated. For a heavy capacitive load on the SCK pin, the internal pull-up may not be adequate to return SCK to a HIGH level before  $\overline{CS}$  goes low again. This is not a concern under normal conditions where  $\overline{CS}$  remains LOW after detecting  $\overline{EOC} = 0$ . This situation is easily overcome by adding an external 10k pull-up resistor to the SCK pin.

### Internal Serial Clock, 2-Wire I/O, Continuous Conversion

This timing mode uses a 2-wire, all output (SCK and SDO) interface. The conversion result is shifted out of the device by an internally generated serial clock (SCK) signal, see Figure 13.  $\overline{CS}$  may be permanently tied to ground, simplifying the user interface or isolation barrier.

The internal serial clock mode is selected at the end of the power-on reset (POR) cycle. The POR cycle is concluded

approximately 1ms after  $V_{CC}$  exceeds 2.2V. An internal weak pull-up is active during the POR cycle; therefore, the internal serial clock timing mode is automatically selected if SCK is not externally driven LOW (if SCK is loaded such that the internal pull-up cannot pull the pin HIGH, the external SCK mode will be selected).

During the conversion, the SCK and the serial data output pin (SDO) are HIGH ( $\overline{EOC} = 1$ ). Once the conversion is complete, SCK and SDO go LOW ( $\overline{EOC} = 0$ ) indicating the conversion has finished. The data output cycle begins on the first rising edge of SCK and ends after the 24th rising edge of SCK. Data is shifted out the SDO pin on each falling edge of SCK. The internally generated serial clock is output to the SCK pin. This signal may be used to shift the conversion result into external circuitry.  $\overline{EOC}$  can be latched on the first rising edge of SCK and the last bit of the conversion result can be latched on the 24th rising edge of SCK. After the 24th rising edge, SDO goes HIGH ( $\overline{EOC} = 1$ ) indicating a new conversion is in progress. SCK remains HIGH during the conversion.

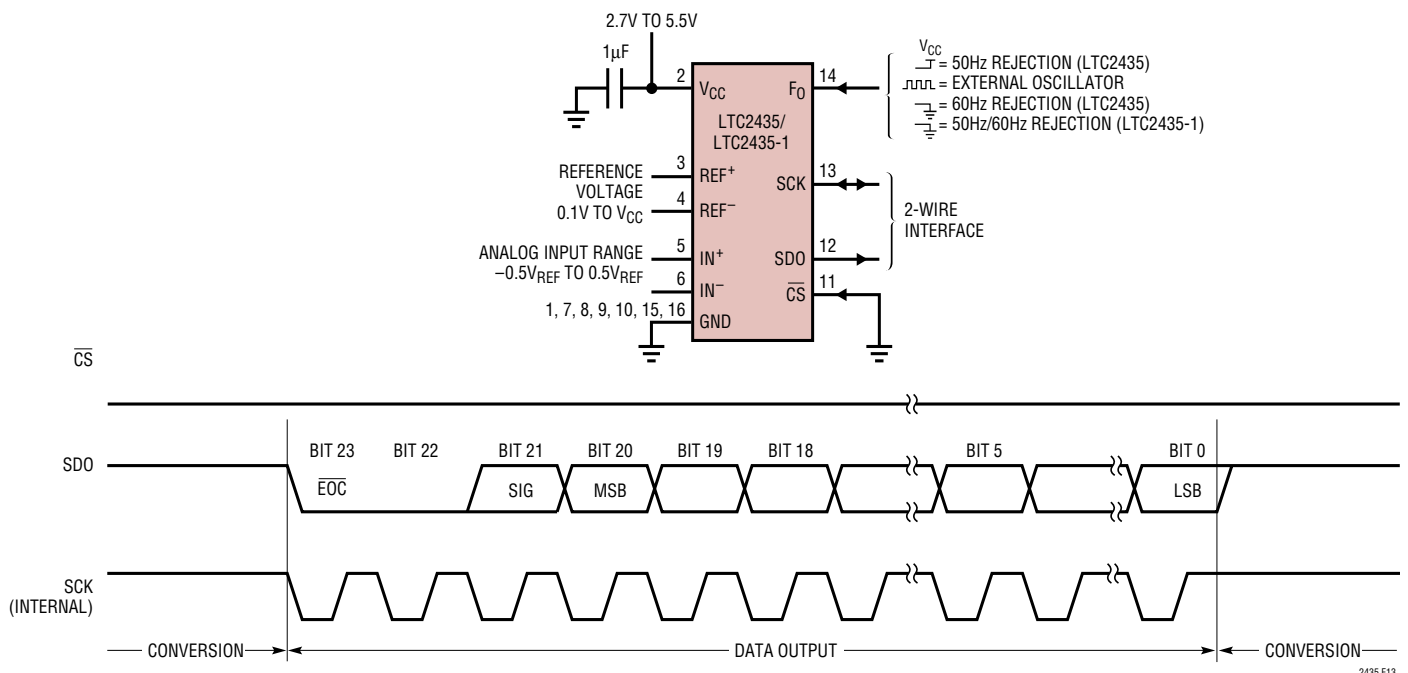

Figure 13. Internal Serial Clock, Continuous Operation

24351fb

## APPLICATIONS INFORMATION

### PRESERVING THE CONVERTER ACCURACY

The LTC2435/LTC2435-1 are designed to reduce as much as possible conversion result sensitivity to device decoupling, PCB layout, antialiasing circuits, line frequency perturbations and so on. Nevertheless, in order to preserve the extreme accuracy capability of this part, some simple precautions are desirable.

### Digital Signal Levels

The LTC2435/LTC2435-1 digital interface is easy to use. Its digital inputs ( $F_0$ ,  $\overline{CS}$  and SCK in External SCK mode of operation) accept standard TTL/CMOS logic levels and the internal hysteresis receivers can tolerate edge rates as slow as 100 $\mu$ s. However, some considerations are required to take advantage of the exceptional accuracy and low supply current of this converter.

The digital output signals (SDO and SCK in Internal SCK mode of operation) are less of a concern because they are not generally active during conversion.

While a digital input signal is in the range 0.5V to ( $V_{CC} - 0.5V$ ), the CMOS input receiver draws additional current from the power supply. It should be noted that, when any one of the digital input signals ( $F_0$ ,  $\overline{CS}$  and SCK in External SCK mode of operation) is within this range, the LTC2435/LTC2435-1 power supply current may increase even if the signal in question is at a valid logic level. For micropower operation, it is recommended to drive all digital input signals to full CMOS levels [ $V_{IL} < 0.4V$  and  $V_{OH} > (V_{CC} - 0.4V)$ ].

During the conversion period, the undershoot and/or overshoot of a fast digital signal connected to the LTC2435/LTC2435-1 pins may severely disturb the analog to digital conversion process. Undershoot and overshoot can occur because of the impedance mismatch at the converter pin when the transition time of an external control signal is less than twice the propagation delay from the driver to LTC2435/LTC2435-1. For reference, on a regular FR-4 board, signal propagation velocity is approximately 183ps/inch for internal traces and 170ps/inch for surface traces. Thus, a driver generating a control signal with a minimum transition time of 1ns must be connected to the

converter pin through a trace shorter than 2.5 inches. This problem becomes particularly difficult when shared control lines are used and multiple reflections may occur. The solution is to carefully terminate all transmission lines close to their characteristic impedance.

Parallel termination near the LTC2435/LTC2435-1 pins will eliminate this problem but will increase the driver power dissipation. A series resistor between 27 $\Omega$  and 56 $\Omega$  placed near the driver or near the LTC2435/LTC2435-1 pins will also eliminate this problem without additional power dissipation. The actual resistor value depends upon the trace impedance and connection topology.

An alternate solution is to reduce the edge rate of the control signals. It should be noted that using very slow edges will increase the converter power supply current during the transition time. The multiple ground pins used in this package configuration, as well as the differential input and reference architecture, reduce substantially the converter's sensitivity to ground currents.

Particular attention must be given to the connection of the  $F_0$  signal when the LTC2435/LTC2435-1 are used with an external conversion clock. This clock is active during the conversion time and the normal mode rejection provided by the internal digital filter is not very high at this frequency. A normal mode signal of this frequency at the converter reference terminals may result in DC gain and INL errors. A normal mode signal of this frequency at the converter input terminals may result in a DC offset error. Such perturbations may occur due to asymmetric capacitive coupling between the  $F_0$  signal trace and the converter input and/or reference connection traces. An immediate solution is to maintain maximum possible separation between the  $F_0$  signal trace and the input/reference signals. When the  $F_0$  signal is parallel terminated near the converter, substantial AC current is flowing in the loop formed by the  $F_0$  connection trace, the termination and the ground return path. Thus, perturbation signals may be inductively coupled into the converter input and/or reference. In this situation, the user must reduce to a minimum the loop area for the  $F_0$  signal as well as the loop area for the differential input and reference connections.

## APPLICATIONS INFORMATION

### Driving the Input and Reference

The input and reference pins of the LTC2435/LTC2435-1 converters are directly connected to a network of sampling capacitors. Depending upon the relation between the differential input voltage and the differential reference voltage, these capacitors are switching between these four pins transferring small amounts of charge in the process. A simplified equivalent circuit is shown in Figure 14.

For a simple approximation, the source impedance  $R_S$  driving an analog input pin ( $IN^+$ ,  $IN^-$ ,  $REF^+$  or  $REF^-$ ) can be considered to form, together with  $R_{SW}$  and  $C_{EQ}$  (see Figure 14), a first order passive network with a time constant  $\tau = (R_S + R_{SW}) \cdot C_{EQ}$ . The converter is able to sample the input signal with better than 1ppm accuracy if the sampling period is at least 14 times greater than the input circuit time constant  $\tau$ . The sampling process on the four input analog pins is quasi-independent so each time constant should be considered by itself and, under worst-case circumstances, the errors may add.

When using the internal oscillator ( $F_0 = \text{LOW}$  or  $\text{HIGH}$ ), the LTC2435's front-end switched-capacitor network is clocked at 76800Hz corresponding to a 13 $\mu\text{s}$  sampling period and the LTC2435-1's front end is clocked at 69900Hz corresponding to 14.2 $\mu\text{s}$ . Thus, for settling errors of less than 1ppm, the driving source impedance should be chosen such that  $\tau \leq 13\mu\text{s}/14 = 920\text{ns}$  (LTC2435) and  $\tau < 14.2\mu\text{s}/14 = 1.01\mu\text{s}$  (LTC2435-1). When an external oscillator of frequency  $f_{EOSC}$  is used, the sampling period is  $2/f_{EOSC}$  and, for a settling error of less than 1ppm,  $\tau \leq 0.14/f_{EOSC}$ .

### Input Current

If complete settling occurs on the input, conversion results will be unaffected by the dynamic input current. An incomplete settling of the input signal sampling process may result in gain and offset errors, but it will not degrade the INL performance of the converter. Figure 14 shows the mathematical expressions for the average bias currents flowing through the  $IN^+$  and  $IN^-$  pins as a result of the sampling charge transfers when integrated over a substantial time period (longer than 64 internal clock cycles).

The effect of this input dynamic current can be analyzed using the test circuit of Figure 15. The  $C_{PAR}$  capacitor includes the LTC2435/LTC2435-1 pin capacitance (5pF typical) plus the capacitance of the test fixture used to obtain the results shown in Figures 16 and 17. A careful implementation can bring the total input capacitance ( $C_{IN} + C_{PAR}$ ) closer to 5pF thus achieving better performance than the one predicted by Figures 16 and 17. For simplicity, two distinct situations can be considered.

For relatively small values of input capacitance ( $C_{IN} < 0.01\mu\text{F}$ ), the voltage on the sampling capacitor settles almost completely and relatively large values for the source impedance result in only small errors. Such values for  $C_{IN}$  will deteriorate the converter offset and gain performance without significant benefits of signal filtering and the user is advised to avoid them. Nevertheless, when small values of  $C_{IN}$  are unavoidably present as parasitics of input multiplexers, wires, connectors or sensors, the LTC2435/LTC2435-1 can maintain their exceptional accuracy while operating with relative large values of source resistance as shown in Figures 16 and 17. These measured results may be slightly different from the first order approximation suggested earlier because they include the effect of the actual second order input network together with the nonlinear settling process of the input amplifiers. For small  $C_{IN}$  values, the settling on  $IN^+$  and  $IN^-$  occurs almost independently and there is little benefit in trying to match the source impedance for the two pins.

Larger values of input capacitors ( $C_{IN} > 0.01\mu\text{F}$ ) may be required in certain configurations for antialiasing or general input signal filtering. Such capacitors will average the input sampling charge and the external source resistance will see a quasi constant input differential impedance. When  $F_0 = \text{LOW}$  (internal oscillator and 60Hz notch), the typical differential input resistance is 22M $\Omega$  (LTC2435) or 24M $\Omega$  (LTC2435-1) which will generate a +FS gain error of approximately 0.023ppm (LTC2435) or 0.021ppm (LTC2435-1) for each ohm of source resistance driving  $IN^+$  or  $IN^-$ . For the LTC2435, when  $F_0 = \text{HIGH}$  (internal oscillator and 50Hz notch), the typical differential input resistance is 26M $\Omega$  which will generate a +FS gain error of approximately 0.019ppm for each ohm of source resis-

## APPLICATIONS INFORMATION

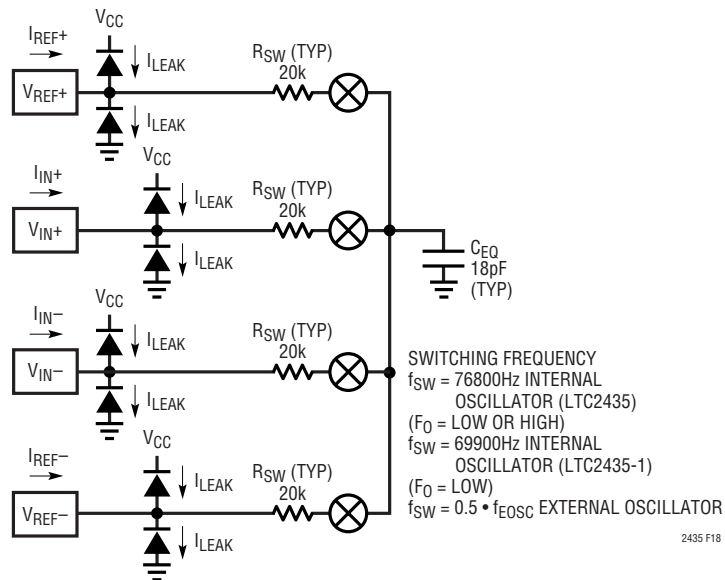

$$I(IN^+)_{AVG} = \frac{V_{IN} + V_{INCM} - V_{REFCM}}{0.5 \cdot R_{EQ}}$$

$$I(IN^-)_{AVG} = \frac{-V_{IN} + V_{INCM} - V_{REFCM}}{0.5 \cdot R_{EQ}}$$

$$I(REF^+)_{AVG} = \frac{1.5 \cdot V_{REF} - V_{INCM} + V_{REFCM}}{0.5 \cdot R_{EQ}} - \frac{V_{IN}^2}{V_{REF} \cdot R_{EQ}}$$

$$I(REF^-)_{AVG} = \frac{-1.5 \cdot V_{REF} - V_{INCM} + V_{REFCM}}{0.5 \cdot R_{EQ}} + \frac{V_{IN}^2}{V_{REF} \cdot R_{EQ}}$$

where:

$$V_{REF} = REF^+ - REF^-$$

$$V_{REFCM} = \left( \frac{REF^+ + REF^-}{2} \right)$$

$$V_{IN} = IN^+ - IN^-$$

$$V_{INCM} = \left( \frac{IN^+ + IN^-}{2} \right)$$

$R_{EQ} = 43.2M\Omega$  INTERNAL OSCILLATOR 60Hz NOTCH ( $F_0 = LOW$ ) LTC2435  
 $R_{EQ} = 52M\Omega$  INTERNAL OSCILLATOR 50Hz NOTCH ( $F_0 = HIGH$ ) LTC2435  
 $R_{EQ} = 48M\Omega$  INTERNAL OSCILLATOR 50Hz/60Hz NOTCH ( $F_0 = LOW$ ) LTC2435-1  
 $R_{EQ} = (6.7 \cdot 10^{12})/f_{EOSC}$  EXTERNAL OSCILLATOR

Figure 14. LTC2435/LTC2435-1 Equivalent Analog Input Circuit

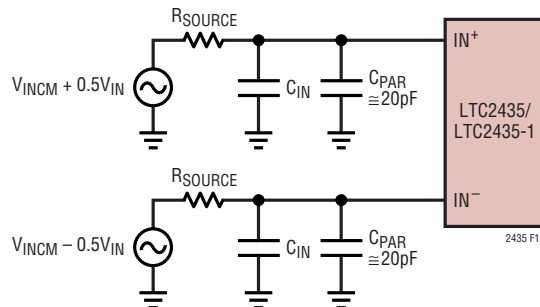

Figure 15. An RC Network at IN+ and IN-

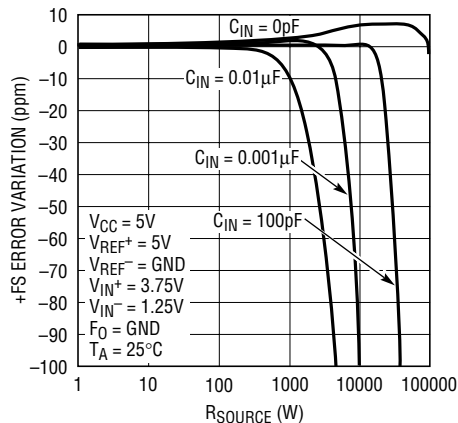

Figure 16. +FS Error vs  $R_{SOURCE}$  at  $IN^+$  or  $IN^-$  (Small  $C_{IN}$ )

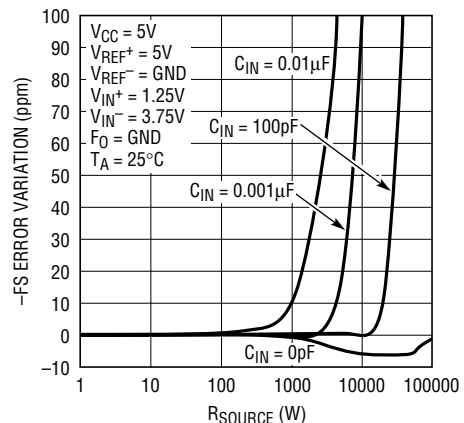

Figure 17. -FS Error vs  $R_{SOURCE}$  at  $IN^+$  or  $IN^-$  (Small  $C_{IN}$ )

## APPLICATIONS INFORMATION

tance driving  $IN^+$  or  $IN^-$ . When  $F_0$  is driven by an external oscillator with a frequency  $f_{EOSC}$  (external conversion clock operation), the typical differential input resistance is  $3.3 \cdot 10^{12}/f_{EOSC}\Omega$  and each ohm of source resistance driving  $IN^+$  or  $IN^-$  will result in  $0.15 \cdot 10^{-6} \cdot f_{EOSC}$  ppm +FS gain error. The effect of the source resistance on the two input pins is additive with respect to this gain error. The typical +FS and -FS errors as a function of the sum of the source resistance seen by  $IN^+$  and  $IN^-$  for large values of  $C_{IN}$  are shown in Figures 18 and 19.

In addition to this gain error, an offset error term may also appear. The offset error is proportional to the mismatch between the source impedance driving the two input pins  $IN^+$  and  $IN^-$  and with the difference between the input and reference common mode voltages. While the input drive circuit nonzero source impedance combined with the converter average input current will not degrade the INL performance, indirect distortion may result from the modulation of the offset error by the common mode component of the input signal. Thus, when using large  $C_{IN}$  capacitor values, it is advisable to carefully match the source impedance seen by the  $IN^+$  and  $IN^-$  pins. When  $F_0 = \text{LOW}$  (internal oscillator and 60Hz notch), every  $1\Omega$  mismatch in source impedance transforms a full-scale common mode input signal into a differential mode input signal of 0.023ppm. When  $F_0 = \text{HIGH}$  (internal oscillator and 50Hz

notch), every  $1\Omega$  mismatch in source impedance transforms a full-scale common mode input signal into a differential mode input signal of 0.02ppm. When  $F_0$  is driven by an external oscillator with a frequency  $f_{EOSC}$ , every  $1\Omega$  mismatch in source impedance transforms a full-scale common mode input signal into a differential mode input signal of  $0.15 \cdot 10^{-6} \cdot f_{EOSC}$  ppm. Figure 20 shows the typical offset error due to input common mode voltage for various values of source resistance imbalance between the  $IN^+$  and  $IN^-$  pins when large  $C_{IN}$  values are used.

If possible, it is desirable to operate with the input signal common mode voltage very close to the reference signal common mode voltage as is the case in the ratiometric measurement of a symmetric bridge. This configuration eliminates the offset error caused by mismatched source impedances.

The magnitude of the dynamic input current depends upon the size of the very stable internal sampling capacitors and upon the accuracy of the converter sampling clock. The accuracy of the internal clock over the entire temperature and power supply range is typical better than 0.5%. Such a specification can also be easily achieved by an external clock. When relatively stable resistors (50ppm/°C) are used for the external source impedance seen by  $IN^+$  and  $IN^-$ , the expected drift of the dynamic current, offset and

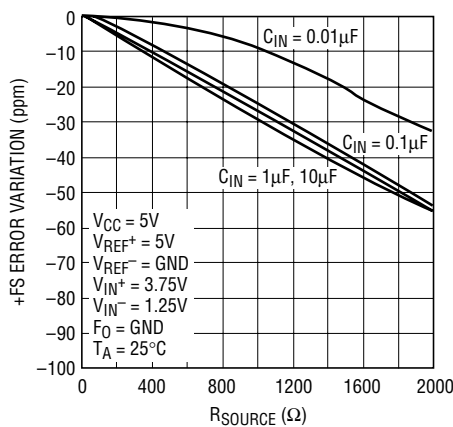

Figure 18. +FS Error vs  $R_{SOURCE}$  at  $IN^+$  or  $IN^-$  (Large  $C_{IN}$ )

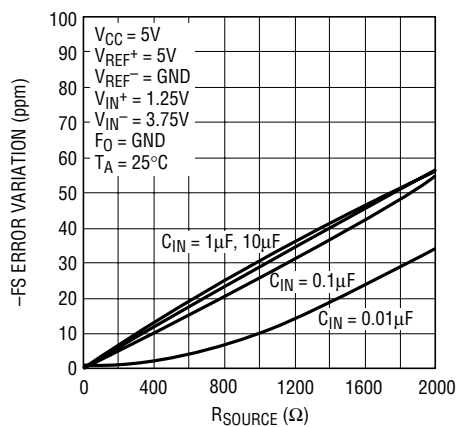

Figure 19. -FS Error vs  $R_{SOURCE}$  at  $IN^+$  or  $IN^-$  (Large  $C_{IN}$ )

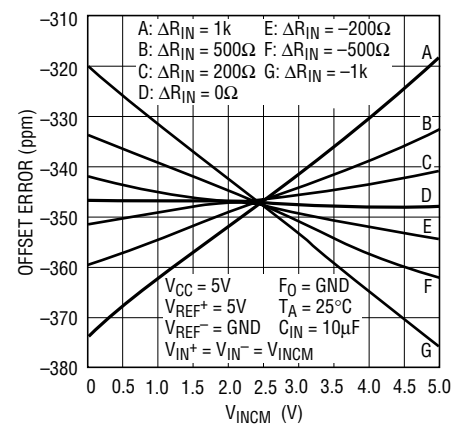

Figure 20. Offset Error vs Common Mode Voltage ( $V_{INCM} = V_{IN^+} = V_{IN^-}$ ) and Input Source Resistance Imbalance ( $\Delta R_{IN} = R_{SOURCEIN^+} - R_{SOURCEIN^-}$ ) for Large  $C_{IN}$  Values ( $C_{IN} \geq 1\mu F$ )



## APPLICATIONS INFORMATION

gain errors will be insignificant (about 1% of their respective values over the entire temperature and voltage range). Even for the most stringent applications, a one-time calibration operation may be sufficient.

In addition to the input sampling charge, the input ESD protection diodes have a temperature dependent leakage current. This current, nominally 1nA ( $\pm 10$ nA max), results in a small offset shift. A 100 $\Omega$  source resistance will create a 0.1 $\mu$ V typical and 1 $\mu$ V maximum offset voltage.

### Reference Current

In a similar fashion, the LTC2435/LTC2435-1 sample the differential reference pins REF<sup>+</sup> and REF<sup>-</sup> transferring small amount of charge to and from the external driving circuits thus producing a dynamic reference current. This current does not change the converter offset, but it may degrade the gain and INL performance. The effect of this current can be analyzed in the same two distinct situations.

For relatively small values of the external reference capacitors ( $C_{REF} < 0.01\mu$ F), the voltage on the sampling capacitor settles almost completely and relatively large values for the source impedance result in only small errors. Such values for  $C_{REF}$  will deteriorate the converter offset and gain performance without significant benefits of reference filtering and the user is advised to avoid them.

Larger values of reference capacitors ( $C_{REF} > 0.01\mu$ F) may be required as reference filters in certain configurations. Such capacitors will average the reference sampling charge and the external source resistance will see a quasi constant reference differential impedance. For the LTC2435, when  $F_0 = \text{LOW}$  (internal oscillator and 60Hz notch), the typical differential reference resistance is 15.6M $\Omega$  which will generate a +FS gain error of approximately 0.032ppm for each ohm of source resistance driving REF<sup>+</sup> or REF<sup>-</sup>. When  $F_0 = \text{HIGH}$  (internal oscillator and 50Hz notch), the typical differential reference resistance is 18.7M $\Omega$  which will generate a +FS gain error of approximately 0.027ppm for each ohm of source resistance driving REF<sup>+</sup> or REF<sup>-</sup>. For the LTC2435-1, the typical differential reference resistance is 17.1M $\Omega$  which will generate a +FS gain error of approximately 0.029ppm for each ohm of source resistance driving REF<sup>+</sup> or REF<sup>-</sup>. When  $F_0$  is driven by an external oscillator with a frequency  $f_{EQSC}$  (external conversion clock operation), the typical differential reference resistance is  $2.4 \cdot 10^{12}/f_{EQSC}\Omega$  and each ohm of source resistance driving REF<sup>+</sup> or REF<sup>-</sup> will result in  $0.21 \cdot 10^{-6} \cdot f_{EQSC}$ ppm +FS gain error. The effect of the source resistance on the two reference pins is additive with respect to this gain error. The typical +FS and -FS errors for various combinations of source resistance seen by the REF<sup>+</sup> and REF<sup>-</sup> pins and external capacitance  $C_{REF}$  connected to these pins are shown in Figures 21, 22, 23 and 24.

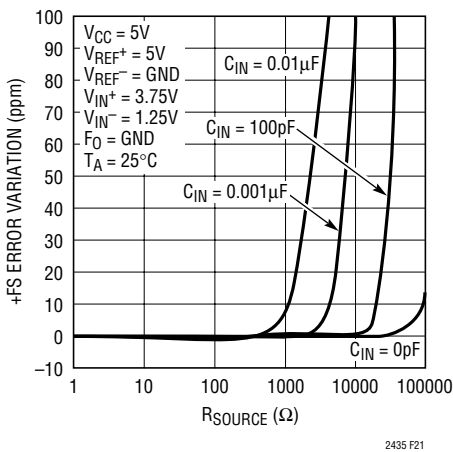

Figure 21. +FS Error vs  $R_{SOURCE}$  at REF<sup>+</sup> or REF<sup>-</sup> (Small  $C_{IN}$ )

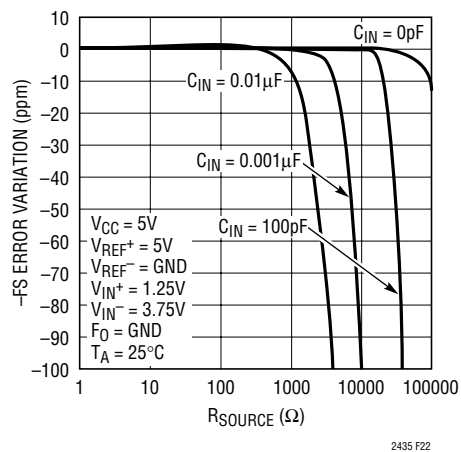

Figure 22. -FS Error vs  $R_{SOURCE}$  at REF<sup>+</sup> or REF<sup>-</sup> (Small  $C_{IN}$ )

## APPLICATIONS INFORMATION

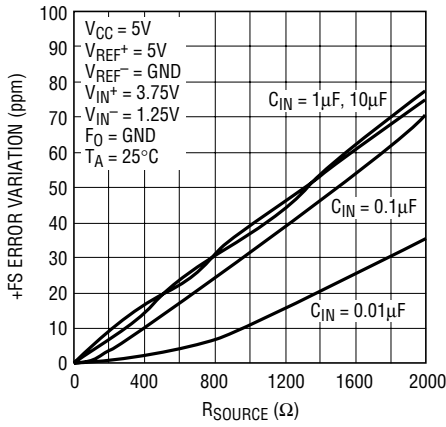

Figure 23. +FS Error vs  $R_{SOURCE}$  at  $REF^+$  and  $REF^-$  (Large  $C_{REF}$ )

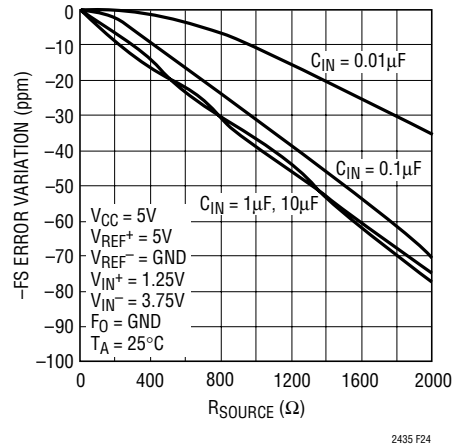

Figure 24. -FS Error vs  $R_{SOURCE}$  at  $REF^+$  and  $REF^-$  (Large  $C_{REF}$ )

In addition to this gain error, the converter INL performance is degraded by the reference source impedance. When  $F_O = LOW$  (internal oscillator and 60Hz notch), every  $100\Omega$  of source resistance driving  $REF^+$  or  $REF^-$  translates into about 0.11 ppm additional INL error. For the LTC2435, when  $F_O = HIGH$  (internal oscillator and 50Hz notch), every  $100\Omega$  of source resistance driving  $REF^+$  or  $REF^-$  translates into about 0.092 ppm additional INL error; and for the LTC2435-1 operating with simultaneous 50Hz/60Hz rejection, every  $100\Omega$  of source resistance leads to an additional 0.10 ppm of additional INL error. When  $F_O$  is driven by an external oscillator with a frequency  $f_{EOSC}$ , every  $100\Omega$  of source resistance driving  $REF^+$  or  $REF^-$  translates into about  $0.73 \cdot 10^{-6} \cdot f_{EOSC}$  ppm additional INL error. Figure 25 shows the typical INL error due to the source resistance driving the  $REF^+$  or  $REF^-$  pins when large  $C_{REF}$  values are used. The effect of the source resistance on the two reference pins is additive with respect to this INL error. In general, matching of source impedance for the  $REF^+$  and  $REF^-$  pins does not help the gain or the INL error. The user is thus advised to minimize the combined source impedance driving the  $REF^+$  and  $REF^-$  pins rather than to try to match it.

The magnitude of the dynamic reference current depends upon the size of the very stable internal sampling capacitors and upon the accuracy of the converter sampling clock. The accuracy of the internal clock over the entire temperature and power supply range is typical better than 0.5%. Such a specification can also be easily achieved by

an external clock. When relatively stable resistors (50ppm/°C) are used for the external source impedance seen by  $REF^+$  and  $REF^-$ , the expected drift of the dynamic current gain error will be insignificant (about 1% of its value over the entire temperature and voltage range). Even for the most stringent applications a one-time calibration operation may be sufficient.

In addition to the reference sampling charge, the reference pins ESD protection diodes have a temperature dependent leakage current. This leakage current, nominally 1nA ( $\pm 10$ nA max), results in a small gain error. A  $100\Omega$  source resistance will create a  $0.05\mu V$  typical and  $0.5\mu V$  maximum full-scale error.

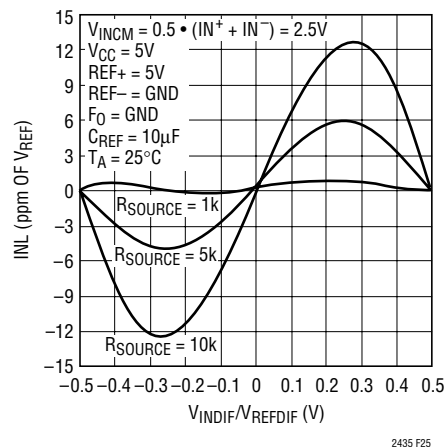

Figure 25. INL vs Differential Input Voltage ( $V_{IN} = IN^+ - IN^-$ ) and Reference Source Resistance ( $R_{SOURCE}$  at  $REF^+$  and  $REF^-$  for Large  $C_{REF}$  Values ( $C_{REF} \geq 1\mu F$ ))



## APPLICATIONS INFORMATION

### Output Data Rate

When using its internal oscillator, the LTC2435 can produce up to 15 readings per second with a notch frequency of 60Hz ( $F_0 = \text{LOW}$ ) and 12.5 readings per second with a notch frequency of 50Hz ( $F_0 = \text{HIGH}$ ) and the LTC2435-1 can produce up to 13.6 readings per second with  $F_0 = \text{LOW}$ . The actual output data rate will depend upon the length of the sleep and data output phases which are controlled by the user and which can be made insignificantly short. When operated with an external conversion clock ( $F_0$  connected to an external oscillator), the LTC2435/LTC2435-1 output data rate can be increased as desired. The duration of the conversion phase is  $10278/f_{\text{EOSC}}$ . If  $f_{\text{EOSC}} = 153600\text{Hz}$ , the converter behaves as if the internal oscillator is used and the notch is set at 60Hz. There is no significant difference in the LTC2435/LTC2435-1 performance between these two operation modes.

An increase in  $f_{\text{EOSC}}$  over the nominal 153600Hz will translate into a proportional increase in the maximum output data rate. This substantial advantage is nevertheless accompanied by three potential effects, which must be carefully considered.

First, a change in  $f_{\text{EOSC}}$  will result in a proportional change in the internal notch position and in a reduction of the converter differential mode rejection at the power line frequency. In many applications, the subsequent performance degradation can be substantially reduced by relying upon the LTC2435/LTC2435-1's exceptional common mode rejection and by carefully eliminating common mode to differential mode conversion sources in the input circuit. The user should avoid single-ended input filters and should maintain a very high degree of matching and symmetry in the circuits driving the  $\text{IN}^+$  and  $\text{IN}^-$  pins.

Second, the increase in clock frequency will increase proportionally the amount of sampling charge transferred through the input and the reference pins. If large external input and/or reference capacitors ( $C_{\text{IN}}$ ,  $C_{\text{REF}}$ ) are used, the previous section provides formulae for evaluating the effect of the source resistance upon the converter performance for any value of  $f_{\text{EOSC}}$ . If small external input and/or reference capacitors ( $C_{\text{IN}}$ ,  $C_{\text{REF}}$ ) are used, the effect of the external source resistance upon the LTC2435/LTC2435-1 typical performance can be inferred from Figures 16, 17, 21 and 22 in which the horizontal axis is scaled by  $153600/f_{\text{EOSC}}$ .

Third, the internal analog circuits are optimized for normal operation; therefore an increase in the frequency of the external oscillator will start to decrease the effectiveness of the internal analog circuits. This will result in a progressive degradation in the converter accuracy and linearity. Typical measured performance curves for output data rates up to 200 readings per second are shown in Figures 26 to 33. The degradation becomes more obvious above output data rate of 150Hz, which corresponds to an external oscillator of 1.536MHz. In order to obtain the highest possible level of accuracy from this converter at output data rates above 150 readings per second, the user is advised to maximize the power supply voltage used and to limit the maximum ambient operating temperature. In certain circumstances, a reduction of the differential reference voltage may be beneficial.

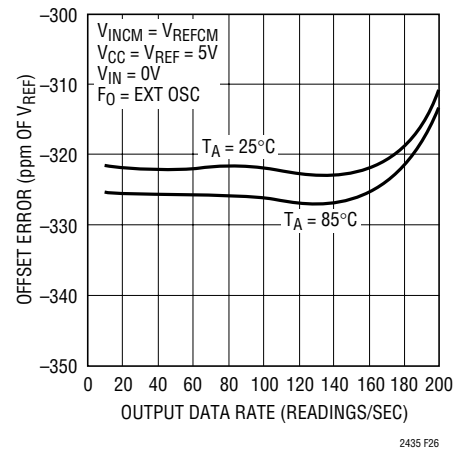

Figure 26. Offset Error vs Output Data Rate and Temperature

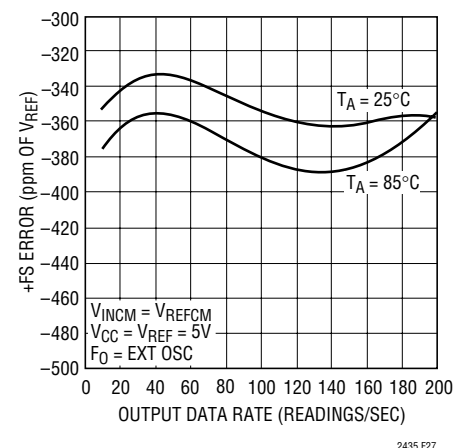

Figure 27. +FS Error vs Output Data Rate and Temperature

# APPLICATIONS INFORMATION

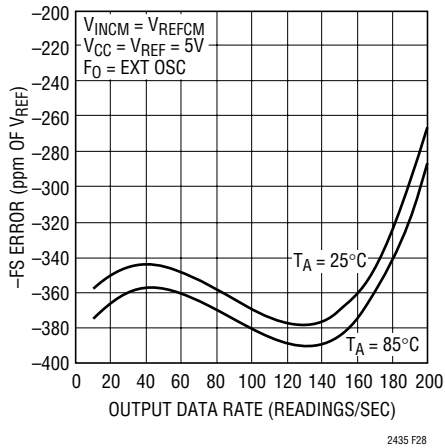

Figure 28. -FS Error vs Output Data Rate and Temperature

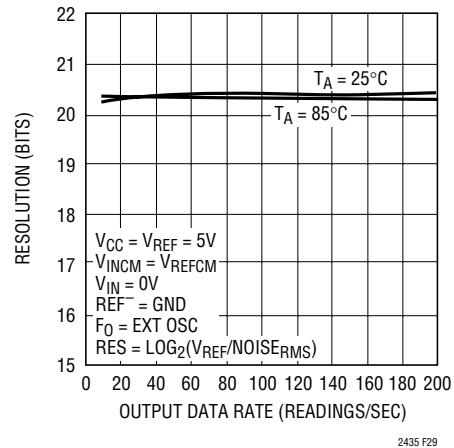

Figure 29. Resolution ( $Noise_{RMS} \leq 1LSB$ ) vs Output Data Rate and Temperature

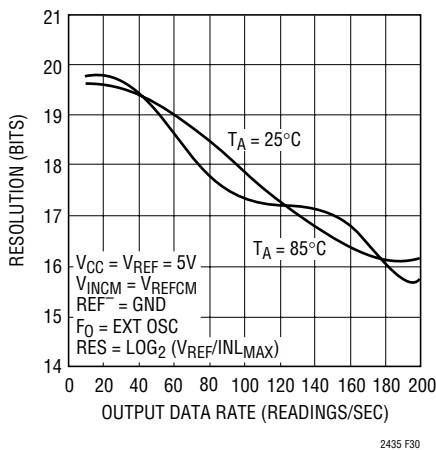

Figure 30. Resolution ( $INL_{RMS} \leq 1LSB$ ) vs Output Data Rate and Temperature

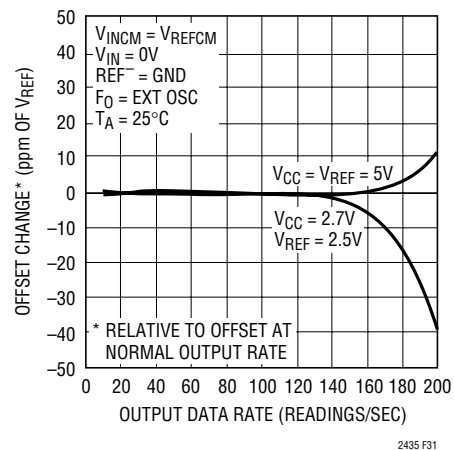

Figure 31. Offset Change\* vs Output Data Rate and Reference Voltage

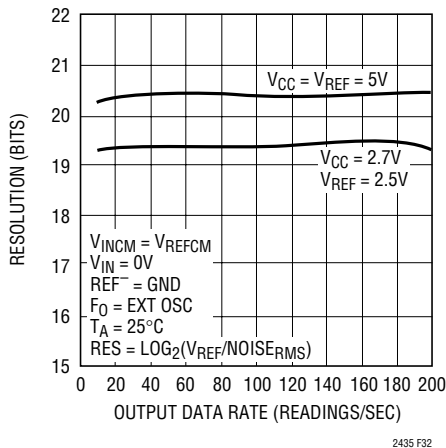

Figure 32. Resolution ( $Noise_{RMS} \leq 1LSB$ ) vs Output Data Rate and Reference Voltage

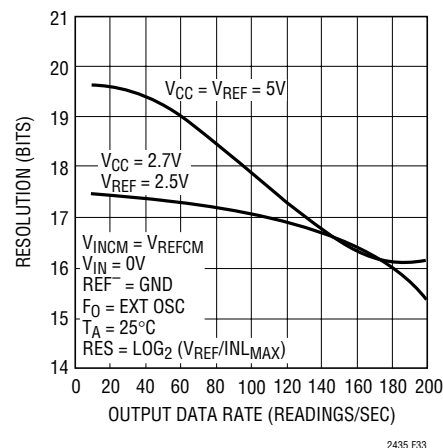

Figure 33. Resolution ( $INL_{MAX} \leq 1LSB$ ) vs Output Data Rate and Reference Voltage

## APPLICATIONS INFORMATION

### Normal Mode Rejection and Antialiasing

One of the advantages delta-sigma ADCs offer over conventional ADCs is on-chip digital filtering. Combined with a large oversampling ratio, the LTC2435/LTC2435-1 significantly simplifies antialiasing filter requirements.

The sinc<sup>4</sup> digital filter provides greater than 120dB normal mode rejection at all frequencies except DC and integer multiples of the modulator sampling frequency ( $f_S$ ). Independent of the operating mode,  $f_S = 256 \cdot f_N = 1024 \cdot f_{OUTMAX}$  where  $f_N$  is the notch frequency and  $f_{OUTMAX}$  is the maximum output data rate. In the internal oscillator mode, for the LTC2435,  $F_S = 12800\text{Hz}$  with a 50Hz notch setting and  $f_S = 15360\text{Hz}$  with a 60Hz notch setting. For the LTC2435-1,  $f_S = 13980\text{Hz}$  ( $F_0 = \text{LOW}$ ). In the external oscillator mode,  $f_S = f_{EOSC}/10$ .

The normal mode rejection performance is shown in Figure 34. The regions of low rejection occurring at integer multiples of  $f_S$  have a very narrow bandwidth. Magnified details of the normal mode rejection curves are shown in Figure 35 (rejection near DC) and Figure 36 (rejection at  $f_S = 256f_N$ ) where  $f_N$  represents the notch frequency. For the LTC2435, the bandwidth is 13.6Hz ( $F_0 = \text{GND}$ ) and 11.4Hz ( $F_0 = V_{CC}$ ). The Bandwidth is 12.4Hz for the LTC2435-1 ( $F_0 = \text{GND}$ ).

Through  $F_0$  connection, the LTC2435 provides better than 110dB input differential mode rejection at 50Hz or 60Hz  $\pm 2\%$ . While for the LTC2435-1, it has a notch frequency of about 55Hz with better than 70db rejection over 48Hz to 62.4Hz, which covers both 50Hz  $\pm 2\%$  and 60Hz  $\pm 2\%$ . In order to achieve better rejection over the range of 48Hz to 62.4Hz, a running average can be performed. By averaging two consecutive LTC2435-1 readings, a sinc<sup>1</sup> notch is combined with the sinc<sup>4</sup> digital filter, yielding the frequency response shown in Figure 37. The averaging operation still keeps the output rate with the following algorithm:

Result 1 = average (sample 0, sample 1)

Result 2 = average (sample 1, sample 2)

Result n = average (sample n-1, sample n)

The user can expect to achieve in practice this level of performance using the internal oscillator as it is demonstrated by Figures 38 to 40. Typical measured values of the normal mode rejection of the LTC2435-1 operating with an internal oscillator and a 54.6Hz notch setting are shown in Figure 38 and 39 superimposed over the theoretical calculated curve. The same normal mode rejection performance is obtained for the LTC2435 with the frequency scaled to have the notch frequency at 60Hz ( $F_0 = \text{GND}$ ) or 50Hz ( $F_0 = V_{CC}$ ).

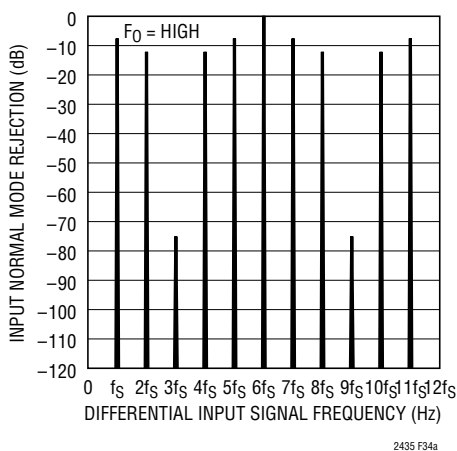

Figure 34a. Input Normal Mode Rejection, Internal Oscillator and 50Hz Notch (LTC2435)

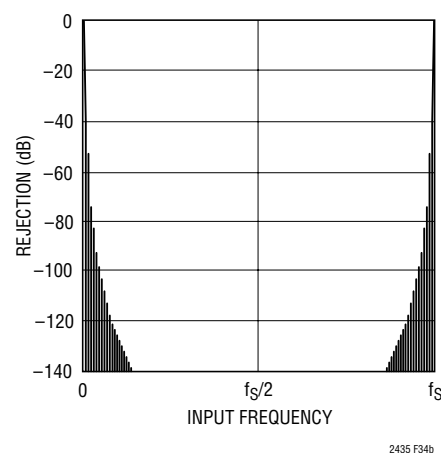

Figure 34b. Input Normal Mode Rejection, Internal Oscillator and  $F_0 = \text{Low}$  or External Oscillator

## APPLICATIONS INFORMATION

As a result of these remarkable normal mode specifications, minimal (if any) antialias filtering is required in front of the LTC2435/LTC2435-1. If passive RC components are placed in front of the LTC2435/LTC2435-1, the input dynamic current should be considered (see Input Current section). In cases where large effective RC time constants are used, an external buffer amplifier may be required to minimize the effects of dynamic input current.

Traditional high order delta-sigma modulators, while providing very good linearity and resolution, suffer from potential instabilities at large input signal levels. The proprietary architecture used for the LTC2435/LTC2435-1 third order modulator resolves this problem and guarantees a predictable stable behavior at input signal levels of up to 150% of full scale. In many industrial applications, it is not uncommon to have to measure microvolt level signals superimposed over volt level perturbations and LTC2435/LTC2435-1 are eminently suited for such tasks. When the perturbation is differential, the specification of interest is the normal mode rejection for large input signal levels. With a reference voltage  $V_{REF} = 5V$ , the LTC2435/LTC2435-1 have a full-scale differential input range of 5V peak-to-peak. Figure 40 shows measurement results for the LTC2435-1 normal mode rejection ratio with a 7.5V peak-to-peak (150% of full scale) input signal superim-

posed over the more traditional normal mode rejection ratio results obtained with a 5V peak-to-peak (full scale) input signal. The same performance is obtained for the LTC2435 with the frequency scaled to have the notch frequency at 60Hz ( $F_0 = GND$ ) or 50Hz ( $F_0 = V_{CC}$ ). It is clear that the LTC2435/LTC2435-1 rejection performance is maintained with no compromises in this extreme situation. When operating with large input signal levels, the user must observe that such signals do not violate the device absolute maximum ratings.

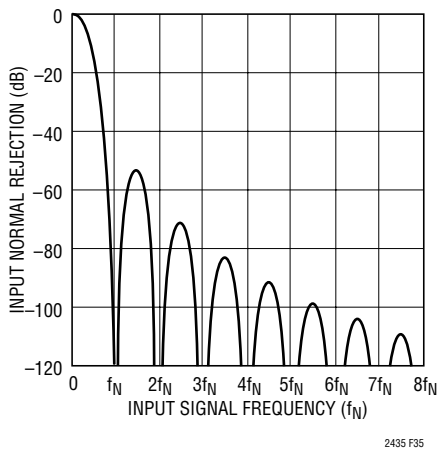

Figure 35. Input Normal Mode Rejection

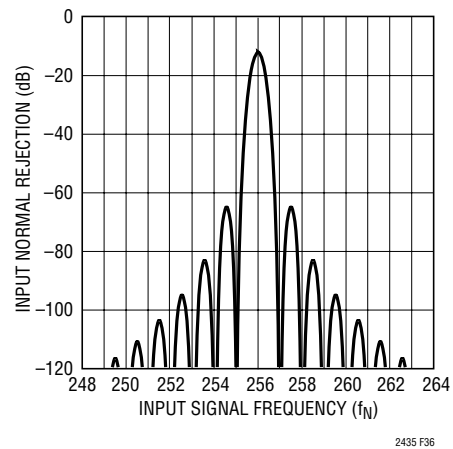

Figure 36. Input Normal Mode Rejection

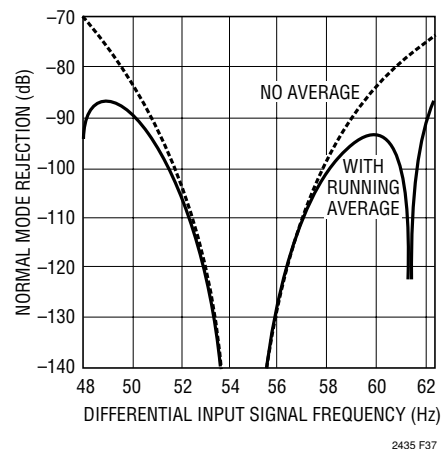
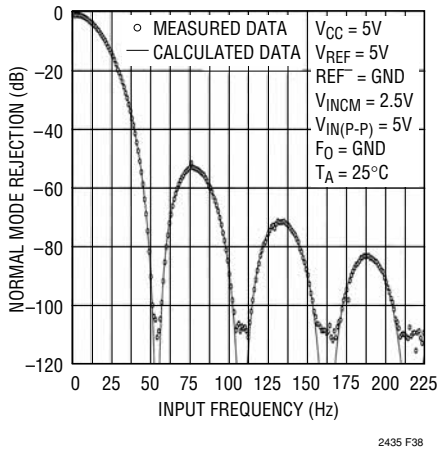
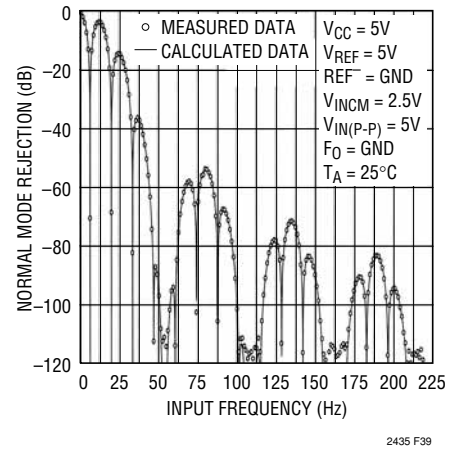

Figure 37. LTC2435-1 Input Normal Mode Rejection

## APPLICATIONS INFORMATION



**Figure 38. Input Normal Mode Rejection vs Input Frequency (LTC2435-1)**



**Figure 39. Input Normal Mode Rejection vs Input Frequency with Running Average**

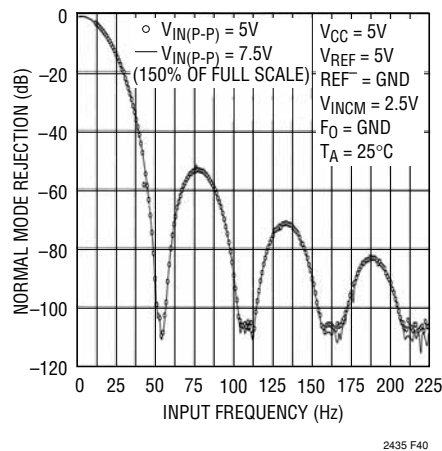

**Figure 40. Measured Input Normal Mode Rejection vs Input Frequency ( $f_N = 54.6\text{Hz}$ )**





## APPLICATIONS INFORMATION

```
// Basic data collection program for the LTC2435 using the
// PIC16F73 microcontroller. Collects data as fast as possible
// and sends it out the serial port at 57600 baud as six
// hexadecimal characters, followed by a carriage return.
// This can be captured with a terminal program and analyzed
// with a spreadsheet using the HEX2DEC function (in Excel.)
//
// Written for the CCS compiler, version 3.049.
////////////////////////////////////

#include <16F73.h>

#define SSPCON 0x14 // Synchronous serial port control
#define SSPSTAT 0x94 // registers.
#define CKE SSPSTAT.6
#define CKP SSPCON.4
#define SSPEN SSPCON.5
#define HS_NOWDT_PUT
#define delay(clock=10000000) // For baud rate calculation.

#define rs232(baud=57600,parity=N,xmit=PIN_C6,rcv=PIN_C7)
// Serial data is sent on pin C6.
#define CS_PIN_C2 // Chip select connected to pin C2
#define CLOCK_PIN_C // Clock connected to pin C3
#define SDO_PIN_C4 // SDO on the LTC2435 connected to pin C4
// (this is SDI on the PIC;
// Master In, Slave Out (MISO) is less ambiguous)

void main() {

    // Basic configuration, no bearing on operation of LTC2435
    setup_adc_ports(NO_ANALOGS);
    setup_adc(ADC_CLOCK_DIV_2);
    setup_counters(RTCC_INTERNAL,RTCC_DIV_2);
    setup_timer_1(T1_DISABLED);
    setup_timer_2(T2_DISABLED,0,1);
    setup_ccp1(CCP_OFF);
    setup_ccp2(CCP_OFF);

    // LTC2435 is connected to the processor's hardware SPI port.
    // This sets the port such that data is shifted on clock falling edges and
    // valid on rising edges. For a 10 MHz master clock, the SPI clock frequency
    // will be 2.5 MHz.
    setup_spi(SPI_MASTER|SPI_L_TO_HI|SPI_CLK_DIV_4|SPI_SS_DISABLED);
    CKP = 0; // Set up clock edges - clock idles low, data changes on
    CKE = 1; // falling edges, valid on rising edges.
```

## APPLICATIONS INFORMATION

```
while(1)
{
output_low(CS_);           // Enable LTC2435
while(input(SDO)) { /* Wait for SDO to fall, indicating end of conversion. */ }
printf("%2X",spi_read(0)); // Read first byte, send 2 hex characters.
printf("%2X",spi_read(0)); // Read second byte, send 2 hex characters.
printf("%2X",spi_read(0)); / Read third byte, send 2 hex characters.
printf("\r");             // Send carriage return.
output_high(CS_);         // Conversion actually started after last data byte was read,
                          // but raising CS_ ensures the loop will never lock up waiting for
                          // a low on SDO if a clock pulse is missed for some reason.
}
}
```

**Figure 43. A Sample Program for Data Collection from the LTC2435/LTC2435-1 Using the PIC16F73 Microcontroller.**

## APPLICATIONS INFORMATION

### Correlated Double Sampling with the LTC2435/LTC2435-1

The Typical Application on the back page of this data sheet shows the LTC2435/LTC2435-1 in a correlated double sampling circuit that achieves a noise floor of under 100nV. In this scheme, the polarity of the bridge is alternated every other sample and the result is the average of a pair of samples of opposite sign. This technique has the benefit of canceling any fixed DC error components in the bridge, amplifiers and the converter, as these will alternate in polarity relative to the signal. Offset voltages and currents, thermocouple voltages at junctions of dissimilar metals and the lower frequency components of 1/f noise are virtually eliminated.

The LTC2435/LTC2435-1 have the virtue of being able to digitize an input voltage that is outside the range defined by the reference, thereby providing a simple means to implement a ratiometric example of correlated double sampling.

This circuit uses a bipolar amplifier (LT1219—U1 and U2) that has neither the lowest noise nor the highest gain. It does, however, have an output stage that can effectively suppress the conversion spikes from the LTC2435/LTC2435-1. The LT1219 is a C-Load™ stable amplifier that, by design, needs at least 0.1μF output capacitance to remain stable. The 0.1μF ceramic capacitors at the outputs (C1 and C2) should be placed and routed to minimize lead inductance or their effectiveness in preventing envelope detection in the input stage will be reduced. Alternatively, several smaller capacitors could be placed so that lead inductance is further reduced. This is a consideration because the frequency content of the conversion spikes extends to 50MHz or more. The output impedance of most op amps increases dramatically with frequency but the effective output impedance of the LT1219 remains

low, determined by the ESR and inductance of the capacitors above 10MHz. The conversion spikes that remain at the output of other bipolar amplifiers pass through the feedback network and often overdrive the input of the amplifier, producing envelope detection. RFI may also be present on the signal lines from the bridge; C3 and C4 provide RFI suppression at the signal input, as well as suppressing transient voltages during bridge commutation.

The wideband noise density of the LT1219 is  $33\text{nV}/\sqrt{\text{Hz}}$ , seemingly much noisier than the lowest noise amplifiers. However, in the region just below the 1/f corner that is not well suppressed by the correlated double sampling, the average noise density is similar to the noise density of many low noise amplifiers. If the amplifier is rolled off below about 1500Hz, the total noise bandwidth is determined by the converter's Sinc<sup>4</sup> filter at about 12Hz. The use of correlated double sampling involves averaging even numbers of samples; hence, in this situation, two samples would be averaged to give an input-referred noise level of about 100nV<sub>RMS</sub>.

Level shift transistors Q4 and Q5 are included to allow excitation voltages up to the maximum recommended for the bridge. In the case shown, if a 10V supply is used, the excitation voltage to the bridge is 8.5V and the outputs of the bridge are above the supply rail of the ADC. U1 and U2 are also used to produce a level shift to bring the outputs within the input range of the converter. This instrumentation amplifier topology does not require well-matched resistors in order to produce good CMRR. However, the use of R2 requires that R3 and R6 match well, as the common mode gain is approximately -12dB. If the bridge is composed of four equal 350Ω resistors, the differential component associated with mismatch of R3 and R6 is nearly constant with either polarity of excitation and, as with offset, its contribution is canceled.

**PACKAGE DESCRIPTION**

**GN Package**  
**16-Lead Plastic SSOP (Narrow .150 Inch)**  
 (Reference LTC DWG # 05-08-1641)

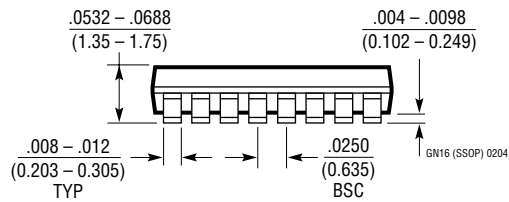
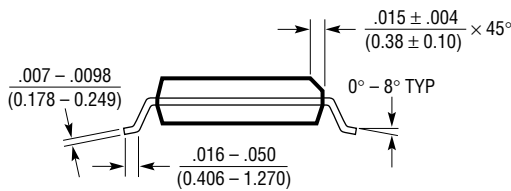
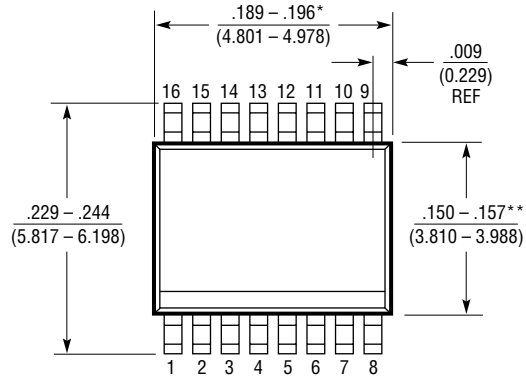
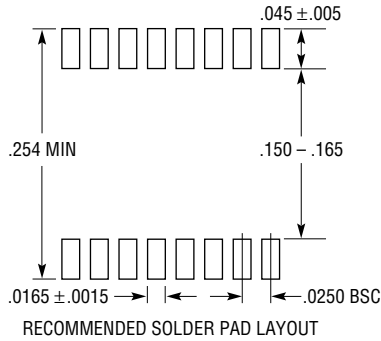

- NOTE:
1. CONTROLLING DIMENSION: INCHES
  2. DIMENSIONS ARE IN  $\frac{\text{INCHES}}{\text{(MILLIMETERS)}}$
  3. DRAWING NOT TO SCALE
- \* DIMENSION DOES NOT INCLUDE MOLD FLASH. MOLD FLASH SHALL NOT EXCEED 0.006" (0.152mm) PER SIDE
- \*\* DIMENSION DOES NOT INCLUDE INTERLEAD FLASH. INTERLEAD FLASH SHALL NOT EXCEED 0.010" (0.254mm) PER SIDE

## TYPICAL APPLICATION

### Correlated Double Sampling Resolves 100nV

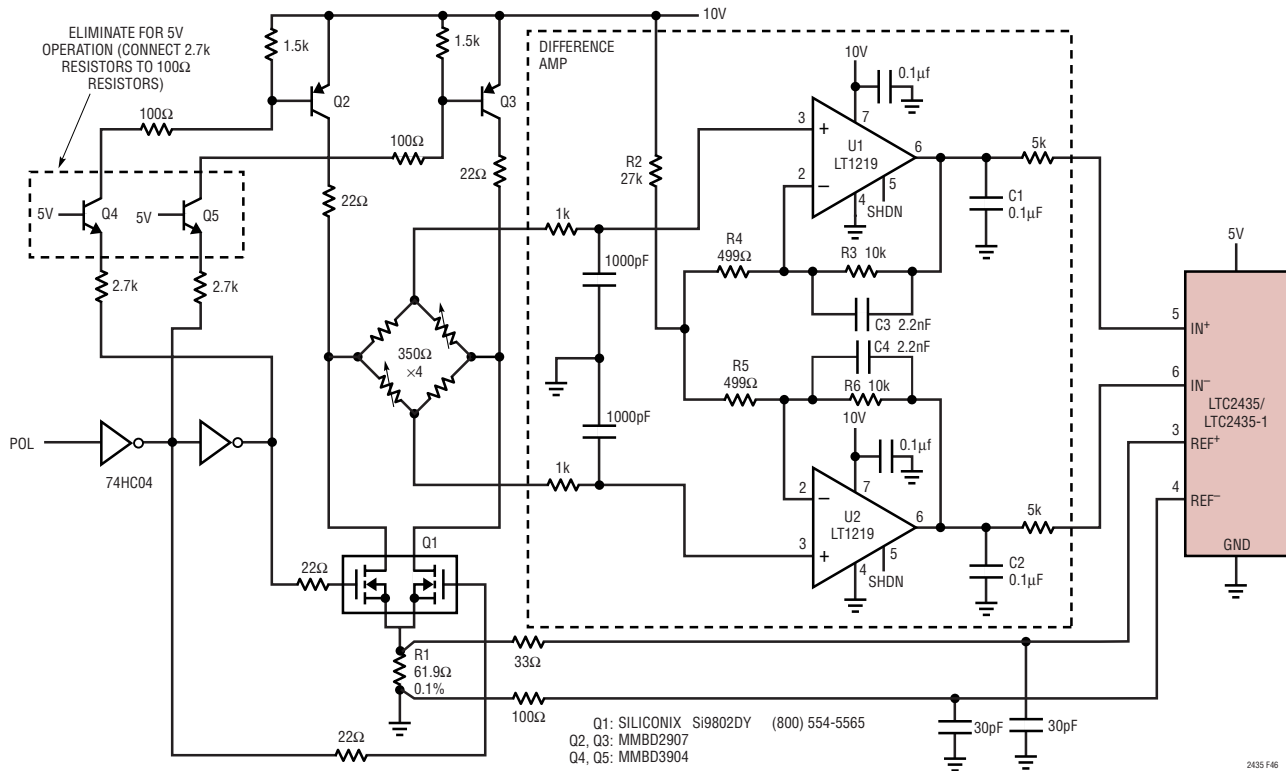

## RELATED PARTS

PART NUMBER	DESCRIPTION	COMMENTS
LT1019	Precision Bandgap Reference, 2.5V, 5V	3ppm/°C Drift, 0.05% Max Initial Accuracy
LT1025	Micropower Thermocouple Cold Junction Compensator	80μA Supply Current, 0.5°C Initial Accuracy
LTC1043	Dual Precision Instrumentation Switched Capacitor Building Block	Precise Charge, Balanced Switching, Low Power
LTC1050	Precision Chopper Stabilized Op Amp	No External Components 5μV Offset, 1.6μV <sub>p-p</sub> Noise
LT1236A-5	Precision Bandgap Reference, 5V	0.05% Max Initial Accuracy, 5ppm/°C Drift
LT1460	Micropower Series Reference	0.075% Max Initial Accuracy, 10ppm/°C Max Drift,
LTC2400	24-Bit, No Latency ΔΣ ADC in SO-8	0.3ppm Noise, 4ppm INL, 10ppm Total Unadjusted Error, 200μA
LTC2401/LTC2402	1-/2-Channel, 24-Bit, No Latency ΔΣ ADCs in MSOP	0.6ppm Noise, 4ppm INL, 10ppm Total Unadjusted Error, 200μA
LTC2404/LTC2408	4-/8-Channel, 24-Bit, No Latency ΔΣ ADCs with Differential Inputs	0.3ppm Noise, 4ppm INL, 10ppm Total Unadjusted Error, 200μA
LTC2410	24-Bit, No Latency ΔΣ ADC with Differential Inputs	800nV <sub>RMS</sub> Noise, Pin Compatible with LTC2435
LTC2411/ LTC2411-1	24-Bit, No Latency ΔΣ ADC with Differential Inputs in MSOP	1.45μV <sub>RMS</sub> Noise, 4ppm INL, Simultaneous 50Hz/60Hz Rejection (LTC2411-1)
LTC2413	24-Bit, No Latency ΔΣ ADC with Differential Inputs	Simultaneous 50Hz/60Hz Rejection, 800nV <sub>RMS</sub> Noise
LTC2415/ LTC2415-1	24-Bit, No Latency ΔΣ ADC with 15Hz Output Rate	Pin Compatible with the LTC2435/LTC2435-1
LTC2414/LTC2418	8-/16-Channel 24-Bit, No Latency ΔΣ ADC	0.2ppm Noise, 2ppm INL, 3ppm Total Unadjusted Errors 200μA
LTC2420	20-Bit, No Latency ΔΣ ADC in SO-8	1.2ppm Noise, 8ppm INL, Pin Compatible with LTC2400
LTC2430/LTC2431	20-Bit, No Latency ΔΣ ADC with Differential Inputs	2.8μV Noise, SSOP-16/MSOP Package

24351fb