

# TR350M™ LEDs

## CxxxTR3547-Sxx00

### Data Sheet

Cree's TR350M LEDs are the next generation of solid-state LED emitters that combine highly efficient InGaN materials with Cree's proprietary device technology and silicon-carbide substrates to deliver superior value for the TV-backlighting and general-illumination markets. The TR350M LEDs are among the brightest in the top-view market while delivering a low forward voltage, resulting in a very bright and highly efficient solution. The metal backside allows for eutectic die attach and enables superior performance from improved thermal management. The design is optimally suited for industry-standard top-view packages.

#### FEATURES

- Rectangular LED RF Performance
  - 450 & 460 nm
    - ◇ TR-70™ - 70 mW min
- High Reliability - Eutectic, Solder Paste or Preforms Attach
- Low Forward Voltage - 3.4 Vf Typical at 50 mA
- Maximum DC Forward Current – 150 mA
- 1000-V ESD Threshold Rating
- InGaN Junction on Thermally Conductive SiC Substrate

#### APPLICATIONS

- Large LCD Backlighting
  - Television
- General Illumination
- Medium LCD Backlighting
  - Portable PCs
  - Monitors
- LED Video Displays
- White LEDs

#### CxxxTR3547-Sxx00 Chip Diagram

Top View

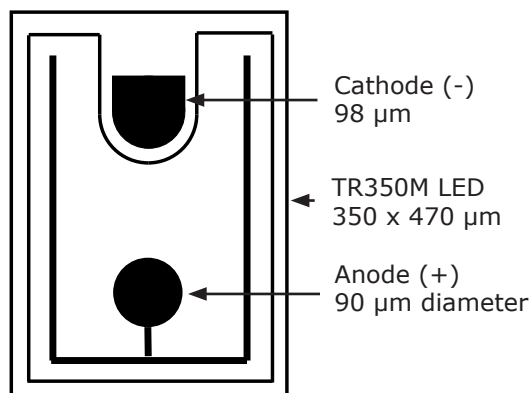

Bottom View

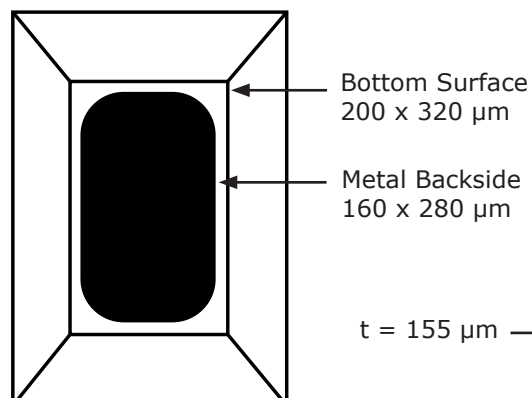

Die Cross Section

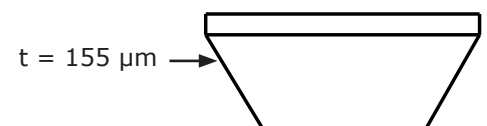



Maximum Ratings at $T_A = 25^\circ\text{C}$ <small>Notes 1&amp;3</small>		CxxxTR3547-Sxx00
DC Forward Current		150 mA
Peak Forward Current (1/10 duty cycle @ 1 kHz)		200 mA
LED Junction Temperature		150°C
Reverse Voltage		5 V
Operating Temperature Range		-40°C to +100°C
Storage Temperature Range		-40°C to +100°C
Electrostatic Discharge Threshold (HBM) <small>Note 2</small>		1000 V
Electrostatic Discharge Classification (MIL-STD-883E) <small>Note 2</small>		Class 2

Typical Electrical/Optical Characteristics at $T_A = 25^\circ\text{C}$ , $I_f = 50\text{ mA}$ <small>Note 3</small>					
Part Number	Forward Voltage ( $V_f$ , V)			Reverse Current [ $I(V_r=5V)$ , $\mu\text{A}$ ]	Full Width Half Max ( $\lambda_p$ , nm)
	Min.	Typ.	Max.	Max.	Typ.
C450TR3547-Sxx00	2.7	3.4	3.7	2	20
C460TR3547-Sxx00	2.7	3.4	3.7	2	21

Mechanical Specifications			CxxxTR3547-Sxx00
Description	Dimension	Tolerance	
P-N Junction Area ( $\mu\text{m}$ )	310 x 430	±35	
Chip Area ( $\mu\text{m}$ )	350 x 470	±35	
Chip Thickness ( $\mu\text{m}$ )	155	±15	
Au Bond Pad Diameter Anode ( $\mu\text{m}$ )	90	-5, +15	
Au Bond Pad Thicknesses ( $\mu\text{m}$ )	1.0	±0.5	
Au Bond Pad Area Cathode ( $\mu\text{m}$ )	98 x 98	-5, +15	
Bottom Area ( $\mu\text{m}$ )	200 x 320	±35	
Bottom Contact Metal ( $\mu\text{m}$ )	160 x 280	±25	
Bottom Contact Metal Thickness ( $\mu\text{m}$ )	3.0	±1.0	

**Notes:**

1. Maximum ratings are package-dependent. The above ratings were determined using a Cree 5 mm x 5 mm SMT package (with silicone encapsulation and intrinsic AuSn metal die attach) for characterization. Ratings for other packages may differ. Junction temperature should be characterized in a specific package to determine limitations. Assembly processing temperature must not exceed 325°C (< 5 seconds).
2. Product resistance to electrostatic discharge (ESD) according to the HBM is measured by simulating ESD using a rapid avalanche energy test (RAET). The RAET procedures are designed to approximate the maximum ESD ratings shown.
3. All products conform to the listed minimum and maximum specifications for electrical and optical characteristics when assembled and operated at 50 mA within the maximum ratings shown above. Efficiency decreases at higher currents. Typical values given are within the range of average values expected by manufacturer in large quantities and are provided for information only. All measurements were made using lamps in T-1 3/4 packages (with Hysol OS4000 epoxy encapsulant and intrinsic AuSn metal die attach). Optical characteristics measured in an integrating sphere using Illuminance E.



## Standard Bins for CxxxTR3547-Sxx00

LED chips are sorted to the **radiant flux** and **dominant wavelength** bins shown. A sorted die sheet contains die from only one bin. Sorted die kit (CxxxTR3547-Sxxxx) orders may be filled with any or all bins (CxxxTR3547-xxxx) contained in the kit. All radiant flux and dominant wavelength values shown and specified are at  $I_f = 50$  mA.

### C450TR3547-S7000

Radiant Flux (mW)	88	C450TR3547-0213	C450TR3547-0214	C450TR3547-0215	C450TR3547-0216	
	82	C450TR3547-0209	C450TR3547-0210	C450TR3547-0211	C450TR3547-0212	
	76	C450TR3547-0205	C450TR3547-0206	C450TR3547-0207	C450TR3547-0208	
	70	C450TR3547-0201	C450TR3547-0202	C450TR3547-0203	C450TR3547-0204	
		445	447.5	450	452.5	455
		<b>Dominant Wavelength (nm)</b>				

### C460TR3547-S7000

Radiant Flux (mW)	88	C460TR3547-0213	C460TR3547-0214	C460TR3547-0215	C460TR3547-0216	
	82	C460TR3547-0209	C460TR3547-0210	C460TR3547-0211	C460TR3547-0212	
	76	C460TR3547-0205	C460TR3547-0206	C460TR3547-0207	C460TR3547-0208	
	70	C460TR3547-0201	C460TR3547-0202	C460TR3547-0203	C460TR3547-0204	
		455	457.5	460	462.5	465
		<b>Dominant Wavelength (nm)</b>				



## Characteristic Curves

These are representative measurements for the TR LED product. Actual curves will vary slightly for the various radiant flux and dominant wavelength bins.

### Forward Current vs. Forward Voltage

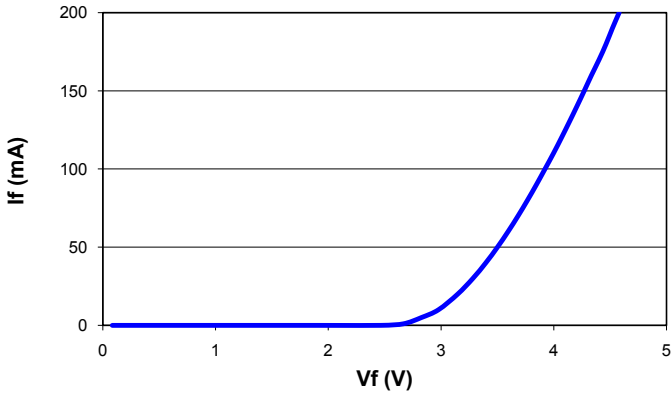

### Wavelength Shift vs. Forward Current

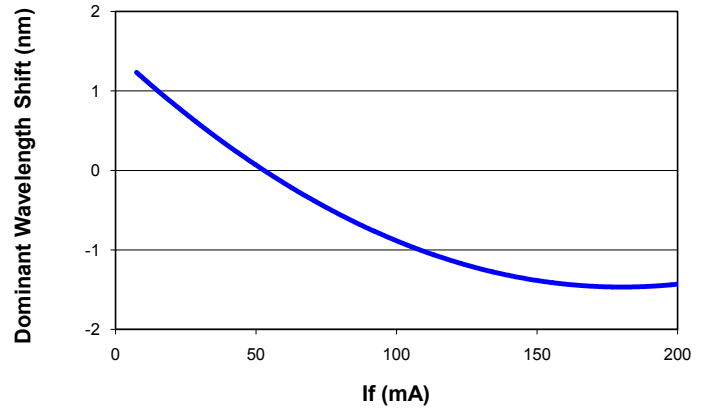

### Relative Intensity vs. Forward Current

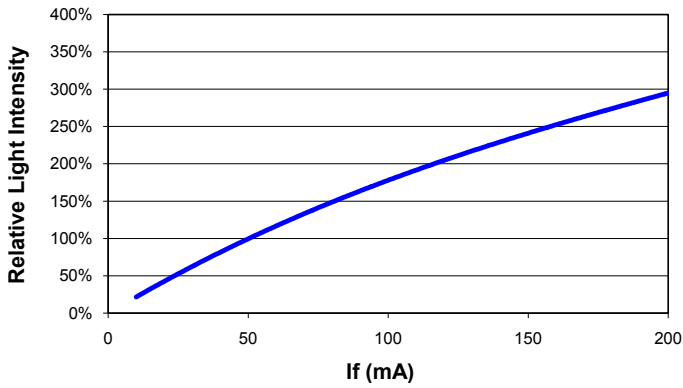

### Relative Intensity vs Peak Wavelength

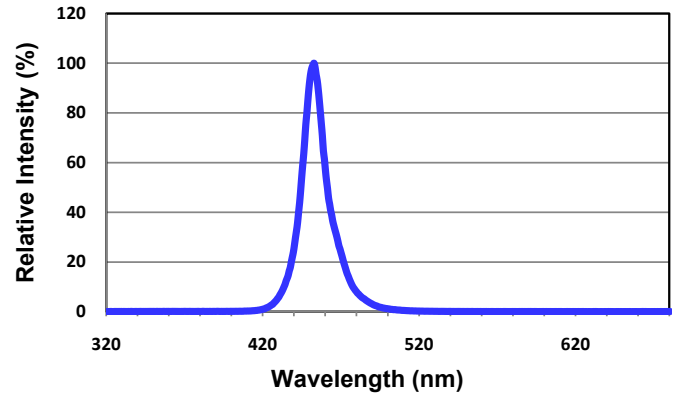

## Radiation Pattern

This is a representative radiation pattern for the TR LED product. Actual patterns will vary slightly for each chip.

