

SKiIP 35NAB12T4V1

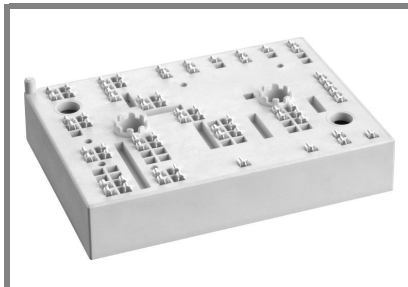

MiniSKiIP® 3

3-phase bridge rectifier +
brake chopper + 3-phase
bridge inverter
SKiIP 35NAB12T4V1

Features

- Fast Trench IGBTs
- Robust and soft freewheeling diodes in CAL technology
- Highly reliable spring contacts for electrical connections
- UL recognised file no. E63532

Remarks

- V_{CEsat} , V_F = chip level value
- product reliability results valid for $T_j \leq 150$

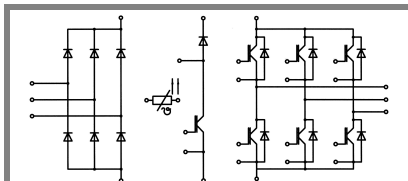

NAB

Absolute Maximum Ratings		$T_s = 25^\circ\text{C}$, unless otherwise specified	
Symbol	Conditions	Values	Units
IGBT - Inverter, Chopper			
V_{CES}	$T_s = 25 (70)^\circ\text{C}$	1200	V
I_C		67 (52)	A
I_{CRM}		150	A
V_{GES}		± 20	V
T_j		- 40 ... + 175	$^\circ\text{C}$
Diode - Inverter, Chopper			
I_F	$T_s = 25 (70)^\circ\text{C}$	60 (48)	A
I_{FRM}		150	A
T_j		- 40 ... + 175	$^\circ\text{C}$
Diode - Rectifier			
V_{RRM}	$T_s = 70^\circ\text{C}$	1600	V
I_F		61	A
I_{FSM}		700	A
i^2t		2400	A^2s
T_j		- 40 ... + 150	$^\circ\text{C}$
Module			
I_{RMS}	per power terminal (20 A / spring)	80	A
T_{stg}		- 40 ... + 125	$^\circ\text{C}$
V_{isol}	AC, 1 min.	2500	V

Characteristics		$T_s = 25^\circ\text{C}$, unless otherwise specified			
Symbol	Conditions	min.	typ.	max.	Units
IGBT - Inverter, Chopper					
V_{CEsat}	$I_{Cnom} = 50\text{ A}, T_j = 25 (150)^\circ\text{C}$		1,85 (2,25)	2,05 (2,45)	V
$V_{GE(th)}$	$V_{GE} = V_{CE}, I_C = 2\text{ mA}$	5	5,8	6,5	V
$V_{CE(TO)}$	$T_j = 25 (150)^\circ\text{C}$		0,8 (0,7)	0,9 (0,8)	V
r_T	$T_j = 25 (150)^\circ\text{C}$		21 (31)	23 (33)	m Ω
C_{ies}	$V_{CE} = 25\text{ V}, V_{GE} = 0\text{ V}, f = 1\text{ MHz}$		2,77		nF
C_{oes}	$V_{CE} = 25\text{ V}, V_{GE} = 0\text{ V}, f = 1\text{ MHz}$		0,21		nF
C_{res}	$V_{CE} = 25\text{ V}, V_{GE} = 0\text{ V}, f = 1\text{ MHz}$		0,16		nF
$R_{th(j-s)}$	per IGBT		0,71		K/W
$t_{d(on)}$	under following conditions $V_{CC} = 600\text{ V}, V_{GE} = \pm 15\text{ V}$		60		ns
t_r			35		ns
$t_{d(off)}$	$I_{Cnom} = 50\text{ A}, T_j = 150^\circ\text{C}$ $R_{Gon} = R_{Goff} = 15\ \Omega$		370		ns
t_f			60		ns
E_{on}	inductive load		6		mJ
E_{off}			4,7		mJ
Diode - Inverter, Chopper					
$V_F = V_{EC}$	$I_{Fnom} = 50\text{ A}, T_j = 25 (150)^\circ\text{C}$		2,25 (2,2)	2,55 (2,5)	V
$V_{(TO)}$	$T_j = 25 (150)^\circ\text{C}$		1,3 (0,9)	1,5 (1,1)	V
r_T	$T_j = 25 (150)^\circ\text{C}$		19 (26)	21 (28)	m Ω
$R_{th(j-s)}$	per diode		0,95		K/W
I_{RRM}	under following conditions		45		A
Q_{rr}	$I_{Fnom} = 50\text{ A}, V_R = 600\text{ V}$		8,6		μC
E_{rr}	$V_{GE} = 0\text{ V}, T_j = 150^\circ\text{C}$ $di_F/dt = 1400\text{ A}/\mu\text{s}$		3,4		mJ
Diode - Rectifier					
V_F	$I_{Fnom} = 35\text{ A}, T_j = 25^\circ\text{C}$		1,1		V
$V_{(TO)}$	$T_j = 150^\circ\text{C}$		0,8		V
r_T	$T_j = 150^\circ\text{C}$		11		m Ω
$R_{th(j-s)}$	per diode		0,9		K/W
Temperature Sensor					
R_{ts}	3 %, $T_r = 25 (100)^\circ\text{C}$		1000(1670)		Ω
Mechanical Data					
w			95		g
M_s	Mounting torque	2		2,5	Nm

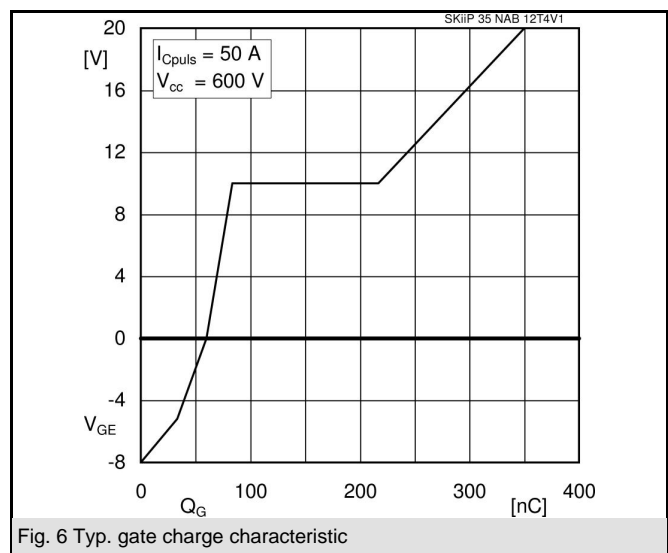
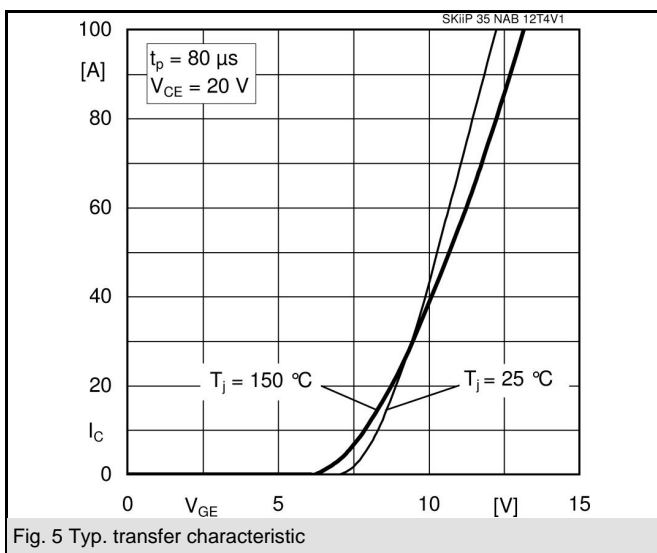
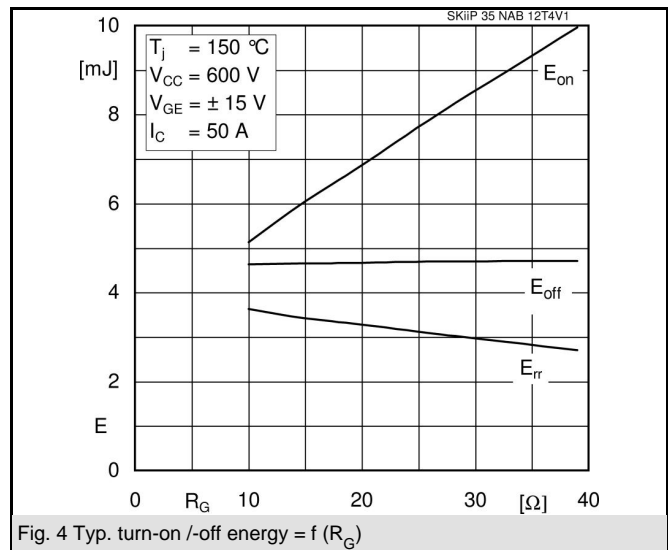
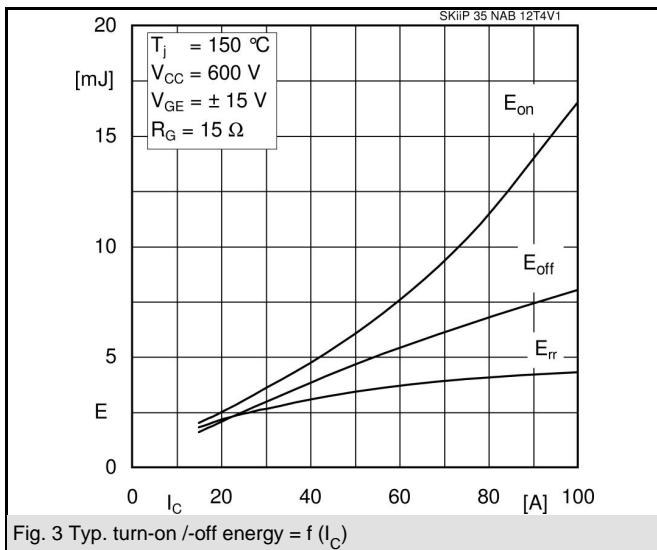
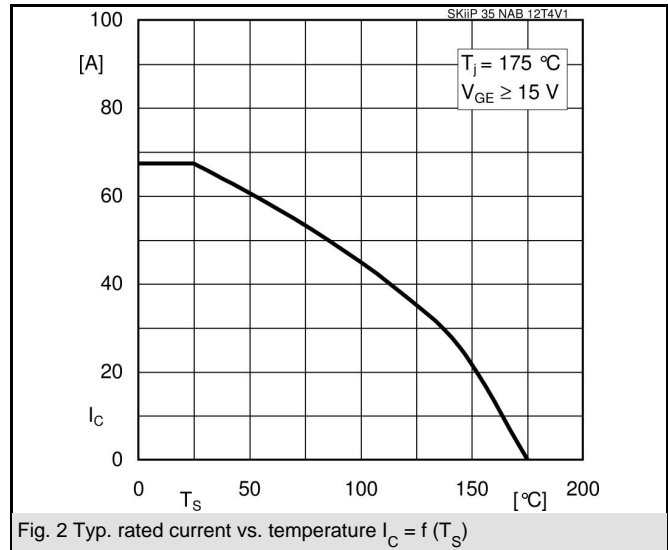
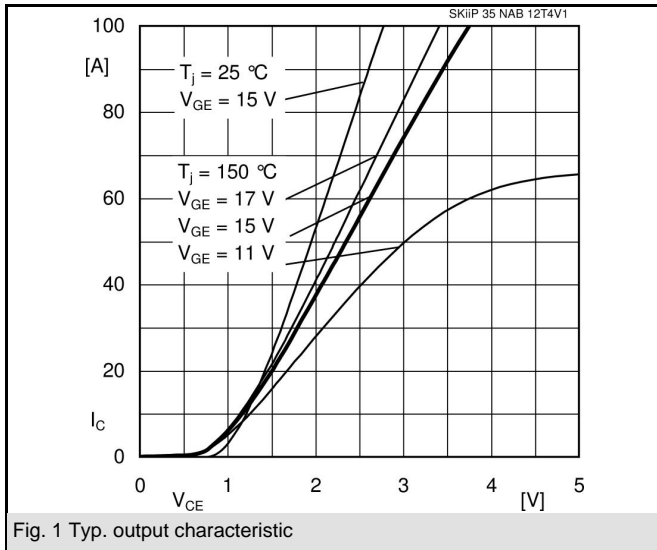

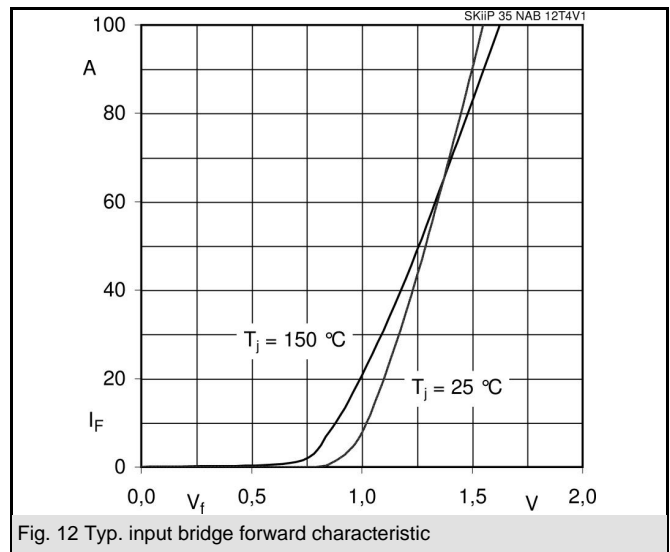
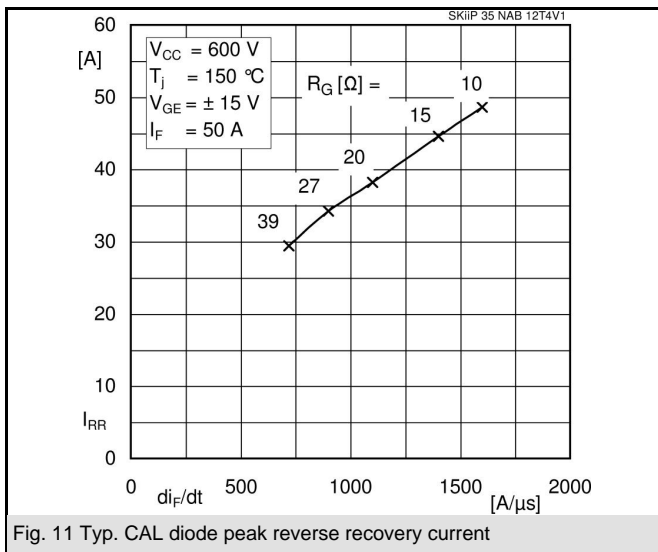
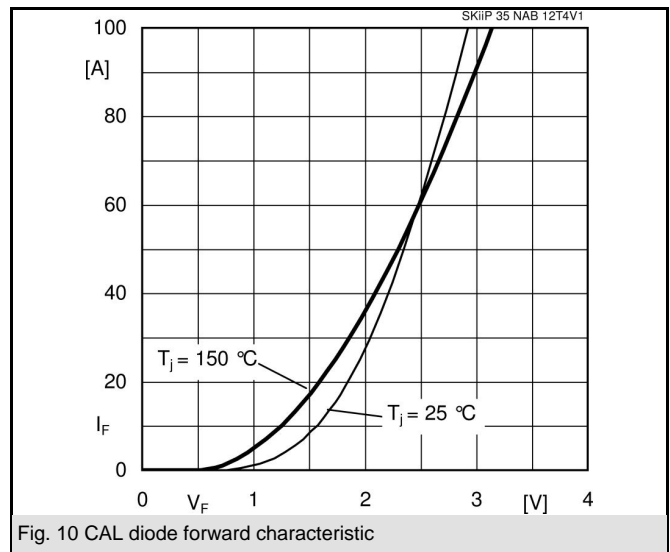
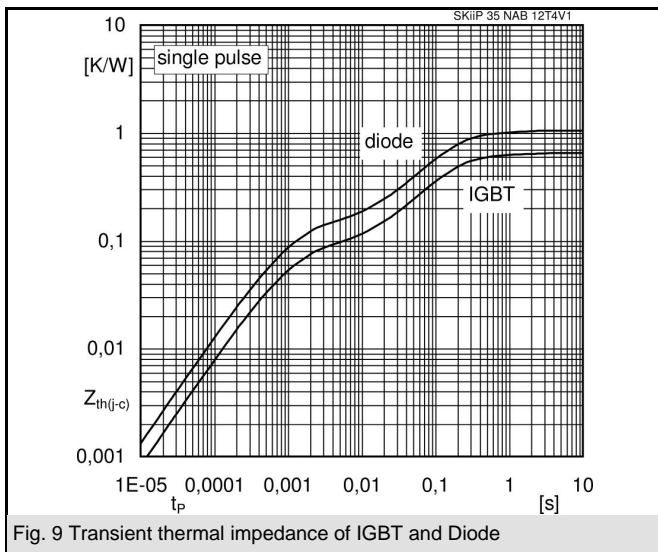
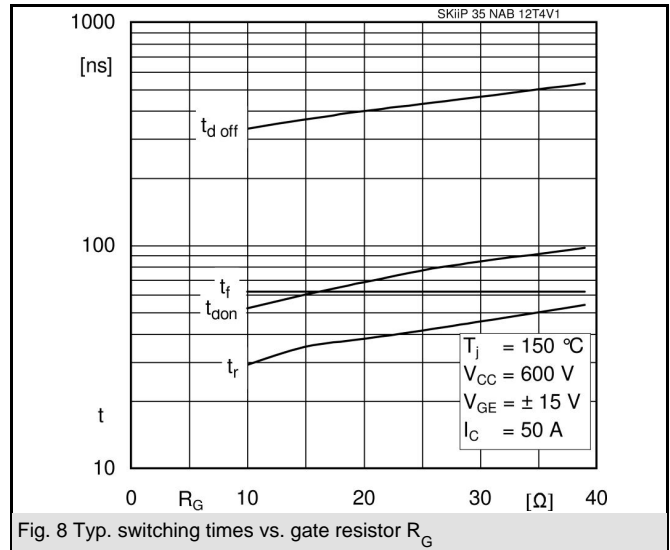
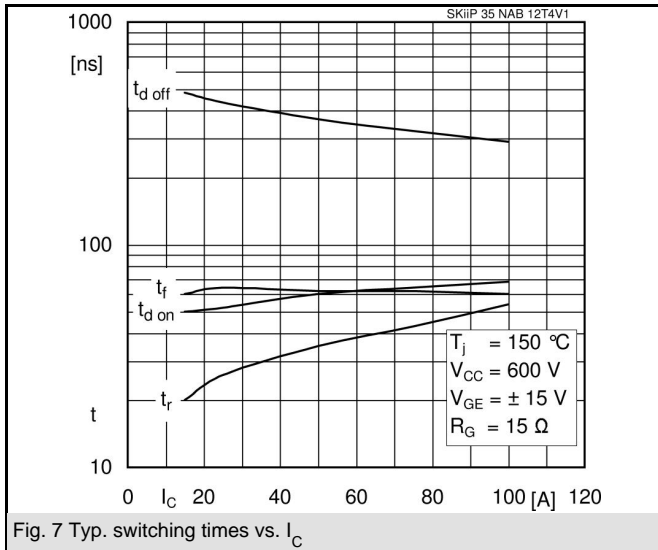

SKiiP 35NAB12T4V1

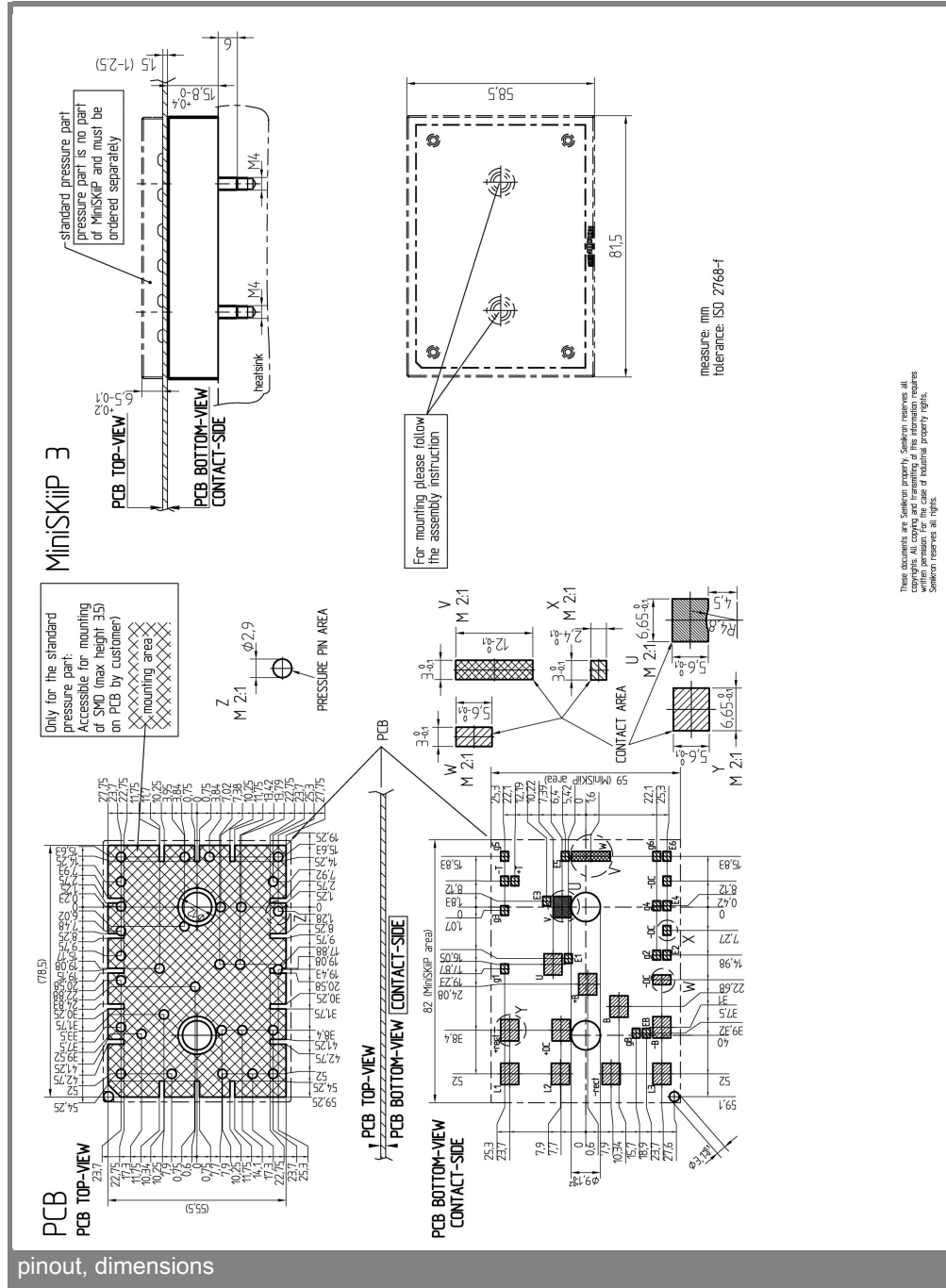
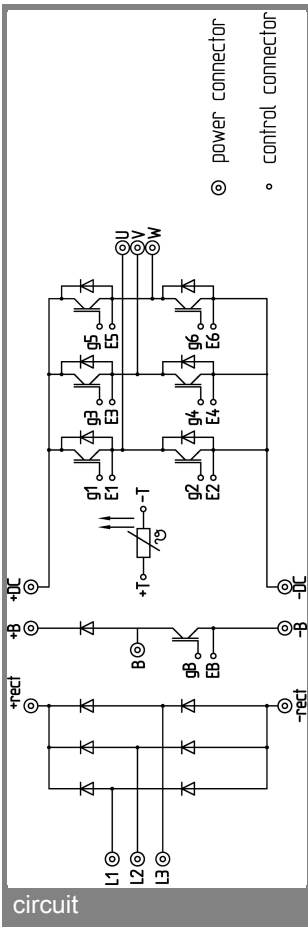

These documents are Semikron property. Semikron reserves all copyright. All copies and retransmission of this information requires written permission for the case of industrial property rights. Semikron reserves all rights.

This is an electrostatic discharge sensitive device (ESDS), international standard IEC 60747-1, Chapter IX.

This technical information specifies semiconductor devices but promises no characteristics. No warranty or guarantee expressed or implied is made regarding delivery, performance or suitability.