

USR UNR 2-T220 / T220B / T221

USS UNS 2-T220

Precision Foil Resistors

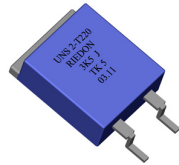

- Resistances from 0.5Ohm to 150kOhms
- Power Rating to 10Watt
- Resistance Tolerances to $\pm 0.01\%$
- TCR to $\pm 3\text{ppm/K}$
- Load Stability to 0.01%
- TO-220 Housing
- Convenient SMD D2Pak Available



SPECIFICATIONS

| Type | USR / USS | UNR / UNS |
|--|--|----------------------------|
| Resistance Range | 0.5 Ohms to 150 kOhms | 0.5 Ohms to 5 kOhms |
| Power rating free air 70°C (R<50R0) free air 70°C (R>50R0) with heatsink (R<50R0) with heatsink (R>50R0) | 1.5W 1.0W 10W 6W | 1.5W 1.0W 15W 10W |
| Thermal Resistance Rthj-c R<50R0 R>50R0 | 10.8 K/W 18.8 K/W | 6.8 K/W 10.8 K/W |
| Tolerances from 0.5 Ohms from 10.0 Ohms from 25.0 Ohms from 50.0 Ohms | 0.1% / 0.25% / 0.5% / 1% 0.05% / 0.1% / 0.25% / 0.5% / 1% 0.02% / 0.05% / 0.1% / 0.25% / 0.5% / 1% 0.01% / 0.02% / 0.05% / 0.1% / 0.25% / 0.5% / 1% | |
| Stability | 0.01% | |
| Shelf Life Stability | 25ppm / ΔR after 1 year 50ppm / ΔR after 3 year | |
| Temperature Coefficient | max. $\pm 5\text{ppm/K}$ (-55 to 155°C) typ. $\pm 3\text{ppm/K}$ (-55 to 125°C) | |
| Voltage Proof | 1 kVDC | |
| Thermal EMF | < 0.1 $\mu\text{V/K}$ | |
| Operating Temperature Range | -55 to 155°C | |
| Resistor Material | NiCr-Foil | |
| Substrate | Al ₂ O ₃ | AlN |
| Housing | Epoxy + Cu heatsink nickel plated | |
| Connector Material | Cu tinned | |
| Terminals | 2 | |
| Max. Torque | 1.0 Nm | |
| Notes | Specially designed for applications with fast changing electrical load | |

Ordering Information

Part Number - Resistance - Contact - Tolerance - TCR
UNR 2-T220B 5.7kOhms C 0.5% 3ppm

SPECIFICATIONS (continued)

Temperature Coefficient

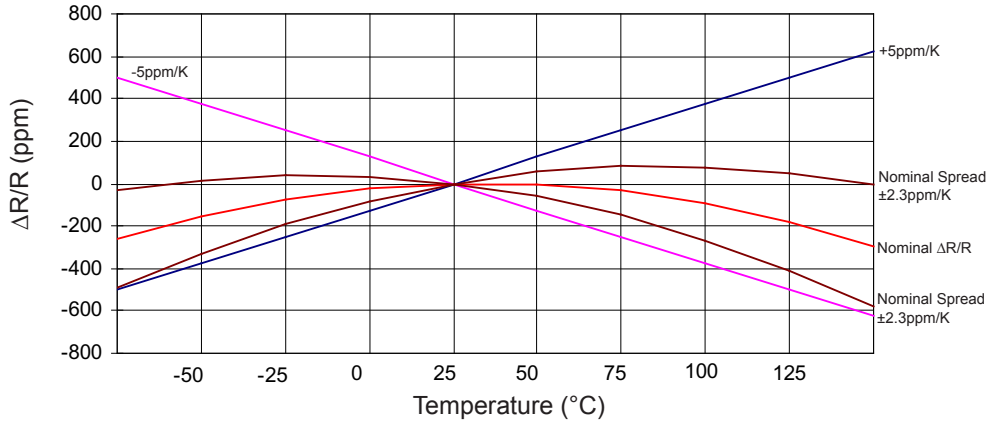

Derating

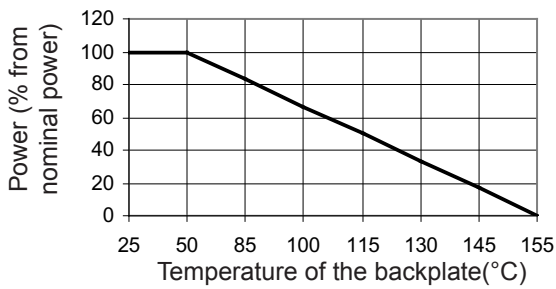

Power Rating Notes -

The U-Series Resistors must be attached to a suitable heatsink. The maximum internal resistor temperature is 155°C. To specify an appropriate heatsink use the following formula :

$$R_{\theta H} = \frac{T_{MAX} - (P \times R_{\theta R}) - T_A}{P}$$

Where: $R_{\theta H}$ = Thermal Resistance of Heatsink (K/W)
 $R_{\theta R}$ = Thermal Resistance of Resistor (K/W)
 T_{MAX} = Maximum Temperature of Resistor
 T_A = Ambient Temperature of Heatsink (°C)
 P = Power Through Resistor (W)

Dimensions

USS 2-T220 / UNS 2-T220

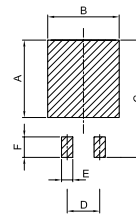
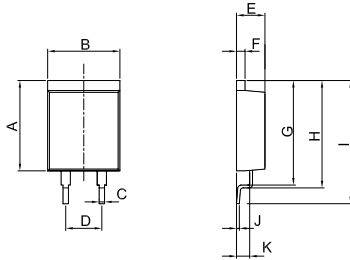

| Dimension | mm | tol. (±mm) | inches | tol. (±inches) |
|-----------|-------|------------|--------|----------------|
| A | 12.70 | 0.2 | 0.50 | 0.008 |
| B | 10.16 | 0.2 | 0.40 | 0.008 |
| C | 0.76 | 0.1 | 0.03 | 0.004 |
| D | 5.08 | 0.1 | 0.20 | 0.004 |
| E | 4.00 | 0.1 | 0.16 | 0.004 |
| F | 1.20 | 0.1 | 0.05 | 0.004 |
| G | 14.60 | 0.2 | 0.57 | 0.008 |
| H | 15.00 | 0.2 | 0.59 | 0.008 |
| I | 17.33 | 0.2 | 0.68 | 0.008 |
| J | 0.40 | 0.1 | 0.02 | 0.004 |
| K | 1.85 | 0.1 | 0.07 | 0.004 |

| Dimension | mm | inches |
|-----------|-------|--------|
| A | 12.10 | 0.476 |
| B | 11.16 | 0.439 |
| C | 18.33 | 0.722 |
| D | 5.08 | 0.200 |
| E | 1.76 | 0.069 |
| F | 3.20 | 0.126 |

SPECIFICATIONS (continued)

Dimensions

USR 2-T220B / UNR 2-T220B

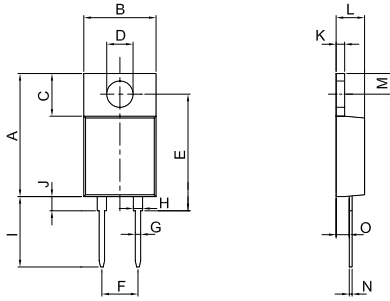

| Dimension | mm | tol. (±mm) | inches | tol. (±inches) |
|---------------|-------|------------|--------|----------------|
| A | 17.30 | 0.2 | 0.68 | 0.008 |
| B | 10.16 | 0.2 | 0.40 | 0.008 |
| C | 6.00 | 0.1 | 0.24 | 0.004 |
| D | Ø3.7 | 0.1 | Ø0.146 | 0.004 |
| E | 16.40 | 0.2 | 0.65 | 0.008 |
| F | 5.08 | 0.1 | 0.20 | 0.004 |
| G | 0.76 | 0.1 | 0.03 | 0.004 |
| H | 1.30 | 0.1 | 0.05 | 0.004 |
| I | 10.00 | 0.2 | 0.39 | 0.008 |
| I (C-Contact) | 13.80 | 0.2 | 0.54 | 0.008 |
| J | 2.00 | 0.1 | 0.08 | 0.004 |
| K | 1.20 | 0.1 | 0.05 | 0.004 |
| L | 4.00 | 0.1 | 0.16 | 0.004 |
| M | 2.90 | 0.1 | 0.11 | 0.004 |
| N | 0.40 | 0.1 | 0.02 | 0.004 |
| O | 1.85 | 0.1 | 0.07 | 0.004 |

USR 2-T221 / UNR 2-T221

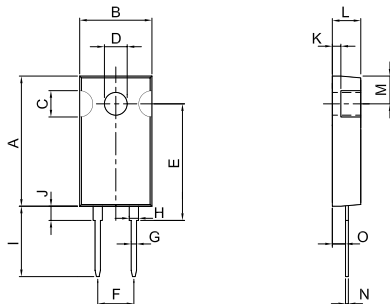

| Dimension | mm | tol. (±mm) | inches | tol. (±inches) |
|---------------|-------|------------|--------|----------------|
| A | 18.30 | 0.2 | 0.72 | 0.008 |
| B | 10.16 | 0.2 | 0.40 | 0.008 |
| C | 3.70 | 0.1 | 0.15 | 0.004 |
| D | Ø3.2 | 0.1 | Ø0.126 | 0.004 |
| E | 16.40 | 0.2 | 0.65 | 0.008 |
| F | 5.08 | 0.1 | 0.20 | 0.004 |
| G | 0.76 | 0.1 | 0.03 | 0.004 |
| H | 1.30 | 0.1 | 0.05 | 0.004 |
| I | 10.00 | 0.2 | 0.39 | 0.008 |
| I (C-Contact) | 13.80 | 0.2 | 0.54 | 0.008 |
| J | 2.00 | 0.1 | 0.08 | 0.004 |
| K | 1.20 | 0.1 | 0.05 | 0.004 |
| L | 4.00 | 0.1 | 0.16 | 0.004 |
| M | 3.90 | 0.1 | 0.15 | 0.004 |
| N | 0.40 | 0.1 | 0.02 | 0.004 |
| O | 1.85 | 0.1 | 0.07 | 0.004 |

USR 2-T220 / UNR 2-T220

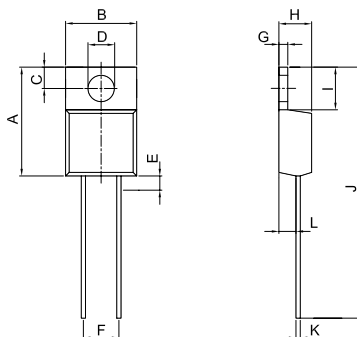

| Dimension | mm | tol. (±mm) | inches | tol. (±inches) |
|-----------|-------|------------|--------|----------------|
| A | 15.30 | 0.2 | 0.60 | 0.008 |
| B | 10.00 | 0.2 | 0.39 | 0.008 |
| C | 2.80 | 0.1 | 0.11 | 0.004 |
| D | Ø3.7 | 0.1 | Ø0.146 | 0.004 |
| E | 2.00 | 0.1 | 0.08 | 0.004 |
| F | 5.08 | 0.1 | 0.20 | 0.004 |
| G | 1.27 | 0.1 | 0.05 | 0.004 |
| H | 4.60 | 0.1 | 0.18 | 0.004 |
| I | 6.00 | 0.2 | 0.24 | 0.008 |
| J | 35.30 | 2.0 | 1.39 | 0.079 |
| K | Ø0.6 | 0.1 | Ø0.02 | 0.004 |
| L | 2.41 | 0.1 | 0.09 | 0.004 |