



Features

- Input ranges of 4.75-5.5V or 10.8-13.6V
- Output voltages of 1.8/2.5/3.3V
- 8 and 10 Amp output current models
- V_{OUT} user-trimmable from 1.28V to 3.6V
- Non-isolated, full synchronous topology
- 1" x 2" through-hole or SMT package
- Gull-wing leads for SMT package
- High efficiency to 91%; Low noise
- 200kHz switching; Planar magnetics
- -40 to +40/50/60°C ambient operation with no derating
- Remote on/off control; Output overcurrent detection
- IEC950/EN60950/UL1950 approval

As supply voltages trend lower and load currents increase, centralized power becomes more impractical. The tight accuracy, low noise and quick transient response demanded by today's low voltage CPU's, ASIC's and DSP's make power processing at the point of use the only viable solution. The UNR 18-33W series provides a complete line of non-isolated DC/DC converters to satisfy this requirement. With input voltages of 5V (-D5 models) and 12V (-D12 models) these converters offer standard output voltages of 1.8, 2.5 and 3.3 Volts and up to 10 Amps of output current in both through-hole and surface-mount 1" x 2" metal cases.

With on/off control and output voltage trim capability as standard features, these non-isolated converters exploit full synchronous rectification, planar magnetics, and 100% automated assembly to deliver high efficiencies (to 91%) and low noise at low cost.

These versatile DC/DC's are fully line and load regulated. They feature quick transient response (50µsec), user-optional on/off control (for power sequencing), and output overcurrent detection and shutdown ("hiccup" technique with auto-recovery). Their impressive guaranteed efficiencies enable them to deliver fully rated output power from -40 to +50/55°C (ambient) without supplemental cooling.

If your high current requirements have made the use of inefficient linear regulators impractical, take a look at one of Murata Power Solutions' new switching buck regulators. Their high efficiency, ease-of-use, long-term reliability, and overall cost effectiveness will impress you. Safety agency approvals and EMC characterizations are currently in progress.

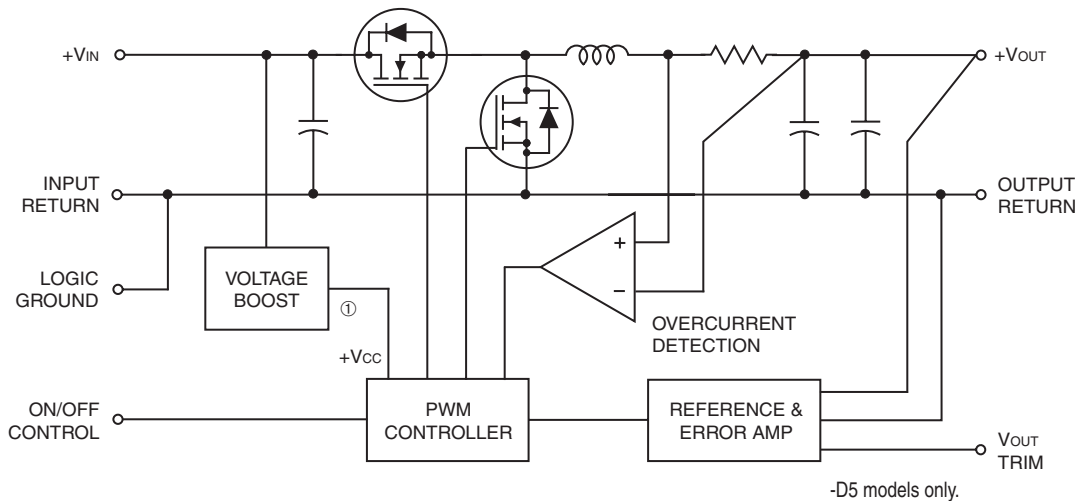

Figure 1. Simplified Schematic

-D5 models only.

Typical topology is shown.



Root Model ^⑤	Output				Input			Efficiency		Package (Case, Pinout)		
	V _{out} (Volts)	I _{out} (Amps)	R/N (mVp-p) ^②		Regulation (Max.)		V _{in} Nom. (Volts)	Range (Volts)	I _{in} ^④ (mA/MA)		Min.	Typ.
			Typ.	Max.	Line	Load ^③						
UNR-1.8/10-D5T	1.8	10	70	100	±0.1%	±0.5%	5	4.75-5.5	150/4190	82%	86%	C16A2, P23
UNR-1.8/10-D5SM	1.8	10	40	80	±0.1%	±0.5%	5	4.75-5.5	150/4190	82%	86%	C18, P25
UNR-2.5/10-D5T	2.5	10	75	100	±0.1%	±0.5%	5	4.75-5.5	150/5620	85%	89%	C16A2, P23
UNR-2.5/10-D5SM	2.5	10	75	100	±0.1%	±0.5%	5	4.75-5.5	150/5620	85%	89%	C18, P25
UNR-3.3/8-D5T	3.3	8	40	80	±0.1%	±0.5%	5	4.75-5.5	100/5470	88%	92%	C16A1, P23
UNR-3.3/8-D5SM	3.3	8	40	80	±0.1%	±0.5%	5	4.75-5.5	100/5470	88%	92%	C18, P25
UNR-3.3/8-D12T	3.3	8	40	100	±0.25%	±0.875%	12	10.8-13.6	50/2420	86%	91%	C16A1, P23
UNR-3.3/8-D12SM	3.3	8	40	100	±0.25%	±0.875%	12	10.8-13.6	50/2420	86%	91%	C18, P25
UNR-3.3/10-D5T	3.3	10	40	80	±0.1%	±0.5%	5	4.75-5.5	150/7250	86%	91%	C16A2, P23
UNR-3.3/10-D5SM	3.3	10	50	100	±0.1%	±0.5%	5	4.75-5.5	150/7250	86%	91%	C18, P25
UNR-3.3/10-D12T	3.3	10	70	120	±0.25%	±0.875%	12	10.8-13.6	90/3090	86%	89%	C16C2, P23
UNR-3.3/10-D12SM	3.3	10	70	120	±0.25%	±0.875%	12	10.8-13.6	90/3090	86%	89%	C18, P25

① Typical at T_A = +25°C under nominal line voltage and full-load conditions, unless otherwise noted. All models are tested and specified with an external 22µF output capacitor with a 200mΩ ESR and a 470µF input capacitor with 6Arms ripple-current rating and 20mΩ ESR. See I/O Filtering and Noise Reduction for more details.

② Ripple/Noise (R/N) is tested/specified over a 20MHz bandwidth. Output noise may be further reduced by installing additional external output caps. See I/O Filtering and Noise Reduction.
 ③ These devices have no minimum-load requirements and will regulate under no-load conditions.
 ④ Nominal line voltage, no-load/full-load conditions.
 ⑤ These are only partial part numbers, refer to part number structure when ordering.

MECHANICAL SPECIFICATIONS

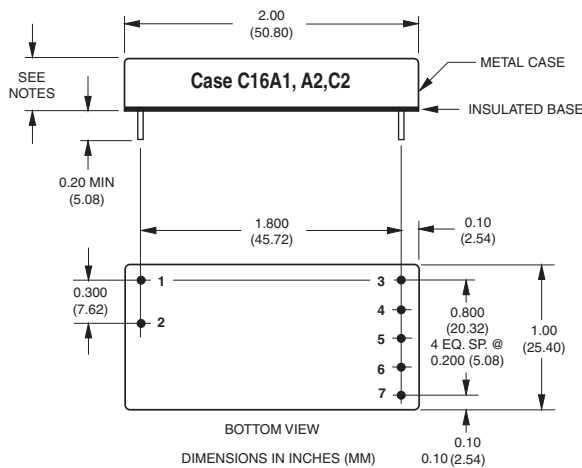

CASE C16A1
 CASE HEIGHT: 0.39 (9.91)
 PIN DIAMETERS:
 PINS 1-7: 0.040 ±0.002 (1.016 ±0.051)

CASE C16A2
 CASE HEIGHT: 0.39 (9.91)
 PIN DIAMETERS:
 PINS 1-2, 4: 0.040 ±0.002 (1.016 ±0.051)
 PINS 3, 5-7: 0.062 ±0.002 (1.575 ±0.051)

CASE C16C2
 CASE HEIGHT: 0.48 (12.19)
 PIN DIAMETERS:
 PINS 1-2, 4: 0.040 ±0.002 (1.016 ±0.051)
 PINS 3, 5-7: 0.062 ±0.002 (1.575 ±0.051)

I/O Connections		
Pin	Function P23	Function P25
1	Logic Ground	Logic Ground
2	On/Off Control	On/Off Control
3	+Output	N.C.
4	Trim	N.C.
5	Output Return	+Output
6	Input Return	Trim
7	+Input	Output Return
8	No Pin	Input Return
9	No Pin	+Input

PART NUMBER STRUCTURE

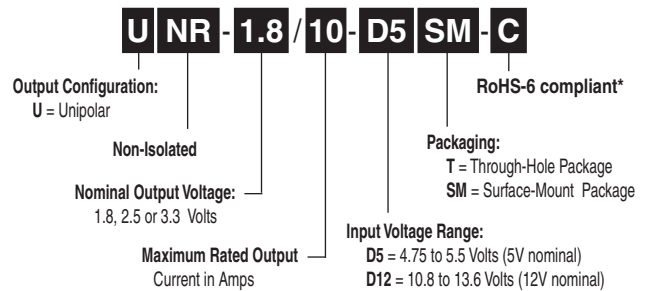

* Contact Murata Power Solutions Technologies (DATEL) for availability.

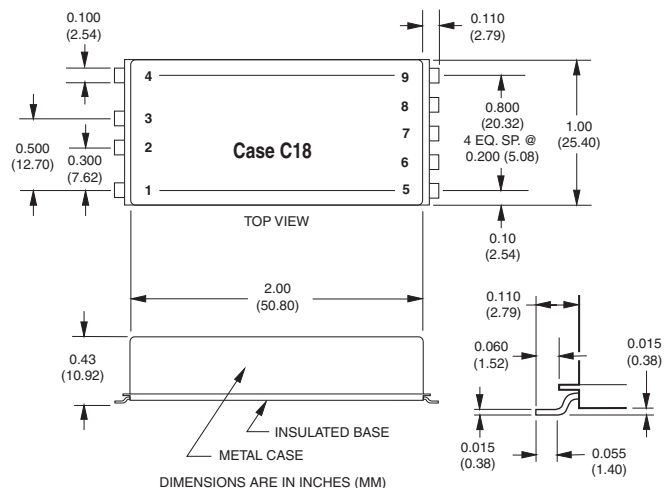

Performance/Functional Specifications

Typical @ T_A = +25°C under nominal line voltage and full-load conditions unless noted. ①

Input	
Input Voltage Range	3.0 to 3.6 Volts (3.3V nominal) D5 Models 4.75-5.5 Volts (5V nominal) D12 Models 10.8-13.6 Volts (12V nominal)
Input Current:	
Normal Operating Conditions	See Ordering Guide
Standby/Off Mode	3.6mA typical
Input Ripple Current:	
1.8/2.5V Models	150mA _{p-p}
3.3/8 -D5 Models	100mA _{p-p}
3.3/10 -D5 Models	150mA _{p-p}
3.3/8 -D12 Models	110mA _{p-p}
3.3/10 -D12 Models	250mA _{p-p}
Input Filter Type	Capacitive
Overvoltage Protection	None
Reverse-Polarity Protection	None
On/Off Control: ③	
Functionality	TTL high (or open) = on, low = off
Logic Threshold	+0.8-2.0 Volts (1.5V typical)
Output	
V_{OUT} Accuracy (50% load):	
1.8V _{OUT} Models	±2% of V _{OUT} maximum
2.5/3.3V _{OUT} Models	±1% of V _{OUT} maximum
V_{OUT} Trim Range ④	
Trim pin tied to +Output:	V _{OUT} = 1.52 Volts or less
Trim pin tied to Output Return	V _{OUT} = 3.6 Volts or greater
Temperature Coefficient	±0.02% per °C
Ripple/Noise (20MHz BW) ⑤	See Ordering Guide
Line/Load Regulation	See Ordering Guide
Efficiency	See Ordering Guide
Overcurrent Protection: ②	
Technique	"Hiccup" with auto-recovery
Overcurrent Detection Point	110-180% of rated current
Average Short Circuit Current:	
D5 Models	1 Amp typical, 3 Amps maximum
D12 Models	4 Amp typical, 6 Amps maximum
Dynamic Characteristics	
Transient Response (50-100% load):	
1.8V _{OUT} Models	100µsec to 3% of final value
1.8/2.5V _{OUT} Models	25µsec to 2.5% of final value
3.3V _{OUT} -D5 Models	50µsec to 2.5% of final value
3.3/8 -D12 Models	50µsec to 1% of final value
3.3/10 -D12 Models	50µsec to 2.5% of final value
Start-Up Time: ⑥	
V _{IN} to V _{OUT}	25/30msec (1.8/2.5V _{OUT} models)
On/Off to V _{OUT}	25/30msec (1.8/2.5V _{OUT} models)
Switching Frequency	300kHz (±30kHz)
Environmental	
Operating Temperature (Ambient): ⑦	
Without Derating	See Derating Curves
With Derating	to +100°C (See Derating Curves)
Storage Temperature	-40 to +105°C
Physical	
Dimensions:	
D5 Through-Hole Models	2" x 1" x 0.39" (51 x 25 x 9.9mm)
D5 Surface-Mount Models	2" x 1" x 0.43" (51 x 25 x 10.9mm)
D12 Through-Hole Models	2" x 1" x 0.48" (51 x 25 x 12.2mm)
D12 Surface-Mount Models	2" x 1" x TBD" (51 x 25 x 12.7mm)
Flammability	94V-0

Physical	
Shielding	5 sided
Case Connection	Input/Output Return
Case Material	Corrosion-resistant steel with non-conductive, epoxy-based, black enamel finish and plastic baseplate
Pin Material	RoHS: Gold plate over copper alloy Non-RoHS: Pure tin on copper alloy with nickel underplate

- ① All models are tested and specified with an external 470µF input capacitor with a 20mΩ ESR and a 6Arms ripple-current rating, as well as a 22µF output capacitor with a 200mΩ ESR. See I/O Filtering and Noise Reduction for more details. These devices have no minimum-load requirements and will regulate under no-load conditions. Listed specifications apply for both "T" and "SM" models as appropriate.
- ② See Output Overcurrent Detection for details.
- ③ See On/Off Control for details.
- ④ See Output Voltage Trimming for details.
- ⑤ For all models, output noise can be further reduced with the installation of additional external output capacitors. See I/O Filtering and Noise Reduction for details.
- ⑥ See Start-Up Time for details.
- ⑦ See Temperature Derating for details.

Absolute Maximum Ratings	
Input Voltage:	
Continuous:	
D5 Models	7 Volts
D12 Models	15 Volts
Transient (100msec)	15 Volts
Input Reverse-Polarity Protection	None
Input/Output Overvoltage Protection	None
Output Current	Current limited. Devices can withstand a sustained output short circuit without damage.
Storage Temperature	-40 to +105°C
Lead Temperature (Soldering, 10 sec.)	+300°C
These are stress ratings. Exposure of devices to any of these conditions may adversely affect long-term reliability. Proper operation under conditions other than those listed in the Performance/Functional Specifications Table is not implied.	

TECHNICAL NOTES

Return Current Paths

These are non-isolated DC/DC converters. The Input Return, Output Return and Logic Ground pins are all connected together internally. To the extent possible, all input and load currents should be returned through the Input Return and Output Return, respectively (via low-impedance runs). Any control signals applied to the On/Off Control pin should be referenced to Logic Ground. The internal trace leading to Logic Ground is not designed to carry high current. Consequently, devices should never be installed in a manner that results in high current flow through Logic Ground (i.e., the Input/Output Return pins should never be left open or connected via high-impedance paths).

I/O Filtering and Noise Reduction

All UNR 18-33W Series converters are tested and specified with external 470µF input capacitors (20mΩ ESR, 6Arms ripple-current rating) and external 22µF output capacitors (200mΩ ESR). External input capacitance is required and must be rated to handle the input ripple current as follows:

$$I_{RMS} = I_{OUT} \sqrt{\frac{V_{OUT}}{V_{IN}} \left(1 - \frac{V_{OUT}}{V_{IN}}\right)}$$

In critical applications, input/output ripple/noise may be further reduced by installing additional I/O caps.

Input Fusing

UNR 18-33W Series DC/DC converters are not internally fused. Certain applications and or safety agencies may require the installation of fuses at the inputs of power conversion components. For Murata Power Solutions UNR Series DC/DC converters, you should use either slow-blow or normal-blow fuses with values no greater than twice the expected input current at full power. See Ordering Guide.

Input Overvoltage and Reverse-Polarity Protection

UNR 18-33W Series DC/DC converters do not incorporate either input overvoltage or input reverse-polarity protection. Input voltages in excess of the listed absolute maximum ratings and input polarity reversals of longer than "instantaneous" duration can cause permanent damage to these devices.

On/Off Control

The On/Off Control pin may be used for remote on/off operation. UNR 18-33W Series DC/DC converters are designed so that they are enabled when the control pin is pulled high or left open (normal mode) and disabled when the control pin is pulled low (to less than +0.8V relative to Logic Ground). As shown in Figure 2, D5 models have internal 4.99kΩ pull-up resistors to V_{IN} (+Input), while D12 models have 12.4kΩ.

Dynamic control of the on/off function is best accomplished with a mechanical relay or open-collector/open-drain drive circuit (optically isolated if appropriate). The drive circuit should be able to sink appropriate current when activated and withstand appropriate voltage when deactivated.

Applying an external voltage to the On/Off Control pin when no input power is applied to the converter can cause permanent damage to the converter. The on/off control function, however, is designed such that the converter can be disabled (control pin pulled low) while input voltage is ramping up and then "released" once the input has stabilized. The time duration between the point at which the converter is released and its fully loaded output settles to within specified accuracy can be found in the Performance/Functional Specifications Table. See Start-Up Time for more details.

Start-Up Time

The V_{IN} to V_{OUT} Start-Up Time is the interval between the time at which a ramping input voltage crosses the lower limit of the specified input voltage range (4.75V for D5 models, 10.8V for D12 models) and the fully loaded output voltage enters and remains within its specified accuracy band. Actual measured times will vary with heavy capacitive loading.

The On/Off to V_{OUT} Start-Up Time assumes the converter is turned off via the Remote On/Off Control with the nominal input voltage already applied to the converter. The specification defines the interval between the time at which the converter is turned on and the fully loaded output voltage enters and remains within its specified accuracy band. See Typical Performance Curves for details

Output Overvoltage Protection

UNR 18-33W Series DC/DC converters do not incorporate output overvoltage protection. In the extremely rare situation in which the device's feedback loop is broken, the output voltage may run to excessively high levels. If it is absolutely imperative that you protect your load against any and all possible overvoltage situations, voltage limiting circuitry must be provided external to the power converter.

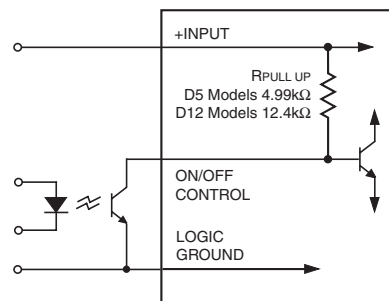

Figure 2. Driving the On/Off Control Pin

Output Overcurrent Detection

Overloading the output of a power converter for an extended period of time will invariably cause internal component temperatures to exceed their maximum ratings and eventually lead to component failure. High-current-carrying components such as transformers, FET's and diodes are at the highest risk. UNR 18-33W Series DC/DC converters incorporate an output overcurrent detection and shutdown function that serves to protect both the power converter and its load.

When the output current of a thermally stabilized converter exceeds the maximum rating by 40% (typical) to 80% (maximum), the internal overcurrent detection circuit shuts down the converter by discharging the soft-start circuit of the pulse width modulator (PWM). In this off state, which is similar to that achieved by pulling the On/Off Control low, the output voltage quickly drops as the output capacitors discharge into the load. Since there is no longer any output current, the overcurrent detection circuit is released, allowing the soft-start circuit to recharge and the converter to turn on again. If the faulty load condition persists, the overcurrent detection circuit will again discharge the soft-start circuit and shut down the converter. This continuous on/off cycling of the converter is referred to as "hiccup mode." Once the overload condition is removed, the converter remains on, and the output voltage is quickly restored to its regulated value.

The components used to sense the output current have large temperature coefficients. Consequently, in a "cold-start" situation, the Overcurrent Detection Point may temporarily move to 80% to 120% above the rated current specification. The device quickly heats up, particularly if an overload situation exists, and restores the normal (40%) Overcurrent Detection Point. The device will not be damaged by starting up into an output-short-circuit condition.

The overcurrent detection circuitry helps keep internal current levels and operating temperatures within safe operating limits. Nevertheless, sustained operation at current levels above the rated output current but below the Overcurrent Detection Point may result in permanent damage to the converter.

Output Voltage Trimming

UNR 18-33W devices can be trimmed to any voltage between 1.50V and 3.55V. Trimming is accomplished with either a trimpot or a single fixed resistor. The trimpot should be connected between +Output and Output Return with its wiper connected to the Trim pin as shown in Figure 3 below.

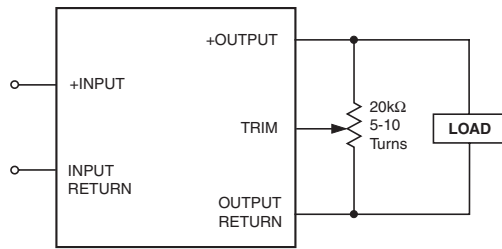
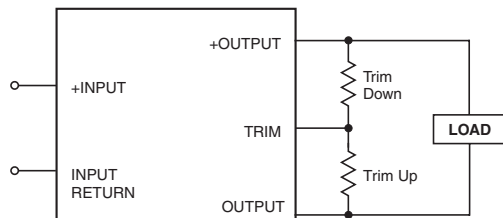

Figure 3. Trim Connections Using a Trimpot

A trimpot can be used to determine the value of a single fixed resistor which should be connected, as shown in Figure 4, between the Trim pin and +Output to trim down the output voltage, or between the Trim pin and Output Return to trim up the output voltage. Fixed resistors should be metal-film types with absolute TCR's less than 100ppm/°C to ensure stability.

The equations below can be used as starting points for selecting specific trim-resistor values. Recall that untrimmed devices are guaranteed to be between ±1% and ±2% accurate, depending on model. See Performance and Functional Specifications.



Note: Install either a fixed trim-up resistor or a fixed trim-down resistor depending upon desired output voltage.

Figure 4. Trim Connections Using Fixed Resistors

UNR-1.8/10-D5T UNR-1.8/10-D5SM	$R_{T_DOWN} (k\Omega) = \frac{2.49(V_O - 1.26)}{1.8 - V_O} - 1.74$
	$R_{T_UP} (k\Omega) = \frac{3.14}{V_O - 1.8} - 1.74$
UNR-2.5/10-D5T UNR-2.5/10-D5SM	$R_{T_DOWN} (k\Omega) = \frac{7.5(V_O - 1.26)}{2.5 - V_O} - 1.74$
	$R_{T_UP} (k\Omega) = \frac{9.47}{V_O - 2.5} - 1.74$
UNR-3.3/8-D5T UNR-3.3/8-D5SM UNR-3.3/10-D5T UNR-3.3/10-D5SM	$R_{T_DOWN} (k\Omega) = \frac{7.5(V_O - 1.27)}{3.3 - V_O} - 1.0$
	$R_{T_UP} (k\Omega) = \frac{9.5}{V_O - 3.3} - 1.0$
UNR-3.3/8-D12T UNR-3.3/8-D12SM UNR-3.3/10-D12T UNR-3.3/10-D12SM	$R_{T_DOWN} (k\Omega) = \frac{7.5(V_O - 1.26)}{3.3 - V_O} - 1.0$
	$R_{T_UP} (k\Omega) = \frac{9.41}{V_O - 3.3} - 1.0$

Note: Resistor values are in kΩ. Accuracy of adjustment is subject to tolerances of resistors and factory-adjusted output accuracy.
V_O = desired output voltage.

Recommended PC Board Layout

If necessary, a single pc board layout can accommodate both through-hole and SMT models of the UNR 18-33W Series. Note that on page 2 of this data sheet, the through-hole package is drawn with a bottom view of its pin locations, and the surface-mount package is drawn with of top view of its pin locations. As shown below, the through-hole pin locations, when viewed from above, fall just inside (on 1.8 inch centers) the SMT pin locations (which essentially begin on 2.1 inch centers). The table below shows how the pin functions align.

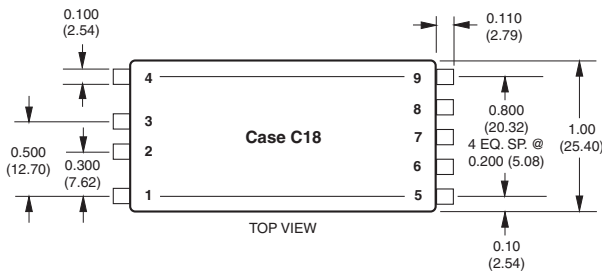
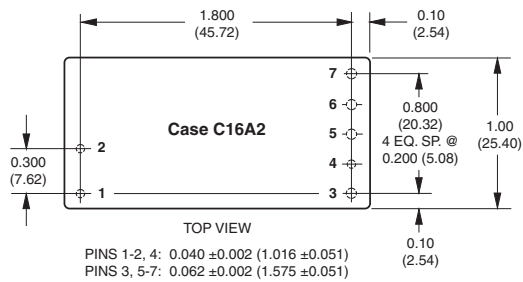

SMT Pin Number	Through-Hole Pin Number	Pin Function
4	No Pin	N.C.
3	No Pin	N.C.
2	2	On/Off Control
1	1	Logic Ground
9	7	+Input
8	6	Input Return
7	5	Output Return
6	4	Trim
5	3	+Output

Figure 5. Recommended Board Layout

SMT Solder Process for SM models

For the surface-mount "SM" models of the UNR Series, the packages' gull-wing leads are made of tin-plated (150 microinches) copper. The gull-wing configuration, as opposed to "J" leads, was selected to keep the solder joints out from under the package to minimize both, heat conduction away from the leads (into the encapsulated package) and shadowing effects.

"SM" modules do not currently withstand the standard solder-reflow process with its most common temperature profiles. In order to avoid damage to the converter a selective solder process (i.e. hot air gun or a hand soldering method) with the following parameters must therefore be chosen :

Pre-heat phase 30-60°C rise/minute to 150°C maximum.

Lead temperature 300°C for 10 seconds maximum.

As shown in Figure 6, our tests have determined the optimal landing-pad size to be 160 mils by 130 mils (4 x 3.3 mm).

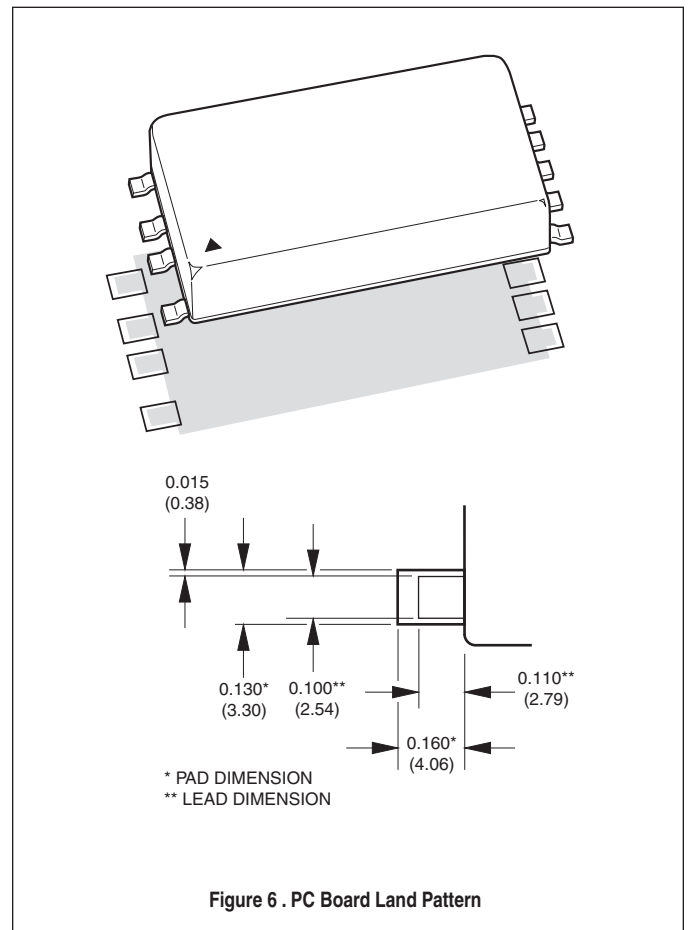

TYPICAL PERFORMANCE CURVES

V_{IN} to V_{OUT} Start-Up Time

D5 Models, Start-up from V_{IN}
(Full load, using specified output capacitor.)

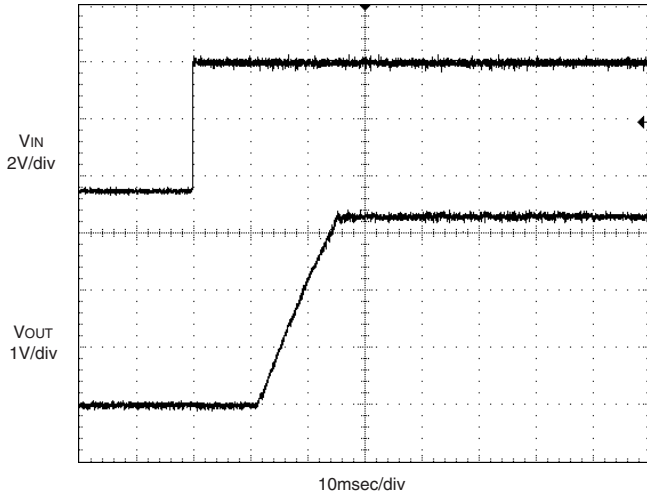

D12 Models, Start-up from V_{IN}
(Full load, using specified output capacitor.)

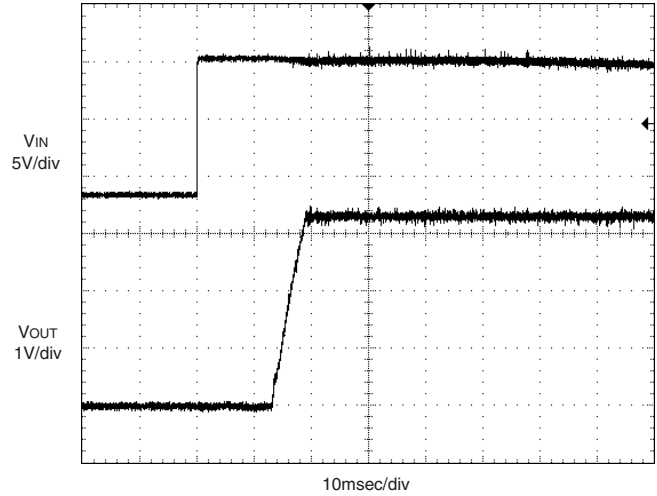

On/Off Control to V_{OUT} Start-Up Time

D5 Models, Start-up from Enable
(Full load, using specified output capacitor.)

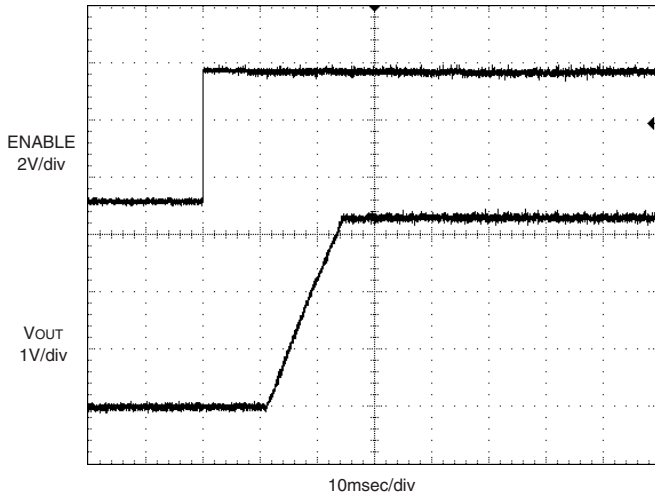

D12 Models, Start-up from Enable
(Full load, using specified output capacitor.)

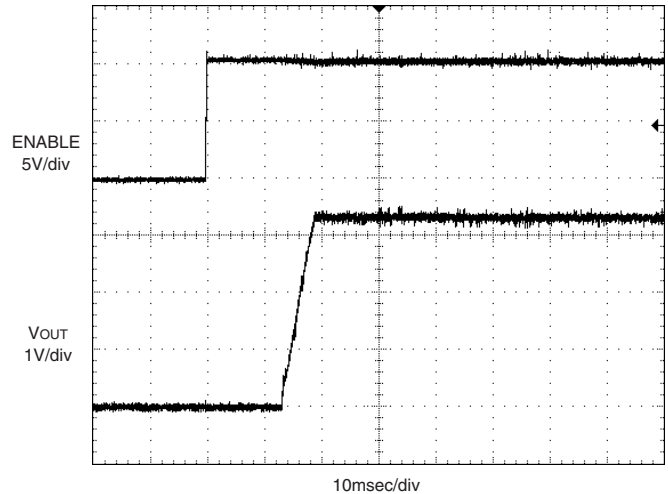

TEMPERATURE DERATING

UNR D5/D12 Series

Single Output, Non-Isolated, 5 or 12V_{IN} to 1.8/2.5/3.3V_{OUT}
8 and 10 Amp DC/DC Converters

UNR-1.8/10-D5T/D5SM Output Power vs. Ambient Temperature

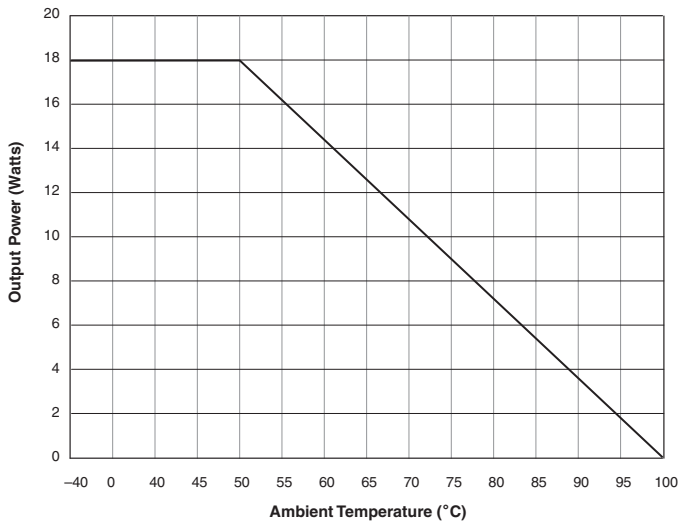

UNR-3.3/8-D12T/D12SM Output Power vs. Ambient Temperature, No Air Flow

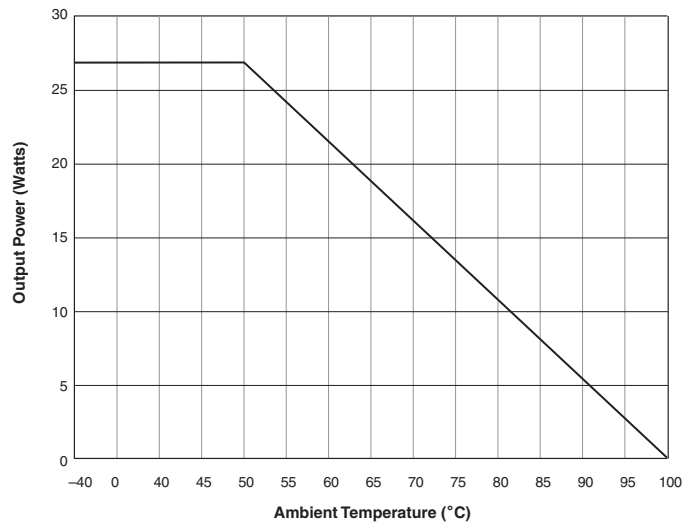

UNR-2.5/10-D5T/D5SM Output Power vs. Ambient Temperature, No Air Flow

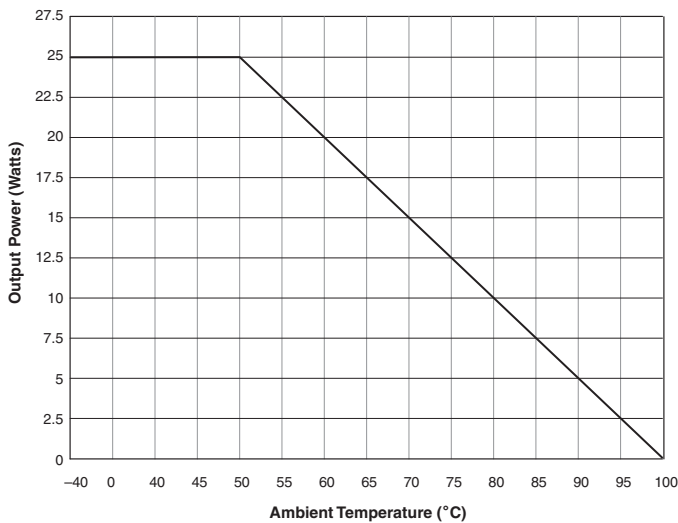

UNR-3.3/10-D5T/D5SM Output Power vs. Ambient Temperature, No Air Flow

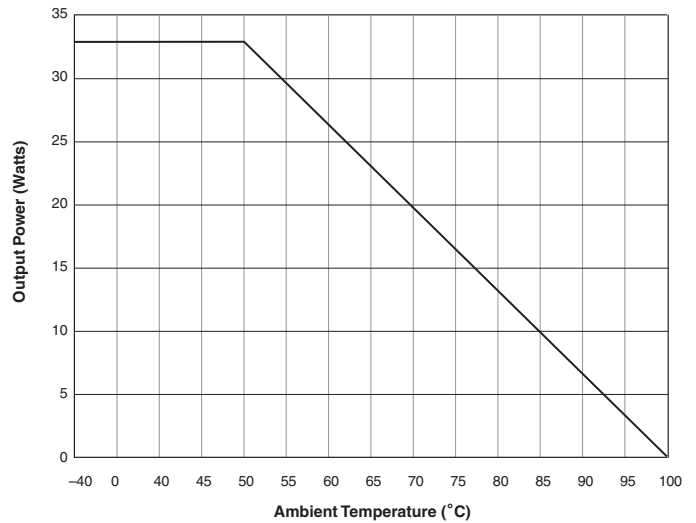

UNR-3.3/8-D5T/D5SM Output Power vs. Ambient Temperature, No Air Flow

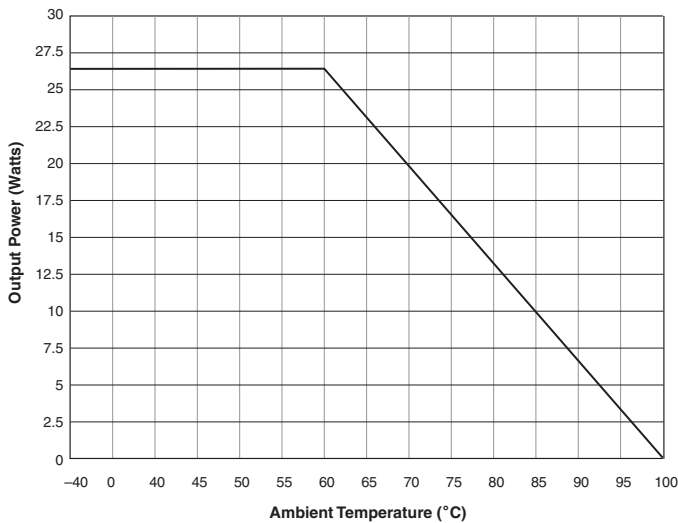

UNR-3.3/10-D12T/D12SM Output Power vs. Ambient Temperature, No Air Flow

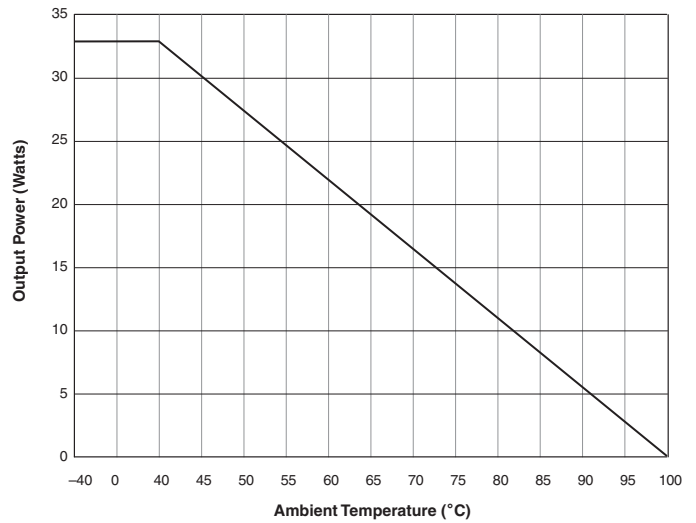

EFFICIENCY VS. LINE/LOAD

UNR-1.8/10-D5T/D5SM Efficiency vs. Line/Load

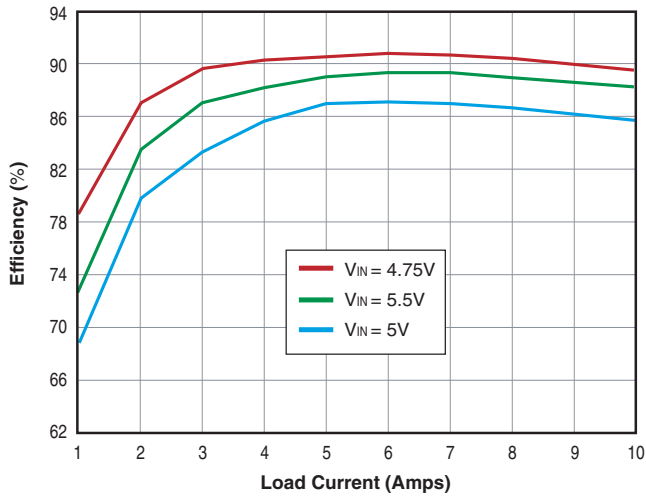

UNR-3.3/8-D5T/D5SM Efficiency vs. Line/Load

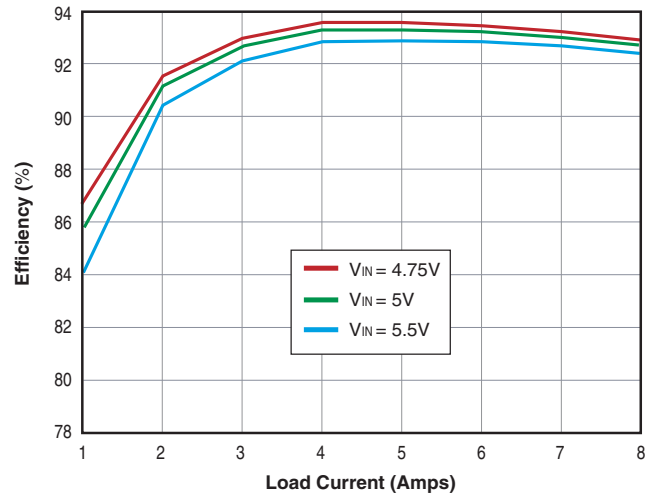

UNR-2.5/10-D5T/D5SM Efficiency vs. Line/Load

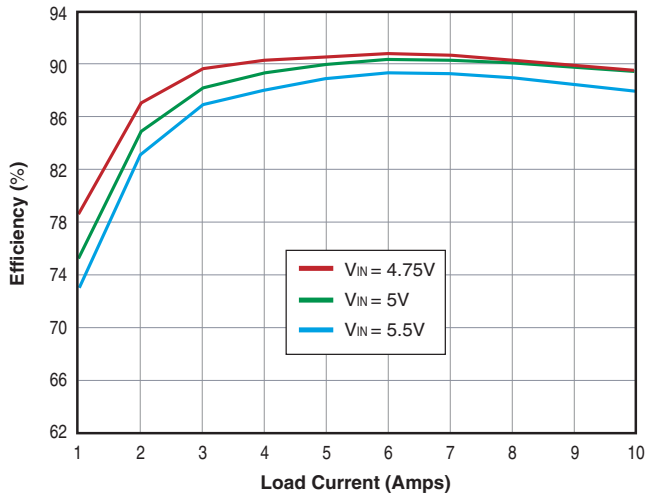

UNR-3.3/8-D12T/D12SM Efficiency vs. Line/Load

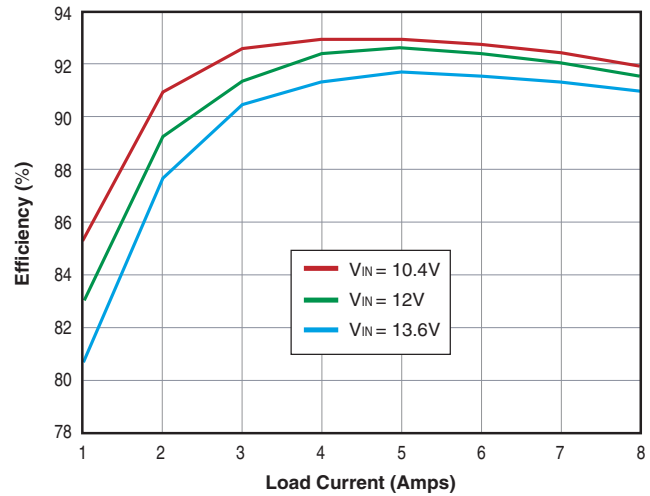

UNR-3.3/10-D5T/D5SM Efficiency vs. Line/Load

