

Transformers for Inverter TR Series

Coils, Transformers

TR9-B-S

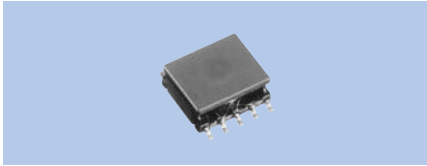

Specifications
 (1) –
 (2) 10~300kHz
 (3) 1W

Features
 SMD
 800pcs./Reel

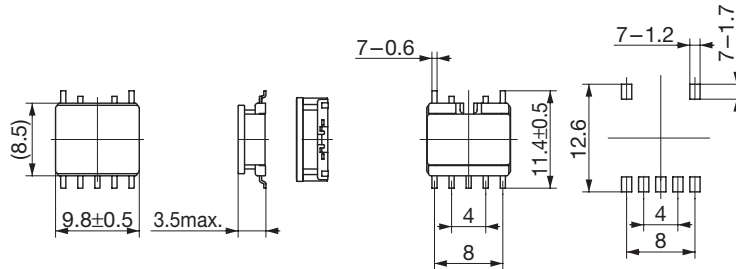

TR11-D-S

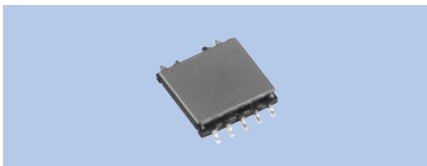

Specifications
 (1) –
 (2) 10~300kHz
 (3) 1W

Features
 SMD
 800pcs./Reel

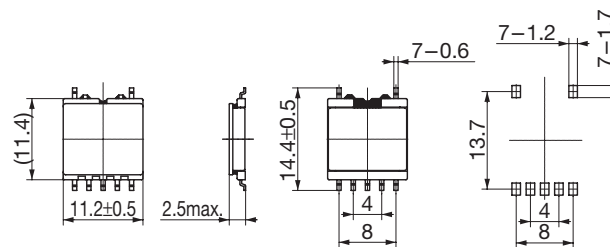

TR11-C-S

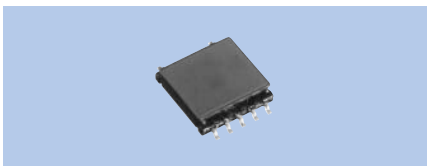

Specifications
 (1) –
 (2) 10~300kHz
 (3) 1.3W

Features
 SMD
 800pcs./Reel

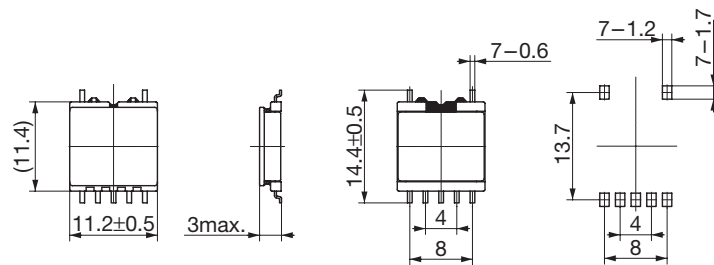

TR14-C-S

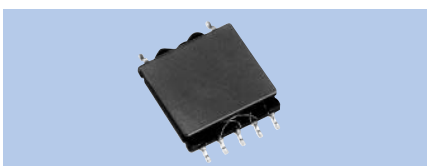

Specifications
 (1) –
 (2) 10~300kHz
 (3) 2W

Features
 SMD
 500pcs./Reel

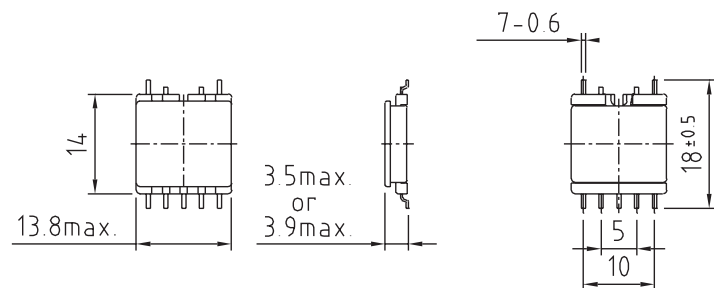

(1) Inductance
 (2) Operational frequency
 (3) Power capacity

TR21-A-S

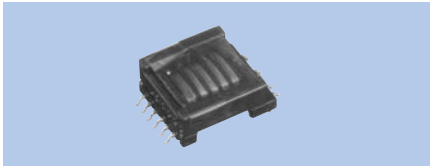

Specifications
 (1) -
 (2) 10~300kHz
 (3) 8W

Features
 SMD

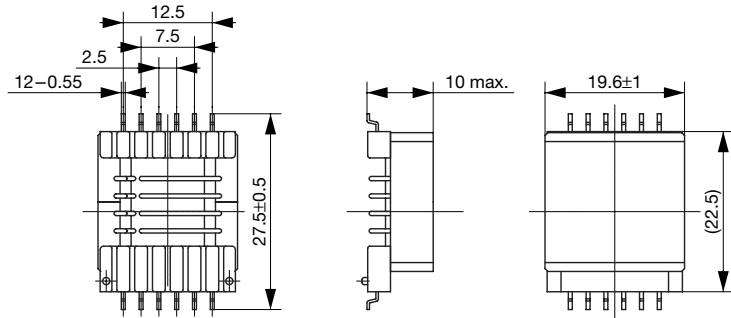

TR25-A-S

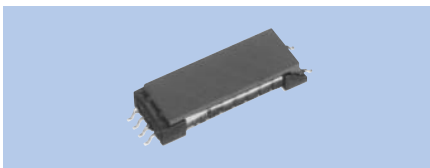

Specifications
 (1) -
 (2) 10~300kHz
 (3) 4W

Features
 SMD

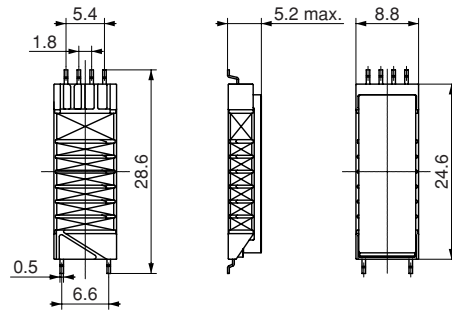

TR26-A-S

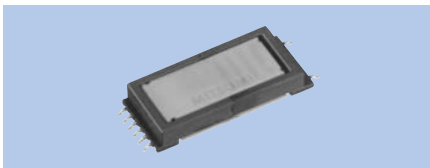

Specifications
 (1) -
 (2) 10~300kHz
 (3) 3W

Features
 SMD

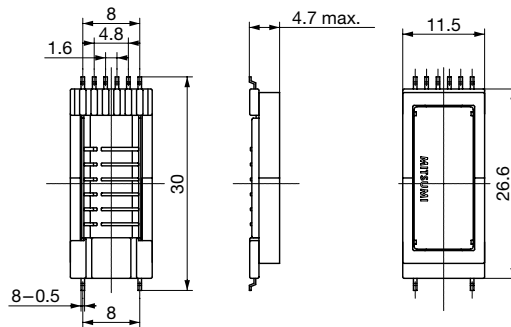

TR29-A-S

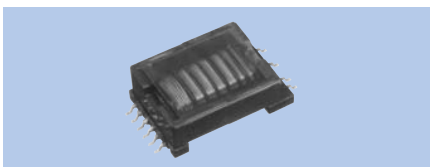

Specifications
 (1) -
 (2) 10~300kHz
 (3) 12W

Features
 SMD

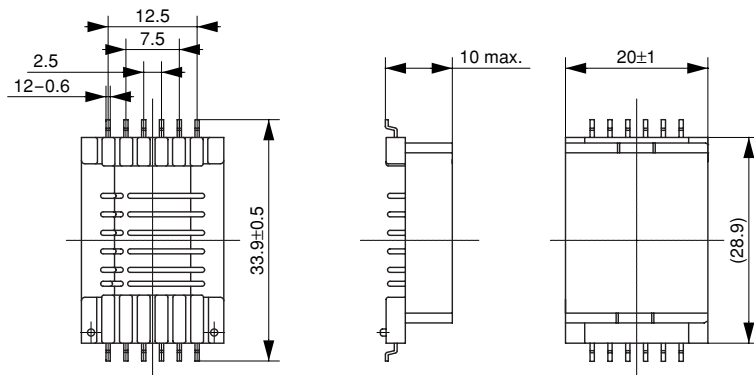

(1) Inductance
 (2) Operational frequency
 (3) Power capacity