

Transformers for DC-DC Converter C5-S, C6-R1, C8-R, TR Series

C5-S

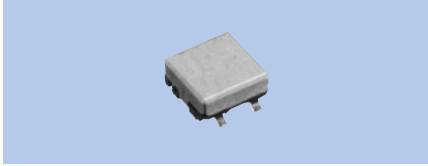

Specifications
(1) 1~180μH
(2) 10~300kHz
(3) -

Features
SMD
1000pcs./Reel

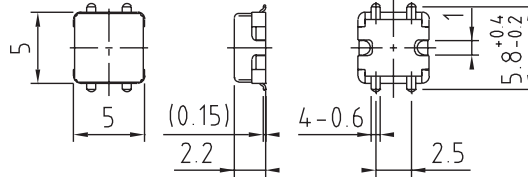

C5-S2



Specifications
(1) 1~180μH
(2) 10~300kHz
(3) -

Features
SMD
1000pcs./Reel

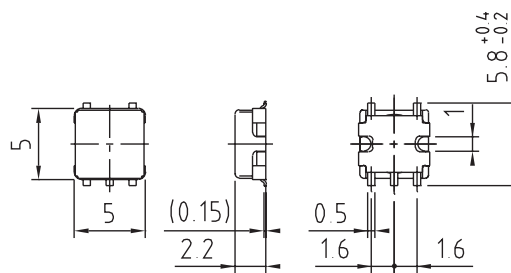

C6-R1-3L

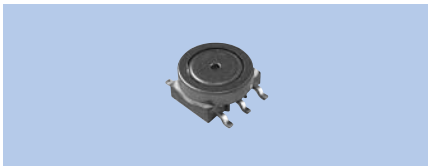

Specifications
(1) -
(2) 10~500kHz
(3) 0.7W

Features
SMD
1500pcs./Reel

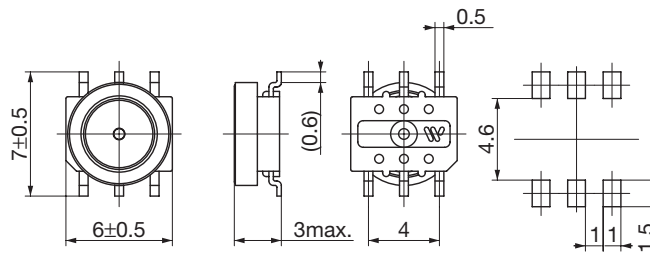

C6-R1-4L



Specifications
(1) -
(2) 10~500kHz
(3) 0.9W

Features
SMD
1500pcs./Reel

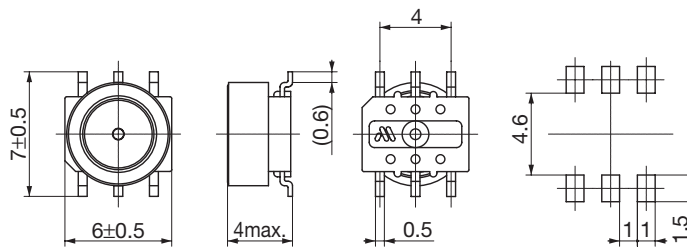

(1) Inductance
(2) Operational frequency
(3) Power capacity

C8-R1-4L



Specifications

- (1) -
- (2) 10~500kHz
- (3) 1.2W

Features

- SMD
- 1000pcs./Reel

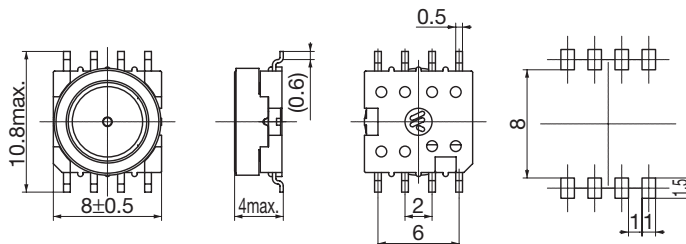

C8-R1-5L



Specifications

- (1) -
- (2) 10~500kHz
- (3) 1.5W

Features

- SMD
- 1000pcs./Reel

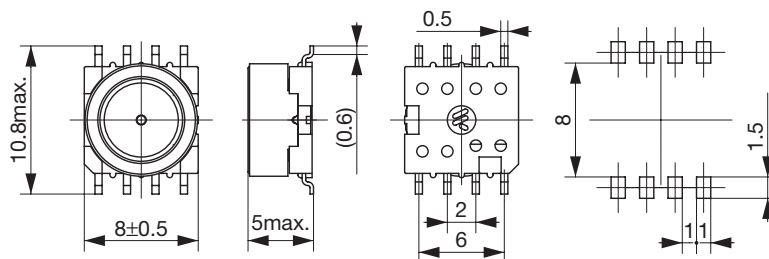

C8-R1-6L



Specifications

- (1) -
- (2) 10~500kHz
- (3) 1.8W

Features

- SMD
- 1000pcs./Reel

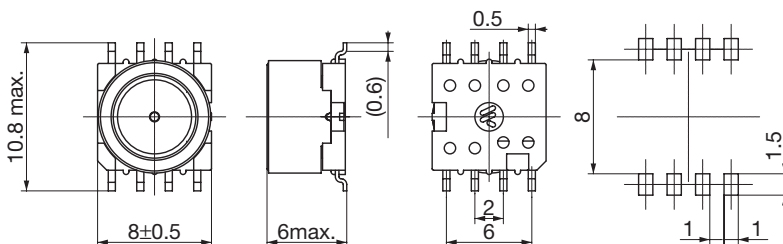

C8-R4L

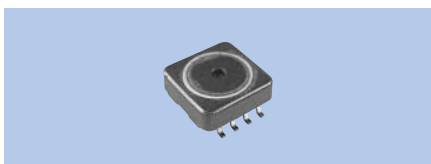

Specifications

- (1) -
- (2) 10~500kHz
- (3) 0.8W

Features

- SMD
- 1000pcs./Reel

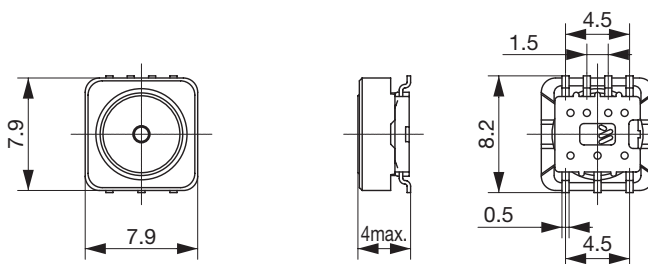

C8-R5L

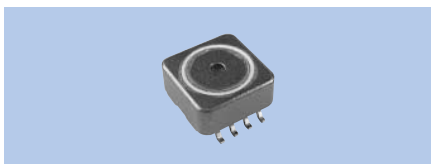

Specifications

- (1) -
- (2) 10~500kHz
- (3) 1.0W

Features

- SMD
- 1000pcs./Reel

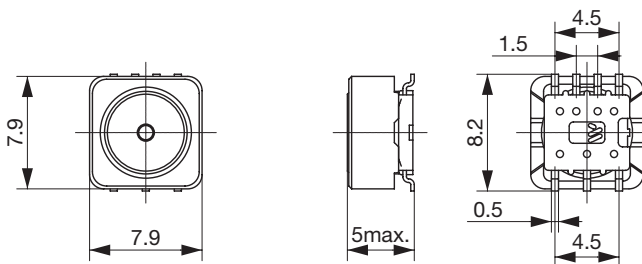

(1) Inductance
 (2) Operational frequency
 (3) Power capacity

C8-R6L

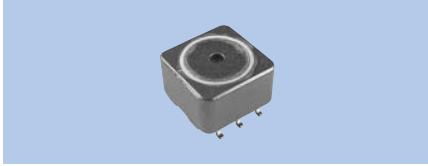

Specifications
 (1) –
 (2) 10~500kHz
 (3) 1.2W

Features
 SMD
 1500pcs./Reel

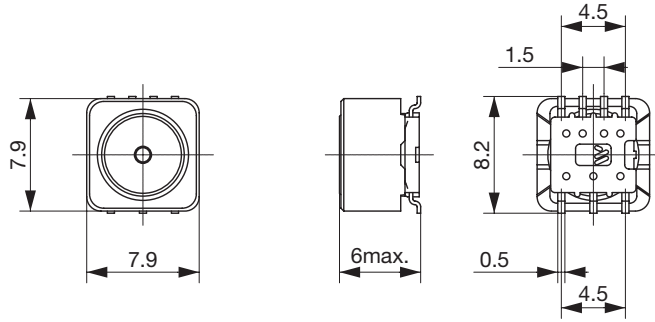

TR11-A1-S

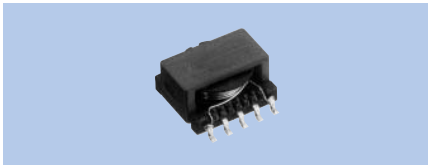

Specifications
 (1) –
 (2) 10~300kHz
 (3) 1.5W

Features
 SMD
 500pcs./Reel

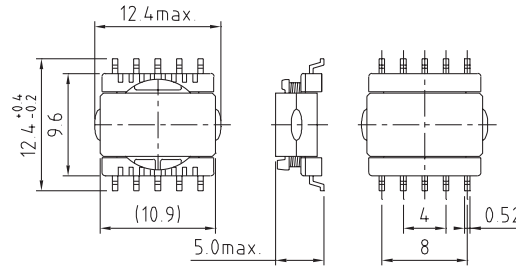

TR11-A-S

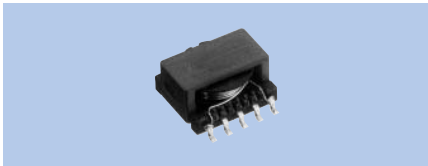

Specifications
 (1) –
 (2) 10~300kHz
 (3) 2W

Features
 SMD
 500pcs./Reel

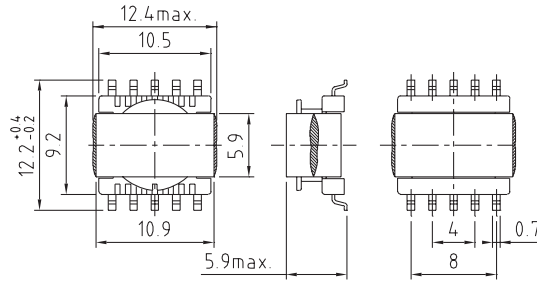

TR14-A-S

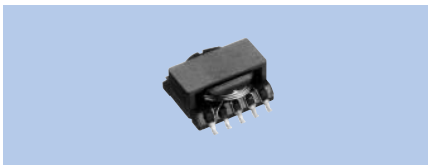

Specifications
 (1) –
 (2) 10~300kHz
 (3) 3.0W

Features
 SMD

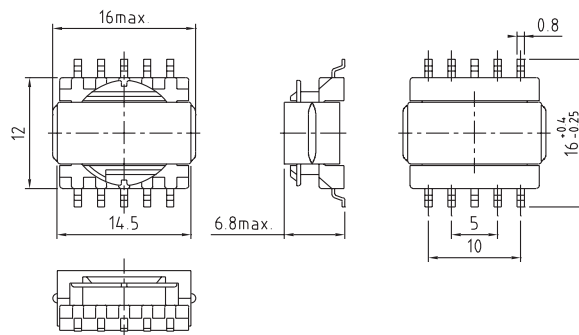

(1) Inductance
 (2) Operational frequency
 (3) Power capacity