

SPECIFICATIONS FOR NICHIA CHIP TYPE WHITE LED

MODEL : NSSW204T

NICHIA CORPORATION

1. SPECIFICATIONS

(1) Absolute Maximum Ratings (Ta=25°C)

Item	Symbol	Absolute Maximum Rating	Unit
Forward Current	I _F	25	mA
Pulse Forward Current	I _{FP}	80	mA
Reverse Voltage	V _R	5	V
Power Dissipation	P _D	88	mW
Operating Temperature	T _{opr}	-30 ~ + 85	°C
Storage Temperature	T _{stg}	-40 ~ +100	°C
Soldering Temperature	T _{sld}	Reflow Soldering : 260°C for 10sec. Hand Soldering : 350°C for 3sec.	

I_{FP} Conditions : Pulse Width ≤ 10msec. and Duty ≤ 1/10

(2) Initial Electrical/Optical Characteristics (Ta=25°C)

Item	Symbol	Condition	Typ.	Max.	Unit	
Forward Voltage	V _F	I _F =20[mA]	(3.2)	3.5	V	
Reverse Current	I _R	V _R = 5[V]	-	50	μA	
Luminous Flux	φ _v	I _F =20[mA]	(5.4)	-	lm	
Luminous Intensity	I _v	I _F =20[mA]	(1.95)	-	cd	
Chromaticity Coordinate*	x	-	I _F =20[mA]	0.300	-	-
	y	-	I _F =20[mA]	0.295	-	-

* Please refer to CIE 1931 chromaticity diagram.

(3) Ranking (Ta=25°C)

Item	Symbol	Condition	Min.	Max.	Unit	
Luminous Flux	Rank W575	φ _v	I _F =20[mA]	5.75	6.00	lm
	Rank W550	φ _v	I _F =20[mA]	5.50	5.75	lm
	Rank W525	φ _v	I _F =20[mA]	5.25	5.50	lm
	Rank W500	φ _v	I _F =20[mA]	5.00	5.25	lm
	Rank W475	φ _v	I _F =20[mA]	4.75	5.00	lm
	Rank W450	φ _v	I _F =20[mA]	4.50	4.75	lm

* Luminous Flux Measurement allowance is ± 7%.

Color Ranks

Rank Sa52				
x	0.280	0.272	0.282	0.288
y	0.248	0.258	0.272	0.262

Rank Sa57			
x	0.2720	0.2793	0.2820
y	0.2580	0.2755	0.2720

(I_F=20mA, Ta=25°C)

Rank Sa56				
x	0.283	0.280	0.288	0.291
y	0.244	0.248	0.262	0.258

Rank Sa62				
x	0.288	0.282	0.291	0.296
y	0.262	0.272	0.287	0.276

	Rank Sa66			
x	0.291	0.288	0.296	0.298
y	0.258	0.262	0.276	0.271

	Rank Sa67			
x	0.2820	0.2793	0.2887	0.2910
y	0.2720	0.2755	0.2916	0.2870

	Rank Sbj2			
x	0.296	0.291	0.299	0.304
y	0.276	0.287	0.301	0.290

	Rank Sbj6			
x	0.2980	0.2960	0.3040	0.3062
y	0.2710	0.2760	0.2900	0.2853

	Rank Sbj7			
x	0.2910	0.2887	0.2968	0.2990
y	0.2870	0.2916	0.3058	0.3010

	Rank Sbk2			
x	0.304	0.299	0.307	0.312
y	0.290	0.301	0.315	0.304

	Rank Sbk6			
x	0.3062	0.3040	0.3120	0.3142
y	0.2853	0.2900	0.3040	0.2993

	Rank Sbk7			
x	0.2990	0.2968	0.3048	0.3070
y	0.3010	0.3058	0.3198	0.3150

	Rank Sbm2			
x	0.312	0.307	0.315	0.320
y	0.304	0.315	0.329	0.318

	Rank Sbm6			
x	0.3142	0.3120	0.3200	0.3222
y	0.2993	0.3040	0.3180	0.3133

	Rank Sbm7			
x	0.3070	0.3048	0.3128	0.3150
y	0.3150	0.3198	0.3338	0.3290

* Color Coordinates Measurement allowance is ± 0.005 .

* Basically, a shipment shall consist of the LEDs of a combination of the above ranks.

The percentage of each rank in the shipment shall be determined by Nichia.

2. INITIAL OPTICAL/ELECTRICAL CHARACTERISTICS

Please refer to "CHARACTERISTICS" on the following pages.

3. OUTLINE DIMENSIONS AND MATERIALS

Please refer to "OUTLINE DIMENSIONS" on the following page.

4. PACKAGING

· The LEDs are packed in cardboard boxes after taping.

Please refer to "TAPING DIMENSIONS" and "PACKING" on the following pages.

The label on the minimum packing unit shows ; Part Number, Lot Number, Ranking, Quantity

- In order to protect the LEDs from mechanical shock, we pack them in cardboard boxes for transportation.
- The LEDs may be damaged if the boxes are dropped or receive a strong impact against them, so precautions must be taken to prevent any damage.
- The boxes are not water resistant and therefore must be kept away from water and moisture.
- When the LEDs are transported, we recommend that you use the same packing method as Nichia.

5.LOT NUMBER

The first six digits number shows **lot number**.

The lot number is composed of the following characters;

○□×××× - ◇◇◇

○ - Year (8 for 2008, 9 for 2009)

□ - Month (1 for Jan., 9 for Sep., A for Oct., B for Nov.)

×××× - Nichia's Product Number

◇◇◇ - Ranking by Color Coordinates, Ranking by Luminous Flux

6.RELIABILITY

(1) TEST ITEMS AND RESULTS

Test Item	Standard Test Method	Test Conditions	Note	Number of Damaged
Resistance to Soldering Heat (Reflow Soldering)	JEITA ED-4701 300 301	Tsld=260°C, 10sec. (Pre treatment 30°C,70%,168hrs.)	2 times	0/50
Solderability (Reflow Soldering)	JEITA ED-4701 303 303A	Tsld=245 ± 5°C, 5sec. using flux Lead-free Solder (Sn-3.0Ag-0.5Cu)	1 time over 95%	0/50
Temperature Cycle	JEITA ED-4701 100 105	-40°C ~ 25°C ~ 100°C ~ 25°C 30min. 5min. 30min. 5min.	100 cycles	0/50
Moisture Resistance Cyclic	JEITA ED-4701 200 203	25°C ~ 65°C ~ -10°C 90%RH 24hrs./1cycle	10 cycles	0/50
High Temperature Storage	JEITA ED-4701 200 201	Ta=100°C	1000 hrs.	0/50
Temperature Humidity Storage	JEITA ED-4701 100 103	Ta=60°C, RH=90%	1000 hrs.	0/50
Low Temperature Storage	JEITA ED-4701 200 202	Ta=-40°C	1000 hrs.	0/50
Steady State Operating Life Condition 1		Ta=25°C, IF=20mA	1000 hrs.	0/50
Steady State Operating Life Condition 2		Ta=25°C, IF=25mA	500 hrs.	0/50
Steady State Operating Life of High Temperature		Ta=85°C, IF=5mA	1000 hrs.	0/50
Steady State Operating Life of High Humidity Heat		60°C, RH=90%, IF=15mA	500 hrs.	0/50
Steady State Operating Life of Low Temperature		Ta=-30°C, IF=20mA	1000 hrs.	0/50
Vibration	JEITA ED-4701 400 403	100 ~ 2000 ~ 100Hz Sweep 4min. 200m/s ² 3directions, 4cycles	48min.	0/50
Substrate Bending	JEITA ED-4702	3mm, 5 ± 1 sec.	1 time	0/50

(2) CRITERIA FOR JUDGING DAMAGE

Item	Symbol	Test Conditions	Criteria for Judgement	
			Min.	Max.
Forward Voltage	V _F	I _F =20mA	-	U.S.L.*) × 1.1
Reverse Current	I _R	V _R =5V	-	U.S.L.*) × 2.0
Luminous Flux	φ _v	I _F =20mA	L.S.L.***) × 0.7	-

*) U.S.L. : Upper Standard Level

**) L.S.L. : Lower Standard Level

7.CAUTIONS

The LEDs are devices which are materialized by combining Blue LEDs and special phosphors. Consequently, the color of the LEDs is changed a little by an operating current. Care should be taken after due consideration when using LEDs.

(1) Moisture Proof Package

- When moisture is absorbed into the SMT package it may vaporize and expand during soldering. There is a possibility that this can cause exfoliation of the contacts and damage to the optical characteristics of the LEDs. For this reason, the moisture proof package is used to keep moisture to a minimum in the package.
- The moisture proof package is made of an aluminum moisture proof bag. A package of a moisture absorbent material (silica gel) is inserted into the aluminum moisture proof bag. The silica gel changes its color from blue to red as it absorbs moisture.

(2) Storage

· Storage Conditions

Before opening the package :

The LEDs should be kept at 30°C or less and 90%RH or less. The LEDs should be used within a year. When storing the LEDs, moisture proof packaging with absorbent material (silica gel) is recommended.

After opening the package :

The LEDs should be kept at 30°C or less and 70%RH or less. The LEDs should be soldered within 168 hours (7days) after opening the package. If unused LEDs remain, they should be stored in moisture proof packages, such as sealed containers with packages of moisture absorbent material (silica gel). It is also recommended to return the LEDs to the original moisture proof bag and to reseal the moisture proof bag again.

- If the moisture absorbent material (silica gel) has faded away or the LEDs have exceeded the storage time, baking treatment should be performed using the following conditions.
Baking treatment : more than 24 hours at $65 \pm 5^{\circ}\text{C}$
- This product has silver plated metal parts that are inside and/or outside the package body. The silver plating becomes tarnished when being exposed to an environment which contains corrosive gases. Any LED with tarnished leads may lead to poor solderability and deterioration of optical characteristics. Please do not expose the LEDs to corrosive atmosphere during storage.
- After assembly and during use, silver plating can be affected by the corrosive gases emitted by components and materials in close proximity of the LEDs within an end product, and the gases entering into the product from the external atmosphere. The above should be taken into consideration when designing.
- Please avoid rapid transitions in ambient temperature, especially in high humidity environments where condensation can occur.

(3) Recommended circuit

- In designing a circuit, the current through each LED must not exceed the absolute maximum rating specified for each LED. It is recommended to use Circuit B which regulates the current flowing through each LED. In the meanwhile, when driving LEDs with a constant voltage in Circuit A, the current through the LEDs may vary due to the variation in forward voltage (V_F) of the LEDs. In the worst case, some LED may be subjected to stresses in excess of the absolute maximum rating.

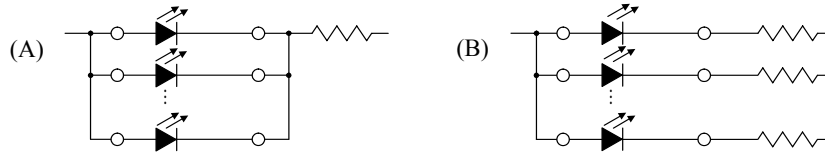

- This product should be operated in forward bias. A driving circuit must be designed so that the product is not subjected to either forward or reverse voltage while it is off. In particular, if a reverse voltage is continuously applied to the product, such operation can cause migration resulting in LED damage.

(4) Heat Generation

- Thermal design of the end product is of paramount importance. Please consider the heat generation of the LED when making the system design. The coefficient of temperature increase per input electric power is affected by the thermal resistance of the circuit board and density of LED placement on the board, as well as other components. It is necessary to avoid intense heat generation and operate within the maximum ratings given in this specification.
- The operating current should be decided after considering the ambient maximum temperature of LEDs.

(5) Soldering Conditions

- The LEDs can be soldered in place using the reflow soldering method. Nichia cannot make a guarantee on the LEDs after they have been assembled using the dip soldering method.
- NSSW204 is a lower profile design than our other products. Care must be taken in handling and assembly of this product in to avoid damage.
- Recommended soldering conditions

	Reflow Soldering		Hand Soldering	
	Lead Solder	Lead-free Solder	Temperature	Soldering time
Pre-heat	120 ~ 150°C	180 ~ 200°C	350°C Max. 3 sec. Max. (one time only)	
Pre-heat time	120 sec. Max.	120 sec. Max.		
Peak temperature	240°C Max.	260°C Max.		
Soldering time	10 sec. Max.	10 sec. Max.		
Condition	refer to Temperature - profile ①.	refer to Temperature - profile ②. (N ₂ reflow is recommended.)		

* Although the recommended soldering conditions are specified in the above table, reflow or hand soldering at the lowest possible temperature is desirable for the LEDs.

* A rapid-rate process is not recommended for cooling the LEDs down from the peak temperature.

[Temperature-profile (Surface of circuit board)]

Use the conditions shown to the under figure.

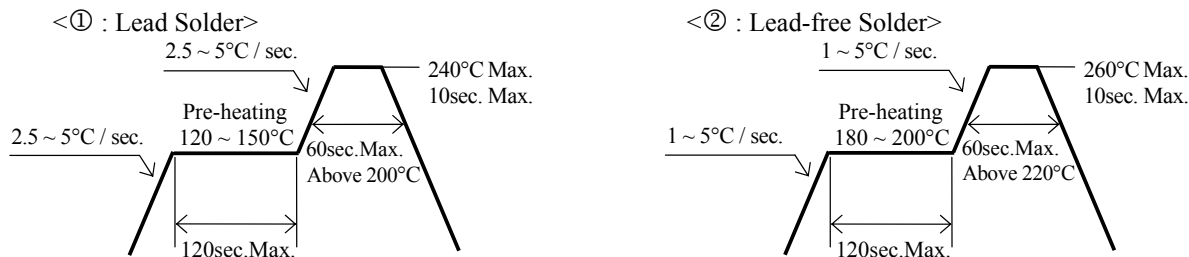

[Recommended soldering pad design]

Use the following conditions shown in the figure.

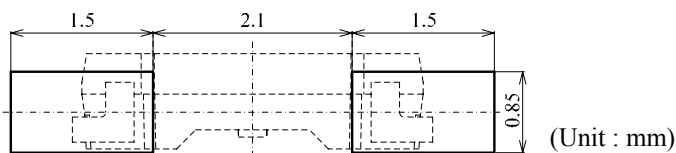

- Occasionally there is a brightness decrease caused by the influence of heat or ambient atmosphere during air reflow. It is recommended that the customer use the nitrogen reflow method.
- Repairing should not be done after the LEDs have been soldered. When repairing is unavoidable, a double-head soldering iron should be used. It should be confirmed beforehand whether the characteristics of the LEDs will or will not be damaged by repairing.
- Reflow soldering should not be done more than two times.
- When soldering, do not put stress on the LEDs during heating.
- After soldering, do not warp the circuit board.

(6) Cleaning

- It is recommended that isopropyl alcohol be used as a solvent for cleaning the LEDs. When using other solvents, it should be confirmed beforehand whether the solvents will dissolve the package and the resin or not. Freon solvents should not be used to clean the LEDs because of worldwide regulations.
- Do not clean the LEDs by the ultrasonic. When it is absolutely necessary, the influence of ultrasonic cleaning on the LEDs depends on factors such as ultrasonic power and the assembled condition. Before cleaning, a pre-test should be done to confirm whether any damage to the LEDs will occur.

(7) Static Electricity

- Static electricity or surge voltage damages the LEDs.
It is recommended that a wrist band or an anti-electrostatic glove be used when handling the LEDs.
- All devices, equipment and machinery must be properly grounded. It is recommended that precautions be taken against surge voltage to the equipment that mounts the LEDs.
- When inspecting the final products in which LEDs were assembled, it is recommended to check whether the assembled LEDs are damaged by static electricity or not. It is easy to find static-damaged LEDs by a light-on test or a VF test at a lower current (below 1mA is recommended).
- Damaged LEDs will show some unusual characteristics such as the leak current remarkably increases, the forward voltage becomes lower, or the LEDs do not light at the low current.

Criteria : (VF > 2.0V at IF=0.5mA)

(8) Safety Guideline for Human Eyes

- The International Electrical Commission (IEC) published in 2006 IEC 62471:2006 *Photobiological safety of lamps and lamp systems* which includes LEDs within its scope. Meanwhile LEDs were removed from the scope of the IEC 60825-1:2007 laser safety standard, the 2001 edition of which included LED sources within its scope. However, keep in mind that some countries and regions have adopted standards based on the IEC laser safety standard IEC 60825-1:2001 which includes LEDs within its scope.

Following IEC 62471:2006, most of Nichia LEDs can be classified as belonging to either Exempt Group or Risk Group 1. Optical characteristics of a LED such as output power, spectrum and light distribution are factors that affect the risk group determination of the LED. Especially a high-power LED, that emits light containing blue wavelengths, may be in Risk Group 2.

Great care should be taken when viewing directly the LED driven at high current or the LED with optical instruments, which may greatly increase the hazard to your eyes.

(9) Others

- NSSW204 complies with RoHS Directive.
- Care must be taken to ensure that the reverse voltage will not exceed the absolute maximum rating when using the LEDs with matrix drive.
- Flashing lights have been known to cause discomfort in people; you can prevent this by taking precautions during use. Also, people should be cautious when using equipment that has had LEDs incorporated into it.
- The LEDs described in this brochure are intended to be used for ordinary electronic equipment (such as office equipment, communications equipment, measurement instruments and household appliances). Consult Nichia's sales staff in advance for information on the applications in which exceptional quality and reliability are required, particularly when the failure or malfunction of the LEDs may directly jeopardize life or health (such as for airplanes, aerospace, submersible repeaters, nuclear reactor control systems, automobiles, traffic control equipment, life support systems and safety devices).
- The customer shall not reverse engineer by disassembling or analysis of the LEDs without having prior written consent from Nichia. When defective LEDs are found, the customer shall inform Nichia directly before disassembling or analysis.
- The formal specifications must be exchanged and signed by both parties before large volume purchase begins.
- The appearance and specifications of the product may be modified for improvement without notice.

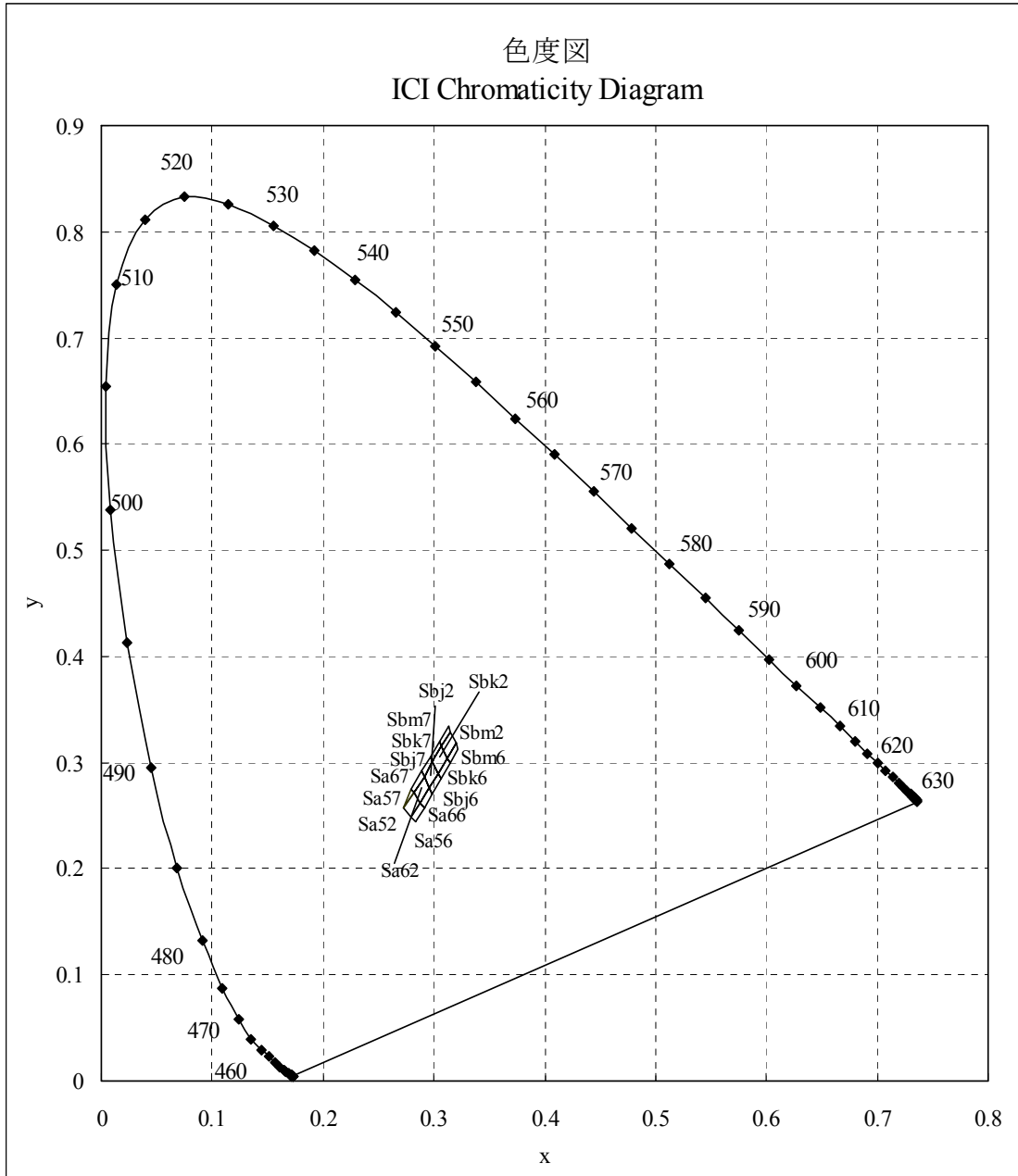

* Color Coordinates Measurement allowance is ± 0.005 .

■ 順電圧-順電流特性
Forward Voltage vs.
Forward Current

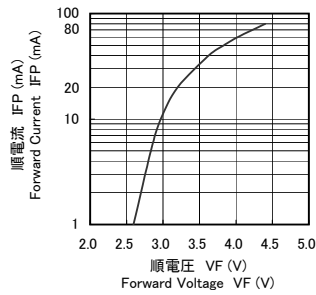

■ 順電流-相対光束特性
Forward Current vs.
Relative Luminous Flux

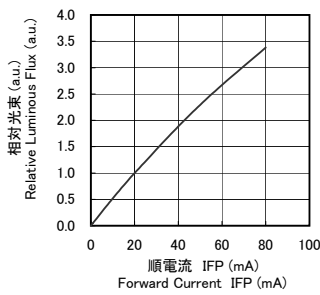

■ デューティー比-許容順電流特性
Duty Ratio vs.
Allowable Forward Current

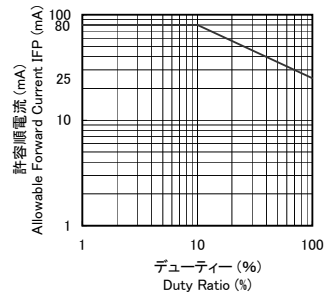

■ 周囲温度-順電圧特性
Ambient Temperature vs.
Forward Voltage

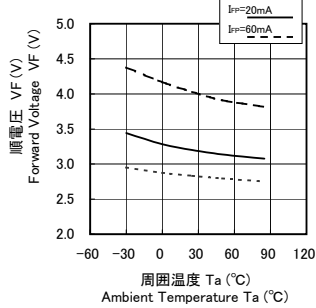

■ 周囲温度-相対光束特性
Ambient Temperature vs.
Relative Luminous Flux

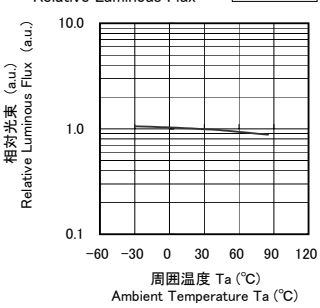

■ 周囲温度-許容順電流特性
Ambient Temperature vs.
Allowable Forward Current

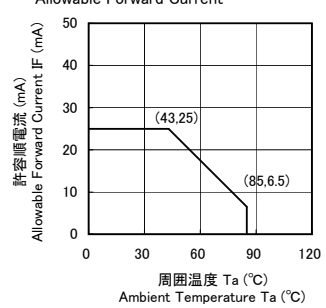

型名 Model	NSSW204	名称 Title	初期電気/光学特性 CHARACTERISTICS
日亜化学工業 (株) NICHIA CORPORATION		管理番号 No.	090526 832573

■ 順電流-色度特性
Forward Current vs.
Chromaticity Coordinate
Ta=25°C

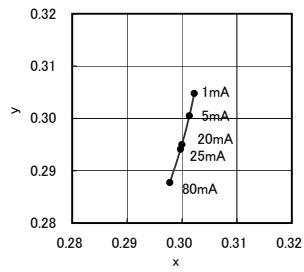

■ 発光スペクトル
Spectrum
Ta=25°C
If= 20mA

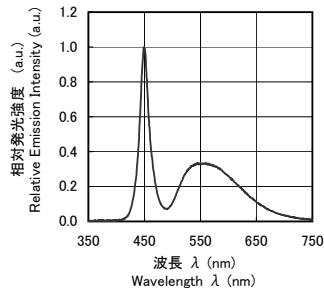

■ 周囲温度-色度特性
Ambient Temperature vs.
Chromaticity Coordinate
IfP= 20mA

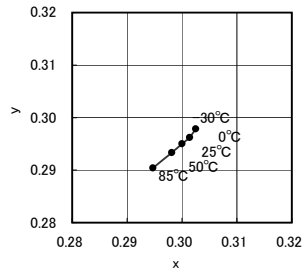

■ 指向特性
Directivity
Ta=25°C
IfP= 20mA

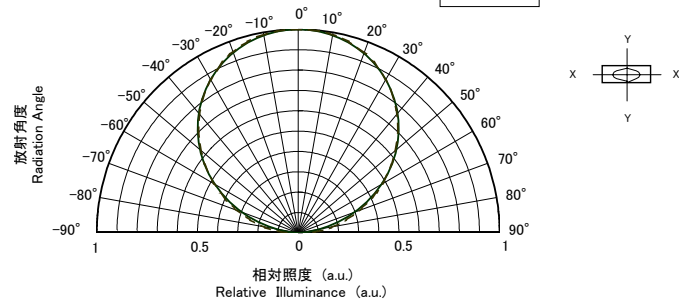

型名 Model	NSSW204	名称 Title	初期電気/光学特性 CHARACTERISTICS
日亜化学工業 (株) NICHIA CORPORATION		管理番号 No.	090526832582

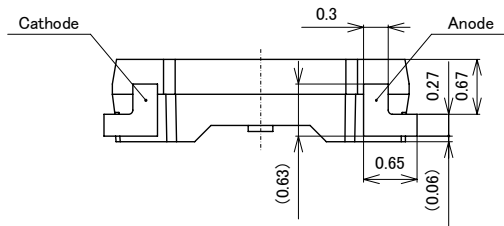
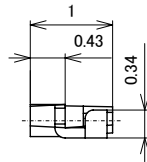
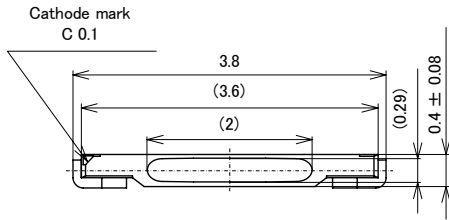
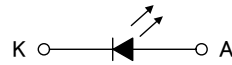
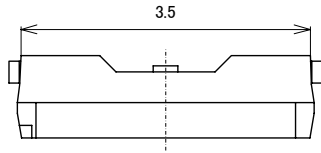

項目 Item	材質 Materials
パッケージ材質 Package	耐熱性ポリマー Heat-Resistant Polymer
封止樹脂 Encapsulating Resin	シリコン樹脂 (拡散剤 + 蛍光体入り) Silicone Resin (with Diffused + Phosphor)
電極 Electrodes	銅合金 + 銀メッキ Ag Plating Copper Alloy

(注) バリは寸法に含まないものとします。
(NOTE) The LED may have flash/flange which exceeds the tolerance of this print.

型名 Model NSSW204	名称 Title 外形寸法図 OUTLINE DIMENSIONS	単位 Unit mm
日亜化学工業 (株) NICHIA CORPORATION	管理番号 No. 081128832121	公差 Allow ±0.1

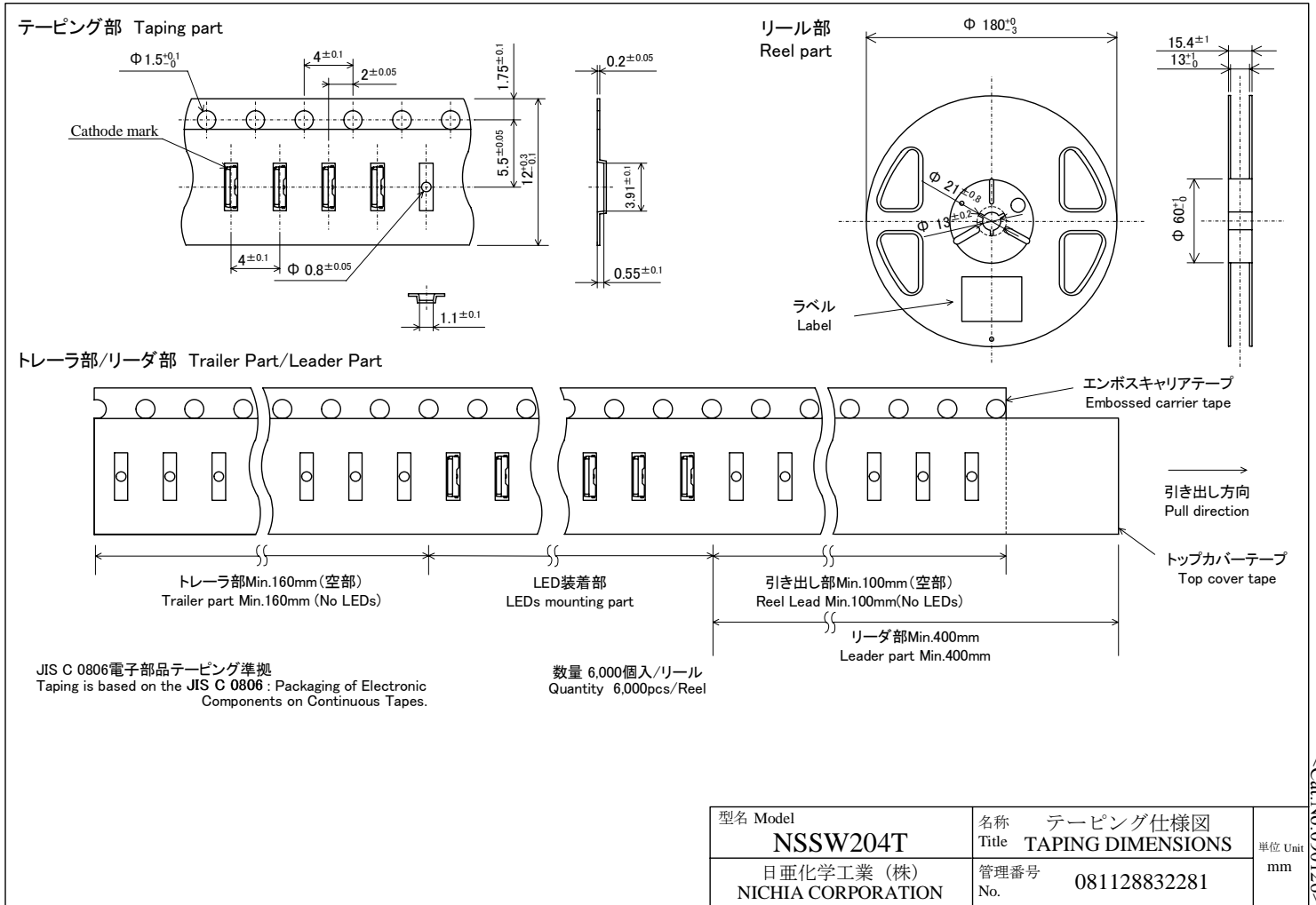

型名 Model NSSW204T	名称 テーピング仕様図 Title TAPING DIMENSIONS	単位 Unit mm
日亜化学工業(株) NICHIA CORPORATION	管理番号 No. 081128832281	

Nichia STS-DA1-0486A
<Cat.No.090126>

シリカゲルとともにリールをアルミ防湿袋に入れ、熱シールにより封をする。

The reel and moisture absorbent material are put in the moisture proof foil bag and then heat sealed.

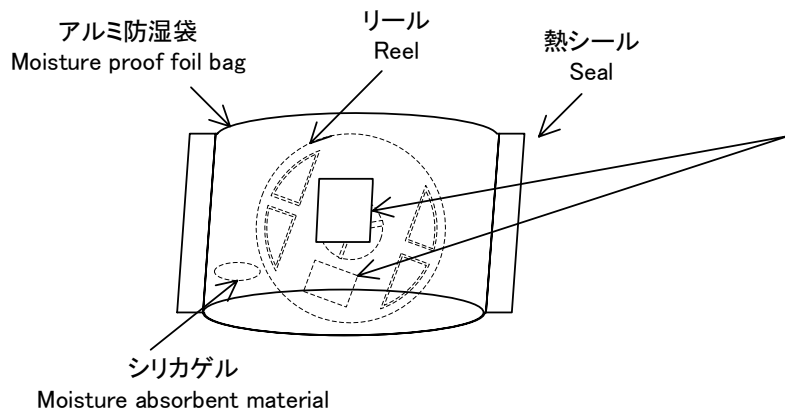

ラベル Label

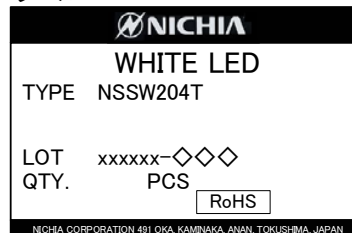

ダンボールで仕切りをする

The box is partitioned with the cardboard.

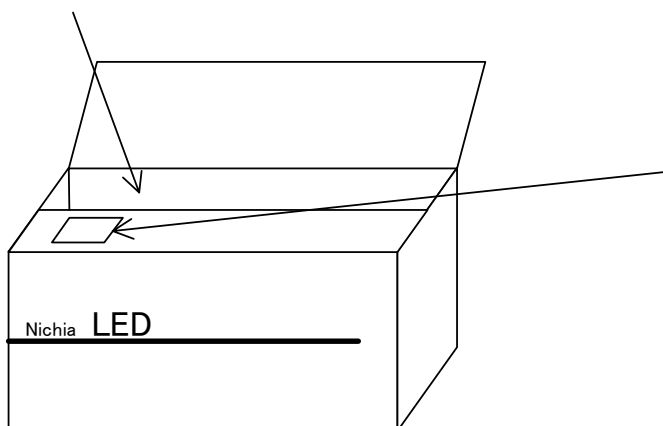

ラベル Label



基本梱包単位 Packing Unit

	リール数 Reel/ bag	チップ个数 Quantity/bag(pcs)
アルミ防湿袋 Moisture proof foil bag	1reel	6,000MAX.

梱包箱(段ボール) Cardbord box	箱の寸法 Dimensions(mm)	リール数 Reel/box	チップ个数 Quantity/box(pcs)
S	291 × 237 × 120 × 8t	5reel MAX.	30,000 MAX.
M	259 × 247 × 243 × 5t	10reel MAX.	60,000 MAX.
L	444 × 262 × 259 × 8t	20reel MAX.	120,000 MAX.

型名 Model NSSW204T	名称 Title 梱包仕様図 PACKING
日亜化学工業 (株) NICHIA CORPORATION	管理番号 No. 090202832292