

## LP3988

# Micropower, 150mA Ultra Low-Dropout CMOS Voltage Regulator With Power Good

### General Description

The LP3988 is a 150mA low dropout regulator designed specially to meet requirements of Portable battery-applications. The LP3988 is designed to work with a space saving, small 1 $\mu$ F ceramic capacitor. The LP3988 features an Error Flag output that indicates a faulty output condition.

The LP3988's performance is optimized for battery powered systems to deliver low noise, extremely low dropout voltage and low quiescent current. Regulator ground current increases only slightly in dropout, further prolonging the battery life.

Power supply rejection is better than 60 dB at low frequencies and starts to roll off at 10 kHz. High power supply rejection is maintained down to lower input voltage levels common to battery operated circuits.

The device is ideal for mobile phone and similar battery powered wireless applications. It provides up to 150 mA, from a 2.5V to 6V input, consuming less than 1  $\mu$ A in disable mode and has fast turn-on time less than 200 $\mu$ s.

The LP3988 is available 5 pin SOT-23 package and 5 bump thin micro SMD package. Performance is specified for  $-40^{\circ}$ C to  $+125^{\circ}$ C temperature range and is available in 1.85, 2.5, 2.6, 2.85, 3.0 and 3.3V output voltages.

### Key Specifications

- 2.5 to 6.0V input range
- 150mA guaranteed output

- 40dB PSRR at 10kHz
- $\leq 1$   $\mu$ A quiescent current when shut down
- Fast Turn-On time: 100  $\mu$ s (typ.)
- 80 mV typ dropout with 150mA load
- $-40$  to  $+125^{\circ}$ C junction temperature range for operation
- 1.85V, 2.5V, 2.6V, 2.85V, 3.0V, and 3.3V

### Features

- 5 bump thin micro SMD package
- SOT-23-5 package
- Power-good flag output
- Logic controlled enable
- Stable with ceramic and high quality tantalum capacitors
- Fast turn-on
- Thermal shutdown and short-circuit current limit

### Applications

- CDMA cellular handsets
- Wideband CDMA cellular handsets
- GSM cellular handsets
- Portable information appliances
- Tiny 3.3V  $\pm 5\%$  to 2.85V, 150mA converter

### Typical Application Circuit

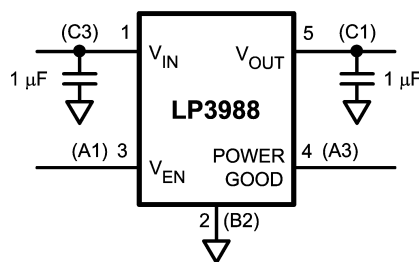

Note: Pin numbers in parentheses indicate micro SMD package pin out

20020502

## Block Diagram

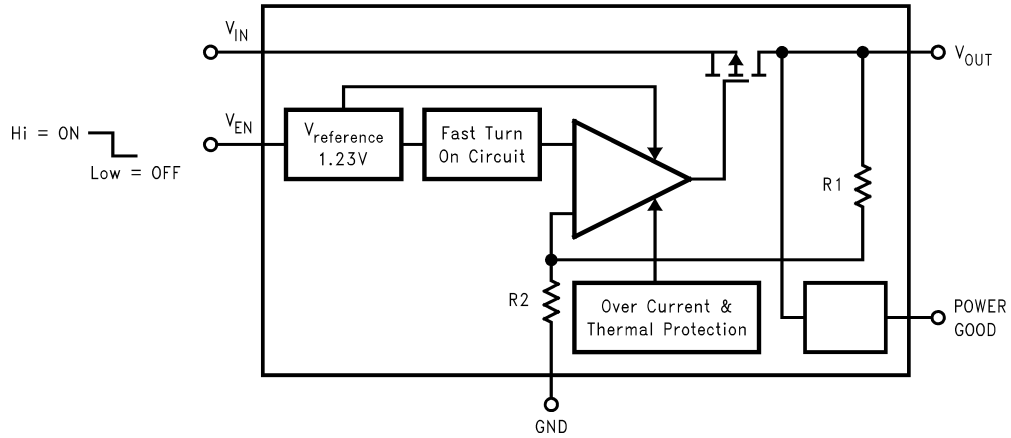

20020501

## Pin Descriptions

Name	micro SMD	SOT	Function
$V_{EN}$	A1	3	Enable Input Logic, Enable High
GND	B2	2	Common Ground
$V_{OUT}$	C1	5	Output Voltage of the LDO
$V_{IN}$	C3	1	Input Voltage of the LDO
Power Good	A3	4	Power Good Flag (output): open-drain output, connected to an external pull-up resistor. Active low indicates an output voltage out of tolerance condition.

## Connection Diagrams

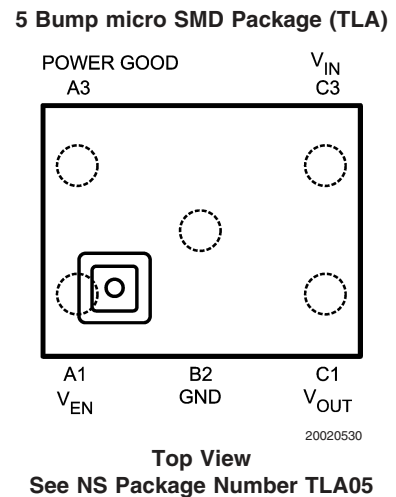
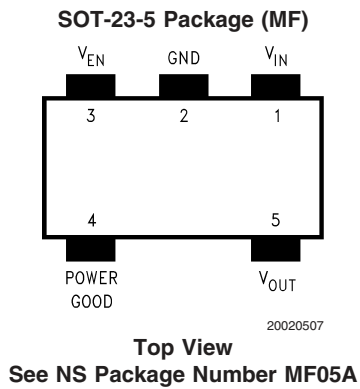

## Ordering Information

### SOT23-5 Package

Output Voltage (V)	Grade	LP3988 Supplied as 1000 Units, Tape and Reel	LP3988 Supplied as 3000 Units, Tape and Reel	Package Marking
2.5	STD	LP3988IMF-2.5	LP3988IMFX-2.5	LF5B
2.6	STD	LP3988IMF-2.6	LP3988IMFX-2.6	LDJB
2.85	STD	LP3988IMF-2.85	LP3988IMFX-2.85	LDLB
3.0	STD	LP3988IMF-3.0	LP3988IMFX-3.0	LFAB
3.3	STD	LP3988IMF-3.3	LP3988IMFX-3.3	LH5B

### 5 Bump Thin Micro SMD Package

Output Voltage (V)	Grade	LP3988 Supplied as 250 Units, Tape and Reel	LP3988 Supplied as 3000 Units, Tape and Reel
1.85	STD	LP3988ITL-1.85	LP3988ITLX-1.85
2.6	STD	LP3988ITL-2.6	LP3988ITLX-2.6
2.85	STD	LP3988ITL-2.85	LP3988ITLX-2.85

**Absolute Maximum Ratings** (Notes 1, 2)

If Military/Aerospace specified devices are required, please contact the National Semiconductor Sales Office/Distributors for availability and specifications.

$V_{IN}$	-0.3 to 6.5V
$V_{OUT}$ , $V_{EN}$ , PowerGood (applies only to micro SMD)	-0.3V to ( $V_{IN}+0.3V$ ), with 6V max
Junction Temperature	150°C
Storage Temperature	-65°C to +150°C
Lead Temp, Pad Temp.	235°C
Power Dissipation (Note 3)	
SOT23-5	364mW
micro SMD	355mW

## ESD Rating (Note 4)

Human Body Model	2kV
Machine Model	
SOT23-5 (Note 13)	150V
micro SMD	200V

**Operating Ratings** (Notes 1, 2)

$V_{IN}$ (Note 15)	2.5V to 6V
$V_{OUT}$ , $V_{EN}$	0 to $V_{IN}$
Junction Temperature	-40°C to +125°C
Junction-to-Ambient Thermal Resistance ( $\theta_{JA}$ )	
SOT23-5	220°C/W
micro SMD	255°C/W
Maximum Power Dissipation (Note 5)	
SOT23-5	250mW
micro SMD	244mW

**Electrical Characteristics**

Unless otherwise specified:  $V_{EN} = 1.8V$ ,  $V_{IN} = V_{OUT} + 0.5V$ ,  $C_{IN} = 1 \mu F$ ,  $I_{OUT} = 1mA$ ,  $C_{OUT} = 1 \mu F$ . Typical values and limits appearing in standard typeface are for  $T_J = 25^\circ C$ . Limits appearing in **boldface type** apply over the entire junction temperature range for operation, -40°C to +125°C. (Note 6) (Note 7)

Symbol	Parameter	Conditions	Typ	Limit		Units
				Min	Max	
$\Delta V_{OUT}$	Output Voltage Tolerance	-20°C ≤ $T_J$ ≤ 125°C, SOT23-5 -40°C ≤ $T_J$ ≤ 125°C, SOT23-5 -40°C ≤ $T_J$ ≤ 125°C, micro SMD		-2 -3 -3.5	2 3 3.5	% of $V_{OUT(nom)}$
	Line Regulation Error	$V_{IN} = V_{OUT(NOM)} + 0.5V$ to 6.0V		-0.15 -0.2	0.15 0.2	%/V
	Load Regulation Error (Note 8)	$I_{OUT} = 1 mA$ to 150 mA			0.005 0.007	%/mA
	PSRR	Power Supply Rejection Ratio	$V_{IN} = V_{OUT(nom)} + 1V$ , $f = 1 kHz$ , $I_{OUT} = 50 mA$ (Figure 3) $V_{IN} = V_{OUT(nom)} + 1V$ , $f = 10 kHz$ , $I_{OUT} = 50 mA$ (Figure 3)	65 45		
$I_Q$	Quiescent Current	$V_{EN} = 1.4V$ , $I_{OUT} = 0 mA$	85		120	μA
		$V_{EN} = 1.4V$ , $I_{OUT} = 0$ to 150 mA	140		200	
		$V_{EN} = 0.4V$	0.003		1.0	
	Dropout Voltage (Note 9)	$I_{OUT} = 1 mA$	1		5	mV
		$I_{OUT} = 150 mA$	80		115 150	
$I_{SC}$	Short Circuit Current Limit	(Note 10)	600			mA
$e_n$	Output Noise Voltage	BW = 10 Hz to 100 kHz, $C_{OUT} = 1 \mu F$	220			μVrms
$C_{OUT}$	Output Capacitor	Capacitance (Note 11)		1	20	μF
		ESR (Note 11)		5	500	mΩ
TSD	Thermal Shutdown Temperature		160			°C
	Thermal Shutdown Hysteresis		20			°C
<b>Enable Control Characteristics (Note 12)</b>						
$I_{EN}$	Maximum Input Current at EN	$V_{EN} = 0$ and $V_{IN} = 6.0V$			0.1	μA

## Electrical Characteristics (Continued)

Unless otherwise specified:  $V_{EN} = 1.8V$ ,  $V_{IN} = V_{OUT} + 0.5V$ ,  $C_{IN} = 1 \mu F$ ,  $I_{OUT} = 1mA$ ,  $C_{OUT} = 1 \mu F$ . Typical values and limits appearing in standard typeface are for  $T_J = 25^\circ C$ . Limits appearing in **boldface type** apply over the entire junction temperature range for operation,  $-40^\circ C$  to  $+125^\circ C$ . (Note 6) (Note 7)

Symbol	Parameter	Conditions	Typ	Limit		Units
				Min	Max	
$V_{IL}$	Logic Low Input threshold	$V_{IN} = 2.5V$ to $6.0V$			<b>0.5</b>	V
$V_{IH}$	Logic High Input threshold	$V_{IN} = 2.5V$ to $6.0V$		<b>1.2</b>		V
<b>Power Good</b>						
$V_{THL}$	Power Good Low threshold	% of $V_{OUT}$ (PG ON) <i>Figure 2</i>	93	90	95	%
$V_{THH}$	Power Good High Threshold	% of $V_{OUT}$ (PG OFF) <i>Figure 2</i> (Note 14)	95	92	98	%
$V_{OL}$	PG Output Logic Low Voltage	$I_{PULL-UP} = 100\mu A$ , fault condition	0.02		<b>0.1</b>	V
$I_{PGL}$	PG Output Leakage Current	PG Off, $V_{PG} = 6V$	0.02			$\mu A$
$T_{ON}$	Power Good Turn On time, (Note 9)	$V_{IN} = 4.2V$	10			$\mu s$
$T_{OFF}$	Power Good Turn Off time, (Note 9)	$V_{IN} = 4.2V$	10			$\mu s$

**Note 1:** Absolute Maximum Ratings are limits beyond which damage to the device may occur. Operating Ratings are conditions under which operation of the device is guaranteed. Operating Ratings do not imply guaranteed performance limits. For guaranteed performance limits and associated test conditions, see the Electrical Characteristics tables.

**Note 2:** All voltages are with respect to the potential at the GND pin.

**Note 3:** The Absolute Maximum power dissipation depends on the ambient temperature and can be calculated using the formula:

$$P_D = (T_J - T_A) / \theta_{JA}$$

where  $T_J$  is the junction temperature,  $T_A$  is the ambient temperature, and  $\theta_{JA}$  is the junction-to-ambient thermal resistance. The 364mW rating appearing under Absolute Maximum Ratings for the SOT23-5 package results from substituting the Absolute Maximum junction temperature,  $150^\circ C$ , for  $T_J$ ,  $70^\circ C$  for  $T_A$ , and  $220^\circ C/W$  for  $\theta_{JA}$ . More power can be dissipated safely at ambient temperatures below  $70^\circ C$ . Less power can be dissipated safely at ambient temperatures above  $70^\circ C$ . The Absolute Maximum power dissipation can be increased by 4.5mW for each degree below  $70^\circ C$ , and it must be derated by 4.5mW for each degree above  $70^\circ C$ . Same principle applies to the micro SMD package.

**Note 4:** The human body model is 100pF discharged through 1.5k $\Omega$  resistor into each pin. The machine model is a 200 pF capacitor discharged directly into each pin.

**Note 5:** Like the Absolute Maximum power dissipation, the maximum power dissipation for operation depends on the ambient temperature. The 250mW rating appearing under Operating Ratings for the SOT23-5 package results from substituting the maximum junction temperature for operation,  $125^\circ C$ , for  $T_J$ ,  $70^\circ C$  for  $T_A$ , and  $220^\circ C/W$  for  $\theta_{JA}$  into (Note 3) above. More power can be dissipated at ambient temperatures below  $70^\circ C$ . Less power can be dissipated at ambient temperatures above  $70^\circ C$ . The maximum power dissipation for operation can be increased by 4.5mW for each degree below  $70^\circ C$ , and it must be derated by 4.5mW for each degree above  $70^\circ C$ . Same principle applies to the micro SMD package.

**Note 6:** All limits are guaranteed. All electrical characteristics having room-temperature limits are tested during production with  $T_J = 25^\circ C$  or correlated using Statistical Quality Control (SQC) methods. All hot and cold limits are guaranteed by correlating the electrical characteristics to process and temperature variations and applying statistical process control.

**Note 7:** The target output voltage, which is labeled  $V_{OUT(nom)}$ , is the desired voltage option.

**Note 8:** An increase in the load current results in a slight decrease in the output voltage and vice versa.

**Note 9:** Dropout voltage is the input-to-output voltage difference at which the output voltage is 100mV below its nominal value.

**Note 10:** Short circuit current is measured on input supply line after pulling down  $V_{OUT}$  to 95%  $V_{OUT(nom)}$ .

**Note 11:** Guaranteed by design. The capacitor tolerance should be  $\pm 30\%$  or better over the full temperature range. The full range of operating conditions such as temperature, DC bias and even capacitor case size for the capacitor in the application should be considered during device selection to ensure this minimum capacitance specification is met. X7R capacitor types are recommended to meet the full device temperature range.

**Note 12:** Turn-on time is time measured between the enable input just exceeding  $V_{IH}$  and the output voltage just reaching 95% of its nominal value.

**Note 13:** 100V machine model for Power-good flag, pin 4.

**Note 14:** The low and high thresholds are generated together. Typically a 2.6% difference is seen between these thresholds.

**Note 15:** The minimum  $V_{IN}$  is dependant on the device output option.

For  $V_{out(NOM)} < 2.5V$ ,  $V_{IN(MIN)}$  will equal 2.5V. For  $V_{out(NOM)} \geq 2.5V$ ,  $V_{IN(MIN)}$  will equal  $V_{out(NOM)} + 200mV$ .

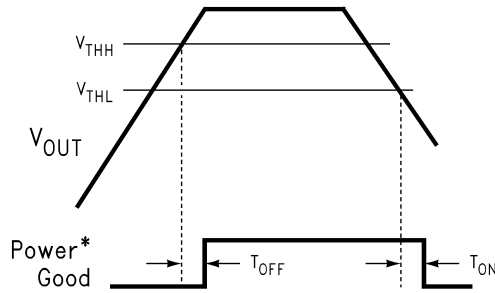

\*Power good pin pulled up to  $V_{OUT}$  through an external pull-up resistor.  
20020522

**FIGURE 1. Power Good Flag Timing**

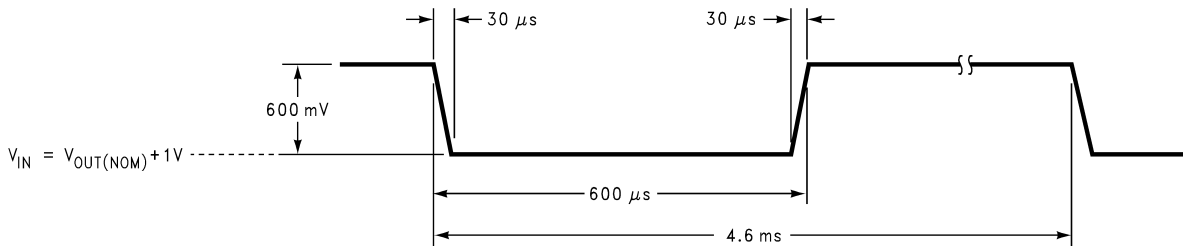

20020508

**FIGURE 2. Line Transient response Input Perturbation**

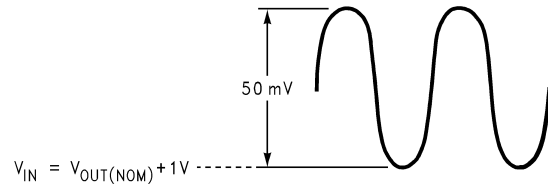

20020509

**FIGURE 3. PSRR Input Perturbation**

**Typical Performance Characteristics** Unless otherwise specified,  $C_{IN} = C_{OUT} = 1 \mu F$  Ceramic,  $V_{IN} = V_{OUT} + 0.2V$ ,  $T_A = 25^\circ C$ , Enable pin is tied to  $V_{IN}$ .

**Ripple Rejection Ratio (LP3988-2.6)**

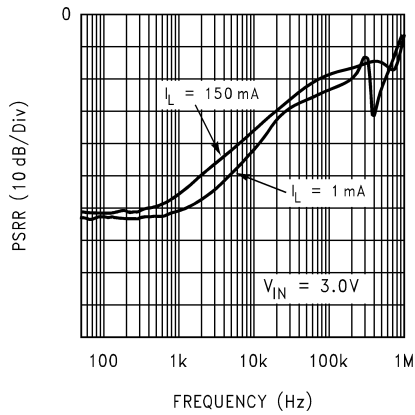

20020510

**Ripple Rejection Ratio (LM3988-2.6)**

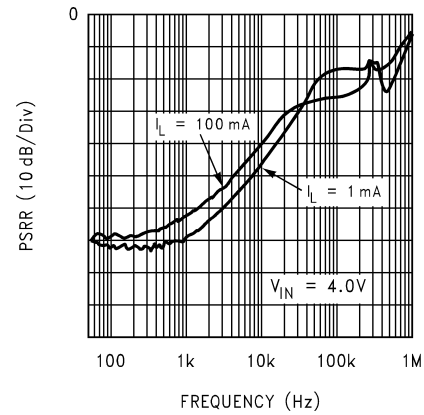

20020511

**Typical Performance Characteristics** Unless otherwise specified,  $C_{IN} = C_{OUT} = 1 \mu F$  Ceramic,  $V_{IN} = V_{OUT} + 0.2V$ ,  $T_A = 25^\circ C$ , Enable pin is tied to  $V_{IN}$ . (Continued)

**Power-Good Response Time (LP3988-2.85)**  
(flag pin pulled to  $V_{OUT}$  through a  $100k\Omega$  resistor)

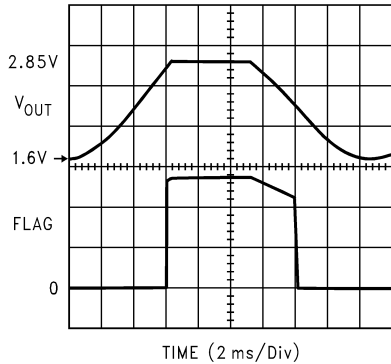

20020512

**Power-Good Response Time (LP3988-2.85)**  
(flag pin pulled to  $V_{IN}$  through a  $100k\Omega$  resistor)

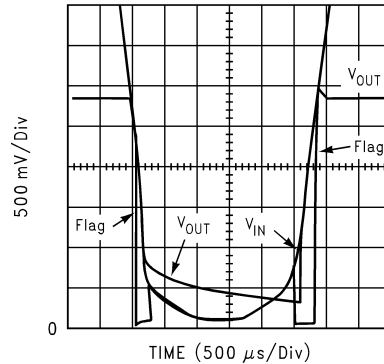

20020513

**Power-Good Response Time (LP3988-2.85)**  
(flag pin pulled to  $V_{OUT}$  through a  $100k\Omega$  resistor)

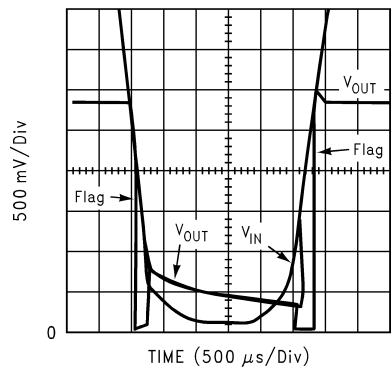

20020514

**Line Transient Response (LP3988-2.85)**

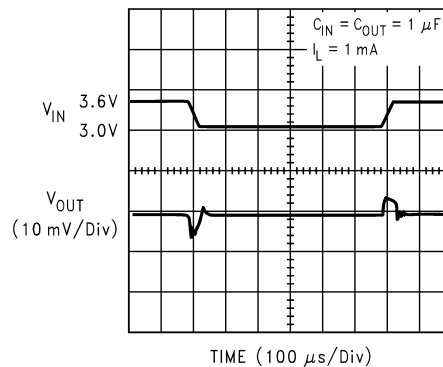

20020515

**Line Transient Response (LP3988-2.85)**

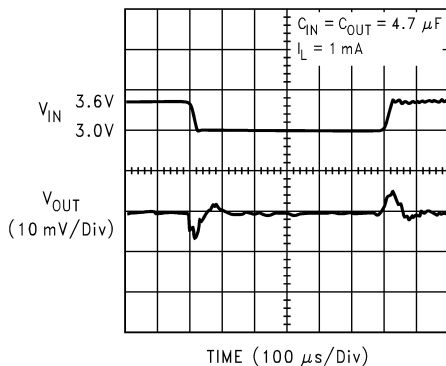

20020516

**Power-Up Response**

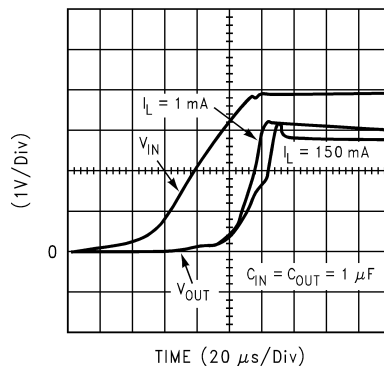

20020517

**Typical Performance Characteristics** Unless otherwise specified,  $C_{IN} = C_{OUT} = 1 \mu F$  Ceramic,  $V_{IN} = V_{OUT} + 0.2V$ ,  $T_A = 25^\circ C$ , Enable pin is tied to  $V_{IN}$ . (Continued)

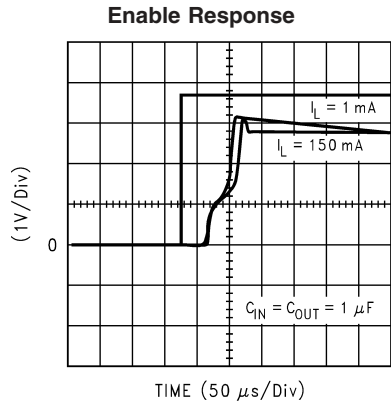

20020518

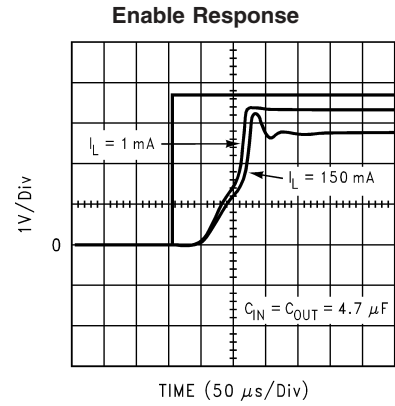

20020519

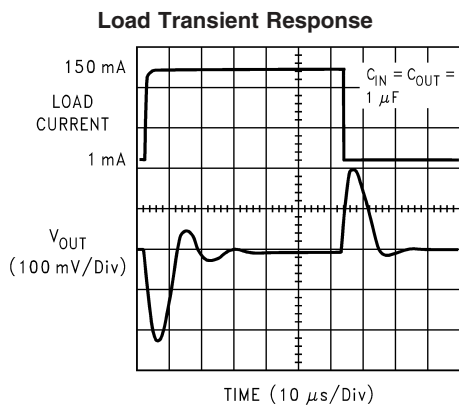

20020520

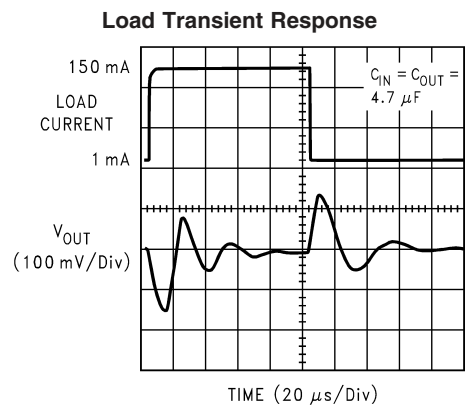

20020521



## Application Hints

### EXTERNAL CAPACITORS

Like any low-dropout regulator, the LP3988 requires external capacitors for regulator stability. The LP3988 is specifically designed for portable applications requiring minimum board space and smallest components. These capacitors must be correctly selected for good performance.

### INPUT CAPACITOR

An input capacitance of  $\approx 1\mu\text{F}$  is required between the LP3988 input pin and ground (the amount of the capacitance may be increased without limit).

This capacitor must be located a distance of not more than 1cm from the input pin and returned to a clean analog ground. Any good quality ceramic, tantalum, or film capacitor may be used at the input.

**Important:** Tantalum capacitors can suffer catastrophic failures due to surge current when connected to a low-impedance source of power (like a battery or a very large capacitor). If a tantalum capacitor is used at the input, it must be guaranteed by the manufacturer to have a surge current rating sufficient for the application.

There are no requirements for the ESR on the input capacitor, but tolerance and temperature coefficient must be considered when selecting the capacitor to ensure the capacitance will be  $\approx 1\mu\text{F}$  over the entire operating temperature range.

### OUTPUT CAPACITOR

The LP3988 is designed specifically to work with very small ceramic output capacitors. A ceramic capacitor (dielectric types Z5U, Y5V or X7R) in 1 to 22  $\mu\text{F}$  range with 5m $\Omega$  to 500m $\Omega$  ESR range is suitable in the LP3988 application circuit.

It may also be possible to use tantalum or film capacitors at the output, but these are not as attractive for reasons of size and cost (see next section Capacitor Characteristics).

The output capacitor must meet the requirement for minimum amount of capacitance and also have an ESR (Equivalent Series Resistance) value which is within a stable range (5 m $\Omega$  to 500 m $\Omega$ ).

### NO-LOAD STABILITY

The LP3988 will remain stable and in regulation with no external load. This is specially important in CMOS RAM keep-alive applications.

### CAPACITOR CHARACTERISTICS

The LP3988 is designed to work with ceramic capacitors on the output to take advantage of the benefits they offer: for capacitance values in the range of 1 $\mu\text{F}$  to 4.7 $\mu\text{F}$  range, ceramic capacitors are the smallest, least expensive and have the lowest ESR values (which makes them best for eliminating high frequency noise). The ESR of a typical 1 $\mu\text{F}$  ceramic capacitor is in the range of 20 m $\Omega$  to 40 m $\Omega$ , which easily meets the ESR requirement for stability by the LP3988.

The ceramic capacitor's capacitance can vary with temperature. Most large value ceramic capacitors ( $\approx 2.2\mu\text{F}$ ) are manufactured with Z5U or Y5V temperature characteristics, which results in the capacitance dropping by more than 50% as the temperature goes from 25°C to 85°C.

A better choice for temperature coefficient in a ceramic capacitor is X7R, which holds the capacitance within  $\pm 15\%$ .

Tantalum capacitors are less desirable than ceramic for use as output capacitors because they are more expensive when comparing equivalent capacitance and voltage ratings in the 1 $\mu\text{F}$  to 4.7 $\mu\text{F}$  range.

Another important consideration is that tantalum capacitors have higher ESR values than equivalent size ceramics. This means that while it may be possible to find a tantalum capacitor with an ESR value within the stable range, it would have to be larger in capacitance (which means bigger and more costly) than a ceramic capacitor with the same ESR value. It should also be noted that the ESR of a typical tantalum will increase about 2:1 as the temperature goes from 25°C down to -40°C, so some guard band must be allowed.

### ON/OFF INPUT OPERATION

The LP3988 is turned off by pulling the  $V_{\text{EN}}$  pin low, and turned on by pulling it high. If this feature is not used, the  $V_{\text{EN}}$  pin should be tied to  $V_{\text{IN}}$  to keep the regulator output on at all time. To assure proper operation, the signal source used to drive the  $V_{\text{EN}}$  input must be able to swing above and below the specified turn-on/off voltage thresholds listed in the Electrical Characteristics section under  $V_{\text{IL}}$  and  $V_{\text{IH}}$ .

### FAST ON-TIME

The LP3988 utilizes a speed up circuitry to ramp up the internal  $V_{\text{REF}}$  voltage to its final value to achieve a fast output turn on time.

# Physical Dimensions inches (millimeters)

unless otherwise noted

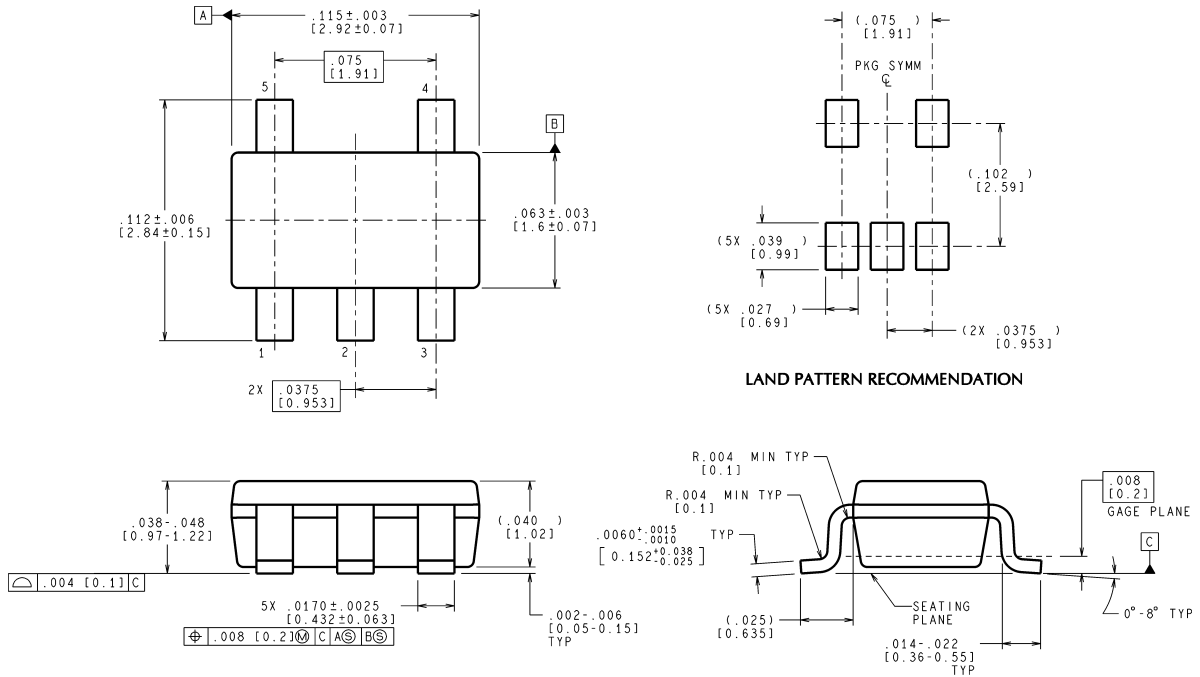

CONTROLLING DIMENSION IS INCH  
VALUES IN [ ] ARE MILLIMETERS

MF05A (Rev B)

## 5-Lead Small Outline Package (MF) NS Package Number MF05A

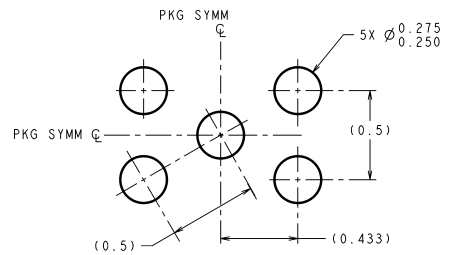

DIMENSIONS ARE IN MILLIMETERS  
DIMENSIONS IN ( ) FOR REFERENCE ONLY

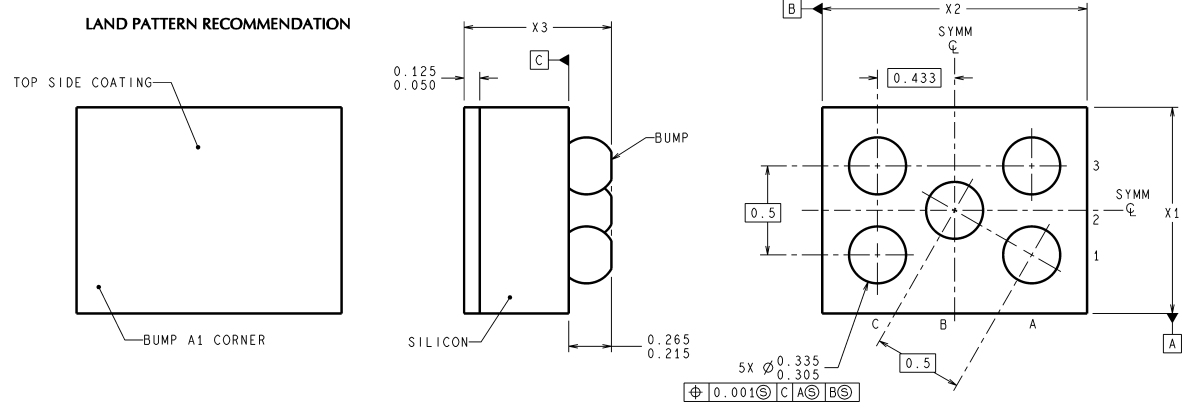

## Thin micro SMD, 5 bump Package (TLA05) NS Package Number TLA05AEA

The dimensions for X1, X2 and X3 are as given:  
X1 = 1.006mm +/- 0.03mm  
X2 = 1.463mm +/- 0.03mm  
X3 = 0.6mm +/- 0.075mm

TLA05XXX (Rev B)

## Notes

### LIFE SUPPORT POLICY

NATIONAL'S PRODUCTS ARE NOT AUTHORIZED FOR USE AS CRITICAL COMPONENTS IN LIFE SUPPORT DEVICES OR SYSTEMS WITHOUT THE EXPRESS WRITTEN APPROVAL OF THE PRESIDENT AND GENERAL COUNSEL OF NATIONAL SEMICONDUCTOR CORPORATION. As used herein:

1. Life support devices or systems are devices or systems which, (a) are intended for surgical implant into the body, or (b) support or sustain life, and whose failure to perform when properly used in accordance with instructions for use provided in the labeling, can be reasonably expected to result in a significant injury to the user.
2. A critical component is any component of a life support device or system whose failure to perform can be reasonably expected to cause the failure of the life support device or system, or to affect its safety or effectiveness.

### BANNED SUBSTANCE COMPLIANCE

National Semiconductor certifies that the products and packing materials meet the provisions of the Customer Products Stewardship Specification (CSP-9-111C2) and the Banned Substances and Materials of Interest Specification (CSP-9-111S2) and contain no "Banned Substances" as defined in CSP-9-111S2.



**National Semiconductor**  
Americas Customer  
Support Center  
Email: [new.feedback@nsc.com](mailto:new.feedback@nsc.com)  
Tel: 1-800-272-9959

**National Semiconductor**  
Europe Customer Support Center  
Fax: +49 (0) 180-530 85 86  
Email: [europe.support@nsc.com](mailto:europe.support@nsc.com)  
Deutsch Tel: +49 (0) 69 9508 6208  
English Tel: +44 (0) 870 24 0 2171  
Français Tel: +33 (0) 1 41 91 8790

**National Semiconductor**  
Asia Pacific Customer  
Support Center  
Email: [ap.support@nsc.com](mailto:ap.support@nsc.com)

**National Semiconductor**  
Japan Customer Support Center  
Fax: 81-3-5639-7507  
Email: [jpn.feedback@nsc.com](mailto:jpn.feedback@nsc.com)  
Tel: 81-3-5639-7560

[www.national.com](http://www.national.com)