

# BCP53 Series

## PNP Silicon Epitaxial Transistors

This PNP Silicon Epitaxial transistor is designed for use in audio amplifier applications. The device is housed in the SOT-223 package which is designed for medium power surface mount applications.

- High Current: 1.5 Amps
- NPN Complement is BCP56
- The SOT-223 Package can be soldered using wave or reflow. The formed leads absorb thermal stress during soldering, eliminating the possibility of damage to the die
- Device Marking:  
BCP53T1 = AH  
BCP53-10T1 = AH-10  
BCP53-16T1 = AH-16
- Pb-Free Packages are Available

### MAXIMUM RATINGS (T<sub>C</sub> = 25°C unless otherwise noted)

Rating	Symbol	Value	Unit
Collector-Emitter Voltage	V <sub>CEO</sub>	-80	Vdc
Collector-Base Voltage	V <sub>CBO</sub>	-100	Vdc
Emitter-Base Voltage	V <sub>EBO</sub>	-5.0	Vdc
Collector Current	I <sub>C</sub>	1.5	Adc
Total Power Dissipation @ T <sub>A</sub> = 25°C (Note 1.) Derate above 25°C	P <sub>D</sub>	1.5 12	Watts mW/°C
Operating and Storage Temperature Range	T <sub>J</sub> , T <sub>stg</sub>	-65 to +150	°C

### THERMAL CHARACTERISTICS

Characteristic	Symbol	Max	Unit
Thermal Resistance, Junction to Ambient (surface mounted)	R <sub>θJA</sub>	83.3	°C/W
Lead Temperature for Soldering, 0.0625" from case Time in Solder Bath	T <sub>L</sub>	260 10	°C Sec

Stresses exceeding Maximum Ratings may damage the device. Maximum Ratings are stress ratings only. Functional operation above the Recommended Operating Conditions is not implied. Extended exposure to stresses above the Recommended Operating Conditions may affect device reliability.

1. Device mounted on a glass epoxy printed circuit board 1.575 in. x 1.575 in. x 0.059 in.; mounting pad for the collector lead min. 0.93 sq. in.



**ON Semiconductor®**

<http://onsemi.com>

## MEDIUM POWER HIGH CURRENT SURFACE MOUNT PNP TRANSISTORS

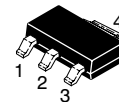
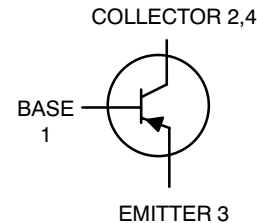

**SOT-223  
CASE 318E  
STYLE 1**

### MARKING DIAGRAM

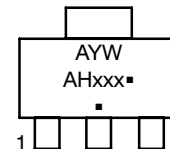

AHxxx = Device Code  
xxx = -10 or -16  
A = Assembly Location  
Y = Year  
W = Work Week  
▪ = Pb-Free Package

(Note: Microdot may be in either location)

### ORDERING INFORMATION

Device	Package	Shipping†
BCP53T1	SOT-223	1000/Tape & Reel
BCP53T1G	SOT-223 (Pb-Free)	1000/Tape & Reel
BCP53-10T1	SOT-223	1000/Tape & Reel
BCP53-10T1G	SOT-223 (Pb-Free)	1000/Tape & Reel
BCP53-16T1	SOT-223	1000/Tape & Reel
BCP53-16T1G	SOT-223 (Pb-Free)	1000/Tape & Reel
BCP53-16T3	SOT-223	4000/Tape & Reel
BCP53-16T3G	SOT-223 (Pb-Free)	4000/Tape & Reel

†For information on tape and reel specifications, including part orientation and tape sizes, please refer to our Tape and Reel Packaging Specifications Brochure, BRD8011/D.

# BCP53 Series

## ELECTRICAL CHARACTERISTICS ( $T_A = 25^\circ\text{C}$ unless otherwise noted)

Characteristics	Symbol	Min	Typ	Max	Unit
<b>OFF CHARACTERISTICS</b>					
Collector-Base Breakdown Voltage ( $I_C = -100 \mu\text{Adc}$ , $I_E = 0$ )	$V_{(BR)CBO}$	-100	-	-	Vdc
Collector-Emitter Breakdown Voltage ( $I_C = -1.0 \text{ mAdc}$ , $I_B = 0$ )	$V_{(BR)CEO}$	-80	-	-	Vdc
Collector-Emitter Breakdown Voltage ( $I_C = -100 \mu\text{Adc}$ , $R_{BE} = 1.0 \text{ kohm}$ )	$V_{(BR)CER}$	-100	-	-	Vdc
Emitter-Base Breakdown Voltage ( $I_E = -10 \mu\text{Adc}$ , $I_C = 0$ )	$V_{(BR)EBO}$	-5.0	-	-	Vdc
Collector-Base Cutoff Current ( $V_{CB} = -30 \text{ Vdc}$ , $I_E = 0$ )	$I_{CBO}$	-	-	-100	nAdc
Emitter-Base Cutoff Current ( $V_{EB} = -5.0 \text{ Vdc}$ , $I_C = 0$ )	$I_{EBO}$	-	-	-10	$\mu\text{Adc}$
<b>ON CHARACTERISTICS</b>					
DC Current Gain ( $I_C = -5.0 \text{ mAdc}$ , $V_{CE} = -2.0 \text{ Vdc}$ ) All Part Types ( $I_C = -150 \text{ mAdc}$ , $V_{CE} = -2.0 \text{ Vdc}$ )	$h_{FE}$	25	-	-	-
		40	-	250	
		63	-	160	
		100	-	250	
		25	-	-	
Collector-Emitter Saturation Voltage ( $I_C = -500 \text{ mAdc}$ , $I_B = -50 \text{ mAdc}$ )	$V_{CE(sat)}$	-	-	-0.5	Vdc
Base-Emitter On Voltage ( $I_C = -500 \text{ mAdc}$ , $V_{CE} = -2.0 \text{ Vdc}$ )	$V_{BE(on)}$	-	-	-1.0	Vdc
<b>DYNAMIC CHARACTERISTICS</b>					
Current-Gain - Bandwidth Product ( $I_C = -10 \text{ mAdc}$ , $V_{CE} = -5.0 \text{ Vdc}$ , $f = 35 \text{ MHz}$ )	$f_T$	-	50	-	MHz

## TYPICAL ELECTRICAL CHARACTERISTICS

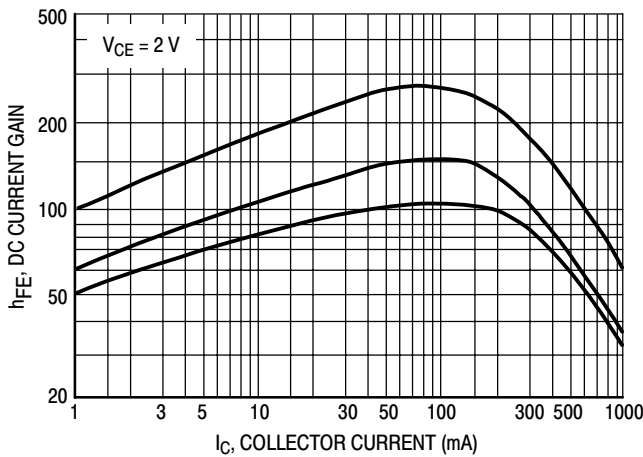

Figure 1. DC Current Gain

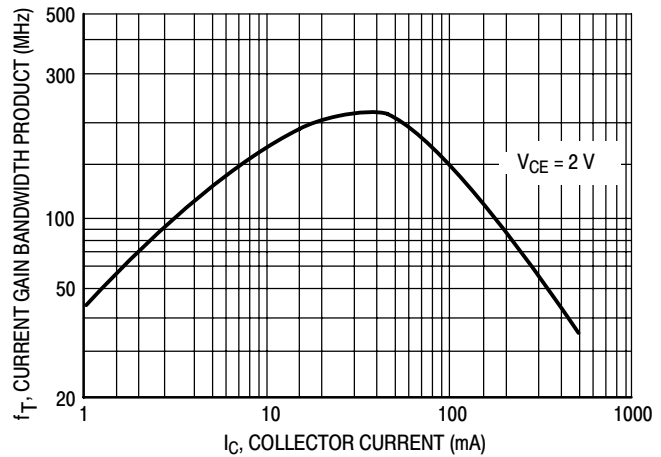

Figure 2. Current Gain Bandwidth Product

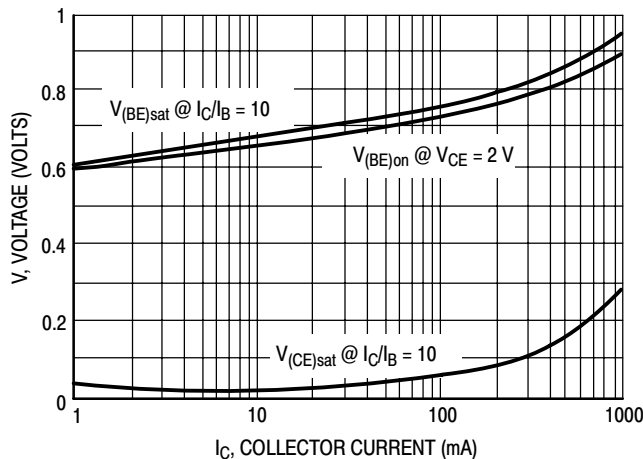

Figure 3. Saturation and "ON" Voltages

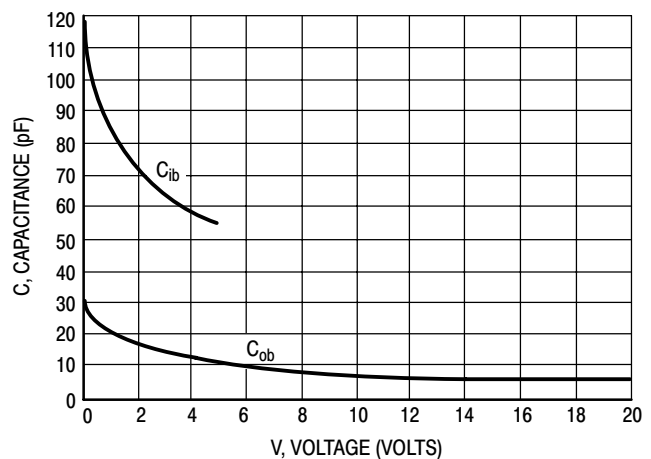
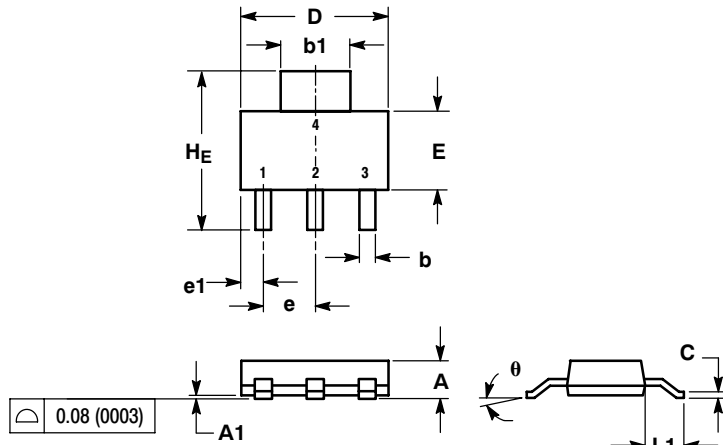

Figure 4. Capacitances

# BCP53 Series

## PACKAGE DIMENSIONS

SOT-223  
CASE 318E-04  
ISSUE K



- NOTES:
1. DIMENSIONING AND TOLERANCING PER ANSI Y14.5M, 1982.
  2. CONTROLLING DIMENSION: INCH.

DIM	MILLIMETERS			INCHES		
	MIN	NOM	MAX	MIN	NOM	MAX
A	1.50	1.63	1.75	0.060	0.064	0.068
A1	0.02	0.06	0.10	0.001	0.002	0.004
b	0.60	0.75	0.89	0.024	0.030	0.035
b1	2.90	3.06	3.20	0.115	0.121	0.126
c	0.24	0.29	0.35	0.009	0.012	0.014
D	6.30	6.50	6.70	0.249	0.256	0.263
E	3.30	3.50	3.70	0.130	0.138	0.145
e	2.20	2.30	2.40	0.087	0.091	0.094
e1	0.85	0.94	1.05	0.033	0.037	0.041
L1	1.50	1.75	2.00	0.060	0.069	0.078
HE	6.70	7.00	7.30	0.264	0.276	0.287
θ	0°	-	10°	0°	-	10°

- STYLE 1:  
PIN 1. BASE  
2. COLLECTOR  
3. EMITTER  
4. COLLECTOR

### SOLDERING FOOTPRINT\*

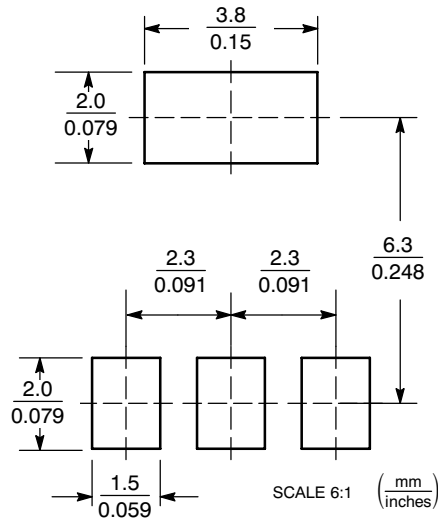

\*For additional information on our Pb-Free strategy and soldering details, please download the ON Semiconductor Soldering and Mounting Techniques Reference Manual, SOLDERRM/D.

ON Semiconductor and are registered trademarks of Semiconductor Components Industries, LLC (SCILLC). SCILLC reserves the right to make changes without further notice to any products herein. SCILLC makes no warranty, representation or guarantee regarding the suitability of its products for any particular purpose, nor does SCILLC assume any liability arising out of the application or use of any product or circuit, and specifically disclaims any and all liability, including without limitation special, consequential or incidental damages. "Typical" parameters which may be provided in SCILLC data sheets and/or specifications can and do vary in different applications and actual performance may vary over time. All operating parameters, including "Typicals" must be validated for each customer application by customer's technical experts. SCILLC does not convey any license under its patent rights nor the rights of others. SCILLC products are not designed, intended, or authorized for use as components in systems intended for surgical implant into the body, or other applications intended to support or sustain life, or for any other application in which the failure of the SCILLC product could create a situation where personal injury or death may occur. Should Buyer purchase or use SCILLC products for any such unintended or unauthorized application, Buyer shall indemnify and hold SCILLC and its officers, employees, subsidiaries, affiliates, and distributors harmless against all claims, costs, damages, and expenses, and reasonable attorney fees arising out of, directly or indirectly, any claim of personal injury or death associated with such unintended or unauthorized use, even if such claim alleges that SCILLC was negligent regarding the design or manufacture of the part. SCILLC is an Equal Opportunity/Affirmative Action Employer. This literature is subject to all applicable copyright laws and is not for resale in any manner.

### PUBLICATION ORDERING INFORMATION

**LITERATURE FULFILLMENT:**  
Literature Distribution Center for ON Semiconductor  
P.O. Box 5163, Denver, Colorado 80217 USA  
Phone: 303-675-2175 or 800-344-3860 Toll Free USA/Canada  
Fax: 303-675-2176 or 800-344-3867 Toll Free USA/Canada  
Email: orderlit@onsemi.com

**N. American Technical Support:** 800-282-9855 Toll Free  
USA/Canada  
**Europe, Middle East and Africa Technical Support:**  
Phone: 421 33 790 2910  
**Japan Customer Focus Center**  
Phone: 81-3-5773-3850

**ON Semiconductor Website:** [www.onsemi.com](http://www.onsemi.com)  
**Order Literature:** <http://www.onsemi.com/orderlit>  
For additional information, please contact your local Sales Representative

BCP53T1/D