

**OBSOLETE:**

 FOR INFORMATION PURPOSES ONLY  
 Contact Linear Technology for Potential Replacement

**FEATURES**

- Accurate Preset 3.3V Output
- Up to 87% Efficiency
- Optional Burst Mode™ Operation for Light Loads
- Can Be Used with Many LTC Switching ICs
- **Accurate Ultra-Low-Loss Current Limit**
- **Operates with Inputs from 4.5V to 30V**
- **Shutdown Mode Draws Only 15µA**
- Uses Small 30µH Inductor

**APPLICATIONS**

- Laptop and Palmtop Computers
- Portable Data-Gathering Instruments

**DESCRIPTION**

The LT®1432-3.3 is a control chip designed to operate with the LT1171/LT1271 family of switching regulators to make a very high efficiency 3.3V step-down (buck) switching regulator. A minimum of external components is needed.

Included is an accurate current limit which uses only 60mV sense voltage and uses “free” PC board trace material for the sense resistor. Logic controlled electronic shutdown mode draws only 15µA battery current. The switching regulator operates down to 4.5V input.

The LT1432-3.3 has a logic controlled Burst Mode operation to achieve high efficiency at very light load currents (0mA to 100mA) such as memory keep-alive. In normal switching mode, the standby power loss is about 30mW, limiting efficiency at light loads. In Burst Mode operation, standby loss is reduced to approximately 11mW. Output current in this mode is typically in the 5mA to 100mA range.

The LT1432-3.3 is available in 8-pin SO and PDIP packages. The LT1171/LT1271 is also available in surface mount DD packages.

LT, LTC and LT are registered trademarks of Linear Technology Corporation.  
 Burst Mode is a trademark of Linear Technology Corporation.

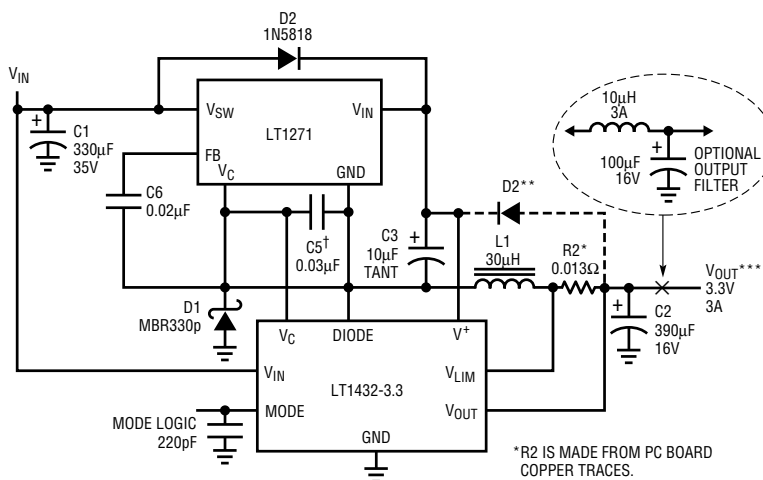
**TYPICAL APPLICATION**

<0.3V = NORMAL MODE  
 >2.5V = SHUTDOWN  
 OPEN = Burst Mode OPERATION

† FOR CIRCUITS WHICH DO NOT USE Burst Mode OPERATION, C5 MAY BE PARALLEL WITH A 680Ω, 0.1µF IN SERIES TO GIVE WIDE PHASE MARGIN WITH DIFFERENT SWITCHING ICs AND OUTPUT CAPACITORS

\*R2 IS MADE FROM PC BOARD COPPER TRACES.

\*\*OPTIONAL CONNECTION FOR D2. EFFICIENCY IS HIGHER, BUT MINIMUM INCREASES. SEE APPLICATION INFORMATION SECTION.

\*\*\*MAXIMUM CURRENT IS DETERMINED BY THE CHOICE OF LT1071 FAMILY MAIN SWITCHER IC. SEE APPLICATION INFORMATION SECTION.

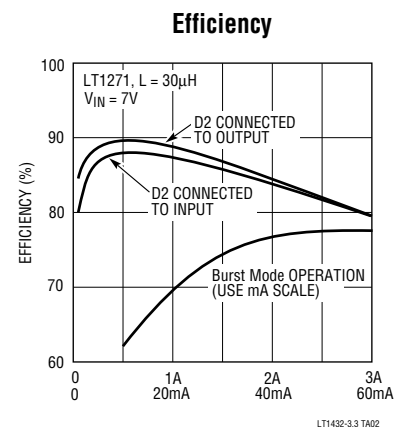

Figure 1. High Efficiency 5V Buck Converter

**ABSOLUTE MAXIMUM RATINGS**

$V_{IN}$ Pin .....	30V
$V^+$ Pin .....	40V
$V_C$ .....	35V
$V_{LIM}$ and $V_{OUT}$ Pins .....	7V
Diode Pin Voltage .....	30V
Mode Pin Current (Note 2) .....	1mA
Operating Temperature Range .....	0°C to 70°C
Storage Temperature Range .....	-65°C to 150°C
Lead Temperature (Soldering, 10 sec) .....	300°C

**PACKAGE/ORDER INFORMATION**

<p>TOP VIEW</p> <p>N8 PACKAGE 8-LEAD PDIP</p> <p>S8 PACKAGE 8-LEAD PLASTIC SO</p> <p><math>T_{JMAX} = 100^{\circ}C, \theta_{JA} = 150^{\circ}C/W</math> (N8) <math>T_{JMAX} = 100^{\circ}C, \theta_{JA} = 170^{\circ}C/W</math> (S8)</p>	<p>ORDER PART NUMBER</p> <p>LT1432CN8-3.3 LT1432CS8-3.3</p>
--	---

Consult factory for Military and Industrial grade parts.

**ELECTRICAL CHARACTERISTICS**

$V_C = 4V, V_{IN} = 4V, V^+ = 8V, V_{DIODE} = \text{Open}, V_{LIM} = V_{OUT}, V_{MODE} = 0V, T_J = 25^{\circ}C$   
 Device is in standard test loop unless otherwise noted.

PARAMETER	CONDITIONS	MIN	TYP	MAX	UNITS	
Regulated Output Voltage	$V_C$ Current = 220 $\mu$ A	●	3.24	3.30	3.36	V
Output Voltage Line Regulation	$V_{IN} = 4V$ to 30V	●	5	20	mV	
Input Supply Current (Note 1)	$V_{IN} = 4V$ to 30V, $V^+ = V_{IN} + 5V, V_C = V_{IN} + 1V$	●	0.3	0.5	mA	
Quiescent Output Load Current			0.9	1.2	mA	
Mode Pin Current	$V_{MODE} = 0V$ (Current Is Out of Pin) $V_{MODE} = 3.3V$ (Shutdown)	● ●	30 15	50 30	$\mu$ A $\mu$ A	
Mode Pin Threshold Voltage (Normal to Burst)	$I_{MODE} = 10\mu$ A (Out of Pin)	●	0.6	0.9	1.5	V
$V_C$ Pin Saturation Voltage	$V_{OUT} = 3.6V$ (Forced)	●	0.25	0.45	V	
$V_C$ Pin Maximum Sink Current	$V_{OUT} = 3.6V$ (Forced)	●	0.45	0.8	1.5	mA
$V_C$ Pin Source Current	$V_{OUT} = 3.0V$ (Forced)	●	35	60	100	$\mu$ A
Current Limit Sense Voltage (Note 3)	Device in Current Limit Loop		56	60	64	mV
$V_{LIM}$ Pin Current	Device in Current Limit Loop (Current Is Out of Pin)	●	30	45	70	$\mu$ A
Supply Current in Shutdown	$V_{MODE} > 3V, V_{IN} < 30V, V_C$ and $V^+ = 0V$		15	60	$\mu$ A	
Burst Mode Operation Output Ripple	Device in Burst Test Circuit		100		mV <sub>p-p</sub>	
Burst Mode Operation Average Output Voltage	Device in Burst Test Circuit	●	3.15	3.30	3.45	V
Clamp Diode Forward Voltage	$I_F = 1mA$ , All Other Pins Open	●	0.5	0.65	V	
Start-up Drive Current	$V_{OUT} = 1.5V$ (Forced), $V_{IN} = 4V$ to 26V, $V^+ = V_{IN} - 1V, V_C = V_{IN} - 1.5V$	●	30	45	mA	
Restart Time Delay	(Note 4)		0.7	1.2	10	ms
Transconductance, Output to $V_C$ Pin	$I_C = 150\mu$ A to 250 $\mu$ A	●	2700	3600	5000	$\mu$ mho

# ELECTRICAL CHARACTERISTICS

Operating parameters in standard circuit configuration.

$V_{IN} = 7V$ ,  $I_{OUT} = 0$ , unless otherwise noted. These parameters guaranteed where indicated, but not tested.

PARAMETER	CONDITIONS	MIN	TYP	MAX	UNITS
Burst Mode Operation Quiescent Input Supply Current			1.6	2.2	mA
Burst Mode Operation Output Ripple Voltage	$I_{OUT} = 0$ $I_{OUT} = 50mA$		80 120		mV <sub>p-p</sub> mV <sub>p-p</sub>
Normal Mode Equivalent Input Supply Current	Extrapolated from $I_{OUT} = 20mA$		3.0		mA
Normal Mode Minimum Operating Input Voltage	$100mA < I_{OUT} < 1.5A$		4.5		V
Burst Mode Operation Minimum Operating Input Voltage	$5mA < I_{OUT} < 50mA$	4.1		V	
Efficiency	Normal Mode $I_{OUT} = 0.5A$ Burst Mode Operation $I_{OUT} = 25mA$		86 70		% %
Load Regulation	Normal Mode $50mA < I_{OUT} < 2A$ Burst Mode Operation $0 < I_{OUT} < 50mA$		5 30	15	mV mV

The ● denotes specifications which apply over the full operating temperature range.

**Note 1:** Does not include current drawn by the power IC. See operating parameters in standard circuit.

**Note 2:** Breakdown voltage on the Mode pin is 7V. External current must be limited to value shown.

**Note 3:** Current limit sense voltage temperature coefficient is +0.33%/°C to match TC of copper trace material.

**Note 4:**  $V_{OUT}$  pin switched from 3.6V to 3.0V.

# EQUIVALENT SCHEMATIC

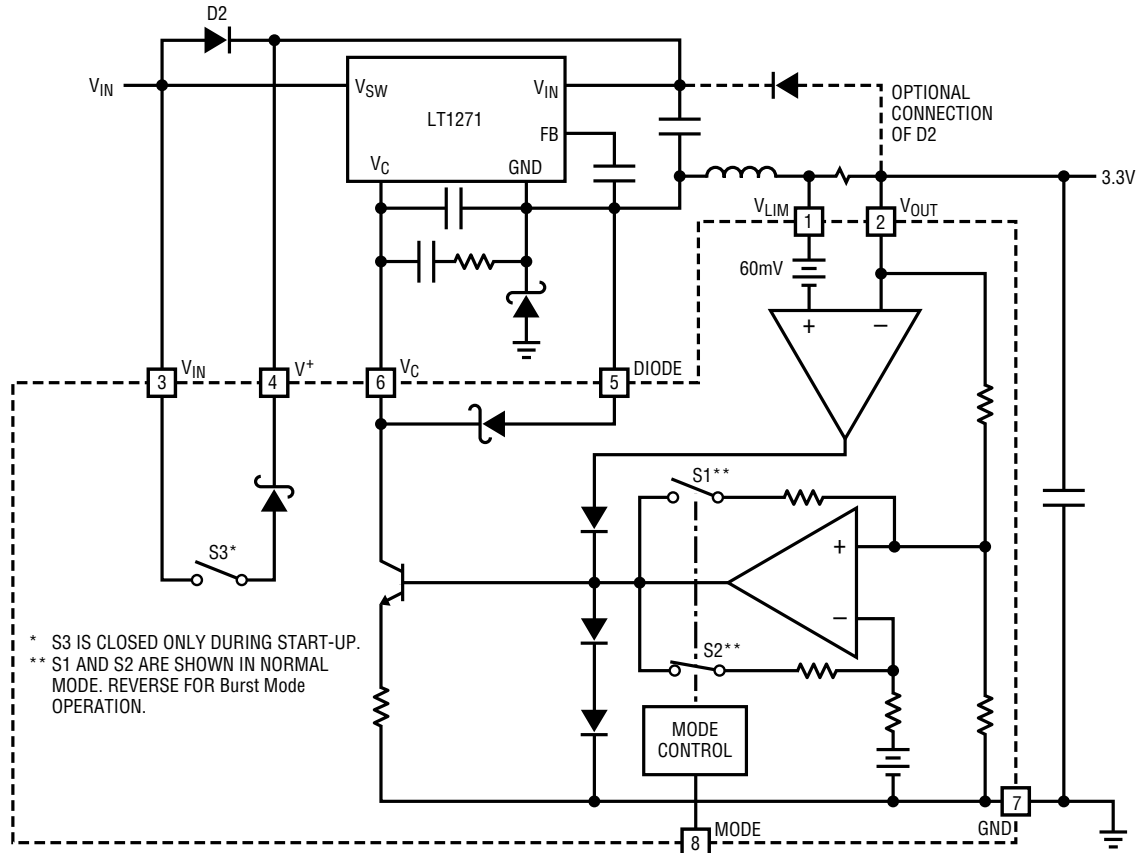
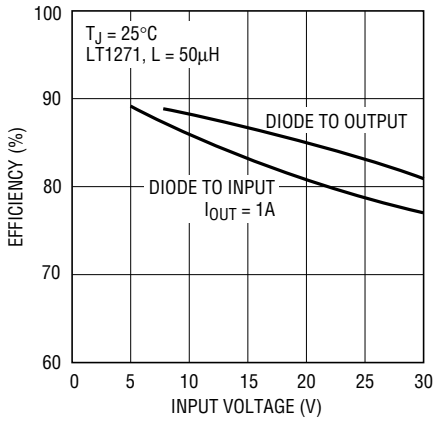

Figure 2

LT1432-3.3 F02

# TYPICAL PERFORMANCE CHARACTERISTICS

**Efficiency vs Input Voltage**



LT1432-3.3 G01

**Efficiency vs Load Current**

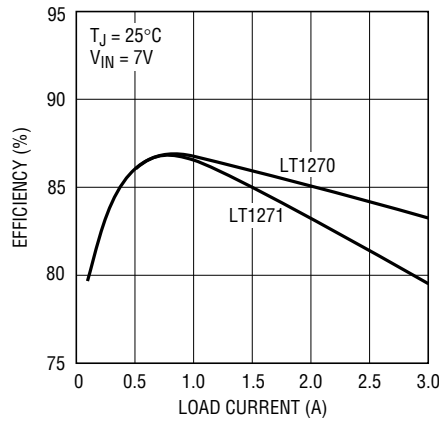

LT1432-3.3 G02

**Minimum Input Voltage to Start – Normal Mode (Diode to Input)**

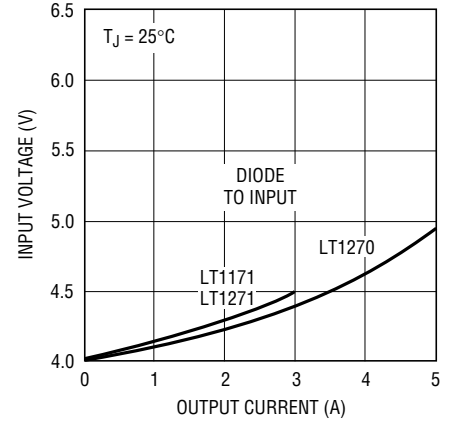

LT1432-3.3 G03

**Minimum Input Voltage – Normal Mode (Diode to Output)**

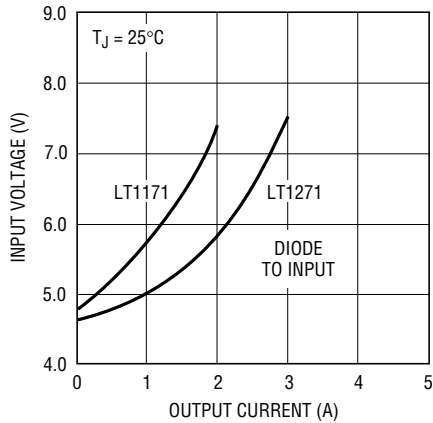

LT1432-3.3 G04

**Minimum Running Voltage – Normal Mode\***

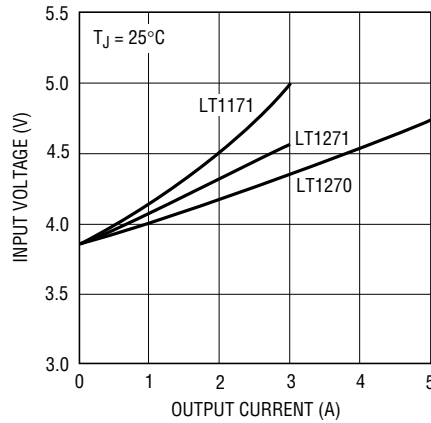

LT1432-3.3 G05

**Burst Mode Operation Minimum Input Voltage**

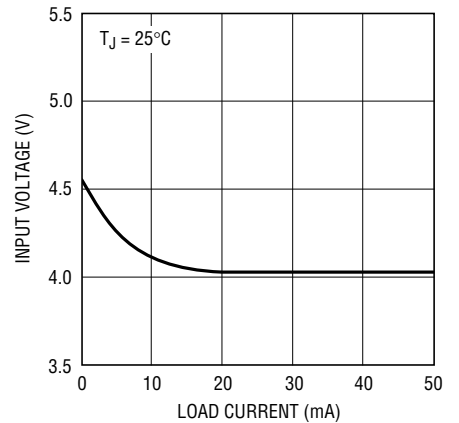

LT1432-3.3 G06

\*SEE MINIMUM INPUT VOLTAGE TO START

**Shutdown Current vs Input Voltage**

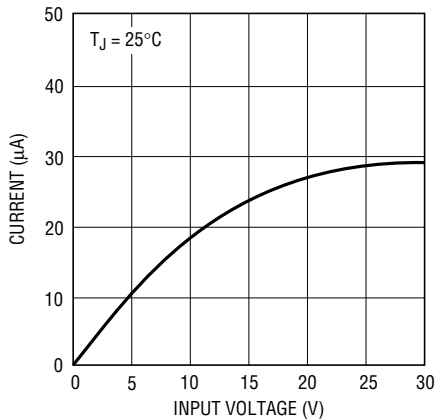

LT1432-3.3 G07

**Battery Current in Shutdown\***

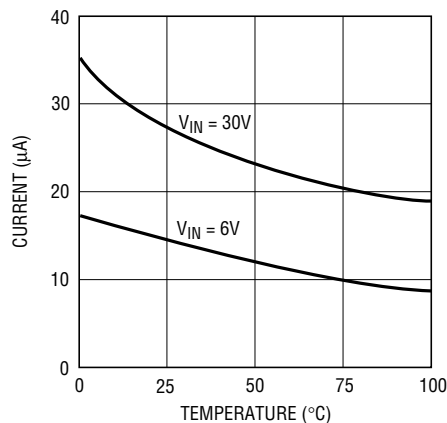

LT1432-3.3 G08

\*DOES NOT INCLUDE LT1271 SWITCH LEAKAGE.

**Current Limit Sense Voltage\***

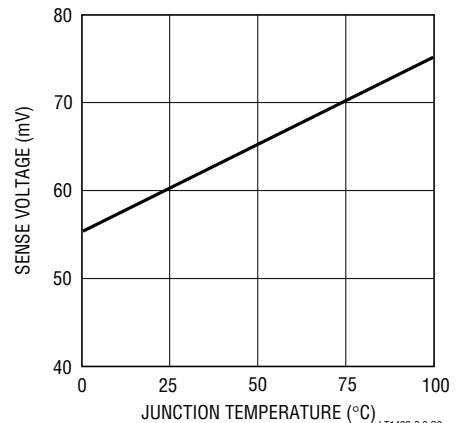

LT1432-3.3 G9

\* TEMPERATURE COEFFICIENT OF SENSE VOLTAGE IS DESIGNED TO TRACK COPPER RESISTANCE.

# TYPICAL PERFORMANCE CHARACTERISTICS

**Incremental Battery Current \* in Burst Mode Operation**

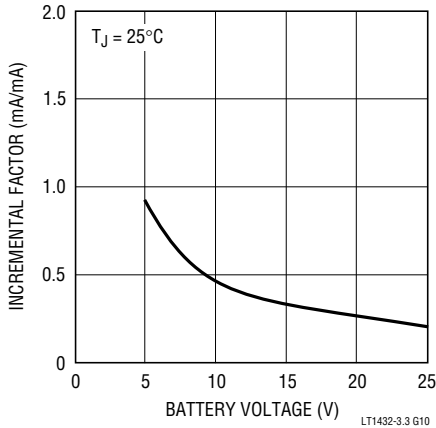

\* TO CALCULATE TOTAL BATTERY CURRENT IN Burst Mode OPERATION, MULTIPLY LOAD CURRENT BY INCREMENTAL FACTOR AND ADD NO-LOAD CURRENT.

**No Load Battery Current in Burst Mode Operation**

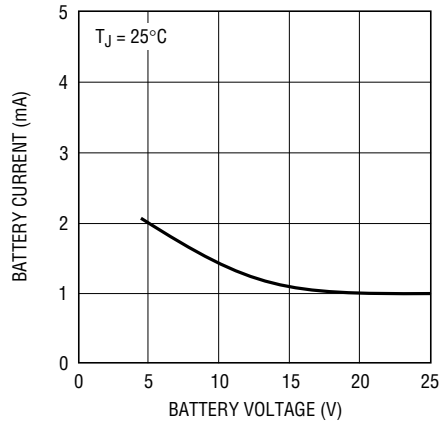

**Transconductance –  $V_{OUT}$  to  $V_C$  Current**

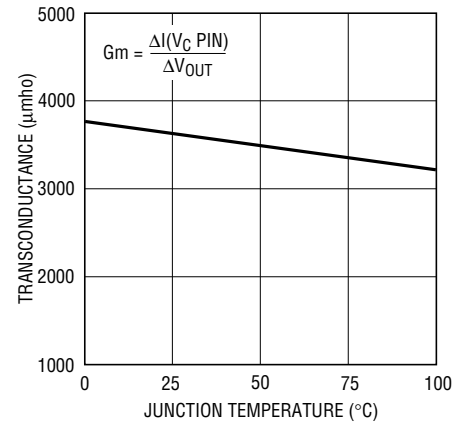

**Line Regulation**

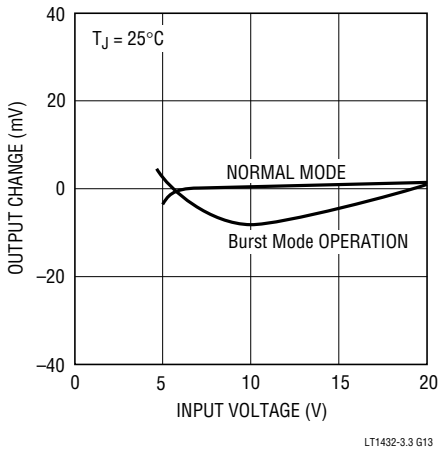

**Burst Mode Operation Load Regulation**

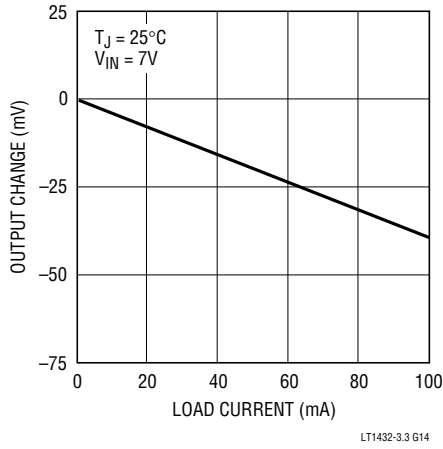

**Mode Pin Current**

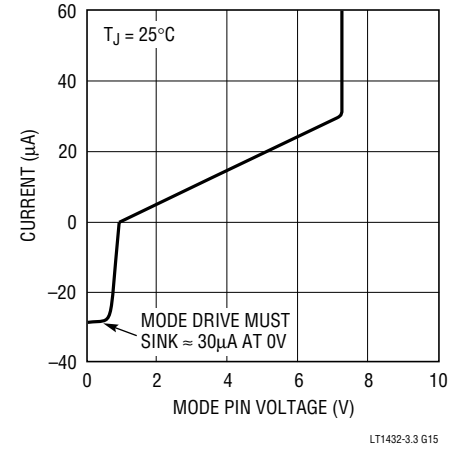

**Restart Load Current**

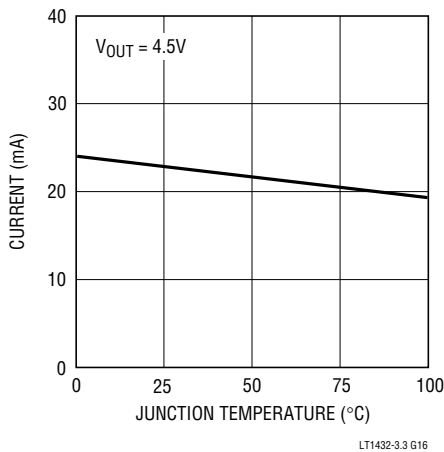

**Restart Time Delay**

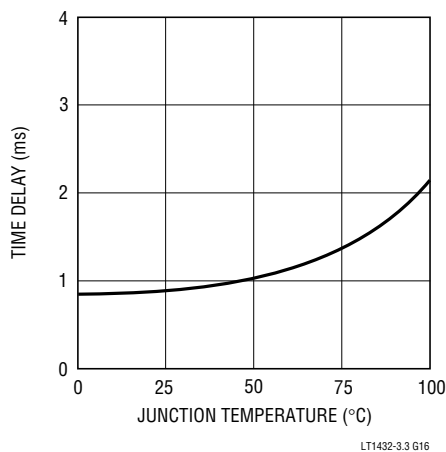

**Start-up Switch Characteristics**

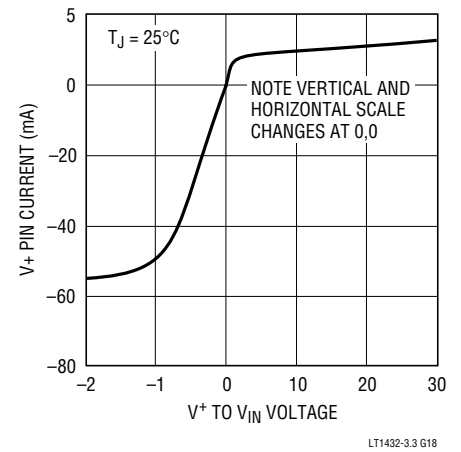

## APPLICATIONS INFORMATION

More applications information on the LT1432-3.3 is available in the LT1432 data sheet.

### Basic Circuit Description

The LT1432-3.3 is a dedicated 3.3V buck converter driver chip intended to be used with an IC switcher from the LT1171/LT1271 family. This family of current mode switchers includes current ratings from 1.25A to 10A, and switching frequencies from 40kHz to 100kHz as shown in the table below.

DEVICE	SWITCH CURRENT	FREQUENCY	OUTPUT CURRENT IN BUCK CONVERTER
LT1270A	10A	60kHz	7.5A
LT1270	8A	60kHz	6A
LT1170	5A	100kHz	3.75A
LT1070	5A	40kHz	3.75A
LT1269	4A	100kHz	3A
LT1271	4A	60kHz	3A
LT1171	2.5A	100kHz	1.8A
LT1071	2.5A	40kHz	1.8A
LT1172	1.25A	100kHz	0.9A
LT1072	1.25A	40kHz	0.9A

The maximum load current which can be delivered by these chips in a buck converter is approximately 75% of their switch current rating. This is partly due to the fact that buck converters must operate at very high duty cycles when input voltage is low. The current mode nature of the LT1271 family requires an internal reduction of peak current limit at high duty cycles, so these devices are rated at only 80% of their full current rating when duty cycle is 80%. A second factor is inductor ripple current, half of which subtracts from maximum available load current. The LT1271 family was originally intended for topologies which have the negative side of the switch grounded, such as boost converters. It has an extremely efficient quasi-saturating NPN switch which mimics the linear resistive nature of a MOSFET but consumes much less die area. Driver losses are kept to a minimum with a patented adaptive antisat drive that maintains a forced beta of 40 over a wide range of switch currents. This family is attractive for high efficiency buck converters because of the low switch loss, but to operate as a positive buck converter, the GND pin of the IC must be floated to act as the switch output node. This requires a floating power supply for the chip and some means for level shifting the feedback signal. The LT1432-3.3 performs these functions as well as adding

current limiting, micropower shutdown, and dual mode operation for high conversion efficiency with both heavy and very light loads.

The circuit in Figure 1 is a basic 3.3V positive buck converter which can operate with input voltage from 4.5V to 30V. The power switch is located between the  $V_{SW}$  pin and GND pin on the LT1271. Its current and duty cycle are controlled by the voltage on the  $V_C$  pin with respect to the GND pin. This voltage ranges from 1V to 2V as switch current increases from zero to full-scale. Correct output voltage is maintained by the LT1432-3.3 which has an internal reference and error amplifier (see Equivalent Schematic in Figure 2). The amplifier output is level shifted with an internal open collector NPN to drive the  $V_C$  pin of the switcher. The normal resistor divider feedback to the switcher feedback pin cannot be used because the feedback pin is referenced to the GND pin, which is switching up and down. The Feedback pin (FB) is simply bypassed with a capacitor. This forces the switcher  $V_C$  pin to swing high with about 200 $\mu$ A sourcing capability. The LT1432-3.3  $V_C$  pin then sinks this current to control the loop. Transconductance from the regulator output to the  $V_C$  pin current is controlled to approximately 3600 $\mu$ mhos by local feedback around the LT1432-3.3 error amplifier (S2 closed in Figure 2). This is done to simplify frequency compensation of the overall loop. **A word of caution about the FB pin bypass capacitor (C6): this capacitor value is very non-critical, but the capacitor must be connected directly to the GND pin or tab of the switcher to avoid differential spikes created by fast switch currents flowing in the external PCB traces. This is also true for the frequency compensation capacitor C5. C5 forms the dominant loop pole.**

A floating power supply for the switcher is generated by D2 and C3 which peak detect the input voltage during switch off time. This is different than the 5V version of the LT1432 which connects the anode of the diode to the output rather than the input. The output connection is more efficient because the floating voltage is a constant 5V (or 3.3V), independent of input voltage, but in the case of the 3.3V circuit, minimum required input voltage for starting is several volts higher (see the Typical Performance Characteristics curves). When the diode is connected to the input, the suggested type is a

## APPLICATIONS INFORMATION

Schottky 1N5818. Diode type is more critical for the output connection because the high capacitance of Schottky diodes creates narrow output spikes. These spikes will be eliminated if a secondary output filter is used or if there is sufficient lead length between the regulator output and the load bypass capacitors. Low capacitance diodes like the 1N4148 do not create large spikes, but their high forward resistance requires even higher input voltage to start.

D1, L1 and C2 act as the conventional catch diode and output filter of the buck converter. These components should be selected carefully to maintain high efficiency and acceptable output ripple. See the original LT1432 (5V) data sheet for detailed discussions of these parts.

Current limiting is performed by R2. Sense voltage is only 60mV to maintain high efficiency. This also reduces the value of the sense resistor enough to utilize a printed circuit board trace as the sense resistor. The sense voltage has a positive temperature coefficient of 0.33%/°C to match the temperature coefficient of copper.

The basic regulator has three different operating modes, defined by the Mode pin drive. Normal operation occurs when the Mode pin is grounded. A low quiescent current Burst Mode operation can be initiated by floating the Mode pin. Input supply current is typically 1.3mA in this mode, and output ripple voltage is 100mV<sub>p-p</sub>. Pulling the Mode pin above 2.5V forces the entire regulator into micropower shutdown where it typically draws less than 20μA.

### Burst Mode Operation

Burst Mode operation is initiated by allowing the Mode pin to float, where it will assume a DC voltage of approximately 1V. If AC pickup from surrounding logic lines is likely, the Mode pin should be bypassed with a 200pF capacitor. Burst Mode operation is used to reduce quiescent operating current when the regulator output current is very low, as in sleep mode in a lap-top computer. In this mode, hysteresis is added to the error amplifier to make it switch on and off, rather than maintain a constant amplifier output. This forces the switching IC to either provide a rapidly increasing current or to go into full micropower shutdown. Current is delivered to the output capacitor in pulses of higher amplitude and low duty cycle rather than a continuous stream of low amplitude

pulses. This maximizes efficiency at light load by eliminating quiescent current in the switching IC during the period between bursts.

The result of pulsating currents into the output capacitor is that output ripple amplitude increases and ripple frequency becomes a function of load current. The typical output ripple in Burst Mode operation is 100mV<sub>p-p</sub>, and ripple frequency can vary from 50Hz to 2kHz. This is not normally a problem for the logic circuits which are kept alive during sleep mode.

Some thought must be given to proper sequencing between normal mode and Burst Mode operation. A heavy (>100mA) load in Burst Mode operation can cause excessive output ripple, and an abnormally light load (10mA to 30mA, see Figure 3) in *normal* mode can cause the regulator to revert to a quasi-Burst Mode operation that also has higher output ripple. The worst condition is a sudden, large increase in load current (>100mA) during this quasi-Burst Mode operation or just after a switch from Burst Mode operation to normal mode. This can cause the output to sag badly while the regulator is establishing normal mode operation (≈100μs). To avoid problems, it is suggested that the power-down sequence consist of reducing load current to below 100mA, but greater than the minimum for normal mode, then switching to Burst Mode operation, followed by a reduction of load current to the final sleep value. Power-up would consist of increasing the load current to the minimum for

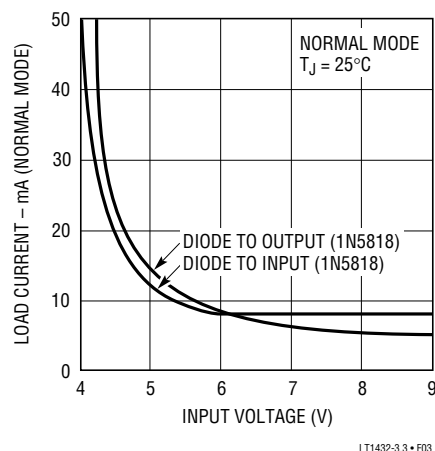

Figure 3. Minimum Normal Mode Load Current



## APPLICATIONS INFORMATION

normal mode, then switching to normal mode, pausing for 1ms, followed by return to full load.

If this sequence is not possible, an alternative is to increase the output capacitor to  $> 680\mu\text{F}$ . This modification will often allow the power-down sequence to consist of simultaneous turn-off of load current and switch to Burst Mode operation. Power-up is accomplished by switching to normal mode and simultaneously increasing load current to the lowest possible value (30mA to 500mA), followed by a short pause and return to full load current.

### Full Shutdown

When the Mode pin is driven high, full shutdown of the regulator occurs. Regulator input current will then consist of the LT1432 shutdown current ( $\approx 15\mu\text{A}$ ) plus the switch leakage of the switching IC ( $\approx 1\mu\text{A}$  to  $25\mu\text{A}$ ). Mode input current ( $\approx 15\mu\text{A}$  at 5V) must also be considered. Start-up from shutdown can be in either normal or Burst Mode operation, but one should always check start-up overshoot, especially if the output capacitor or frequency compensation components have been changed.

## PACKAGE DESCRIPTION Dimensions in inches (millimeters) unless otherwise noted.

### N8 Package 8-Lead Plastic DIP

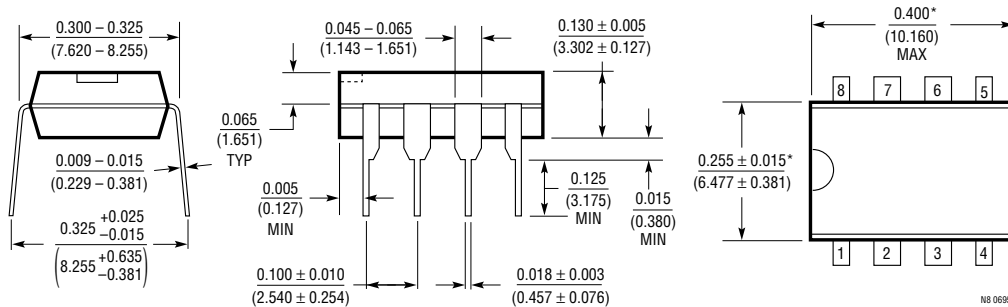

\*THESE DIMENSIONS DO NOT INCLUDE MOLD FLASH OR PROTRUSIONS.  
MOLD FLASH OR PROTRUSIONS SHALL NOT EXCEED 0.010 INCH (0.254mm)

### S8 Package 8-Lead Plastic SOIC

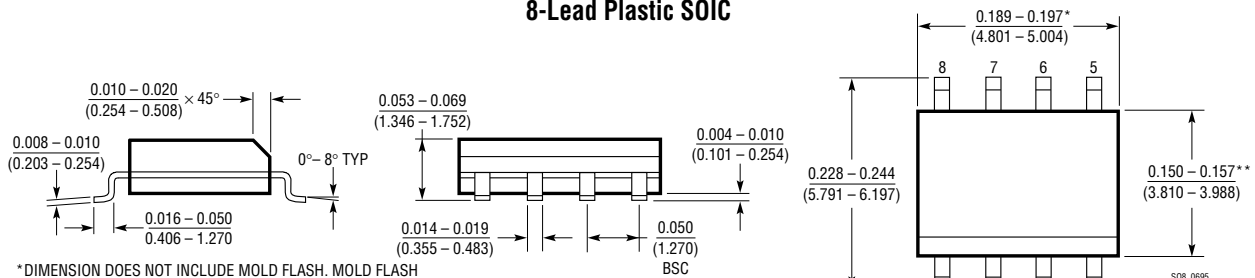

\* DIMENSION DOES NOT INCLUDE MOLD FLASH. MOLD FLASH SHALL NOT EXCEED 0.006" (0.152mm) PER SIDE  
\*\* DIMENSION DOES NOT INCLUDE INTERLEAD FLASH. INTERLEAD FLASH SHALL NOT EXCEED 0.010" (0.254mm) PER SIDE

## RELATED PARTS

PART NUMBER	DESCRIPTION	COMMENTS
LTC1148	High Efficiency Step-Down Switching Regulator Controller	5V Regulated Output Voltage
LT1432	High Efficiency Synchronous Step-Down Switching Regulator	Adjustable and Fixed 5V or 3.3V Outputs
LT1507	1.5A, 500kHz Step-Down Switching Regulator	Fixed Frequency PWM for Low Input Voltages from 4.5V to 12V