

High Performance Voltage Comparators

IL311

LOGIC DIAGRAM

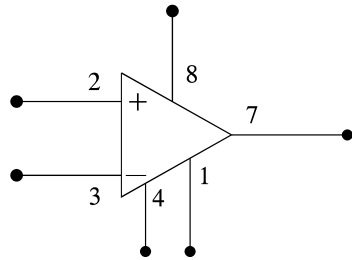

Input polarity is reversed when GND pin is used as an output.

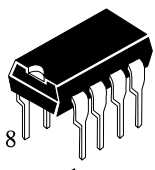

N SUFFIX
PLASTIC

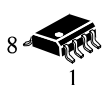

D SUFFIX
SOIC

ORDERING INFORMATION
 IL311N Plastic
 IL311D SOIC
 $T_A = -45^{\circ}\text{C}$ to 85°C for all packages

PIN ASSIGNMENT

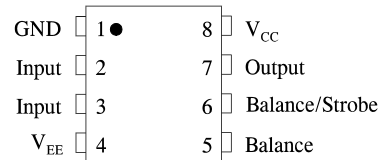

MAXIMUM RATINGS

Symbol	Parameter	Value	Unit
$V_{CC} + V_{EE} $	Total Supply Voltage	36	V
$V_O - V_{EE}$	Output to Negative Supply Voltage	40	V
V_{EE}	Ground to Negative Supply Voltage	30	V
V_{ID}	Input Differential Voltage	± 30	V
V_{IN}	Input Voltage (Note)	± 15	V
-	Voltage at Strobe Pin	V_{CC} to $V_{CC} - 5$	V
P_D	Power Dissipation and Thermal Characteristics Plastic Dual In-Line Packages Derate above $T_A = +25^{\circ}\text{C}$	625	mW
$1/\theta_{JA}$		5.0	mW/ $^{\circ}\text{C}$
$T_{J(max)}$	Operating Junction Temperature	+150	$^{\circ}\text{C}$
Tstg	Storage Temperature Range	-60 to +150	$^{\circ}\text{C}$

Note: This rating applies for ± 15 volt supplies. The positive input voltage limit is 30 volts above the negative supply. The negative input voltage limit is equal to the negative supply voltage or 30 volts below the positive supply, whichever is less.

RECOMMENDED OPERATING CONDITIONS

Symbol	Parameter	Min	Max	Unit
$V_{CC+} V_{EE}$	Total Supply Voltage		30	V
T_A	Operating Temperature, All Package Types	- 45	+85	°C

ELECTRICAL CHARACTERISTICS ($V_{CC}=+15$ V, $V_{EE}= -15$ V, $T_A =+25$ °C unless otherwise noted [Note 1])

Symbol	Parameter	Test Conditions	Guaranteed Limits		Unit
			Min	Max	
V_{IO}	Input Offset Voltage (Note 2)	$R_S \leq 50$ k Ω , $T_A = +25$ °C $R_S \leq 50$ k Ω , -45 °C $\leq T_A \leq 85$ °C		7.5 10	mV
I_{IO}	Input Offset Current (Note 2)	$T_A = +25$ °C -45 °C $\leq T_A \leq 85$ °C		50 100	nA
I_{IB}	Input Bias Current	$T_A = +25$ °C $T_A = -45$ °C $T_A = +85$ °C		250 375 500	nA
A_V	Voltage Gain		150000		
t_{DLH}	Propagation Delay Time			300	ns
V_{DS}	Saturation Voltage	$T_A = +25$ °C $V_{ID} \leq -10$ mV, $I_O=50$ mA		1.5	V
V_{IR}	Input Voltage Range		-14.5	13.0	V
I_{CC}	Positive Supply Current			+7.5	mA
I_{EE}	Negative Supply Current			-5.0	mA

NOTES:

- Offset voltage, offset current and bias current specifications apply for a supply voltage range from a single 5.0 volt supply up to ± 15 volt supplies.
- The offset voltages and offset currents given are the maximum values required to drive the output within a volt of either supply with a 1.0 mA load. Thus, these parameters define an error band and take into account the “worst case” effects of voltage gain and input impedance.

**N SUFFIX PLASTIC DIP
(MS - 001BA)**

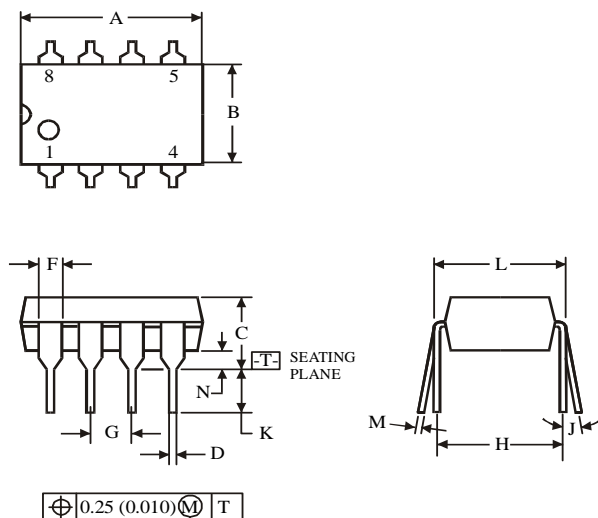
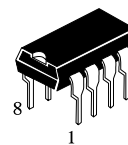

Symbol	Dimension, mm	
	MIN	MAX
A	8.51	10.16
B	6.1	7.11
C		5.33
D	0.36	0.56
F	1.14	1.78
G	2.54	
H	7.62	
J	0°	10°
K	2.92	3.81
L	7.62	8.26
M	0.2	0.36
N	0.38	

NOTES:

- Dimensions "A", "B" do not include mold flash or protrusions.
Maximum mold flash or protrusions 0.25 mm (0.010) per side.

**D SUFFIX SOIC
(MS - 012AA)**

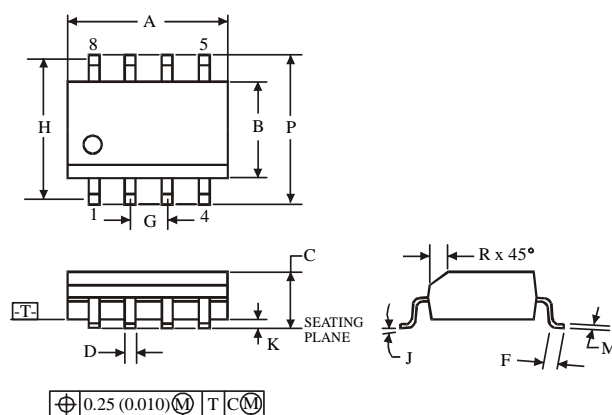
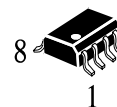

Symbol	Dimension, mm	
	MIN	MAX
A	4.8	5
B	3.8	4
C	1.35	1.75
D	0.33	0.51
F	0.4	1.27
G	1.27	
H	5.72	
J	0°	8°
K	0.1	0.25
M	0.19	0.25
P	5.8	6.2
R	0.25	0.5

NOTES:

- Dimensions A and B do not include mold flash or protrusion.
- Maximum mold flash or protrusion 0.15 mm (0.006) per side for A; for B - 0.25 mm (0.010) per side.