



# ICM7038 Family CMOS Analog Quartz Clock Circuit

## Synchronous Motor Applications

### FEATURES

- **Battery operation:** 1.2 to 3.6V devices
- **Very low power:** 30 $\mu$ A typical (1.5V parts)
- **High output current drive:** 1 mA minimum
- **Zero output bridge DC component** (50% duty cycle square wave)
- **All inputs fully protected** — no special handling precautions required
- **Wide operating temperature range:** -20°C to +70°C

### GENERAL DESCRIPTION

The ICM7038 family of synchronous motor drivers is designed to operate from a 1.5V battery, and performs the functions of oscillator, frequency divider and output driver. In addition a power driver is tapped off from the thirteenth divider for use as an alarm driver.

Specifically the ICM7038 family uses an inverter oscillator having all biasing components on chip. Binary dividers permit frequency division from 4 MHz down to 64 Hz. The output from the divider network drives a bridge output circuit which provides a 50% duty cycle AC square wave having virtually zero DC component for driving a synchronous single phase motor. The total output drivers saturation is typically 200 ohms providing efficient operation of synchronous motors. The alarm output will drive a transducer (piezoelectric or speaker).

### TABLE OF OPTIONS

The ICM7038 may be modified with alternative metal masks to provide any number of binary divider stages up to a maximum of 19 and supply voltages from 1.2 V to over 3.6V together with various output options. Consult your Intersil representative or the factory for further information. The alarm output can be tapped off from any of the latter divider stages.

(See table for standard options).

Part Number	Binary Dividers	Nominal Output Frequency	Nominal Supply Voltage
ICM7038A	16	64 Hz	3.0V
ICM7038B	16	64 Hz	1.5V

### PIN CONFIGURATION (OUTLINE DRAWING PA)

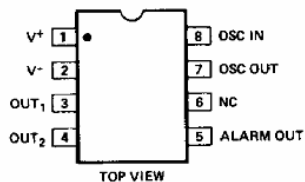

PIN 1 IS DESIGNATED BY EITHER A DOT OR A NOTCH.

### ORDERING INFORMATION

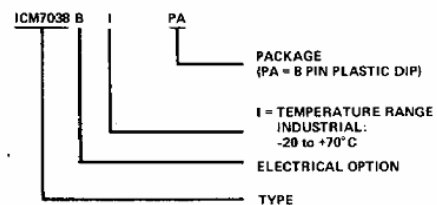

ORDER DEVICES BY FOLLOWING PART NUMBER —  
ICM7038B I PA

# ICM7038 Family



## ABSOLUTE MAXIMUM RATINGS

Power Dissipation Output Short Circuit(1) . . . . .	300mW
Supply Voltage:	
ICM7038A . . . . .	5V
ICM7038B . . . . .	3V
Output Voltage(2) . . . . .	V <sup>-</sup> to V <sup>+</sup>
Input Voltage(2) . . . . .	V <sup>-</sup> to V <sup>+</sup>
Storage Temperature . . . . .	-30°C to +125°C
Operating Temperature . . . . .	-20°C to +70°C

NOTE: Stresses above those listed under "Absolute Maximum Ratings" may cause permanent device failure. These are stress ratings only and functional operation of the devices at these or any other conditions above those indicated in the operation sections of this specification is not implied. Exposure to absolute maximum rating conditions for extended periods may cause device failures.

### NOTES:

1. This value of power dissipation refers to that of the package and will not be obtained under normal operating conditions.
2. Except for instantaneous static discharges all terminals may exceed the supply voltage (2.0V max) by ±0.5 volt provided that the currents in these terminals are limited to 2 mA each.

## TEST CIRCUIT

### QUARTZ CRYSTAL PARAMETERS

f = 4,194,304 Hz  
R<sub>S</sub> = 35Ω  
C<sub>m</sub> = 10 mpF  
C<sub>0</sub> = 3.5 pF

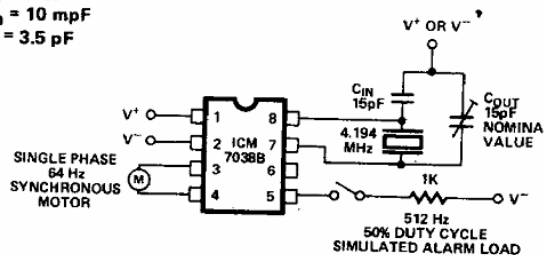

## OPERATING CHARACTERISTICS

(V<sup>+</sup> = 3.0V (ICM7038A) or 1.5V (ICM7038B), f<sub>osc</sub> = 4,194,304 Hz, test circuit 1, T<sub>A</sub> = 25°C, unless otherwise specified.

Parameter	Symbol	Conditions	7038A/C/F			7038B/D/E/G			Unit
			Min.	Typ.	Max.	Min.	Typ.	Max.	
Supply Current	I <sup>+</sup>			90	150		30	60	μA
Guaranteed Operating Voltage Range	V <sup>+</sup>	-20°C ≤ to ≤ 70°C	2.2		3.6	1.2		1.8	V
Total Output Saturation Resistance	R <sub>SAT</sub>	p + n Output Transistors, I <sub>OUT</sub> = 0.5mA		230	400		200	700	Ω
Alarm Output Saturation Resistance	R <sub>AL</sub>	I <sub>OUT</sub> = 1mA		200	400		300	800	Ω
Oscillator Stability	f <sub>STAB</sub>	Over V <sup>+</sup> range C <sub>IN</sub> = C <sub>OUT</sub> = 15pF		1			1		ppm
Oscillator Start-Up Time	t <sub>START</sub>	V <sup>+</sup> = min.			1.0			1.0	sec

# SCHEMATIC DIAGRAM (ICM7038B)

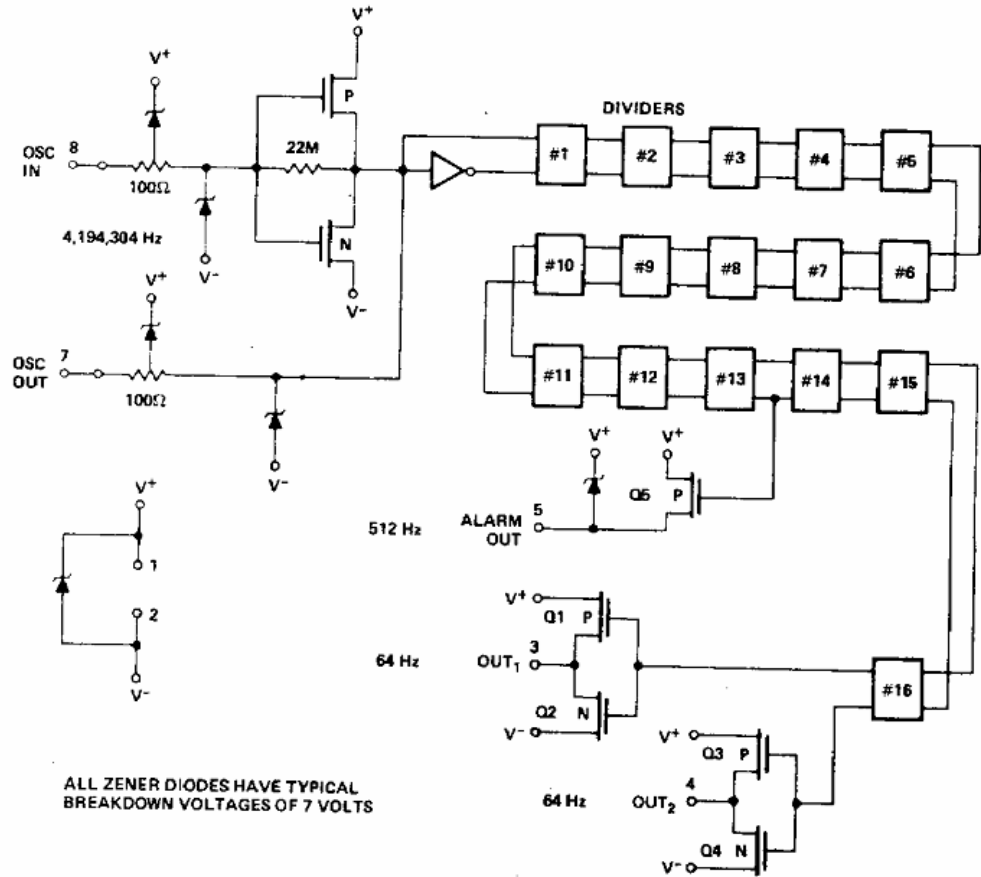

## ICM7038A



### TYPICAL OPERATING CHARACTERISTICS (ICM7038A)

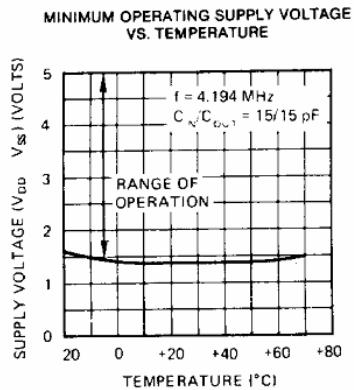
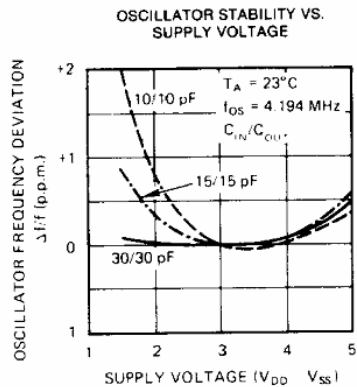

SUPPLY CURRENT VS. SUPPLY VOLTAGE

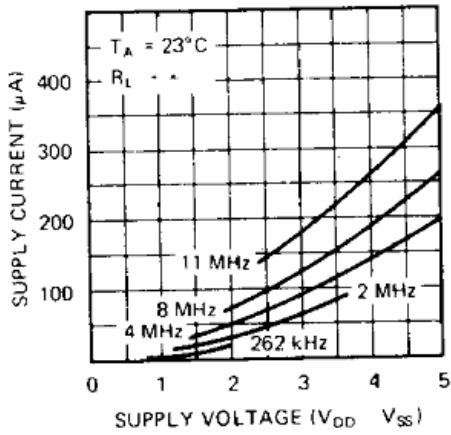

OUTPUT CURRENT VS. OUTPUT SATURATION VOLTAGE

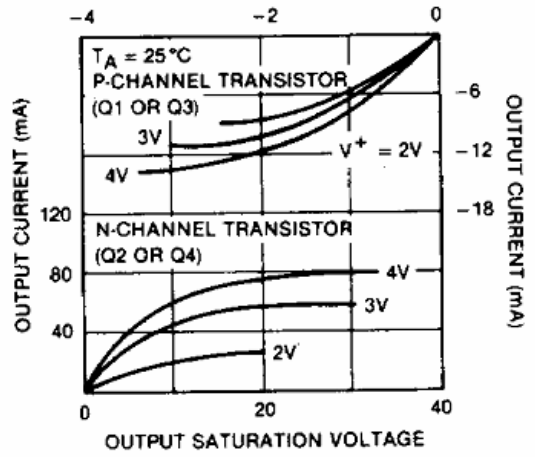

BRIDGE OUTPUT CURRENT VS. BRIDGE OUTPUT VOLTAGE

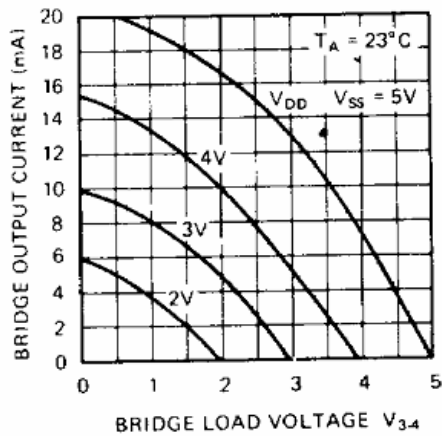

ALARM OUTPUT CURRENT (SOURCE) VS. OUTPUT SATURATION VOLTAGE

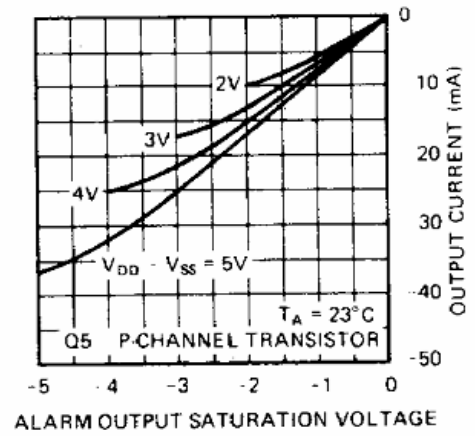

# ICM7038B



## TYPICAL OPERATING CHARACTERISTICS (ICM7038B)

### SUPPLY CURRENT VS. SUPPLY VOLTAGE

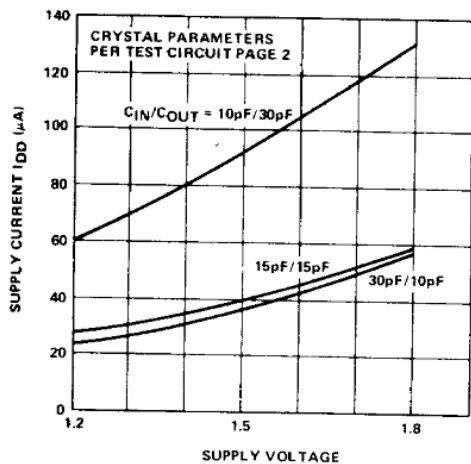

### ALARM OUTPUT CURRENT (SOURCE) VS. OUTPUT SATURATION VOLTAGE

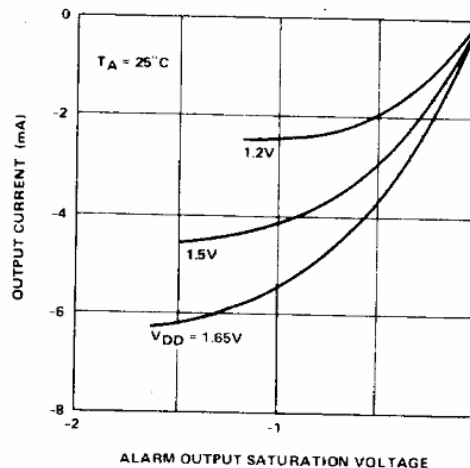

### OUTPUT CURRENT (SOURCE) VS. OUTPUT SATURATION VOLTAGE

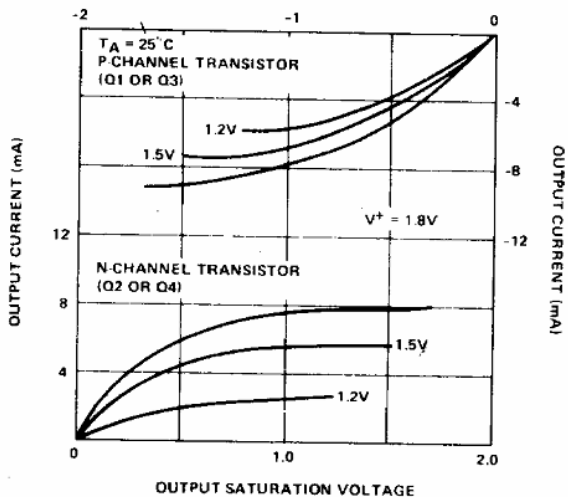

### OSCILLATOR STABILITY VS. SUPPLY VOLTAGE

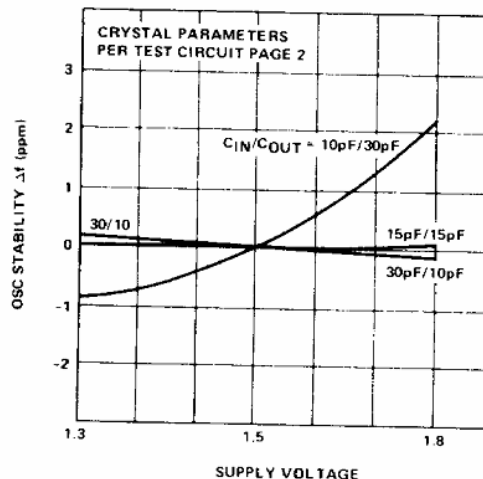

## BRIDGE OUTPUT CURRENT VS. BRIDGE OUTPUT VOLTAGE

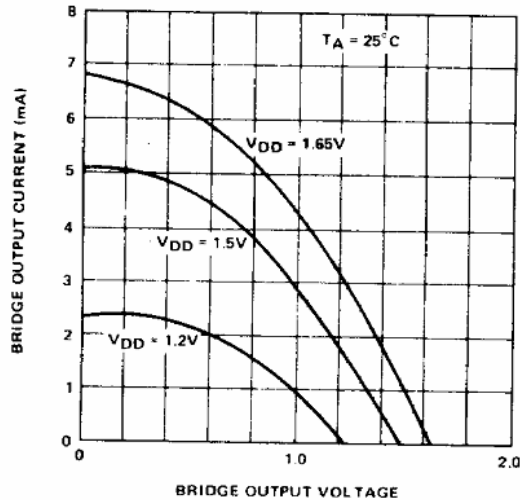

## MINIMUM OPERATING SUPPLY VOLTAGE VS. TEMPERATURE

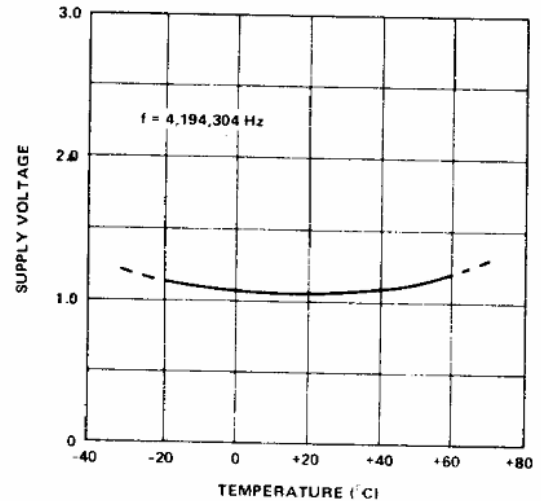

## ICM7038 Family

### APPLICATION NOTES

#### GENERAL DESCRIPTION

The ICM7038 Family has been designed primarily for quartz clock and timer applications using oscillator frequencies between 2.0 and 10 MHz. The design objectives were exceptional oscillator frequency stability, very low power, wide supply voltage range and wide temperature range. The oscillator contains all components except the tuning components and quartz crystal. Three outputs are provided. The two principal outputs are intended to be used to drive a single phase synchronous motor in a bridge configuration. As such, because of the matching of the transistors in the two outputs, the output DC component is extremely small. Stepper motors may also be used by placing a capacitor in series with the motor and using either a single output or the bridge output.

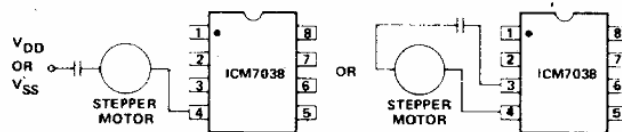

feedback resistor is provided on chip, which has a maximum value at start up. Oscillator tuning should be done at the oscillator output.

The following expressions can be used to arrive at a crystal specification:

Tuning Range

$$\frac{\Delta f}{f} = \frac{C_m}{2(C_0 + C_L)} \quad C_L = \frac{C_{IN}C_{OUT}}{C_{IN} + C_{OUT}}$$

$g_m$  required for startup

$$g_m = \omega^2 C_{IN}C_{OUT} R_s \left(1 + \frac{C_0}{C_L}\right)^2$$

$R_s$  = series resistance of the crystal

$f$  = frequency of the crystal

$\Delta f$  = frequency shift from series resonance frequency

$C_0$  = static capacitance of the crystal

$C_{IN}$  = input capacitance

$C_{OUT}$  = output capacitance

$C_L$  = load capacitance

$C_m$  = motional capacitance

$\omega = 2\pi f$

The resulting  $g_m$  should not exceed 50  $\mu\text{mhos}$

Alternatively outputs 3 and 4 may be used to drive TTL logic directly for timer applications.

The alarm output is taken from the output of the thirteenth divider and can source 1 mA at a low saturation voltage.

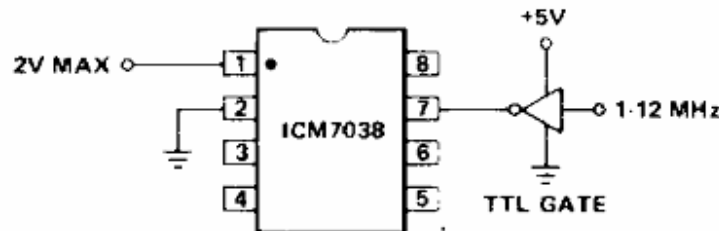

The ICM7038 may be used as a straight divider by driving directly into the oscillator output (pin no. 7) with a low impedance square wave drive. As such it may be used over the frequency range 1 MHz to 10 MHz.

## OSCILLATOR CONSIDERATIONS

The oscillator of the ICM7038 is designed to operate with crystals having a load capacitance of 10 to 12 pF. This allows nominal capacitor values of 15/15 pF or 20/20 pF. Increasing the load capacitance of the crystal requires larger oscillator device sizes, which causes the supply current to increase. Modifications to the oscillator can be made on a custom basis. The tuning range can be increased by using crystals with lower load capacitances, however, the stability may decrease somewhat. This can be counteracted by reducing the motional capacitance of the crystal. A non-linear