

ASMT-FJ30

Mini Surface Mount AF LED

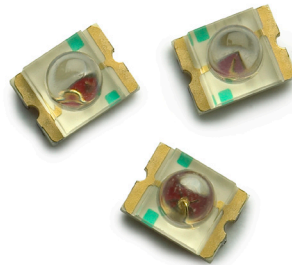

Data Sheet



Description

Avago Technologies' ASMT-FJ30-AB000 is a miniature SMT (Surface Mount Technology) dome lamp uses an untinted, non-diffused lens to provide a high luminous intensity within a narrow radiation pattern. The device environmental friendly green product of unique PCB based, namely Miniature Surface Mount AF LED.

This lamp type LED utilizes Aluminum Indium Gallium Phosphide (AlInGaP) material technology. The AlInGaP material has a very high luminous efficiency, capable of producing high light output over a wide range of drive currents. The color available for this SMT Lamp package is 612nm Orange.

This narrow angle SMT lamp package is designed for applications that require long distance illumination and narrow beam pattern such as auxiliary flash for auto-focus function in digital still camera etc. This miniature package is suitable for applications that have constraint in design area. In order to facilitate pick and place operation, this SMT Lamp is shipped in tape and reel, with 1500 units per reel.

This package is compatible with Pb-free reflow soldering process.

Features

- Smooth, Consistent Narrow Radiation Pattern
- 18° View Angle
- 3.2 L x 2.4 X 2.4H mm Package Dimension
- Good Intensity Output
- Compatible with 2x Solder Reflow
- Clear, Non-diffused Epoxy

Applications

- Camera

Eye Safety

These orange Miniature Surface Mount AF Lamps are use for camera application. The LEDs have lenses, which focus the beam at about 10mm from the front of the lens, from where the beam diverges relatively slowly. If the LEDs were placed in a product, they would create a Class 1 LED to IEC/EN 60825-1 (2001) at the recommended input current. As long as no collimating optics are added to the optical path.

CAUTION: ASMT-FJ30 LEDs are Class 1A ESD sensitive per JESD22-A114C.01 standard. Please observe appropriate precautions during handling and processing. Refer to Application Note AN-1142 for additional details.

Package Dimensions

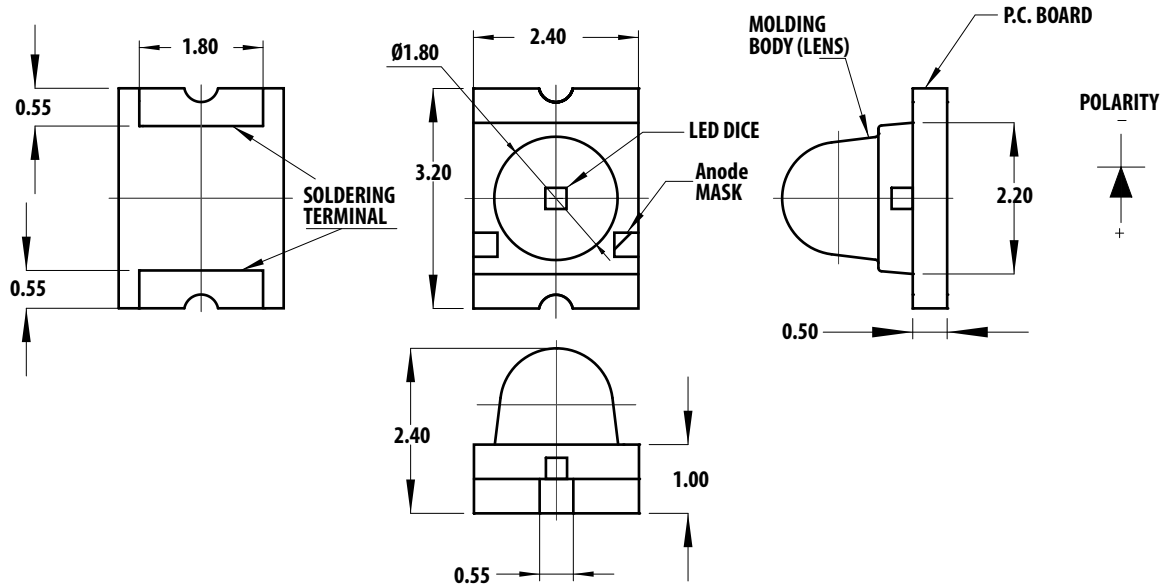

Notes:

1. All dimensions in millimeters.
2. Tolerance is ± 0.1 mm unless otherwise specified.

Device Selection Guide

Color	Part Number	Min. Iv (cd)	Test Current (mA)	Dice Technology
Orange	ASMT-FJ30	5.5	20	AllnGaP

Notes:

1. The luminous intensity Iv is measured at the peak of the spatial radiation pattern which may not be aligned with the mechanical axis of the LED package.
2. Iv Tolerance = $\pm 15\%$

Absolute Maximum Ratings at $T_A = 25^\circ\text{C}$

Parameter	ASMT-FJ30	Units
DC Forward Current	50	mA
Power Dissipation	125	mW
LED Junction Temperature	95	$^\circ\text{C}$
Operating Temperature Range	-40 to 85	$^\circ\text{C}$
Storage Temperature Range	-40 to 85	$^\circ\text{C}$
Soldering Temperature	refer reflow soldering profile (Figure 6)	

Optical Characteristics at $T_A = 25^\circ\text{C}$

Part Number	Color	Peak Wavelength	Dominant Wavelength	Viewing Angle 2
		λ_{peak} (nm)	λ_d [2] (nm)	$\theta_{1/2}$ [4] (Degrees)
		Typ.	Typ.	Typ.
ASMT-FJ30	Orange	612	605	18

Notes:

1. The dominant wavelength, λ_d , is derived from the CIE Chromaticity Diagram and represents the perceived color of the device.
2. $\theta_{1/2}$ is the off-axis angle where the luminous intensity is $\frac{1}{2}$ the peak intensity.

Electrical Characteristics at $T_A = 25^\circ\text{C}$

Color	Test Current	Forward Voltage		Reverse Breakdown,		Thermal Resistance
		V_F (Volts) [1]	Max.	V_R (Volts) @ $I_R = 100\mu\text{A}$	Min.	$R\theta_{J-PIN}$ ($^\circ\text{C}/\text{W}$)
		Typ.				Typ.
Orange	20mA	2.1	2.4	5		300

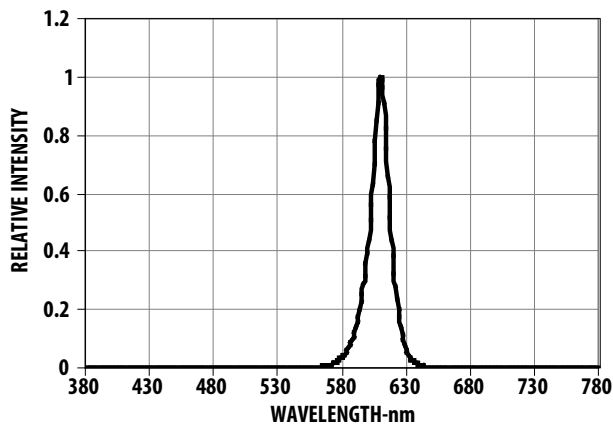

Figure 1. Relative Intensity Vs Wavelength

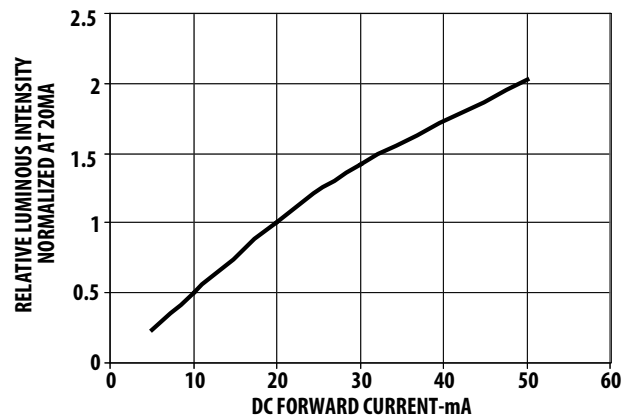

Figure 2. Luminous Intensity vs Forward Current

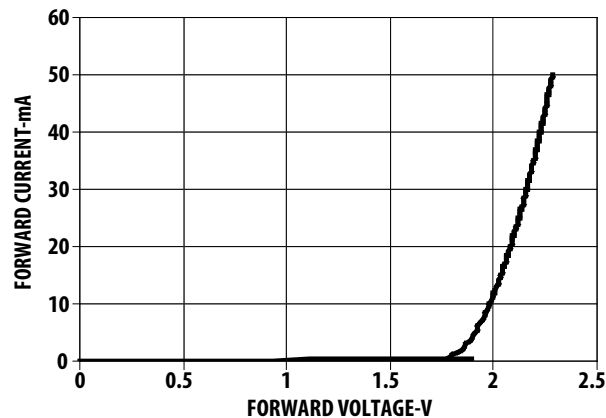

Figure 3. Forward Current vs Forward Voltage

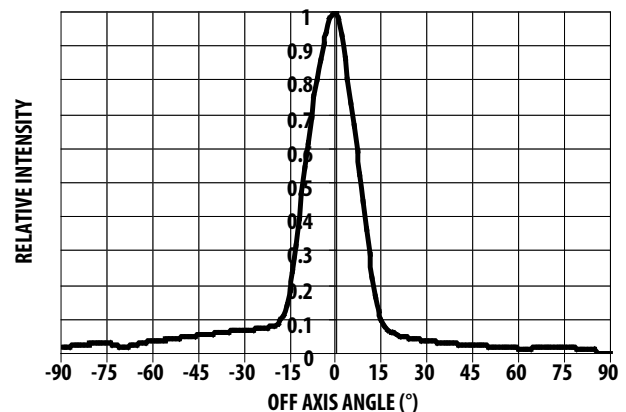

Figure 4. Vertical Radiation Pattern

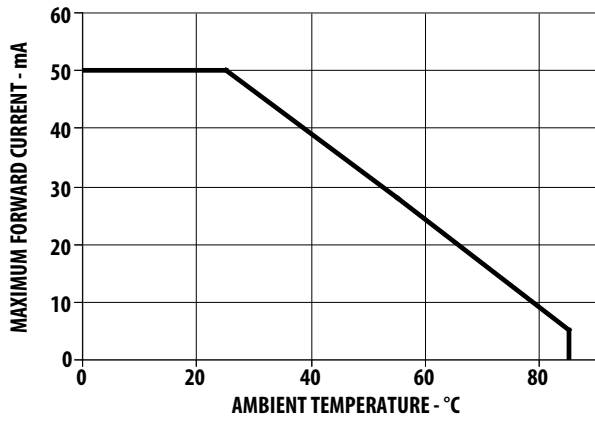

Figure 5. Forward Current vs Forward Voltage

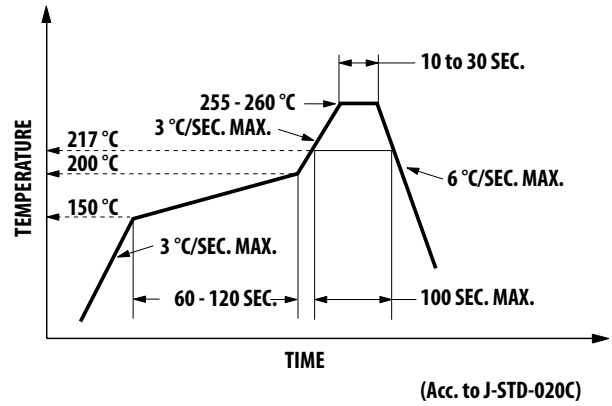

Figure 6. Recommended reflow soldering

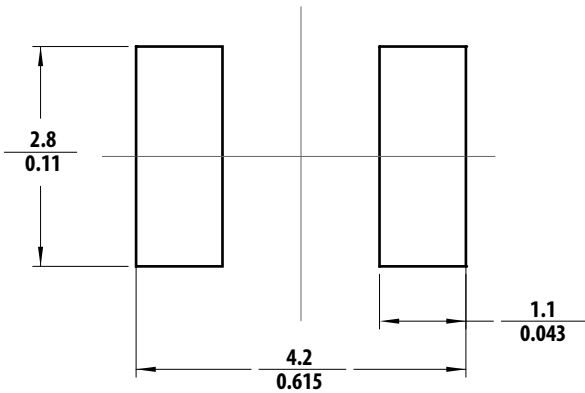

Figure 7. Recommended soldering land pattern

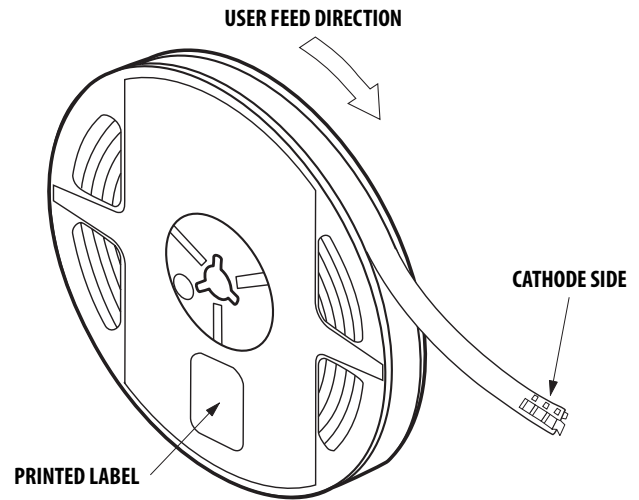
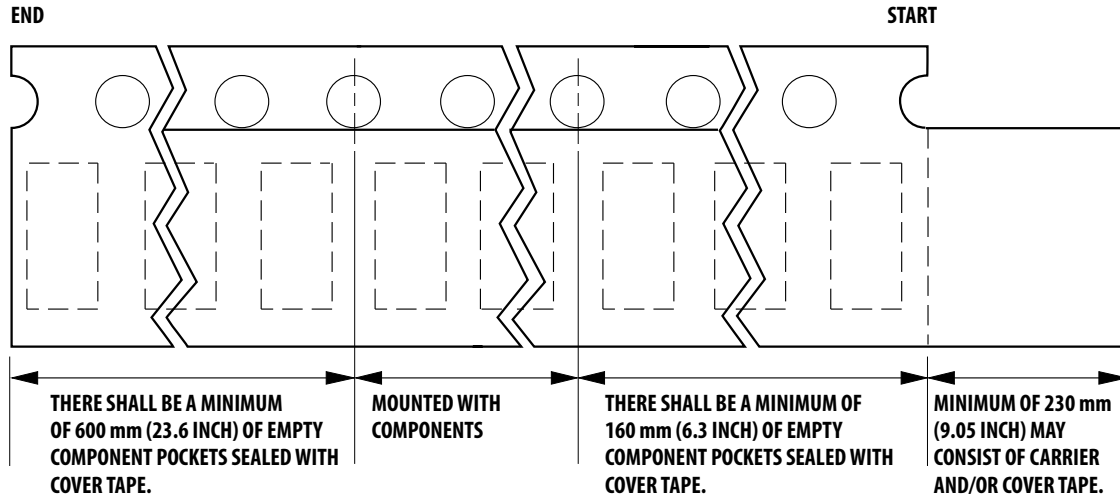

Figure 8. Reeling Orientations



THERE SHALL BE A MINIMUM OF 600 mm (23.6 INCH) OF EMPTY COMPONENT POCKETS SEALED WITH COVER TAPE.

Notes:

1. All dimensions in millimeters (inches).
2. Tolerance is ± 0.1 mm (± 0.004 in.) unless otherwise specified.

Figure 11. Tape leader and trailer dimensions.

Color Bin Category

Orange

Bin ID	Min (nm)	Max (nm)
1	597.0	600.0
2	600.0	603.0
3	603.0	606.0
4	606.0	609.0
5	609.0	612.0

Tolerance = ± 1 nm

Iv Bin Category

Bin ID	Min (cd)	Max(cd)
B	5.5	7.0
C	7.0	9.0
D	9.0	11.5
E	11.5	15.0

Iv Tolerance = $\pm 15\%$

For product information and a complete list of distributors, please go to our web site: www.avagotech.com

Avago, Avago Technologies, and the A logo are trademarks of Avago Technologies, Limited in the United States and other countries. Data subject to change. Copyright © 2007 Avago Technologies Limited. All rights reserved. AV02-0996EN - January 28, 2008

AVAGO
TECHNOLOGIES