



PN2907A

PNP SILICON TRANSISTOR

PNP GENERAL PURPOSE AMPLIFIER

DESCRIPTION

This UTC **PN2907A** is designed for use as a general purpose amplifier and switch requiring collector currents to 500 mA.

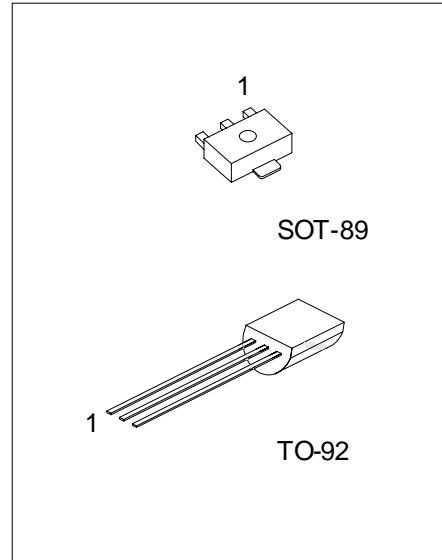

* Pb-free plating product number: PN2907AL

ORDERING INFORMATION

Ordering Number		Package	Pin Assignment			Packing
Normal	Lead Free Plating		1	2	3	
PN2907A-AB3-R	PN2907AL-AB3-R	SOT-89	B	C	E	Tape Reel
PN2907A-T92-B	PN2907AL-T92-B	TO-92	E	B	C	Tape Box
PN2907A-T92-K	PN2907AL-T92-K	TO-92	E	B	C	Bulk

<p>PN2907AL-AB3-R</p> <p>(1) Packing Type</p> <p>(2) Package Type</p> <p>(3) Lead Plating</p>	<p>(1) B: Tape Box, K: Bulk, R: Tape Reel</p> <p>(2) AB3: SOT-89, T92: TO-92</p> <p>(3) L: Lead Free Plating, Blank: Pb/Sn</p>
---	--

■ ABSOLUTE MAXIMUM RATINGS (Ta=25°C, unless otherwise specified.)

PARAMETER		SYMBOL	RATINGS	UNIT
Collector-Emitter Voltage		V _{CEO}	-60	V
Collector-Base Voltage		V _{CBO}	-60	V
Emitter-Base Voltage		V _{EBO}	-5	V
Collector Current-Continuous		I _C	-800	mA
Power Dissipation	SOT-89	P _D	350	mW
	TO-92		625	mW
Junction Temperature		T _J	+150	°C
Storage Temperature		T _{STG}	-40 ~ +150	°C

Note: 1. These are steady state limits. The factory should be consulted on applications involving pulsed or low duty cycle operations.

2. Absolute maximum ratings are those values beyond which the device could be permanently damaged. Absolute maximum ratings are stress ratings only and functional device operation is not implied.

■ THERMAL DATA

PARAMETER		SYMBOL	RATINGS	UNIT
Thermal resistance, junction to Ambient	SOT-89	θ _{JA}	104	/W
	TO-92		200	/W

■ ELECTRICAL CHARACTERISTICS (Ta=25°C, unless otherwise specified.)

PARAMETER	SYMBOL	TEST CONDITIONS	MIN	TYP	MAX	UNIT
OFF CHARACTERISTICS						
Collector-Emitter Breakdown Voltage	BV _{CEO}	I _C =-10mA, I _B =0	-60			V
Collector-Base Breakdown Voltage	BV _{CBO}	I _C =-10μA, I _E =0	-60			V
Emitter-Base Breakdown Voltage	BV _{EBO}	I _E =-10μA, I _C =0	-5			V
Base Cutoff Current	I _B	V _{CB} =-30V, V _{EB} =-0.5V			-50	nA
Collector Cutoff Current	I _{CEX}	V _{CE} =-30V, V _{BE} =-0.5V			-50	nA
Collector Cutoff Current	I _{CBO}	V _{CB} =-50V, I _E =0 V _{CB} =-50V, I _E =0, Ta=150°C			-0.02 -20	μA μA
ON CHARACTERISTICS						
DC Current Gain	h _{FE}	I _C =-0.1mA, V _{CE} =-10V	75			
		I _C =-1.0 mA, V _{CE} =-10V	100			
		I _C =-10 mA, V _{CE} =-10V	100			
		I _C =-150 mA, V _{CE} =-10V (Note)	100		300	
		I _C =-500 mA, V _{CE} =-10V (Note)	50			
Collector-Emitter Saturation Voltage (Note)	V _{CE(SAT)}	I _C =-150mA, I _B =-15mA I _C =-500mA, I _B =-50mA			-0.4 -1.6	V V
Base-Emitter Saturation Voltage	V _{BE(SAT)}	I _C =-150mA, I _B =-15mA (Note) I _C =-500mA, I _B =-50mA			-1.3 -2.6	V V
SMALL SIGNAL CHARACTERISTICS						
Current Gain – Bandwidth Product	f _T	I _C =-50mA, V _{CE} =-20V, f=100MHz	200			MHz
Output Capacitance	C _{ob}	V _{CB} =-10V, I _E =0, f=100kHz			8	pF
Input Capacitance	C _{ib}	V _{EB} =-2V, I _C =0, f=100kHz			30	pF
SWITCHING CHARACTERISTICS						
Turn-on Time	t _{ON}	V _{CC} =-30V, I _C =-150mA I _{B1} =-15mA			45	ns
Delay Time	t _{DLY}				10	ns
Rise Time	t _R				40	ns
Turn-off Time	t _{OFF}	V _{CC} =-6V, I _C =-150mA I _{B1} =I _{B2} =-15mA			100	ns
Storage Time	t _S				80	ns
Fall Time	t _F				30	ns

Note: Pulse Test: Pulse Width ≤ 300ms, Duty Cycle ≤ 2.0%

■ TEST CIRCUITS

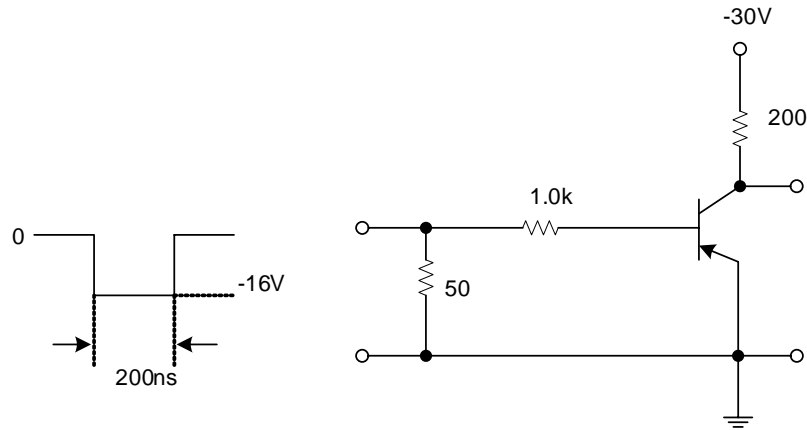

Fig. 1 Saturated Turn-On Switching Time Test Circuit

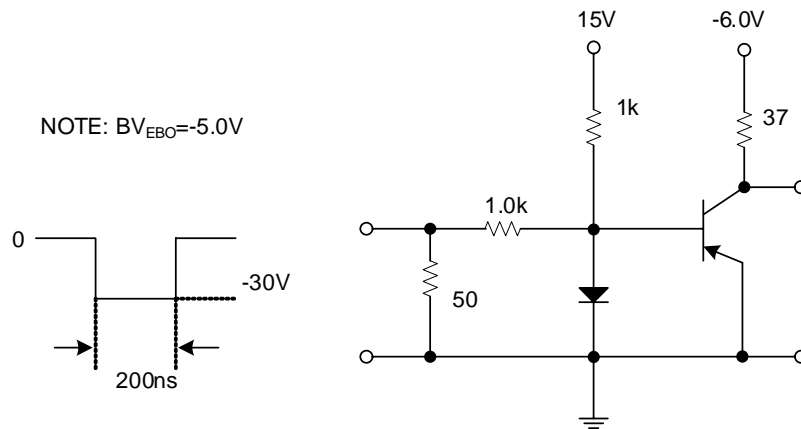
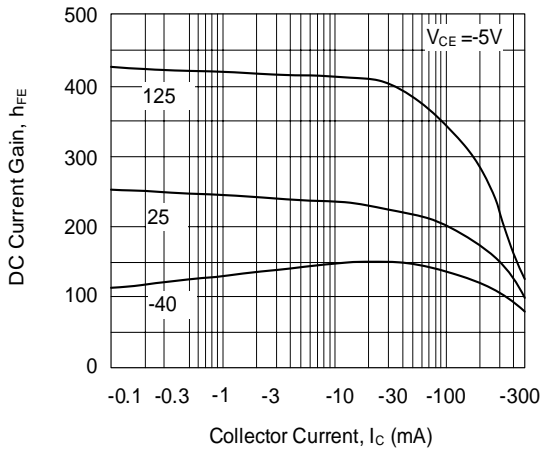

Fig. 2 Saturated Turn-Off Switching Time Test Circuit

TYPICAL CHARACTERISTICS

Typical Pulsed Current Gain vs. Collector Current



Collector-Emitter Saturation Voltage vs. Collector Current

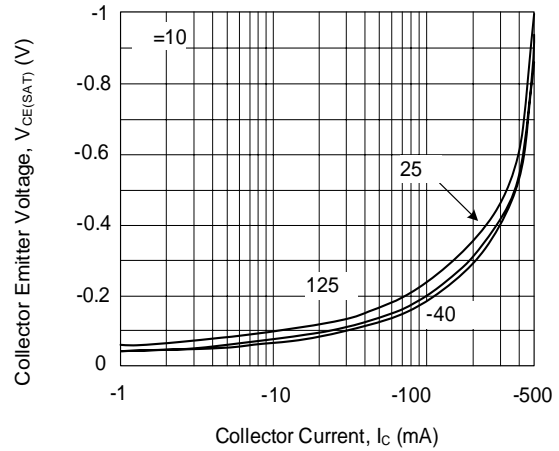

Base-Emitter Saturation Voltage vs. Collector Current

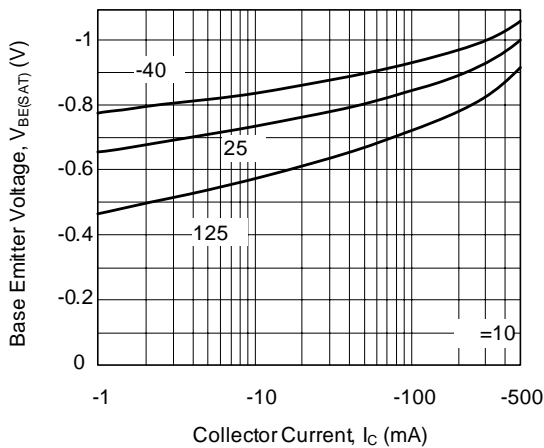

Base-Emitter ON Voltage vs. Collector Current

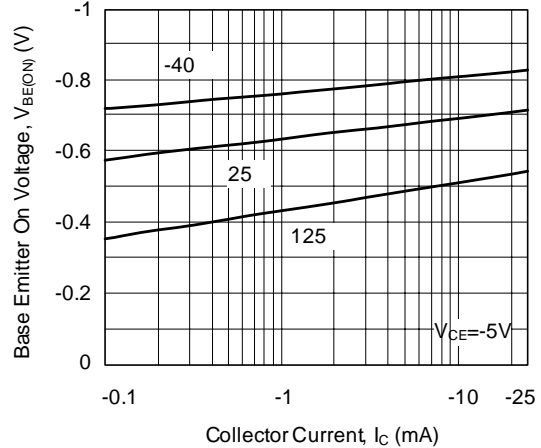

Collector-Cutoff Current vs. Ambient Temperature

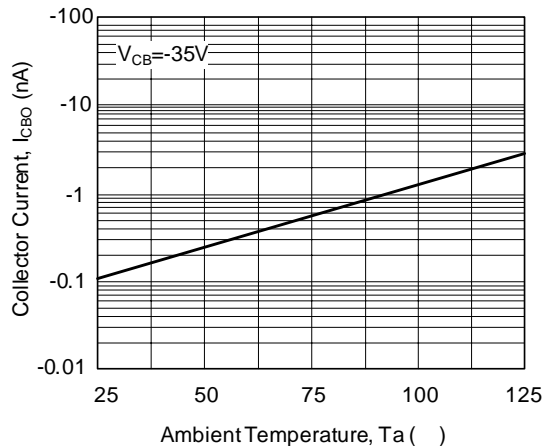

Input and Output Capacitance vs. Reverse Bias Voltage

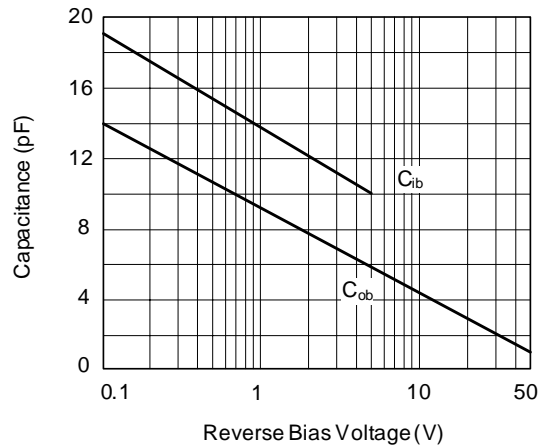

TYPICAL CHARACTERISTICS(Cont.)

Switching Times vs. Collector Current

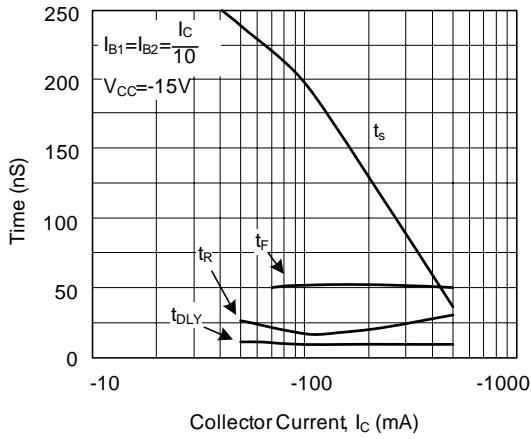

Turn On and Turn Off Times vs. Collector Current

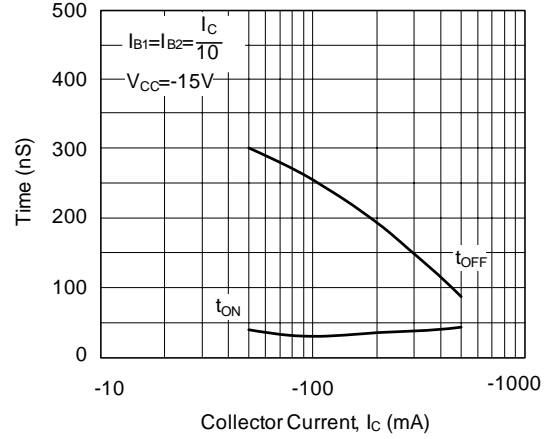

Rise Time vs Collector and Turn On Base Currents

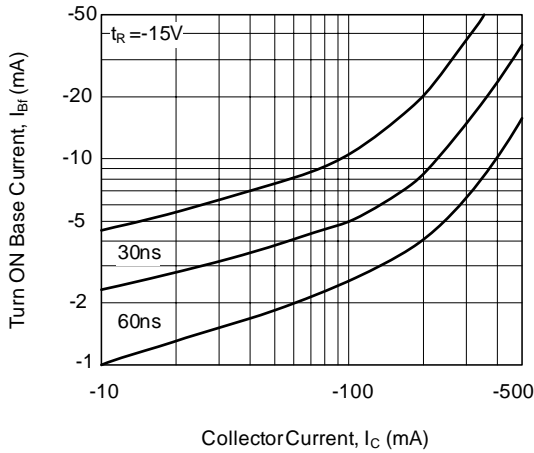

TYPICAL CHARACTERISTICS FOR COMMON EMITTER ($f=1kHz$)

Common Emitter Characteristics

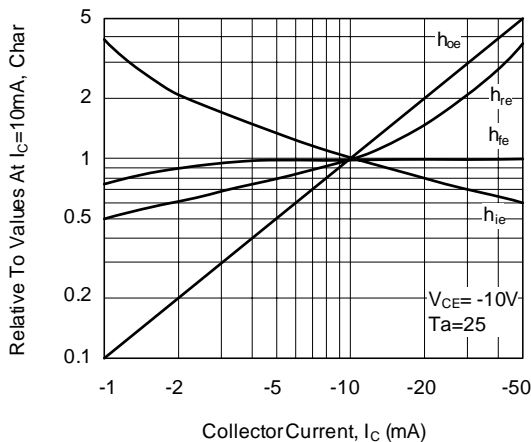

Common Emitter Characteristics

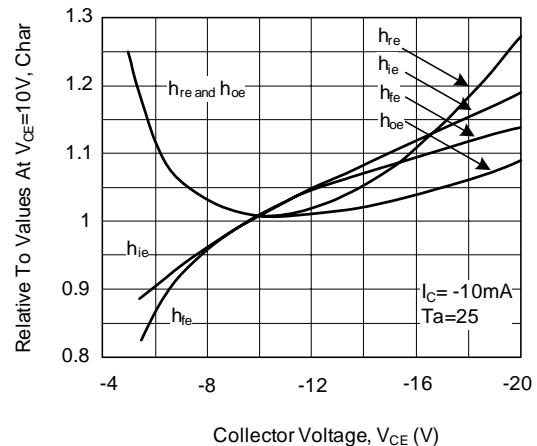

■ TYPICAL CHARACTERISTICS FOR COMMON EMITTER(Cont.)

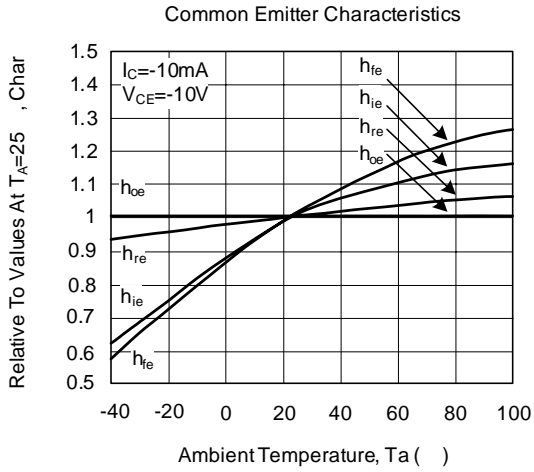

UTC assumes no responsibility for equipment failures that result from using products at values that exceed, even momentarily, rated values (such as maximum ratings, operating condition ranges, or other parameters) listed in products specifications of any and all UTC products described or contained herein. UTC products are not designed for use in life support appliances, devices or systems where malfunction of these products can be reasonably expected to result in personal injury. Reproduction in whole or in part is prohibited without the prior written consent of the copyright owner. The information presented in this document does not form part of any quotation or contract, is believed to be accurate and reliable and may be changed without notice.