

114 dB, 192 kHz 6-Channel D/A Converter

Features

- ◆ 24-bit Conversion
- ◆ Up to 192 kHz Sample Rates
- ◆ 114 dB Dynamic Range
- ◆ -100 dB THD+N
- ◆ Supports PCM or DSD Data Formats
- ◆ Selectable Digital Filters
- ◆ Volume Control with Soft Ramp
 - 1 dB Step Size
 - Zero Crossing Click-free Transitions
- ◆ Dedicated DSD Inputs
- ◆ Low Clock Jitter Sensitivity
- ◆ Simultaneous Support for Two Synchronous Sample Rates for DVD Audio
- ◆ μ C or Stand-Alone Operation

Description

The CS4362 is a complete 6-channel digital-to-analog system including digital interpolation, fifth-order delta-sigma digital-to-analog conversion, digital de-emphasis, volume control and analog filtering. The advantages of this architecture include: ideal differential linearity, no distortion mechanisms due to resistor matching errors, no linearity drift over time and temperature and a high tolerance to clock jitter.

The CS4362 is available in a 48-pin LQFP package in Commercial grade (-10°C to +70°C). The CDB4362 Customer Demonstration Board is also available for device evaluation and implementation suggestions. Please see “[Ordering Information](#)” on page 42 for complete details.

The CS4362 accepts PCM data at sample rates from 4 kHz to 192 kHz, DSD audio data, and operates over a wide power supply range. These features are ideal for multi-channel audio systems including DVD players, SACD players, A/V receivers, digital TV’s, mixing consoles, and effects processors.

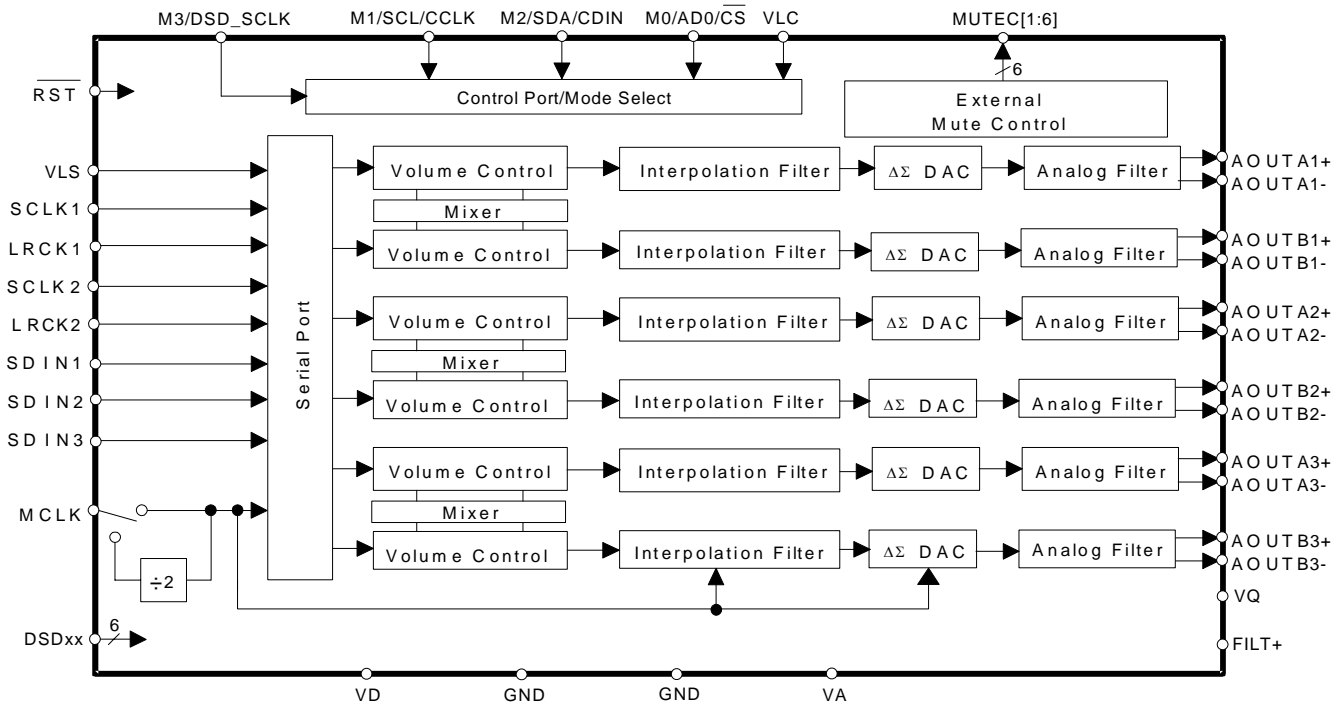

TABLE OF CONTENTS

1. CHARACTERISTICS AND SPECIFICATIONS	5
ANALOG CHARACTERISTICS.....	5
ANALOG CHARACTERISTICS.....	6
POWER AND THERMAL CHARACTERISTICS	6
ANALOG FILTER RESPONSE	7
DIGITAL CHARACTERISTICS.....	8
ABSOLUTE MAXIMUM RATINGS	8
RECOMMENDED OPERATING CONDITIONS	8
SWITCHING CHARACTERISTICS	9
DSD - SWITCHING CHARACTERISTICS	10
SWITCHING CHARACTERISTICS - CONTROL PORT - I ² C [®] FORMAT	11
SWITCHING CHARACTERISTICS - CONTROL PORT - SPI [™] FORMAT.....	12
2. TYPICAL CONNECTION DIAGRAM	13
3. REGISTER QUICK REFERENCE	15
4. REGISTER DESCRIPTION	16
4.1 Mode Control 1 (address 01h)	16
4.1.1 Control Port Enable (CPEN)	16
4.1.2 Freeze Controls (FREEZE)	16
4.1.3 Master Clock Divide Enable (MCLKDIV)	16
4.1.4 DAC Pair Disable (DACx_DIS)	16
4.1.5 Power Down (PDN)	17
4.2 Mode Control 2 (address 02h)	17
4.2.1 Digital Interface Format (DIF)	17
4.2.2 Serial Audio Data Clock Source (SDINXCLK)	18
4.3 Mode Control 3 (address 03h)	18
4.3.1 Soft Ramp and Zero Cross Control (SZC)	18
4.3.2 Single Volume Control (SNGLVOL)	19
4.3.3 Soft Volume Ramp-Up After Error (RMP_UP)	19
4.3.4 MUTE ^C Polarity (MUTE ^C +/-)	19
4.3.5 Auto-Mute (AMUTE)	20
4.3.6 Mute Pin Control (MUTE ^C 1, MUTE ^C 0)	20
4.4 Filter Control (address 04h)	20
4.4.1 Interpolation Filter Select (FILT_SEL)	20
4.4.2 De-Emphasis Control (DEM)	20
4.4.3 Soft Ramp-Down Before Filter Mode Change (RMP_DN)	21
4.5 Invert Control (address 05h)	21
4.5.1 Invert Signal Polarity (Inv_Xx)	21
4.6 Mixing Control Pair 1 (Channels A1 & B1)(address 06h) Mixing Control Pair 2 (Channels A2 & B2)(address 09h) Mixing Control Pair 3 (Channels A3 & B3)(address 0Ch)	21
4.6.1 Channel A Volume = Channel B Volume (A=B)	21
4.6.2 ATAPI Channel Mixing and Muting (ATAPI)	22
4.6.3 Functional Mode (FM)	23
4.7 Volume Control (addresses 07h, 08h, 0Ah, 0Bh, 0Dh, 0Eh)	23
4.7.1 Mute (MUTE)	23
4.7.2 Volume Control (xx_VOL)	23
4.8 Chip Revision (address 12h)	24
4.8.1 Part Number ID (PART) [Read Only]	24
5. PIN DESCRIPTION	25
6. APPLICATIONS	28
6.1 Grounding and Power Supply Decoupling	28

6.2 PCM Mode Select	28
6.3 Recommended Power-Up Sequence	28
6.4 Analog Output and Filtering	28
6.5 Interpolation Filter	28
6.6 Clock Source Selection	29
6.7 Using DSD Mode	29
6.8 Recommended Procedure for Switching Operational Modes	29
7. CONTROL PORT INTERFACE	30
7.1 Enabling the Control Port	30
7.2 Format Selection	30
7.3 I ² C Format	30
7.3.1 Writing in I ² C Format	30
7.3.2 Reading in I ² C Format	30
7.4 SPI Format	31
7.4.1 Writing in SPI	31
7.5 Memory Address Pointer (MAP)	32
7.5.1 INCR (Auto Map Increment Enable)	32
7.5.2 MAP4-0 (Memory Address Pointer)	32
8. FILTER PLOTS	33
9. DIAGRAMS	37
10. PARAMETER DEFINITIONS	40
11. REFERENCES	40
12. PACKAGE DIMENSIONS	41
13. ORDERING INFORMATION	42
14. REVISION HISTORY	42

LIST OF FIGURES

Figure 1. Serial Mode Input Timing	9
Figure 2. Direct Stream Digital - Serial Audio Input Timing.....	10
Figure 3. Control Port Timing - I ² C Format.....	11
Figure 4. Control Port Timing - SPI Format.....	12
Figure 5. Typical Connection Diagram Control Port.....	13
Figure 6. Typical Connection Diagram Stand-Alone	14
Figure 7. Control Port Timing, I ² C Format.....	31
Figure 8. Control Port Timing, SPI Format.....	31
Figure 9. Single-Speed (fast) Stopband Rejection.....	33
Figure 10. Single-Speed (fast) Transition Band.....	33
Figure 11. Single-Speed (fast) Transition Band (detail).....	33
Figure 12. Single-Speed (fast) Passband Ripple.....	33
Figure 13. Single-Speed (slow) Stopband Rejection	33
Figure 14. Single-Speed (slow) Transition Band.....	33
Figure 15. Single-Speed (slow) Transition Band (detail).....	34
Figure 16. Single-Speed (slow) Passband Ripple.....	34
Figure 17. Double-Speed (fast) Stopband Rejection	34
Figure 18. Double-Speed (fast) Transition Band.....	34
Figure 19. Double-Speed (fast) Transition Band (detail).....	34
Figure 20. Double-Speed (fast) Passband Ripple.....	34
Figure 21. Double-Speed (slow) Stopband Rejection	35
Figure 22. Double-Speed (slow) Transition Band	35
Figure 23. Double-Speed (slow) Transition Band (detail)	35
Figure 24. Double-Speed (slow) Passband Ripple	35
Figure 25. Quad-Speed (fast) Stopband Rejection	35
Figure 26. Quad-Speed (fast) Transition Band	35

Figure 27. Quad-Speed (fast) Transition Band	36
Figure 28. Quad-Speed (fast) Passband Ripple	36
Figure 29. Quad-Speed (slow) Stopband Rejection.....	36
Figure 30. Quad-Speed (slow) Transition Band.....	36
Figure 31. Quad-Speed (slow) Transition Band (detail).....	36
Figure 32. Quad-Speed (slow) Passband Ripple.....	36
Figure 33. Format 0 - Left Justified up to 24-bit Data.....	37
Figure 34. Format 1 - I ² S up to 24-bit Data	37
Figure 35. Format 2 - Right Justified 16-bit Data	37
Figure 36. Format 3 - Right Justified 24-bit Data	37
Figure 37. Format 4 - Right Justified 20-bit Data	38
Figure 38. Format 5 - Right Justified 18-bit Data	38
Figure 39. De-Emphasis Curve.....	38
Figure 40. Channel Pair Routing Diagram (x = Channel Pair 1, 2, or 3).....	39
Figure 41. ATAPI Block Diagram (x = channel pair 1, 2, or 3).....	39
Figure 42. Recommended Output Filter.....	39

LIST OF TABLES

Table 1. Digital Interface Formats - PCM Mode.....	17
Table 2. Digital Interface Formats - DSD Mode	18
Table 3. ATAPI Decode	22
Table 4. Example Digital Volume Settings	23
Table 5. Common Clock Frequencies.....	27
Table 6. Digital Interface Format, Stand-Alone Mode Options.....	27
Table 7. Mode Selection, Stand-Alone Mode Options	27
Table 8. Direct Stream Digital (DSD), Stand-Alone Mode Options	27

1. CHARACTERISTICS AND SPECIFICATIONS

ANALOG CHARACTERISTICS

(Full-Scale Output Sine Wave, 997 Hz; Measurement Bandwidth 10 Hz to 20 kHz, unless otherwise specified; Test load $R_L = 3\text{ k}\Omega$, $C_L = 100\text{ pF}$, $V_A = 5\text{ V}$, $V_D = 3.3\text{ V}$ (see [Figure 5](#)))

For Single-Speed Mode, $F_s = 48\text{ kHz}$, $SCLK = 3.072\text{ MHz}$, $MCLK = 12.288\text{ MHz}$;

For Double-Speed Mode, $F_s = 96\text{ kHz}$, $SCLK = 6.144\text{ MHz}$, $MCLK = 12.288\text{ MHz}$;

For Quad-Speed Mode, $F_s = 192\text{ kHz}$, $SCLK = 12.288\text{ MHz}$, $MCLK = 24.576\text{ MHz}$;

For Direct Stream Digital Mode, $F_s = 128 \times 48\text{ kHz}$, $DSD_SCLK = 6.144\text{ MHz}$, $MCLK = 12.288\text{ MHz}$).

Parameters	Symbol	Min	Typ	Max	Unit		
CS4362-KQZ Dynamic Performance - All PCM modes and DSD (Note 1)							
Specified Temperature Range	T_A	-10	-	70	°C		
Dynamic Range (Note 2)	24-bit unweighted	105	111	-	dB		
	A-Weighted	108	114	-	dB		
	16-bit unweighted	-	94	-	dB		
	(Note 3) A-Weighted	-	97	-	dB		
Total Harmonic Distortion + Noise	24-bit	(Note 2) 0 dB	THD+N	-	-100	-94	dB
		-20 dB	-	-91	-	dB	
		-60 dB	-	-51	-	dB	
	16-bit	0 dB	-	-94	-	dB	
		(Note 3) -20 dB	-	-74	-	dB	
		-60 dB	-	-34	-	dB	
Idle Channel Noise / Signal-to-noise ratio		-	114	-	dB		
Interchannel Isolation	(1 kHz)	-	90	-	dB		

Notes:

1. CS4362-KQZ parts are tested at 25°C.
2. One-half LSB of triangular PDF dither is added to data.
3. Performance limited by 16-bit quantization noise.

ANALOG CHARACTERISTICS

(Continued)

Parameters	Symbol	Min	Typ	Max	Units
Analog Output - All PCM modes and DSD					
Full Scale Differential Output Voltage (Note 4)	V_{FS}	86% V_A	91% V_A	96% V_A	Vpp
Quiescent Voltage	V_Q	-	50% V_A	-	VDC
Max Current from V_Q	I_{QMAX}	-	1	-	μA
Interchannel Gain Mismatch		-	0.1	-	dB
Gain Drift		-	100	-	ppm/ $^{\circ}C$
Output Impedance (Note 4)	Z_{OUT}	-	100	-	Ω
AC-Load Resistance	R_L	3	-	-	k Ω
Load Capacitance	C_L	-	-	100	pF

POWER AND THERMAL CHARACTERISTICS

Parameters	Symbol	Min	Typ	Max	Units
Power Supplies					
Power Supply Current (Note 5) normal operation, $V_A=5V$ $V_D=5V$ $V_D=3.3V$ Interface current, $V_{LC}=5V$ (Notes 6, 7) $V_{LS}=5V$ power-down state (all supplies) (Note 8)	I_A	-	50	55	mA
	I_D	-	38	60	mA
	I_D	-	25	40	mA
	I_{LC}	-	2	-	μA
	I_{LS}	-	84	-	μA
	I_{pd}	-	200	-	μA
Power Dissipation (Note 5) $V_A=5V$, $V_D=3.3V$ normal operation power-down (Note 8) $V_A=5V$, $V_D=5V$ normal operation power-down (Note 8)		-	335	410	mW
		-	1	-	mW
		-	440	575	mW
		-	1	-	mW
Package Thermal Resistance multi-layer dual-layer	θ_{JA}	-	48	-	$^{\circ}C/Watt$
	θ_{JA}	-	65	-	$^{\circ}C/Watt$
	θ_{JC}	-	15	-	$^{\circ}C/Watt$
Power Supply Rejection Ratio (Note 9) (1 kHz) (60 Hz)	PSRR	-	60	-	dB
		-	40	-	dB

Notes:

- V_{FS} is tested under load R_L and includes attenuation due to Z_{OUT}
- Current consumption increases with increasing FS within a given speed mode and is signal dependant. Max values are based on highest FS and highest MCLK.
- I_{LC} measured with no external loading on the SDA pin.
- This specification is violated when the VLC supply is greater than VD and when pin 16 (M1/SDA) is tied or pulled low. Logic tied to pin 16 needs to be able to sink this current.
- Power Down Mode is defined as \overline{RST} pin = Low with all clock and data lines held static.
- Valid with the recommended capacitor values on FILT+ and VQ as shown in Figures 5 and 6.

ANALOG FILTER RESPONSE

Parameter	Fast Roll-Off			Slow Roll-Off (Note 10)			Unit	
	Min	Typ	Max	Min	Typ	Max		
Combined Digital and On-chip Analog Filter Response - Single-Speed Mode (Note 11)								
Passband (Note 12)	to -0.01 dB corner	0	-	.454	0	-	0.417	Fs
	to -3 dB corner	0	-	.499	0	-	0.499	Fs
Frequency Response 10 Hz to 20 kHz	-0.01	-	+0.01	-0.01	-	+0.01		dB
StopBand	.547	-	-	.583	-	-		Fs
StopBand Attenuation (Note 13)	90	-	-	64	-	-		dB
Group Delay	-	12/Fs	-	-	6.5/Fs	-		s
Passband Group Delay Deviation 0 - 20 kHz	-	-	±0.41/Fs	-	-	±0.14/Fs		s
De-emphasis Error (Note 14) (Relative to 1 kHz)	Fs = 32 kHz	-	-	±0.23	-	-	±0.23	dB
	Fs = 44.1 kHz	-	-	±0.14	-	-	±0.14	dB
	Fs = 48 kHz	-	-	±0.09	-	-	±0.09	dB
Combined Digital and On-chip Analog Filter Response - Double-Speed Mode - 96 kHz (Note 11)								
Passband (Note 12)	to -0.01 dB corner	0	-	.430	0	-	.296	Fs
	to -3 dB corner	0	-	.499	0	-	.499	Fs
Frequency Response 10 Hz to 20 kHz	-0.01	-	0.01	-0.01	-	0.01		dB
StopBand	.583	-	-	.792	-	-		Fs
StopBand Attenuation (Note 13)	80	-	-	70	-	-		dB
Group Delay	-	4.6/Fs	-	-	3.9/Fs	-		s
Passband Group Delay Deviation 0 - 20 kHz	-	-	±0.03/Fs	-	-	±0.01/Fs		s
Combined Digital and On-chip Analog Filter Response - Quad-Speed Mode - 192 kHz (Note 11)								
Passband (Note 12)	to -0.01 dB corner	0	-	.105	0	-	.104	Fs
	to -3 dB corner	0	-	.490	0	-	.481	Fs
Frequency Response 10 Hz to 20 kHz	-0.01	-	0.01	-0.01	-	0.01		dB
StopBand	.635	-	-	.868	-	-		Fs
StopBand Attenuation (Note 13)	90	-	-	75	-	-		dB
Group Delay	-	4.7/Fs	-	-	4.2/Fs	-		s
Passband Group Delay Deviation 0 - 20 kHz	-	-	±0.01/Fs	-	-	±0.01/Fs		s
Combined Digital and On-chip Analog Filter Response - DSD Mode (Note 11)								
Passband (Note 12)	to -0.1 dB corner	-	-	-	0	-	20	kHz
	to -3 dB corner	-	-	-	0	-	120	kHz
Frequency Response 10 Hz to 20 kHz	-	-	-	-0.01	-	0.1		dB

Notes:

10. Slow Roll-Off interpolation filter is only available in Control Port Mode.
11. Filter response is not tested but is guaranteed by design.
12. Response is clock dependent and will scale with Fs. Note that the response plots (Figures 9 to 32) have been normalized to Fs and can be de-normalized by multiplying the X-axis scale by Fs.
13. Single- and Double-Speed Mode Measurement Bandwidth is from stopband to 3 Fs.
Quad-Speed Mode Measurement Bandwidth is from stopband to 1.34 Fs.
14. De-emphasis is available only in Single-Speed Mode; Only 44.1 kHz De-emphasis is available in Stand-Alone Mode.

DIGITAL CHARACTERISTICS

(For KQZ $T_A = -10^{\circ}\text{C}$ to $+70^{\circ}\text{C}$; VLC = VLS = 1.8 V to 5.5 V)

Parameters	Symbol	Min	Typ	Max	Units
High-Level Input Voltage	Serial Data Port	V_{IH}	70% VLS	-	V
	Control Port	V_{IH}	70% VLC	-	V
Low-Level Input Voltage	Serial Data Port	V_{IL}	-	20% VLS	V
	Control Port	V_{IL}	-	20% VLC	V
Input Leakage Current	(Note 7)	I_{in}	-	± 10	μA
Input Capacitance			8	-	pF
Maximum MUTE C Drive Current			3	-	mA
MUTE C High-Level Output Voltage		V_{OH}	VA	-	V
MUTE C Low-Level Output Voltage		V_{OL}	0	-	V

ABSOLUTE MAXIMUM RATINGS

(GND = 0 V; all voltages with respect to ground.)

Parameters	Symbol	Min	Max	Units	
DC Power Supply	Analog power	VA	-0.3	6.0	V
	Digital internal power	VD	-0.3	6.0	V
	Serial data port interface power	VLS	-0.3	6.0	V
	Control port interface power	VLC	-0.3	6.0	V
Input Current, Any Pin Except Supplies	I_{in}	-	± 10	mA	
Digital Input Voltage	Serial data port interface	V_{IND-S}	-0.3	VLS+ 0.4	V
	Control port interface	V_{IND-C}	-0.3	VLC+ 0.4	V
Ambient Operating Temperature (power applied)	T_A	-55	125	$^{\circ}\text{C}$	
Storage Temperature	T_{stg}	-65	150	$^{\circ}\text{C}$	

WARNING: Operation at or beyond these limits may result in permanent damage to the device. Normal operation is not guaranteed at these extremes.

RECOMMENDED OPERATING CONDITIONS

(GND = 0 V; all voltages with respect to ground.)

Parameters	Symbol	Min	Typ	Max	Units	
DC Power Supply	Analog power	VA	4.5	5.0	5.5	V
	Digital internal power	VD	3.0	3.3	5.5	V
	Serial data port interface power	VLS	1.8	5.0	5.5	V
	Control port interface power	VLC	1.8	5.0	5.5	V

SWITCHING CHARACTERISTICS

(For KQZ $T_A = -10^{\circ}\text{C}$ to $+70^{\circ}\text{C}$; VLS = 1.8 V to 5.5 V; Inputs: Logic 0 = GND, Logic 1 = VLS, $C_L = 30$ pF)

Parameters	Symbol	Min	Typ	Max	Units
MCLK Frequency (Note 15)					
Single-Speed Mode		1.024	-	51.2	MHz
Double-Speed Mode		6.400	-	51.2	MHz
Quad-Speed Mode		6.400	-	51.2	MHz
MCLK Duty Cycle		40	50	60	%
Input Sample Rate					
Single-Speed Mode	F_s	4	-	50	kHz
Double-Speed Mode	F_s	50	-	100	kHz
Quad-Speed Mode	F_s	100	-	200	kHz
LRCK Duty Cycle		45	50	55	%
SCLK Pulse Width Low	t_{sclkl}	20	-	-	ns
SCLK Pulse Width High	t_{sclkh}	20	-	-	ns
SCLK Period	t_{sclkw}	$\frac{2}{MCLK}$	-	-	ns
	(Note 16) t_{sclkw}	$\frac{4}{MCLK}$	-	-	ns
SCLK rising to LRCK edge delay	t_{slrd}	20	-	-	ns
SCLK rising to LRCK edge setup time	t_{slrs}	20	-	-	ns
SDATA valid to SCLK rising setup time	t_{sdhrs}	20	-	-	ns
SCLK rising to SDATA hold time	t_{sdh}	20	-	-	ns
LRCK1 to LRCK2 frequency ratio (Note 17)		0.25	1.00	4.00	

Notes:

15. See Table 5 on page 27 for suggested MCLK frequencies
16. This serial clock is available only in Control Port Mode when the MCLK Divide bit is enabled.
17. The higher frequency LRCK must be an exact integer multiple (1, 2, or 4) of the lower frequency LRCK

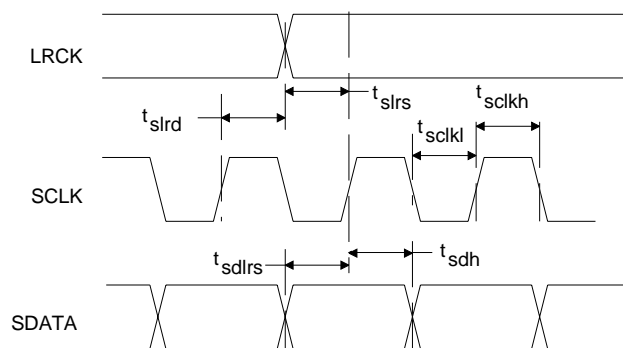

Figure 1. Serial Mode Input Timing

DSD - SWITCHING CHARACTERISTICS

($T_A = -10^\circ\text{C}$ to 70°C ; Logic 0 = GND; VLS = 1.8 V to 5.5 V; Logic 1 = VLS Volts; $C_L = 30$ pF)

Parameter	Symbol	Min	Typ	Max	Unit
Master Clock Frequency (Note 18)		4.096	-	38.4	MHz
MCLK Duty Cycle (All DSD modes)		40	50	60	%
DSD_SCLK Pulse Width Low	t_{sckl}	20	-	-	ns
DSD_SCLK Pulse Width High	t_{sckh}	20	-	-	ns
DSD_SCLK Frequency (64x Oversampled)		1.024	-	3.2	MHz
(128x Oversampled)		2.048	-	6.4	MHz
DSD_L / _R valid to DSD_SCLK rising setup time	t_{sdhrs}	20	-	-	ns
DSD_SCLK rising to DSD_L or DSD_R hold time	t_{sdh}	20	-	-	ns

Note:

18. Min is 4 times 64x DSD or 2 times 128x DSD, and Max is 12 times 64x DSD or 6 times 128x DSD. The proper MCLK to DSD_SCLK ratio must be set either by the DIF registers or the M0:2 pins

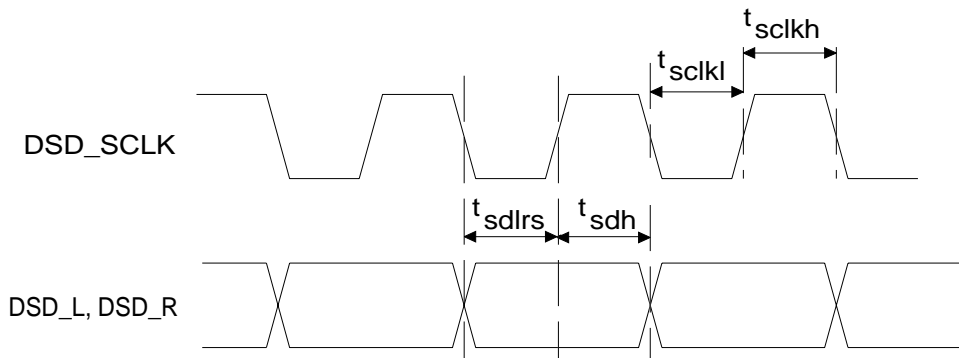

Figure 2. Direct Stream Digital - Serial Audio Input Timing

SWITCHING CHARACTERISTICS - CONTROL PORT - I²C[®] FORMAT

(For KQZ T_A = -10°C to +70°C; VLC = 1.8 V to 5.5 V; Inputs: Logic 0 = GND, Logic 1 = VLC, C_L = 30 pF)

Parameter	Symbol	Min	Max	Unit
SCL Clock Frequency	f _{scl}	-	100	kHz
RST Rising Edge to Start	t _{irs}	500	-	ns
Bus Free Time Between Transmissions	t _{buf}	4.7	-	μs
Start Condition Hold Time (prior to first clock pulse)	t _{hdst}	4.0	-	μs
Clock Low time	t _{low}	4.7	-	μs
Clock High Time	t _{high}	4.0	-	μs
Setup Time for Repeated Start Condition	t _{sust}	4.7	-	μs
SDA Hold Time from SCL Falling (Note 19)	t _{hdd}	0	-	μs
SDA Setup time to SCL Rising	t _{sud}	250	-	ns
Rise Time of SCL and SDA	t _{rc} , t _{rc}	-	1	μs
Fall Time SCL and SDA	t _{fc} , t _{fc}	-	300	ns
Setup Time for Stop Condition	t _{susp}	4.7	-	μs
Acknowledge Delay from SCL Falling (Note 20)	t _{ack}	-	(Note 21)	ns

Notes:

19. Data must be held for sufficient time to bridge the transition time, t_{fc}, of SCL.
20. The acknowledge delay is based on MCLK and can limit the maximum transaction speed.
21. $\frac{15}{256 \times F_s}$ for Single-Speed Mode, $\frac{15}{128 \times F_s}$ for Double-Speed Mode, $\frac{15}{64 \times F_s}$ for Quad-Speed Mode.

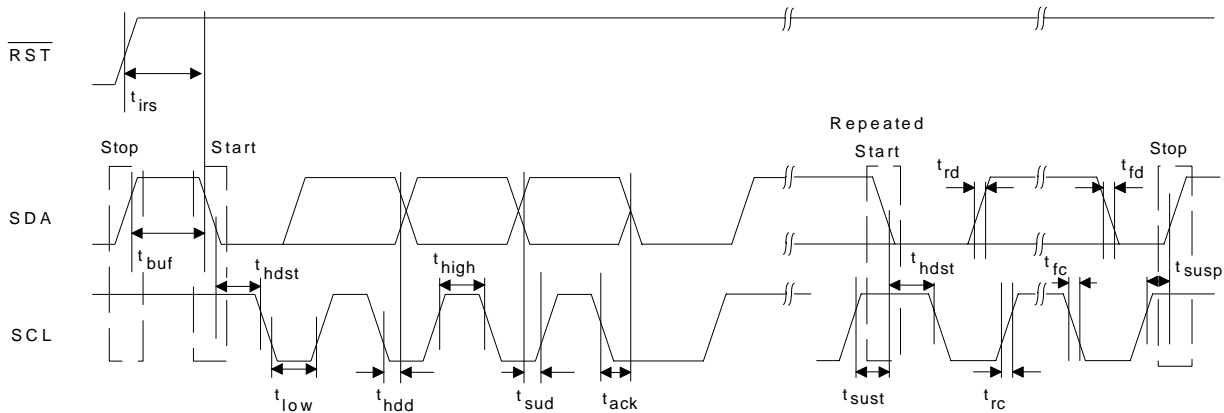

Figure 3. Control Port Timing - I²C Format

SWITCHING CHARACTERISTICS - CONTROL PORT - SPI™ FORMAT

(For KQZ $T_A = -10^\circ\text{C}$ to $+70^\circ\text{C}$; VLC = 1.8 V to 5.5 V; Inputs: Logic 0 = GND, Logic 1 = VLC, $C_L = 30$ pF)

Parameter	Symbol	Min	Max	Unit
CCLK Clock Frequency	f_{sclk}	-	$\frac{MCLK}{2}$	MHz
RST Rising Edge to CS Falling	t_{srs}	500	-	ns
CCLK Edge to $\overline{\text{CS}}$ Falling (Note 22)	t_{spi}	500	-	ns
$\overline{\text{CS}}$ High Time Between Transmissions	t_{csh}	1.0	-	μs
$\overline{\text{CS}}$ Falling to CCLK Edge	t_{css}	20	-	ns
CCLK Low Time	t_{scl}	$\frac{1}{MCLK}$	-	ns
CCLK High Time	t_{sch}	$\frac{1}{MCLK}$	-	ns
CDIN to CCLK Rising Setup Time	t_{dsu}	40	-	ns
CCLK Rising to DATA Hold Time (Note 23)	t_{dh}	15	-	ns
Rise Time of CCLK and CDIN (Note 24)	t_{r2}	-	100	ns
Fall Time of CCLK and CDIN (Note 24)	t_{f2}	-	100	ns

Notes:

22. t_{spi} only needed before first falling edge of $\overline{\text{CS}}$ after $\overline{\text{RST}}$ rising edge. $t_{\text{spi}} = 0$ at all other times.
23. Data must be held for sufficient time to bridge the transition time of CCLK.
24. For $F_{\text{SCK}} < 1$ MHz.

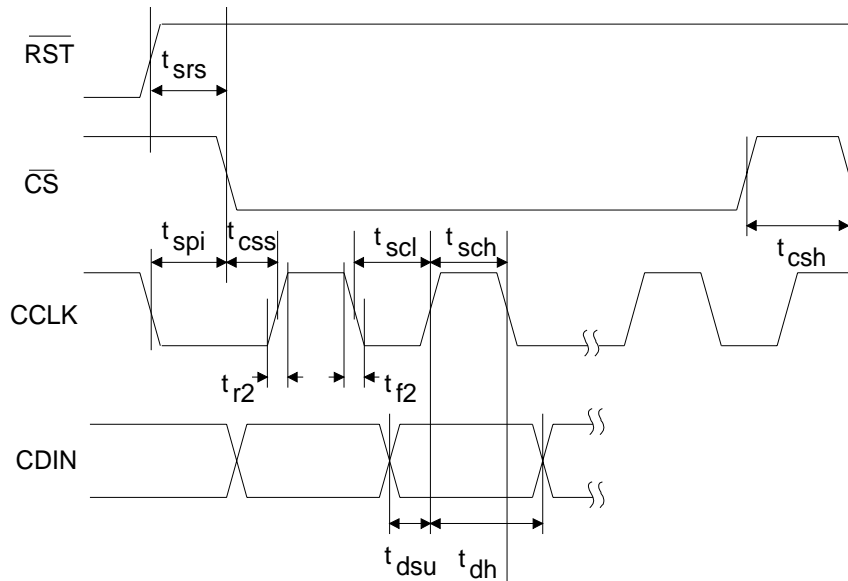

Figure 4. Control Port Timing - SPI Format

2. TYPICAL CONNECTION DIAGRAM

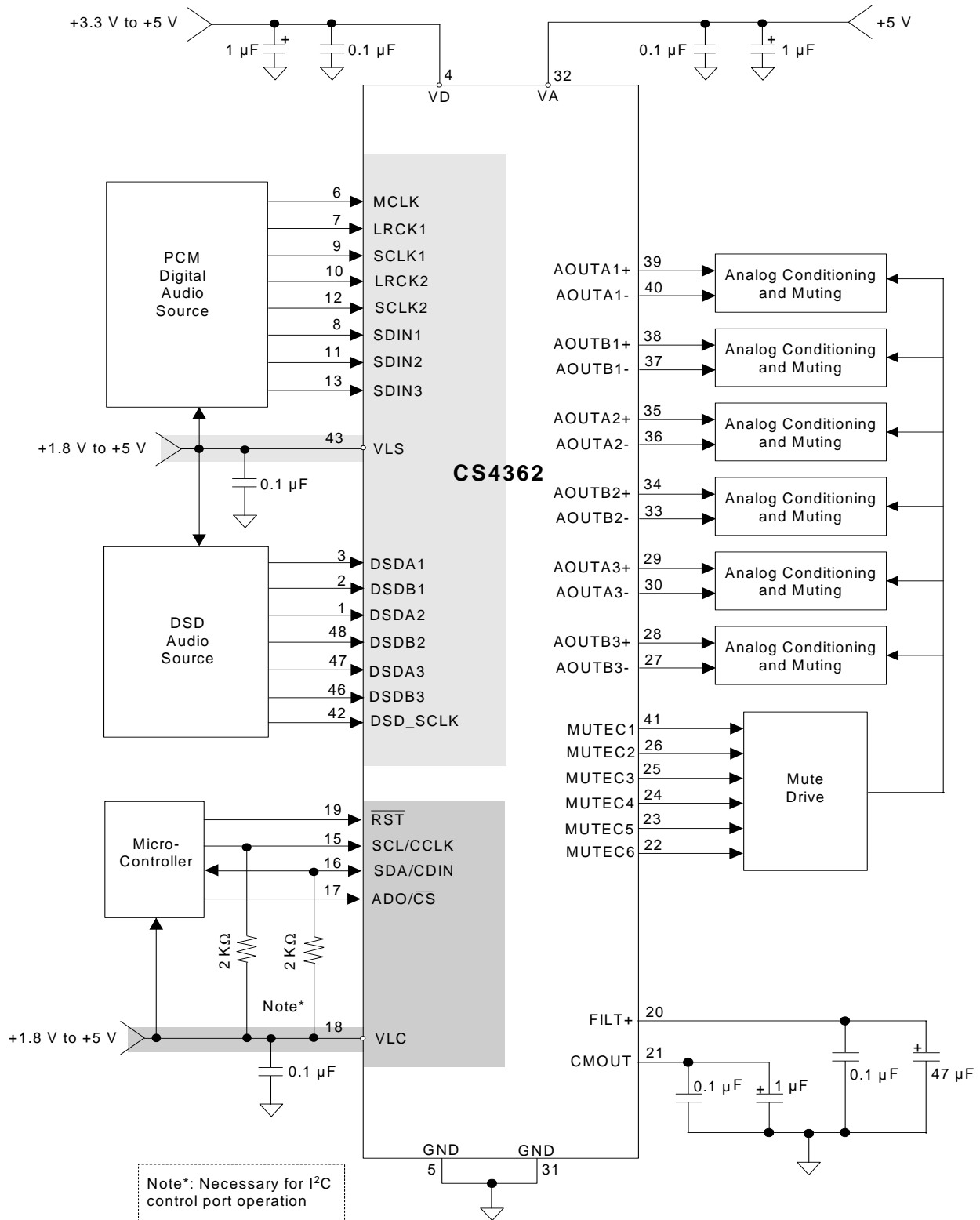
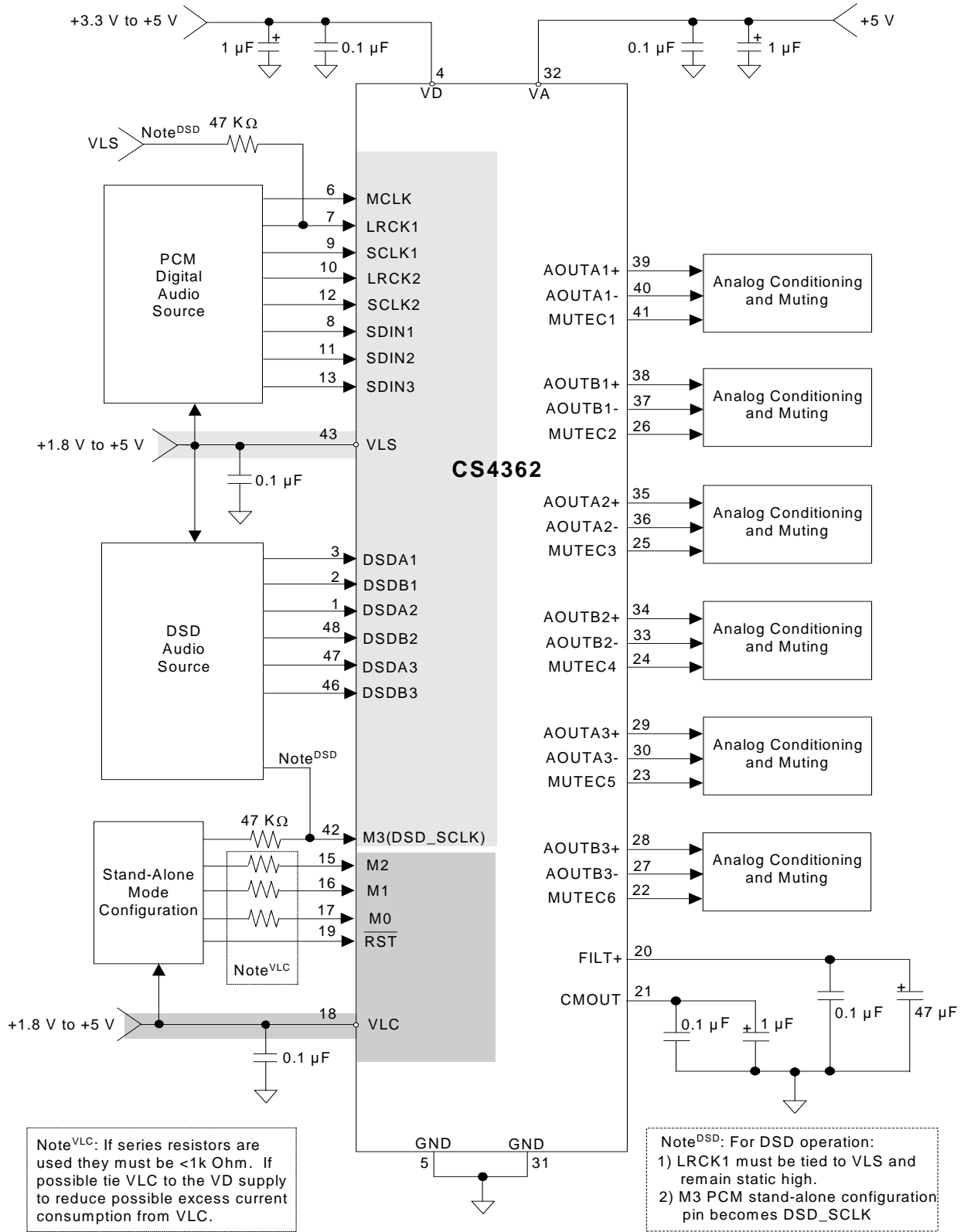

Figure 5. Typical Connection Diagram Control Port

Figure 6. Typical Connection Diagram Stand-Alone

3. REGISTER QUICK REFERENCE

Addr	Function	7	6	5	4	3	2	1	0
01h	Mode Control 1 default	CPEN 0	FREEZE 0	MCLKDIV 0	Reserved 0	DAC3_DIS 0	DAC2_DIS 0	DAC1_DIS 0	PDN 1
02h	Mode Control 2 default	Reserved 0	DIF2 0	DIF1 0	DIF0 0	Reserved 0	SDIN3CLK 0	SDIN2CLK 0	SDIN1CLK 0
03h	Mode Control 3 default	SZC1 1	SZC0 0	SNGLVOL 0	RMP_UP 0	MUTE ^{+/-} 0	AMUTE 1	MUTE ^{C1} 0	MUTE ^{C0} 0
04h	Filter Control default	Reserved 0	Reserved 0	Reserved 0	FILT_SEL 0	Reserved 0	DEM1 0	DEM0 0	RMP_DN 0
05h	Invert Control default	Reserved 0	Reserved 0	INV_B3 0	INV_A3 0	INV_B2 0	INV_A2 0	INV_B1 0	INV_A1 0
06h	Mixing Control Pair 1 (AOUTx1) default	P1_A=B 0	P1ATAPI4 0	P1ATAPI3 1	P1ATAPI2 0	P1ATAPI1 0	P1ATAPI0 1	P1FM1 0	P1FM0 0
07h	Vol. Control A1 default	A1_MUTE 0	A1_VOL6 0	A1_VOL5 0	A1_VOL4 0	A1_VOL3 0	A1_VOL2 0	A1_VOL1 0	A1_VOL0 0
08h	Vol. Control B1 default	B1_MUTE 0	B1_VOL6 0	B1_VOL5 0	B1_VOL4 0	B1_VOL3 0	B1_VOL2 0	B1_VOL1 0	B1_VOL0 0
09h	Mixing Control Pair 2 (AOUTx2) default	P2_A=B 0	P2ATAPI4 0	P2ATAPI3 1	P2ATAPI2 0	P2ATAPI1 0	P2ATAPI0 1	P2FM1 0	P2FM0 0
0Ah	Vol. Control A2 default	A2_MUTE 0	A2_VOL6 0	A2_VOL5 0	A2_VOL4 0	A2_VOL3 0	A2_VOL2 0	A2_VOL1 0	A2_VOL0 0
0Bh	Vol. Control B2 default	B2_MUTE 0	B2_VOL6 0	B2_VOL5 0	B2_VOL4 0	B2_VOL3 0	B2_VOL2 0	B2_VOL1 0	B2_VOL0 0
0Ch	Mixing Control Pair 3 (AOUTx3) default	P3_A=B 0	P3ATAPI4 0	P3ATAPI3 1	P3ATAPI2 0	P3ATAPI1 0	P3ATAPI0 1	P3FM1 0	P3FM0 0
0Dh	Vol. Control A3 default	A3_MUTE 0	A3_VOL6 0	A3_VOL5 0	A3_VOL4 0	A3_VOL3 0	A3_VOL2 0	A3_VOL1 0	A3_VOL0 0
0Eh	Vol. Control B3 default	B3_MUTE 0	B3_VOL6 0	B3_VOL5 0	B3_VOL4 0	B3_VOL3 0	B3_VOL2 0	B3_VOL1 0	B3_VOL0 0
12h	Chip Revision default	PART3 1	PART2 1	PART1 1	PART0 0	Reserved -	Reserved -	Reserved -	Reserved -

4. REGISTER DESCRIPTION

Note: All registers are read/write in I²C Mode and write-only in SPI, unless otherwise noted.

4.1 Mode Control 1 (address 01h)

7	6	5	4	3	2	1	0
CPEN	FREEZE	MCLKDIV	Reserved	DAC3_DIS	DAC2_DIS	DAC1_DIS	PDN
0	0	0	0	0	0	0	1

4.1.1 Control Port Enable (CPEN)

Default = 0
 0 - Disabled
 1 - Enabled

Function:

This bit defaults to 0, allowing the device to power-up in Stand-Alone Mode. The Control Port Mode can be accessed by setting this bit to 1. This will allow the operation of the device to be controlled by the registers and the pin definitions will conform to Control Port Mode. To accomplish a clean power-up, the user should write this bit within 10 ms following the release of Reset.

4.1.2 Freeze Controls (FREEZE)

Default = 0
 0 - Disabled
 1 - Enabled

Function:

This function allows modifications to be made to the registers without the changes taking effect until the FREEZE is disabled. To make multiple changes in the Control port registers take effect simultaneously, enable the FREEZE bit, make all register changes, then Disable the FREEZE bit.

4.1.3 Master Clock Divide Enable (MCLKDIV)

Default = 0
 0 - Disabled
 1 - Enabled

Function:

The MCLKDIV bit enables a circuit that divides the externally applied MCLK signal by 2 prior to all other internal circuitry.

4.1.4 DAC Pair Disable (DACx_DIS)

Default = 0
 0 - DAC Pair x Enabled
 1 - DAC Pair x Disabled

Function:

When the bit is set, the respective DAC channel pair (AOUTAx and AOUTBx) will remain in a reset state. It is advised that changes to these bits be made while the power-down (PDN) bit is enabled to eliminate the possibility of audible artifacts.

4.1.5 Power Down (PDN)

Default = 1
 0 - Disabled
 1 - Enabled

Function:

The entire device will enter a low-power state when this function is enabled, and the contents of the control registers are retained in this mode. The power-down bit defaults to 'enabled' on power-up and must be disabled before normal operation in Control Port Mode can occur.

4.2 Mode Control 2 (address 02h)

7	6	5	4	3	2	1	0
Reserved 0	DIF2 0	DIF1 0	DIF0 0	Reserved 0	SDIN3CLK 0	SDIN2CLK 0	SDIN1CLK 0

4.2.1 Digital Interface Format (DIF)

Default = 000 - Format 0 (Left Justified, up to 24-bit data)

Function:

These bits select the interface format for the serial audio input. The Functional Mode bits determine whether PCM or DSD Mode is selected.

PCM Mode: The required relationship between the Left/Right clock, serial clock and serial data is defined by the Digital Interface Format and the options are detailed in [Figures 33 to 38](#).

Note: While in PCM Mode, the DIF bits should only be changed when the power-down (PDN) bit is set to ensure proper switching from one mode to another.

DIF2	DIF1	DIF0	DESCRIPTION	Format	FIGURE
0	0	0	Left Justified, up to 24-bit data	0	33
0	0	1	I ² S, up to 24-bit data	1	34
0	1	0	Right Justified, 16-bit data	2	35
0	1	1	Right Justified, 24-bit data	3	36
1	0	0	Right Justified, 20-bit data	4	37
1	0	1	Right Justified, 18-bit data	5	38
1	1	0	Reserved		
1	1	1	Reserved		

Table 1. Digital Interface Formats - PCM Mode

DSD Mode: The relationship between the oversampling ratio of the DSD audio data and the required Master clock to DSD data rate is defined by the Digital Interface Format pins. An additional write of 99h to register 00h and 80h to register 1Ah is required to access the modes denoted with *.

DIF2	DIF1	DIFO	DESCRIPTION	Note
0	0	0	64x oversampled DSD data with a 4x MCLK to DSD data rate	
0	0	1	64x oversampled DSD data with a 6x MCLK to DSD data rate	*
0	1	0	64x oversampled DSD data with a 8x MCLK to DSD data rate	*
0	1	1	64x oversampled DSD data with a 12x MCLK to DSD data rate	*
1	0	0	128x oversampled DSD data with a 2x MCLK to DSD data rate	
1	0	1	128x oversampled DSD data with a 3x MCLK to DSD data rate	*
1	1	0	128x oversampled DSD data with a 4x MCLK to DSD data rate	*
1	1	1	128x oversampled DSD data with a 6x MCLK to DSD data rate	*

Table 2. Digital Interface Formats - DSD Mode

4.2.2 Serial Audio Data Clock Source (SDINXCLK)

Default = 0

0 - SDINx clocked by SCLK1 and LRCK1

1 - SDINx clocked by SCLK2 and LRCK2

Function:

The SDINxCLK bit specifies which SCLK/LRCK input pair is used to clock in the data on the given SDINx line. For more details see ["Clock Source Selection"](#) on page 29.

4.3 Mode Control 3 (address 03h)

7	6	5	4	3	2	1	0
SZC1	SZC0	SNGLVOL	RMP_UP	Reserved	AMUTE	MUTE1	MUTE0
1	0	0	0	0	1	0	0

4.3.1 Soft Ramp and Zero Cross Control (SZC)

Default = 10

00 - Immediate Change

01 - Zero Cross

10 - Soft Ramp

11 - Soft Ramp on Zero Crossings

Function:

Immediate Change

When Immediate Change is selected all level changes will take effect immediately in one step.

Zero Cross

Zero Cross Enable dictates that signal level changes, either by attenuation changes or muting, will occur on a signal zero crossing to minimize audible artifacts. The requested level change will occur after a timeout period between 512 and 1024 sample periods (10.7 ms to 21.3 ms at 48 kHz sample rate) if the signal does not encounter a zero crossing. The zero cross function is independently monitored and implemented for each channel.

Soft Ramp

Soft Ramp allows level changes, both muting and attenuation, to be implemented by incrementally ramping, in 1/8 dB steps, from the current level to the new level at a rate of 1 dB per 8 left/right clock periods.

Soft Ramp on Zero Crossing

Soft Ramp and Zero Cross Enable dictates that signal level changes, either by attenuation changes or muting, will occur in 1/8 dB steps and be implemented on a signal zero crossing. The 1/8 dB level change will occur after a timeout period between 512 and 1024 sample periods (10.7 ms to 21.3 ms at 48 kHz sample rate) if the signal does not encounter a zero crossing. The zero cross function is independently monitored and implemented for each channel.

4.3.2 **Single Volume Control (SNGLVOL)**

Default = 0
0 - Disabled
1 - Enabled

Function:

The individual channel volume levels are independently controlled by their respective Volume Control Bytes when this function is disabled. The volume on all channels is determined by the A1 Channel Volume Control Byte, and the other Volume Control Bytes are ignored when this function is enabled.

4.3.3 **Soft Volume Ramp-Up After Error (RMP_UP)**

Default = 0
0 - Disabled
1 - Enabled

Function:

An un-mute will be performed after executing a filter mode change, after a LRCK/MCLK ratio change or error, and after changing the Functional Mode. When this feature is enabled, this un-mute is effected, similar to attenuation changes, by the Soft and Zero Cross bits in the Mode Control 3 register. When disabled, an immediate un-mute is performed in these instances.

Note: For best results, it is recommended that this feature be used in conjunction with the RMP_DN bit.

4.3.4 **MUTE C Polarity (MUTE C+/-)**

Default = 0
0 - Active High
1 - Active Low

Function:

The active polarity of the MUTE C pin(s) is determined by this register. When set to 0 (default) the MUTE C pins are high when active. When set to 1 the MUTE C pin(s) are low when active.

Note: When the on board mute circuitry is designed for active low, the MUTE C outputs will be high (un-muted) for the period of time during reset and before this bit is enabled to 1.

4.3.5 Auto-Mute (AMUTE)

Default = 1
 0 - Disabled
 1 - Enabled

Function:

The Digital-to-Analog converter output will mute following the reception of 8192 consecutive audio samples of static 0 or -1. A single sample of non-static data will release the mute. Detection and muting is done independently for each channel. The quiescent voltage on the output will be retained and the Mute Control pin will go active during the mute period. The muting function is affected, similar to volume control changes, by the Soft and Zero Cross bits in the Mode Control 3 register.

4.3.6 Mute Pin Control (MUTEC1, MUTEC0)

Default = 00
 00 - Six mute control signals
 01, 10 - One mute control signal
 11 - Three mute control signals

Function:

Selects how the internal mute control signals are routed to the MUTEC1 through MUTEC6 pins. When set to '00', there is one mute control signal for each channel: AOUT1A on MUTEC1, AOUT1B on MUTEC2, etc. When set to either '01' or '10', there is a single mute control signal on the MUTEC1 pin. When set to '11', there are three mute control signals, one for each stereo pair: AOUT1A and AOUT1B on MUTEC1, AOUT2A and AOUT2B on MUTEC2, and AOUT3A and AOUT3B on MUTEC3.

4.4 Filter Control (address 04h)

7	6	5	4	3	2	1	0
Reserved	Reserved	Reserved	FILT_SEL	Reserved	DEM1	DEM0	RMP_DN
0	0	0	0	0	0	0	0

4.4.1 Interpolation Filter Select (FILT_SEL)

Default = 0
 0 - Fast roll-off
 1 - Slow roll-off

Function:

This Function allows the user to select whether the interpolation filter has a fast or slow roll off. For filter characteristics please see [Section 1. Characteristics and Specifications](#).

4.4.2 De-Emphasis Control (DEM)

Default = 00
 00 - Disabled
 01 - 44.1 kHz
 10 - 48 kHz
 11 - 32 kHz

Function:

Selects the appropriate digital filter to maintain the standard 15 μ s/50 μ s digital de-emphasis filter response at 32, 44.1 or 48 kHz sample rates. (see [Figure 39](#))

De-emphasis is only available in Single-Speed Mode.

4.4.3 Soft Ramp-Down Before Filter Mode Change (RMP_DN)

Default = 0

0 - Disabled

1 - Enabled

Function:

A mute will be performed prior to executing a filter mode change. When this feature is enabled, this mute is effected, similar to attenuation changes, by the Soft and Zero Cross bits in the Mode Control 3 register. When disabled, an immediate mute is performed prior to executing a filter mode change.

Note: For best results, it is recommended that this feature be used in conjunction with the RMP_UP bit.

4.5 Invert Control (address 05h)

7	6	5	4	3	2	1	0
Reserved	Reserved	INV_B3	INV_A3	INV_B2	INV_A2	INV_B1	INV_A1
0	0	0	0	0	0	0	0

4.5.1 Invert Signal Polarity (Inv_Xx)

Default = 0

0 - Disabled

1 - Enabled

Function:

When enabled, these bits will invert the signal polarity of their respective channels.

4.6 Mixing Control Pair 1 (Channels A1 & B1)(address 06h) Mixing Control Pair 2 (Channels A2 & B2)(address 09h) Mixing Control Pair 3 (Channels A3 & B3)(address 0Ch)

7	6	5	4	3	2	1	0
Px_A=B	PxATAPI4	PxATAPI3	PxATAPI2	PxATAPI1	PxATAPI0	PxFM1	PxFM0
0	0	1	0	0	1	0	0

4.6.1 Channel A Volume = Channel B Volume (A=B)

Default = 0

0 - Disabled

1 - Enabled

Function:

The AOUTAx and AOUTBx volume levels are independently controlled by the A and the B Channel Volume Control Bytes when this function is disabled. The volume on both AOUTAx and AOUTBx are determined by the A Channel Attenuation and Volume Control Bytes (per A-B pair), and the B Channel Bytes are ignored when this function is enabled.

4.6.2 ATAPI Channel Mixing and Muting (ATAPI)

Default = 01001 - AOUTAx=aL, AOUTBx=bR (Stereo)

Function:

The CS4362 implements the channel mixing functions of the ATAPI CD-ROM specification. The ATAPI functions are applied per A-B pair. Refer to [Table 3](#) and [Figure 41](#) for additional information.

ATAPI4	ATAPI3	ATAPI2	ATAPI1	ATAPI0	AOUTAx	AOUTBx
0	0	0	0	0	MUTE	MUTE
0	0	0	0	1	MUTE	bR
0	0	0	1	0	MUTE	bL
0	0	0	1	1	MUTE	$b[(L+R)/2]$
0	0	1	0	0	aR	MUTE
0	0	1	0	1	aR	bR
0	0	1	1	0	aR	bL
0	0	1	1	1	aR	$b[(L+R)/2]$
0	1	0	0	0	aL	MUTE
0	1	0	0	1	aL	bR
0	1	0	1	0	aL	bL
0	1	0	1	1	aL	$b[(L+R)/2]$
0	1	1	0	0	$a[(L+R)/2]$	MUTE
0	1	1	0	1	$a[(L+R)/2]$	bR
0	1	1	1	0	$a[(L+R)/2]$	bL
0	1	1	1	1	$a[(L+R)/2]$	$b[(L+R)/2]$
1	0	0	0	0	MUTE	MUTE
1	0	0	0	1	MUTE	bR
1	0	0	1	0	MUTE	bL
1	0	0	1	1	MUTE	$[(aL+bR)/2]$
1	0	1	0	0	aR	MUTE
1	0	1	0	1	aR	bR
1	0	1	1	0	aR	bL
1	0	1	1	1	aR	$[(bL+aR)/2]$
1	1	0	0	0	aL	MUTE
1	1	0	0	1	aL	bR
1	1	0	1	0	aL	bL
1	1	0	1	1	aL	$[(aL+bR)/2]$
1	1	1	0	0	$[(aL+bR)/2]$	MUTE
1	1	1	0	1	$[(aL+bR)/2]$	bR
1	1	1	1	0	$[(bL+aR)/2]$	bL
1	1	1	1	1	$[(aL+bR)/2]$	$[(aL+bR)/2]$

Table 3. ATAPI Decode

4.6.3 Functional Mode (FM)

Default = 00

00 - Single-Speed Mode (4 to 50 kHz sample rates)

01 - Double-Speed Mode (50 to 100 kHz sample rates)

10 - Quad-Speed Mode (100 to 200 kHz sample rates)

11 - Direct Stream Digital Mode

Function:

Selects the required range of input sample rates or DSD Mode. All DAC pairs set to the same SCLK/LRCK pair (Section 4.2.2) are required to be set to the same functional mode setting before a speed mode change is accepted. When DSD Mode is selected for any channel pair then all pairs will switch to DSD Mode.

4.7 Volume Control (addresses 07h, 08h, 0Ah, 0Bh, 0Dh, 0Eh)

7	6	5	4	3	2	1	0
xx_MUTE	xx_VOL6	xx_VOL5	xx_VOL4	xx_VOL3	xx_VOL2	xx_VOL1	xx_VOL0
0	0	0	0	0	0	0	0

4.7.1 Mute (MUTE)

Default = 0

0 - Disabled

1 - Enabled

Function:

The Digital-to-Analog converter output will mute when enabled. The quiescent voltage on the output will be retained. The muting function is effected, similar to attenuation changes, by the Soft and Zero Cross bits. The MUTE pins will go active during the mute period according to the MUTE bits.

4.7.2 Volume Control (xx_VOL)

Default = 0 (No attenuation)

Function:

The Digital Volume Control registers allow independent control of the signal levels in 1 dB increments from 0 to -127 dB. Volume settings are decoded as shown in Table 4. The volume changes are implemented as dictated by the Soft and Zero Cross bits. All volume settings less than -127 dB are equivalent to enabling the MUTE bit.

Binary Code	Decimal Value	Volume Setting
0000000	0	0 dB
0010100	20	-20 dB
0101000	40	-40 dB
0111100	60	-60 dB
1011010	90	-90 dB

Table 4. Example Digital Volume Settings

4.8 Chip Revision (address 12h)

7	6	5	4	3	2	1	0
PART3	PART2	PART1	PART0	Reserved	Reserved	Reserved	Reserved
1	1	1	0	-	-	-	-

4.8.1 Part Number ID (PART) [Read Only]

1110 - CS4362

Function:

This read-only register can be used to identify the model number of the device.

5. PIN DESCRIPTION

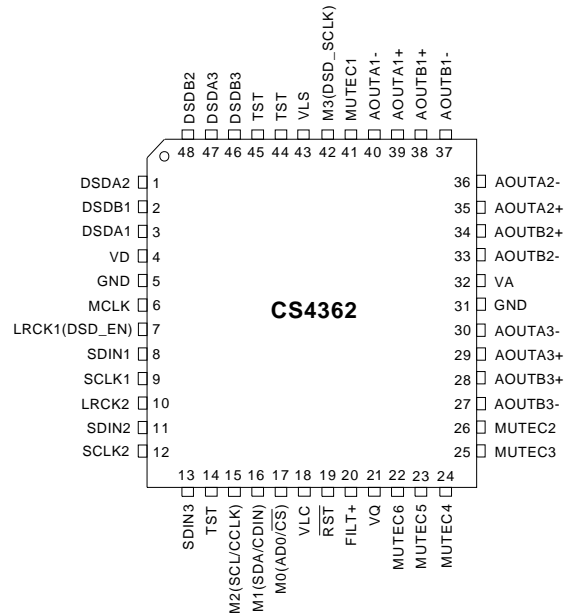

Pin Name	#	Pin Description
VD	4	Digital Power (Input) - Positive power supply for the digital section. Refer to the Recommended Operating Conditions for appropriate voltages.
GND	5 31	Ground (Input) - Ground reference. Should be connected to analog ground.
MCLK	6	Master Clock (Input) - Clock source for the delta-sigma modulator and digital filters. Table 5 illustrates several standard audio sample rates and the required master clock frequencies.
LRCK1 LRCK2	7 10	Left Right Clock (Input) - Determines which channel, Left or Right, is currently active on the serial audio data line. The frequency of the left/right clock must be at the audio sample rate, F_s .
SDIN1 SDIN2 SDIN3	8 11 13	Serial Data Input (Input) - Input for two's complement serial audio data.
SCLK1 SCLK2	9 12	Serial Clock (Input) - Serial clocks for the serial audio interface.
TST	14 44 45	Test - These pins need to be tied to analog ground.
RST	19	Reset (Input) - The device enters a low power mode and all internal registers are reset to their default settings when low.
VA	32	Analog Power (Input) - Positive power supply for the analog section. Refer to the Recommended Operating Conditions for appropriate voltages.
VLS	43	Serial Audio Interface Power (Input) - Determines the required signal level for the serial audio interface. Refer to the Recommended Operating Conditions for appropriate voltages.
VLC	18	Control Port Power (Input) - Determines the required signal level for the control port and stand-alone configuration pins. Refer to the Recommended Operating Conditions for appropriate voltages.

Pin Name	#	Pin Description
VQ	21	Quiescent Voltage (Output) - Filter connection for internal quiescent voltage. VQ must be capacitively coupled to analog ground, as shown in the Typical Connection Diagram. The nominal voltage level is specified in the Analog Characteristics and Specifications section. VQ presents an appreciable source impedance and any current drawn from this pin will alter device performance. However, VQ can be used to bias the analog circuitry assuming there is no AC signal component and the DC current is less than the maximum specified in the Analog Characteristics and Specifications section.
FILT+	20	Positive Voltage Reference (Output) - Positive reference voltage for the internal sampling circuits. Requires the capacitive decoupling to analog ground as shown in the Typical Connection Diagram.
AOUTA1 +,- AOUTB1 +,- AOUTA2 +,- AOUTB2 +,- AOUTA3 +,- AOUTB3 +,-	39,40 38,37 35,36 34,33 29,30 28,27	Differential Analog Output (Output) - The full-scale differential analog output level is specified in the Analog Characteristics specification table.
MUTEC1 MUTEC2 MUTEC3 MUTEC4 MUTEC5 MUTEC6	41 26 25 24 23 22	Mute Control (Output) - The Mute Control pins go high during power-up initialization, reset, muting, power-down or if the master clock to left/right clock frequency ratio is incorrect. These pins are intended to be used as a control for external mute circuits on the line outputs to prevent the clicks and pops that can occur in any single supply system. Use of Mute Control is not mandatory but recommended for designs requiring the absolute minimum in extraneous clicks and pops.
Stand-Alone Definitions		
M0 M1 M2 M3	17 16 15 42	Mode Selection (Input) - Determines the operational mode of the device as detailed in Tables 6 and 7 .
Control Port Definitions		
SCL/CCLK	15	Serial Control Port Clock (Input) - Serial clock for the serial control port. Requires an external pull-up resistor to the logic interface voltage in I ² C Mode as shown in the Typical Connection Diagram.
SDA/CDIN	16	Serial Control Port Data (Input/Output) - SDA is a data I/O line in I ² C Mode and is open drain, requiring an external pull-up resistor to the logic interface voltage, as shown in the Typical Connection Diagram; CDIN is the input data line for the control port interface in SPI Mode.
AD0/ $\overline{\text{CS}}$	17	Address Bit 0 (I²C) / Control Port Chip Select (SPI) (Input) - AD0 is a chip address pin in I ² C Mode; $\overline{\text{CS}}$ is the chip select signal for SPI Mode.
DSD Definitions		
DSDA1 DSDB1 DSDA2 DSDB2 DSDA3 DSDB3	3 2 1 48 47 46	Direct Stream Digital Input (Input) - Input for Direct Stream Digital serial audio data.
DSD_SCLK	42	DSD Serial Clock (Input) - Serial clock for the Direct Stream Digital serial audio interface.
DSD_EN	7	DSD Enable (Input) - When held at logic '1' the device will enter DSD Mode (Stand-Alone Mode only).

Mode (sample-rate range)	Sample Rate (kHz)	MCLK (MHz)				Control Port Only Modes
		MCLK Ratio	256x	384x	512x	
Single-Speed (4 to 50 kHz)	32	8.1920	12.2880	16.3840	24.5760	32.7680
	44.1	11.2896	16.9344	22.5792	33.8688	45.1584
	48	12.2880	18.4320	24.5760	36.8640	49.1520
Double-Speed (50 to 100 kHz)	64	8.1920	12.2880	16.3840	24.5760	32.7680
	88.2	11.2896	16.9344	22.5792	33.8688	45.1584
	96	12.2880	18.4320	24.5760	36.8640	49.1520
Quad-Speed (100 to 200 kHz)	176.4	11.2896	16.9344	22.5792	33.8688	45.1584
	192	12.2880	18.4320	24.5760	36.8640	49.1520

Table 5. Common Clock Frequencies

*Note: These modes are only available in Control Port Mode by setting the MCLKDIV bit = 1.

M1 (DIF1)	M0 (DIF0)	DESCRIPTION	FORMAT	FIGURE
0	0	Left Justified, up to 24-bit data	0	33
0	1	I ² S, up to 24-bit data	1	34
1	0	Right Justified, 16-bit Data	2	35
1	1	Right Justified, 24-bit Data	3	36

Table 6. Digital Interface Format, Stand-Alone Mode Options

M3	M2 (DEM)	DESCRIPTION
0	0	Single-Speed without De-Emphasis (4 to 50 kHz sample rates)
0	1	Single-Speed with 44.1 kHz De-Emphasis; see Figure 39
1	0	Double-Speed (50 to 100 kHz sample rates)
1	1	Quad-Speed (100 to 200 kHz sample rates)

Table 7. Mode Selection, Stand-Alone Mode Options

DSD_Mode (LRCK1)	M2	M1	M0	DESCRIPTION
1	0	0	0	64x oversampled DSD data with a 4x MCLK to DSD data rate
1	0	0	1	Reserved
1	0	1	0	Reserved
1	0	1	1	Reserved
1	1	0	0	128x oversampled DSD data with a 2x MCLK to DSD data rate
1	1	0	1	Reserved
1	1	1	0	Reserved
1	1	1	1	Reserved

Table 8. Direct Stream Digital (DSD), Stand-Alone Mode Options

6. APPLICATIONS

6.1 Grounding and Power Supply Decoupling

As with any high resolution converter, the CS4362 requires careful attention to power supply and grounding arrangements to optimize performance. [Figures 5 and 6](#) show the recommended power arrangement with VA, VD, VLS and VLC connected to clean supplies. Decoupling capacitors should be located as close to the device package as possible. If desired, all supply pins may be connected to the same supply, but a decoupling capacitor should still be placed on each supply pin (see [Characteristics and Specifications](#) for recommended voltages).

6.2 PCM Mode Select

The CS4362 operates in one of three PCM oversampling modes based on the input sample rate. Mode selection is determined by the M3 and M2 pins in Stand-Alone Mode or the FM bits in Control Port Mode. Single-Speed Mode supports input sample rates up to 50 kHz and uses a 128x oversampling ratio. Double-Speed Mode supports input sample rates up to 100 kHz and uses an oversampling ratio of 64x. Quad-Speed Mode supports input sample rates up to 200 kHz and uses an oversampling ratio of 32x. The PCM digital interface format is determined by the M1 and M0 pins in Stand-Alone Mode or the DIF bits in Control Port Mode.

In Stand-Alone Mode, the states of these pins are continually scanned for any changes; however, the mode should only be changed while the device is in reset ($\overline{\text{RST}}$ pin low) to ensure proper switching from one mode to another.

6.3 Recommended Power-Up Sequence

1. Hold $\overline{\text{RST}}$ low until the power supply, master, and left/right clocks are stable. In this state, the control port is reset to its default settings and VQ will remain low.
2. Bring $\overline{\text{RST}}$ high. The device will remain in a low power state with VQ low and will initiate the Stand-Alone power-up sequence. The control port will be accessible at this time. If Control Port operation is desired, write the CPEN bit prior to the completion of the Stand-Alone power-up sequence, approximately 512 LRCK cycles in Single-Speed Mode (1024 LRCK cycles in Double-Speed Mode, and 2048 LRCK cycles in Quad-Speed Mode). Writing this bit will halt the Stand-Alone power-up sequence and initialize the control port to its default settings. The desired register settings can be loaded while keeping the PDN bit set to 1.
3. If Control Port Mode is selected via the CPEN bit, set the RMP_UP and RMP_DN bits in registers 03h and 04h to 1, set the format and mode control bits to the desired settings, and then set the PDN bit to 0 which will initiate the power-up sequence.

6.4 Analog Output and Filtering

The application note “Design Notes for a 2-Pole Filter with Differential Input” discusses the second-order Butterworth filter and differential to single-ended converter which was implemented on the CS4362 evaluation board, CDB4362, as seen in [Figure 42](#). The CS4362 does not include phase or amplitude compensation for an external filter. Therefore, the DAC system phase and amplitude response will be dependent on the external analog circuitry.

6.5 Interpolation Filter

To accommodate the increasingly complex requirements of digital audio systems, the CS4362 incorporates selectable interpolation filters for each mode of operation. A “fast” and a “slow” roll-off filter is available in each of Single-, Double-, and Quad-Speed Modes. These filters have been designed to accommodate a

variety of musical tastes and styles. The `FILT_SEL` bit is used to select which filter is used (see the control port section for more details).

When in Stand-Alone Mode, only the “fast” roll-off filter is available.

Filter specifications can be found in [Section 1](#), and filter response plots can be found in [Figures 9 to 32](#).

6.6 Clock Source Selection

The CS4362 has two serial clock and two left/right clock inputs. The `SDINxCLK` bits in the control port allow the user to set which `SCLK/LRCK` pair is used to latch the data for each `SDINx` pin. The clocks applied to `LRCK1` and `LRCK2` must be derived from the same `MCLK` and must be exact frequency multiples of each other as specified in the [“Switching Characteristics” on page 9](#). When using both `SCLK1/LRCK1` and `SCLK2/LRCK2`, if either `SCLK/LRCK` pair loses synchronization then both `SCLK/LRCK` pairs will go through a retime period where the device is re-evaluating clock ratios. During the retime period, all DAC pairs are temporarily inactive, outputs are muted, and the mute control pins will go active according to the `MUTE` bits.

If unused, `SCLK2` and `LRCK2` should be tied static low and `SDINx` bits should all be set to `SCLK1/LRCK1`.

In Stand-Alone Mode, all DAC pairs use `SCLK1` and `LRCK1` for timing and `SCLK2/LRCK2` should be tied to ground.

6.7 Using DSD Mode

In Stand-Alone Mode, DSD operation is selected by holding `DSD_EN(LRCK1)` high and applying the DSD data and clocks to the appropriate pins. The `M2:0` pins set the expected DSD rate and `MCLK` ratio.

In Control-Port Mode, the `FM` bits set the device into DSD Mode (`DSD_EN` pin is not required to be held high). The `DIF` register then controls the expected DSD rate and `MCLK` ratio. To access the full range of DSD clocking modes (other than `64x DSD 4x MCLK` and `128x DSD 2x MCLK`), the following additional register sequence needs to be written:

```
99h to register 00h
80h to register 1Ah
00h to register 00h
```

When exiting DSD Mode the following additional sequence needs to be written:

```
99h to register 00h
00h to register 1Ah
00h to register 00h
```

During DSD operation, the PCM related pins should either be tied low or remain active with clocks (except `LRCK1` in Stand-Alone Mode). When the DSD related pins are not being used, they should either be tied static low or remain active with clocks (except `M3` in Stand-Alone Mode).

6.8 Recommended Procedure for Switching Operational Modes

For systems where the absolute minimum in clicks and pops is required, it is recommended that the `MUTE` bits are set prior to changing significant DAC functions (such as changing sample rates or clock sources). The mute bits may then be released after clocks have settled and the proper CS4362 modes have been set.

It is required that the CS4362 be held in reset if the minimum high/low time specs of `MCLK` can not be met during clock source changes.

7. CONTROL PORT INTERFACE

The control port is used to load all the internal settings. The operation of the control port may be completely asynchronous with the audio sample rate. However, to avoid potential interference problems, the control port pins should remain static if no operation is required.

The CS4362 has MAP auto increment capability, enabled by the INCR bit in the MAP register, which is the MSB. If INCR is 0, then the MAP will stay constant for successive writes. If INCR is set to 1, then MAP will auto increment after each byte is written from register 01h to 08h and then from 09h and 11h, allowing block reads or writes of successive registers in two separate sections (the counter will not auto-increment to register 09h from register 08h).

7.1 Enabling the Control Port

On the CS4362 the control port pins are shared with stand-alone configuration pins. To enable the control port, the user must set the CPEN bit. This is done by performing a I²C or SPI write. Once the control port is enabled, these pins are dedicated to control port functionality.

To prevent audible artifacts the CPEN bit (see [Section 4.1.1](#)) should be set prior to the completion of the Stand-Alone power-up sequence, approximately 1024 LRCK cycles. Writing this bit will halt the Stand-Alone power-up sequence and initialize the control port to its default settings. Note, the CP_EN bit can be set any time after $\overline{\text{RST}}$ goes high; however, setting this bit after the Stand-Alone power-up sequence has completed can cause audible artifacts.

7.2 Format Selection

The control port has 2 formats: SPI and I²C, with the CS4362 operating as a slave device.

If I²C operation is desired, $\overline{\text{AD0/CS}}$ should be tied to VLC or GND. If the CS4362 ever detects a high to low transition on $\overline{\text{AD0/CS}}$ after power-up and after the control port is activated, SPI format will be selected.

7.3 I²C Format

In I²C Format, SDA is a bidirectional data line. Data is clocked into and out of the part by the clock, SCL, with a clock to data relationship as shown in [Figure 7](#). The receiving device should send an acknowledge (ACK) after each byte received. There is no $\overline{\text{CS}}$ pin. Pin AD0 forms the partial chip address and should be tied to VLC or GND as required. The upper 6 bits of the 7 bit address field must be 001100.

Note: MCLK is required during all I²C transactions. Please see “References” on page 40 to obtain additional information on the I²C Bus specification or visit <http://www.semiconductors.philips.com>.

7.3.1 Writing in I²C Format

To communicate with the CS4362, initiate a START condition of the bus. Next, send the chip address. The eighth bit of the address byte is the R/W bit (low for a write). The next byte is the Memory Address Pointer, MAP, which selects the register to be read or written. The MAP is then followed by the data to be written. To write multiple registers, continue providing a clock and data, waiting for the CS4362 to acknowledge between each byte. To end the transaction, send a STOP condition.

7.3.2 Reading in I²C Format

To communicate with the CS4362, initiate a START condition of the bus. Next, send the chip address. The eighth bit of the address byte is the R/W bit (high for a read). The contents of the register pointed to by the MAP will be output after the chip address. To read multiple registers, continue providing a clock and issue an ACK after each byte. To end the transaction, send a STOP condition.

7.4 SPI Format

In SPI format, \overline{CS} is the CS4362 chip select signal, CCLK is the control port bit clock, CDIN is the input data line from the microcontroller and the chip address is 0011000. \overline{CS} , CCLK and CDIN are all inputs and data is clocked in on the rising edge of CCLK.

Note: The CS4362 is write-only when in SPI format.

7.4.1 Writing in SPI

Figure 8 shows the operation of the control port in SPI format. To write to a register, bring \overline{CS} low. The first 7 bits on CDIN form the chip address and must be 0011000. The eighth bit is a read/write indicator ($\overline{R/W}$), which must be low to write. The next 8 bits form the Memory Address Pointer (MAP), which is set to the address of the register that is to be updated. The next 8 bits are the data which will be placed into register designated by the MAP. To write multiple registers, keep \overline{CS} low and continue providing clocks on CCLK. End the read transaction by setting \overline{CS} high.

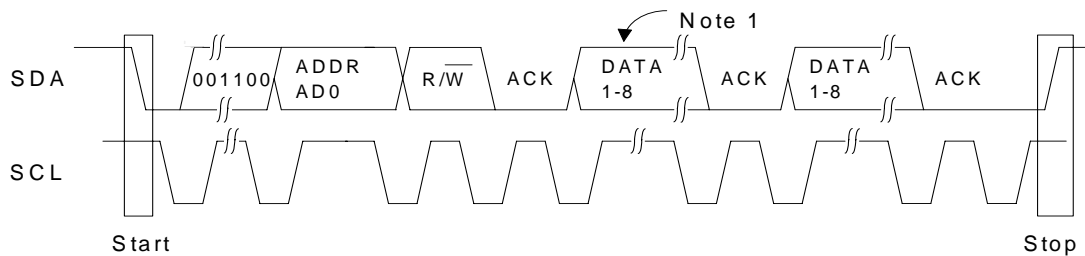

Note: If operation is a write, this byte contains the Memory Address Pointer, MAP.

Figure 7. Control Port Timing, I²C Format

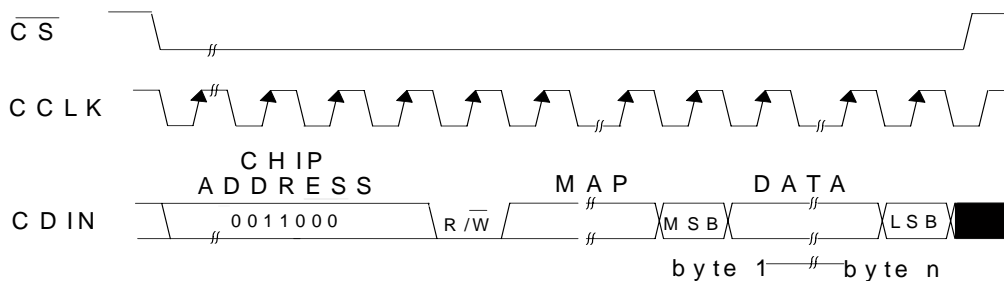

MAP = Memory Address Pointer

Figure 8. Control Port Timing, SPI Format

7.5 Memory Address Pointer (MAP)

7	6	5	4	3	2	1	0
INCR	Reserved	Reserved	MAP4	MAP3	MAP2	MAP1	MAP0
0	0	0	0	0	0	0	0

7.5.1 INCR (Auto Map Increment Enable)

Default = '0'

0 - Disabled

1 - Enabled

Note: When Auto Map Increment is enabled, the register must be written in two separate blocks: from register 01h to 08h and then from 09h and 11h. The counter will not auto-increment to register 09h from register 08h

7.5.2 MAP4-0 (Memory Address Pointer)

Default = '00000'

8. FILTER PLOTS

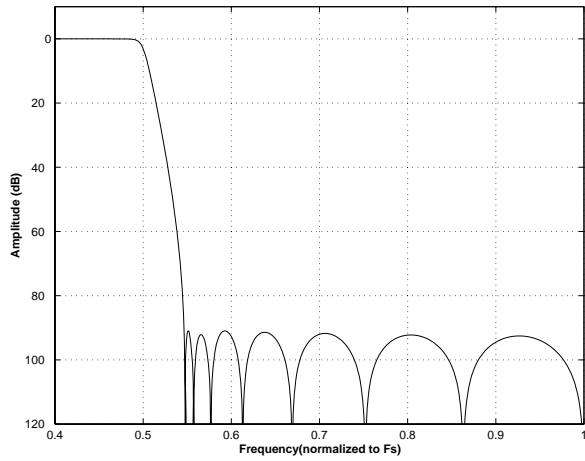

Figure 9. Single-Speed (fast) Stopband Rejection

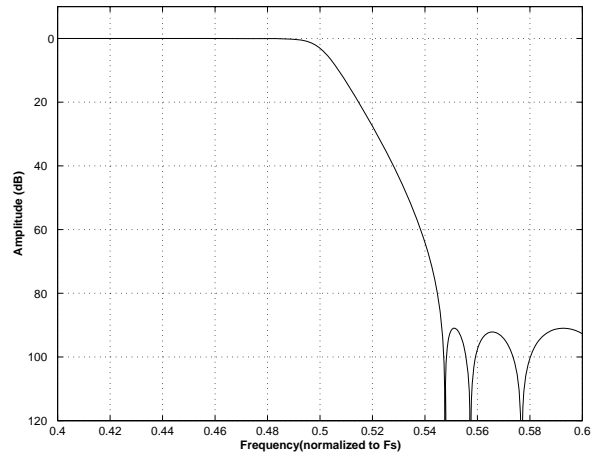

Figure 10. Single-Speed (fast) Transition Band

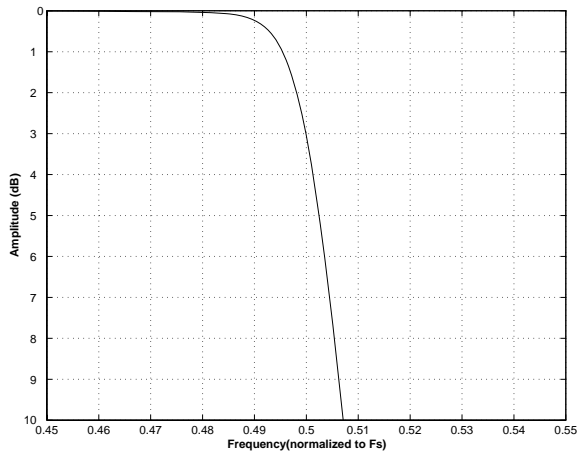

Figure 11. Single-Speed (fast) Transition Band (detail)

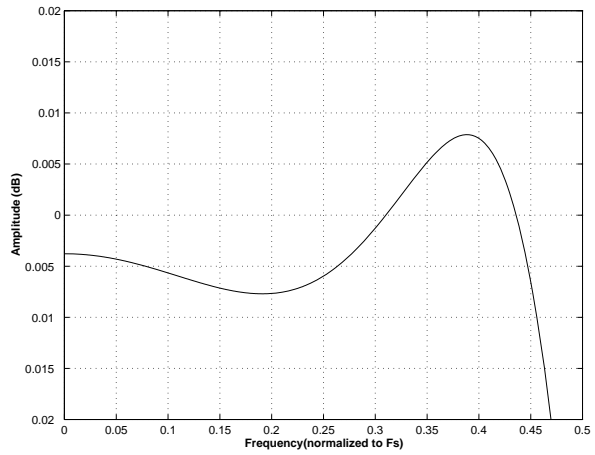

Figure 12. Single-Speed (fast) Passband Ripple

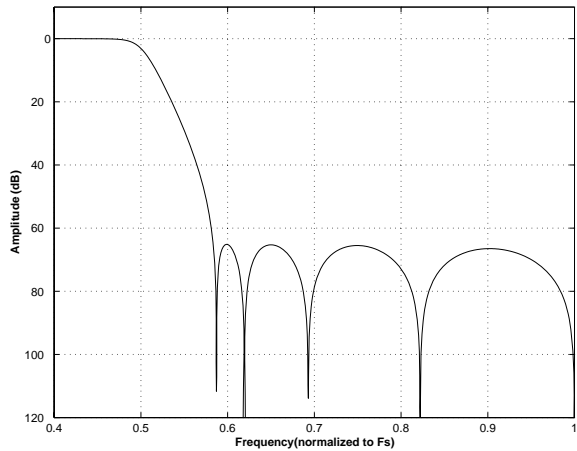

Figure 13. Single-Speed (slow) Stopband Rejection

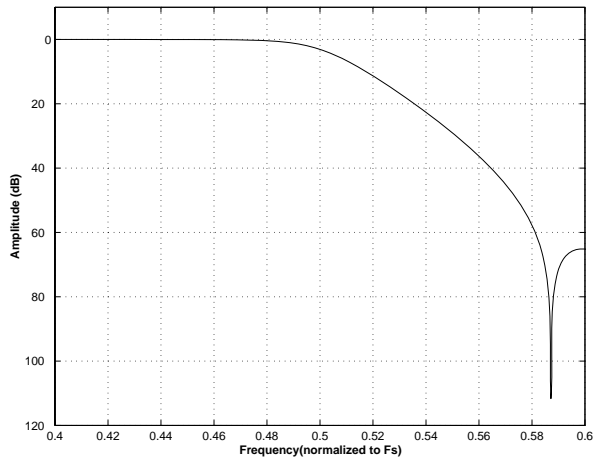

Figure 14. Single-Speed (slow) Transition Band

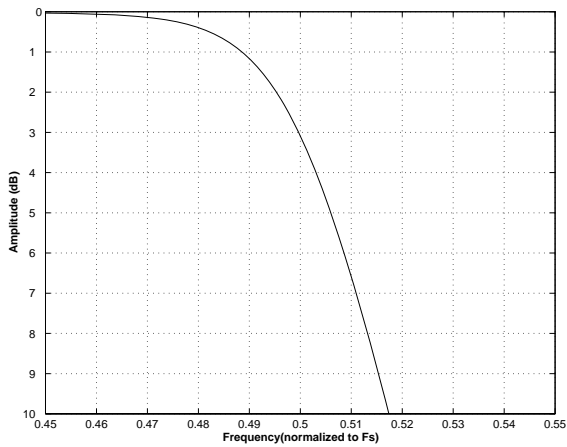

Figure 15. Single-Speed (slow) Transition Band (detail)

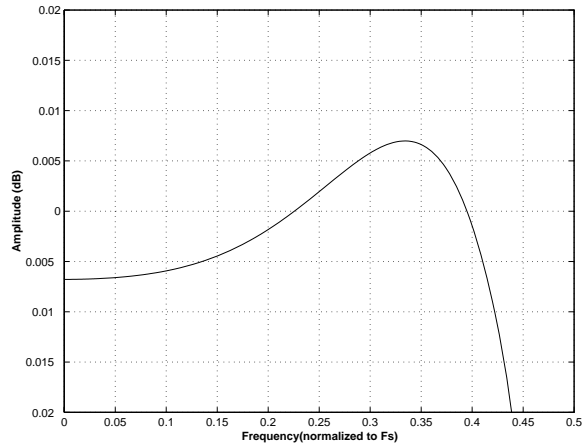

Figure 16. Single-Speed (slow) Passband Ripple

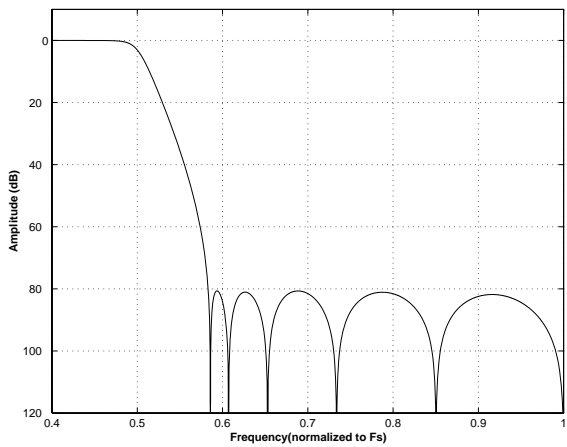

Figure 17. Double-Speed (fast) Stopband Rejection

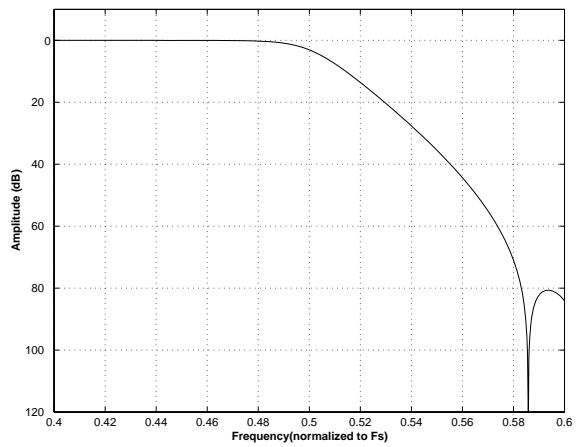

Figure 18. Double-Speed (fast) Transition Band

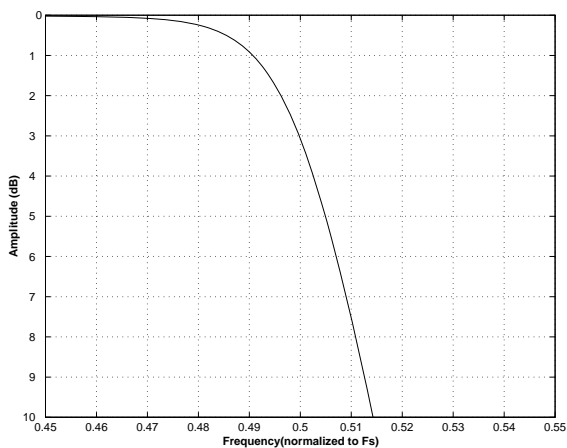

Figure 19. Double-Speed (fast) Transition Band (detail)

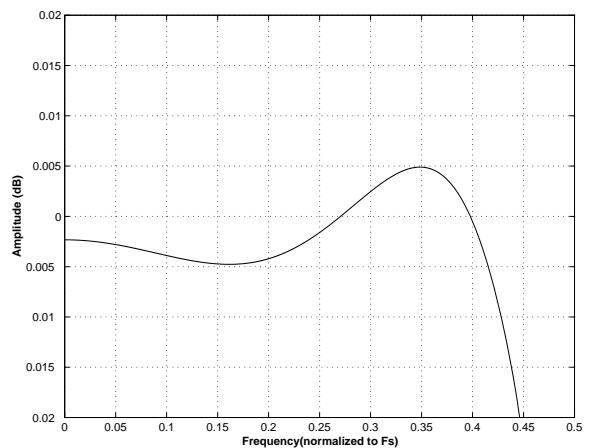
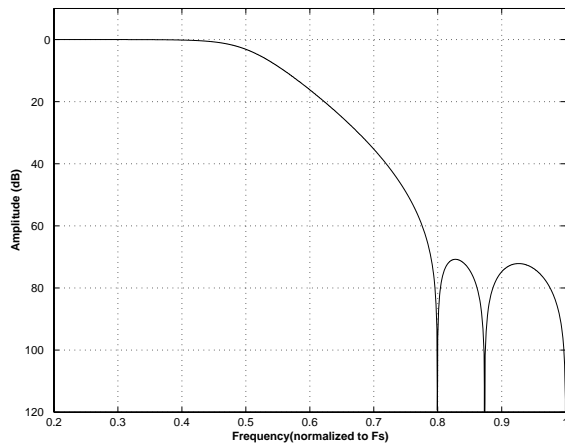
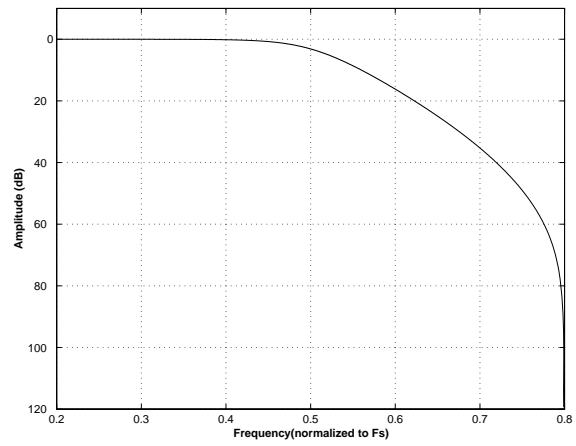
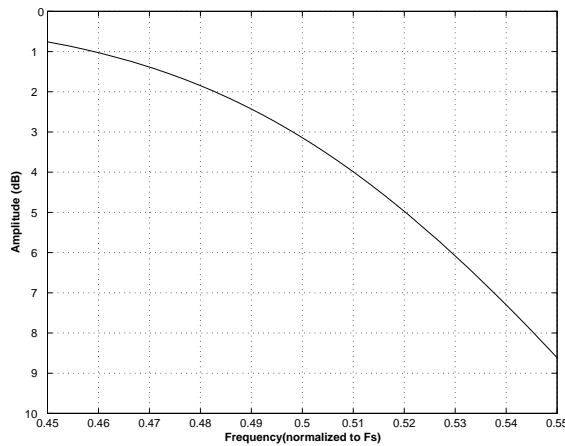
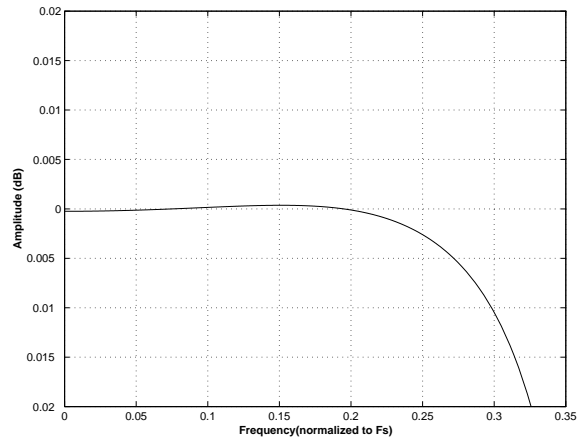
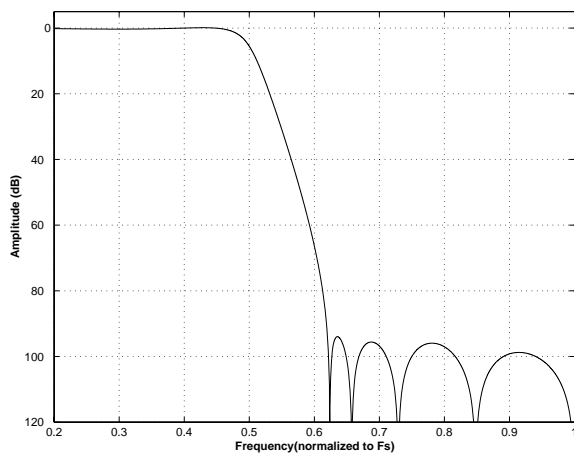
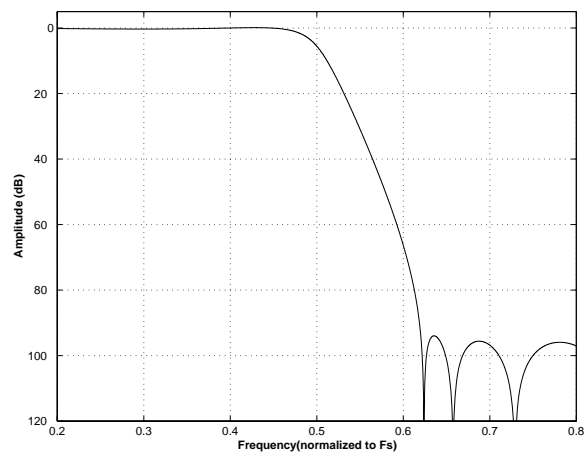
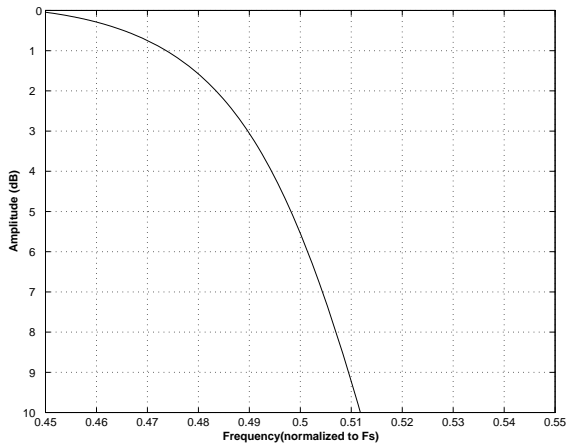
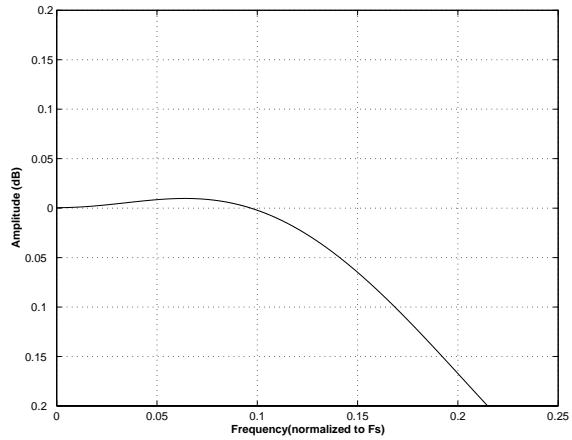
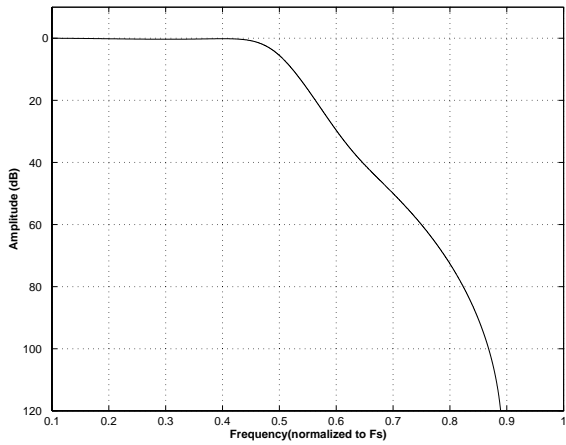
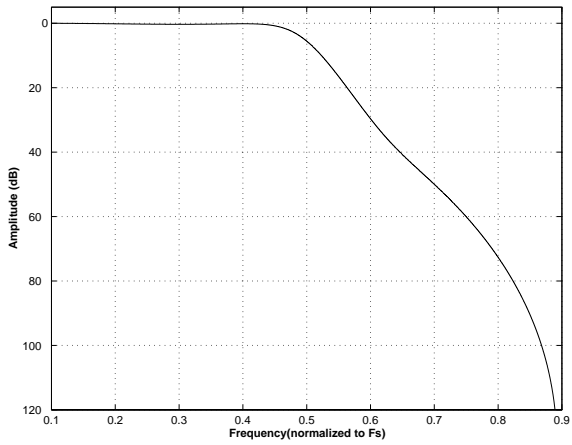
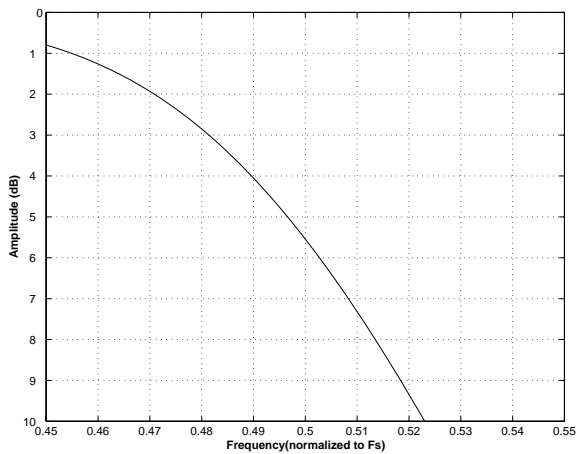
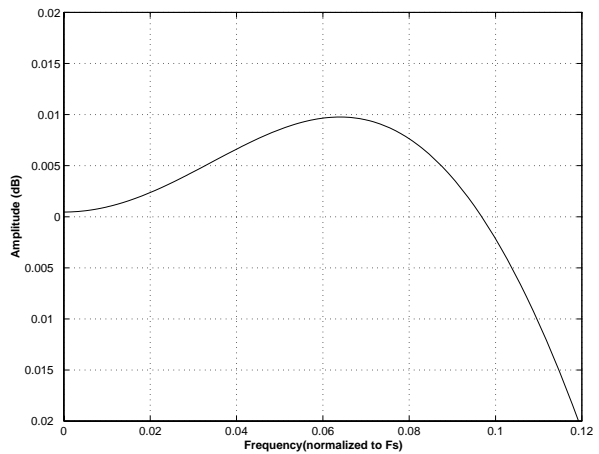

Figure 20. Double-Speed (fast) Passband Ripple

Figure 21. Double-Speed (slow) Stopband Rejection

Figure 22. Double-Speed (slow) Transition Band

Figure 23. Double-Speed (slow) Transition Band (detail)

Figure 24. Double-Speed (slow) Passband Ripple

Figure 25. Quad-Speed (fast) Stopband Rejection

Figure 26. Quad-Speed (fast) Transition Band

Figure 27. Quad-Speed (fast) Transition Band

Figure 28. Quad-Speed (fast) Passband Ripple

Figure 29. Quad-Speed (slow) Stopband Rejection

Figure 30. Quad-Speed (slow) Transition Band

Figure 31. Quad-Speed (slow) Transition Band (detail)

Figure 32. Quad-Speed (slow) Passband Ripple

9. DIAGRAMS

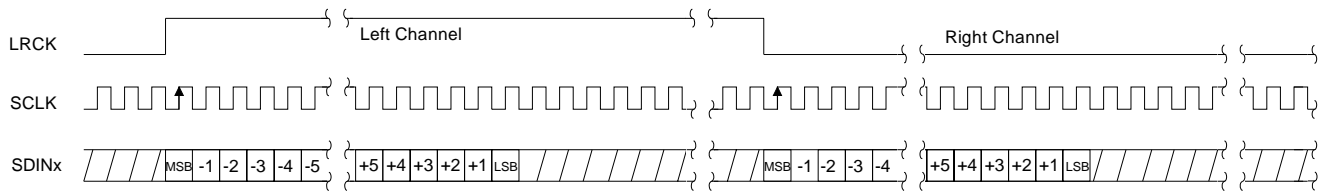

Figure 33. Format 0 - Left Justified up to 24-bit Data

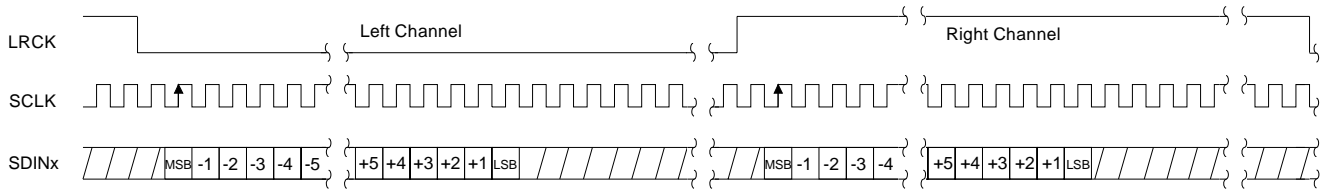

Figure 34. Format 1 - I²S up to 24-bit Data

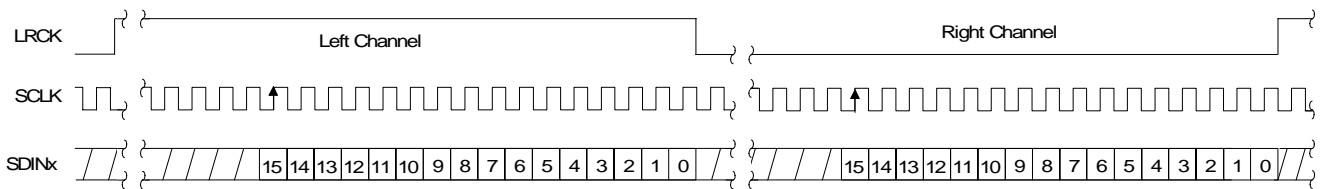

Figure 35. Format 2 - Right Justified 16-bit Data

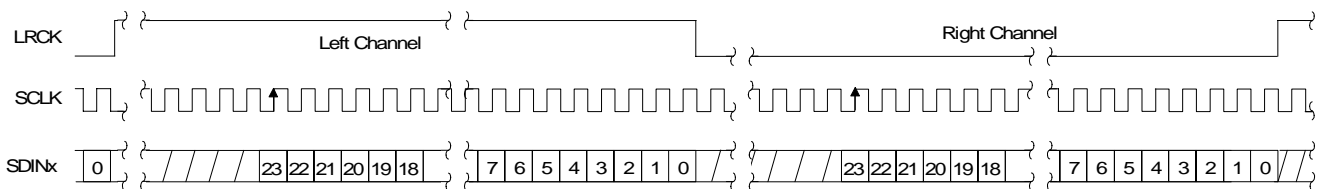
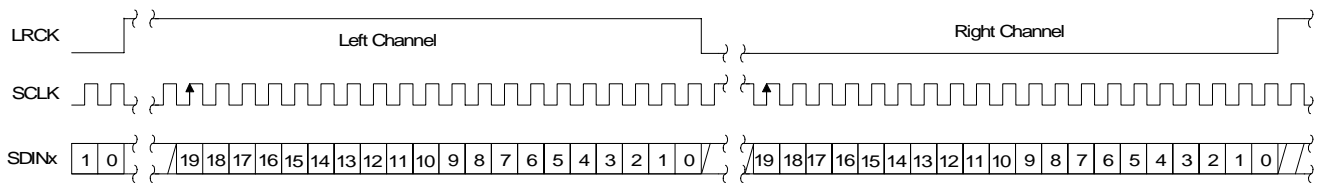
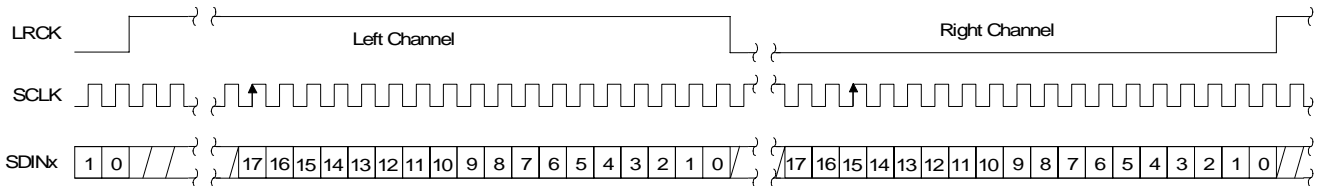
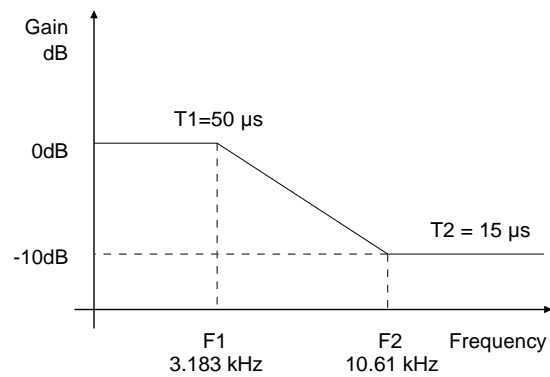

Figure 36. Format 3 - Right Justified 24-bit Data

Figure 37. Format 4 - Right Justified 20-bit Data

Figure 38. Format 5 - Right Justified 18-bit Data

Figure 39. De-Emphasis Curve

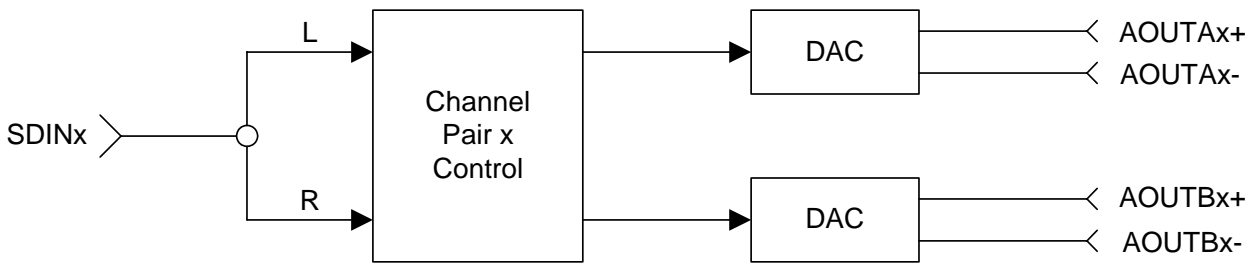

Figure 40. Channel Pair Routing Diagram (x = Channel Pair 1, 2, or 3)

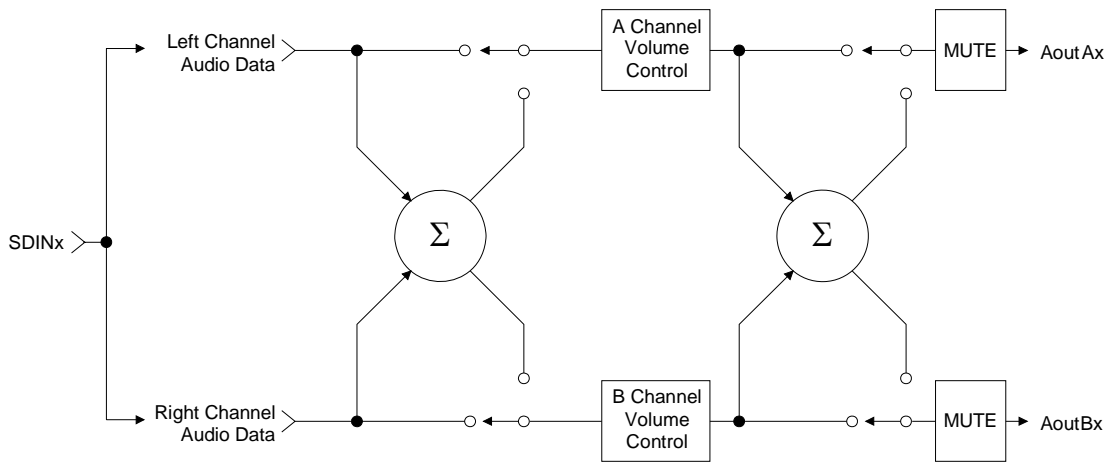

Figure 41. ATAPI Block Diagram (x = channel pair 1, 2, or 3)

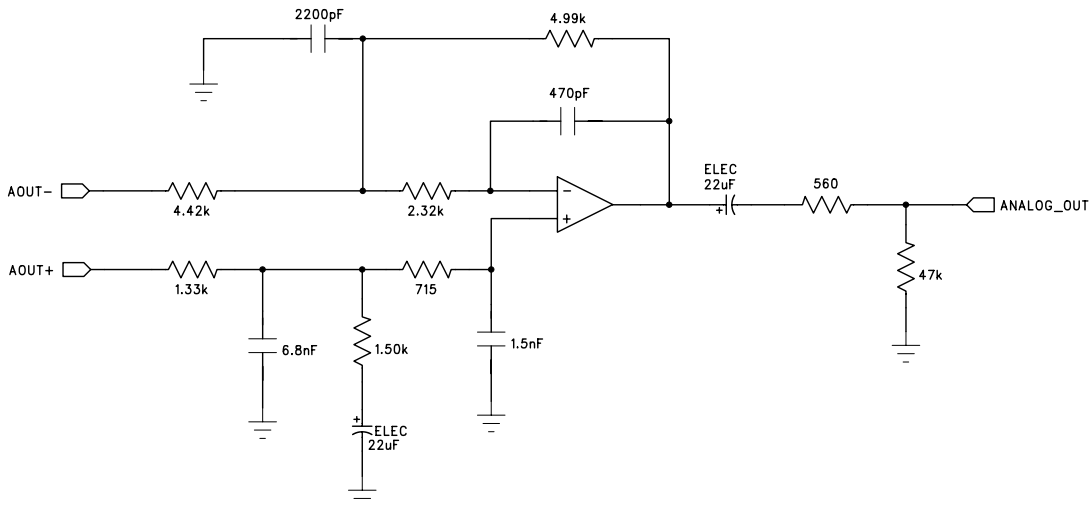

Figure 42. Recommended Output Filter

10. PARAMETER DEFINITIONS

Total Harmonic Distortion + Noise (THD+N)

The ratio of the rms value of the signal to the rms sum of all other spectral components over the specified bandwidth (typically 10 Hz to 20 kHz), including distortion components. Expressed in decibels.

Dynamic Range

The ratio of the full-scale rms value of the signal to the rms sum of all other spectral components over the specified bandwidth. Dynamic range is a signal-to-noise measurement over the specified bandwidth made with a -60 dBFS signal. 60 dB is then added to the resulting measurement to refer the measurement to full scale. This technique ensures that the distortion components are below the noise level and do not effect the measurement. This measurement technique has been accepted by the Audio Engineering Society, AES17-1991, and the Electronic Industries Association of Japan, EIAJ CP-307.

Interchannel Isolation

A measure of crosstalk between the left and right channels. Measured for each channel at the converter's output with all zeros to the input under test and a full-scale signal applied to the other channel. Units in decibels.

Interchannel Gain Mismatch

The gain difference between left and right channels. Units in decibels.

Gain Error

The deviation from the nominal full scale analog output for a full scale digital input.

Gain Drift

The change in gain value with temperature. Units in ppm/°C.

11. REFERENCES

1. *How to Achieve Optimum Performance from Delta-Sigma A/D & D/A Converters* by Steven Harris. Paper presented at the 93rd Convention of the Audio Engineering Society, October 1992.
2. CDB4362 Evaluation Board Data Sheet, available at <http://www.cirrus.com>.
3. *Design Notes for a 2-Pole Filter with Differential Input* by Steven Green. Cirrus Logic Application Note AN48, available at <http://www.cirrus.com>.
4. *The I²C-Bus Specification: Version 2.0*, Philips Semiconductors, December 1998. <http://www.semiconductors.philips.com>

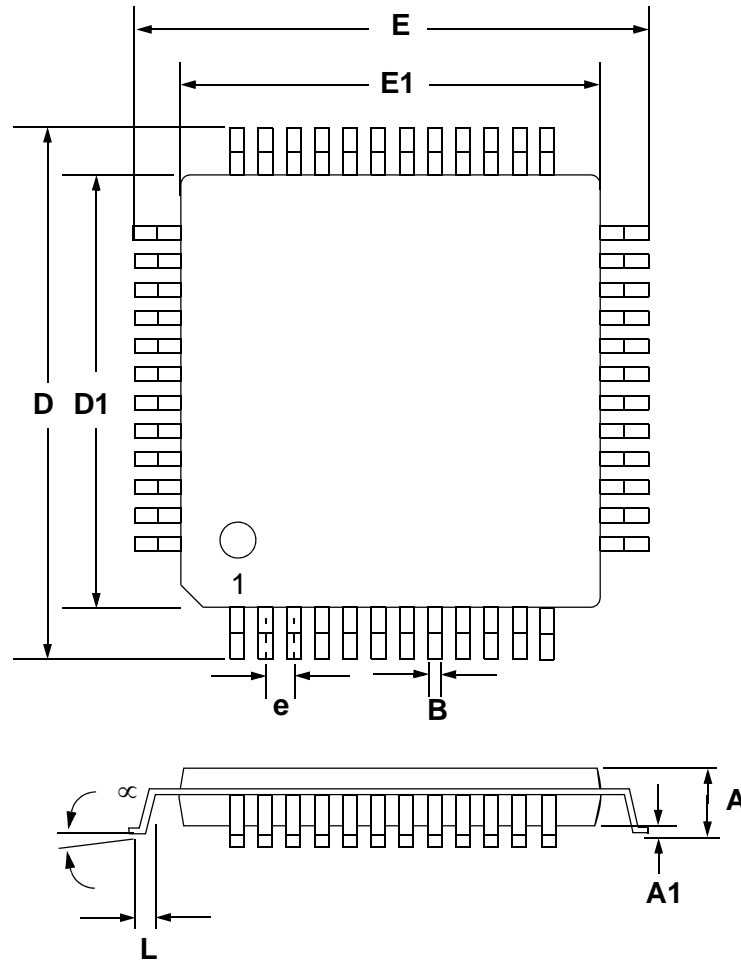
12.PACKAGE DIMENSIONS
48L LQFP PACKAGE DRAWING

DIM	INCHES			MILLIMETERS		
	MIN	NOM	MAX	MIN	NOM	MAX
A	---	0.055	0.063	---	1.40	1.60
A1	0.002	0.004	0.006	0.05	0.10	0.15
B	0.007	0.009	0.011	0.17	0.22	0.27
D	0.343	0.354	0.366	8.70	9.0 BSC	9.30
D1	0.272	0.28	0.280	6.90	7.0 BSC	7.10
E	0.343	0.354	0.366	8.70	9.0 BSC	9.30
E1	0.272	0.28	0.280	6.90	7.0 BSC	7.10
e*	0.016	0.020	0.024	0.40	0.50 BSC	0.60
L	0.018	0.24	0.030	0.45	0.60	0.75
∞	0.000°	4°	7.000°	0.00°	4°	7.00°

* Nominal pin pitch is 0.50 mm
Controlling dimension is mm.
JEDEC Designation: MS022

13. ORDERING INFORMATION

Product	Description	Package	Pb-Free	Grade	Temp Range	Container	Order #
CS4362	114 dB, 192 kHz 6-channel D/A Converter	48-pin LQFP	YES	Commercial	-10°C to +70°C	Tray	CS4362-KQZ
						Tape and Reel	CS4362-KQZR
CDB4362	CS4362 Evaluation Board		-	-	-	-	CDB4362

14. REVISION HISTORY

Release	Changes
F1	<p>Removed -BQ ordering option</p> <p>Corrected specifications for Full-Scale Differential Output Voltage</p> <p>Updated legal text</p> <p>Incorporated changes outlined in ER257B3 and ER257F1:</p> <p>Corrected pin order for analog outputs in the pin description</p> <p>Corrected mute pin decode in Section 4.3.6</p> <p>Updated description for Section 4.6.3</p> <p>Updated description for 3) in Section 6.3</p> <p>Added Section 6.8</p> <p>Updated Table 2 on page 18</p> <p>Updated Section 6.7 "Using DSD Mode" on page 29</p>
F2	<p>Corrected DAC Pair Disable register description in Section 4.1.4</p> <p>Added note to Digital Interface Format in Section 4.2.1</p> <p>Added PCM mode format changeable in reset only to Section 6.2</p> <p>Updated Package Thermal Resistance in "Power and Thermal Characteristics" on page 6</p>

Contacting Cirrus Logic Support

For all product questions and inquiries, contact a Cirrus Logic Sales Representative.
To find the one nearest you, go to www.cirrus.com.

IMPORTANT NOTICE

Cirrus Logic, Inc. and its subsidiaries ("Cirrus") believe that the information contained in this document is accurate and reliable. However, the information is subject to change without notice and is provided "AS IS" without warranty of any kind (express or implied). Customers are advised to obtain the latest version of relevant information to verify, before placing orders, that information being relied on is current and complete. All products are sold subject to the terms and conditions of sale supplied at the time of order acknowledgment, including those pertaining to warranty, indemnification, and limitation of liability. No responsibility is assumed by Cirrus for the use of this information, including use of this information as the basis for manufacture or sale of any items, or for infringement of patents or other rights of third parties. This document is the property of Cirrus and by furnishing this information, Cirrus grants no license, express or implied under any patents, mask work rights, copyrights, trademarks, trade secrets or other intellectual property rights. Cirrus owns the copyrights associated with the information contained herein and gives consent for copies to be made of the information only for use within your organization with respect to Cirrus integrated circuits or other products of Cirrus. This consent does not extend to other copying such as copying for general distribution, advertising or promotional purposes, or for creating any work for resale.

CERTAIN APPLICATIONS USING SEMICONDUCTOR PRODUCTS MAY INVOLVE POTENTIAL RISKS OF DEATH, PERSONAL INJURY, OR SEVERE PROPERTY OR ENVIRONMENTAL DAMAGE ("CRITICAL APPLICATIONS"). CIRRUS PRODUCTS ARE NOT DESIGNED, AUTHORIZED OR WARRANTED FOR USE IN PRODUCTS SURGICALLY IMPLANTED INTO THE BODY, AUTOMOTIVE SAFETY OR SECURITY DEVICES, LIFE SUPPORT PRODUCTS OR OTHER CRITICAL APPLICATIONS. INCLUSION OF CIRRUS PRODUCTS IN SUCH APPLICATIONS IS UNDERSTOOD TO BE FULLY AT THE CUSTOMER'S RISK AND CIRRUS DISCLAIMS AND MAKES NO WARRANTY, EXPRESS, STATUTORY OR IMPLIED, INCLUDING THE IMPLIED WARRANTIES OF MERCHANTABILITY AND FITNESS FOR PARTICULAR PURPOSE, WITH REGARD TO ANY CIRRUS PRODUCT THAT IS USED IN SUCH A MANNER. IF THE CUSTOMER OR CUSTOMER'S CUSTOMER USES OR PERMITS THE USE OF CIRRUS PRODUCTS IN CRITICAL APPLICATIONS, CUSTOMER AGREES, BY SUCH USE, TO FULLY INDEMNIFY CIRRUS, ITS OFFICERS, DIRECTORS, EMPLOYEES, DISTRIBUTORS AND OTHER AGENTS FROM ANY AND ALL LIABILITY, INCLUDING ATTORNEYS' FEES AND COSTS, THAT MAY RESULT FROM OR ARISE IN CONNECTION WITH THESE USES.

Cirrus Logic, Cirrus, and the Cirrus Logic logo designs are trademarks of Cirrus Logic, Inc. All other brand and product names in this document may be trademarks or service marks of their respective owners.

IPC is a registered trademark of Philips Semiconductor.

SPI is a trademark of Motorola, Inc.