

## Optocoupler, Photodarlington Output, High Gain, 300 $V_{CEO}$

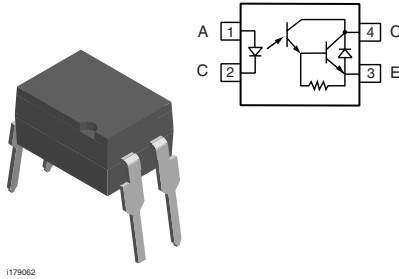

1179062

### DESCRIPTION

The SFH619A is optically coupled isolators with a gallium arsenide infrared LED and a silicon photodarlington sensor. Switching can be achieved while maintaining a high degree of isolation between driving and load circuits. These optocouplers can be used to replace reed and mercury relays with advantages of long life, high speed switching and elimination of magnetic fields.

### FEATURES

- High collector emitter voltage,  $V_{CEO} = 300\text{ V}$
- High isolation test voltage:  $5300\text{ V}_{RMS}$
- Standard plastic DIP-4 package
- Compatible with Toshiba TLP627
- Lead (Pb)-free component
- Component in accordance to RoHS 2002/95/EC and WEEE 2002/96/EC

**RoHS  
COMPLIANT**

### AGENCY APPROVALS

- UL - file no. E52744 system code H or J
- DIN EN 60747-5-2 (VDE 0884)/DIN EN 60747-5-5 pending available with option 1
- BSI IEC 60950; IEC 60065
- FIMKO

### ORDER INFORMATION

PART	REMARKS
SFH619A	CTR > 1000 %, DIP-4
SFH619A-X007	CTR > 1000 %, SMD-4 (option 7)
SFH619A-X009	CTR > 1000 %, SMD-4 (option 9)

#### Note

For additional information on the available options refer to option information.

### ABSOLUTE MAXIMUM RATINGS (1)

PARAMETER	TEST CONDITION	SYMBOL	VALUE	UNIT
<b>INPUT</b>				
Peak reverse voltage		$V_{RM}$	6.0	V
Forward continuous current		$I_F$	60	mA
Derate linearly from 25 °C			1.33	mW/°C
Power dissipation		$P_{diss}$	100	mW
<b>OUTPUT</b>				
Collector emitter breakdown voltage		$BV_{CEO}$	300	V
Emitter collector breakdown voltage		$BV_{ECO}$	0.3	V
Collector (load) current		$I_C$	125	mA
Derate linearly from 25 °C			2.0	mW/°C
Power dissipation		$P_{diss}$	150	mW
<b>COUPLER</b>				
Derate linearly from 25 °C			3.33	mW/°C
Total power dissipation		$P_{tot}$	250	mW
Isolation test voltage between emitter and detector, standard climate: 23 °C/50 % RH, DIN 50014	$t = 1.0\text{ s}$	$V_{ISO}$	5300	$V_{RMS}$

ABSOLUTE MAXIMUM RATINGS (1)				
PARAMETER	TEST CONDITION	SYMBOL	VALUE	UNIT
<b>COUPLER</b>				
Isolation resistance	V <sub>IO</sub> = 500 V, T <sub>amb</sub> = 25 °C	R <sub>IO</sub>	≥ 10 <sup>12</sup>	Ω
	V <sub>IO</sub> = 500 V, T <sub>amb</sub> = 100 °C	R <sub>IO</sub>	≥ 10 <sup>11</sup>	Ω
Storage temperature		T <sub>stg</sub>	- 55 to + 150	°C
Operating temperature		T <sub>amb</sub>	- 55 to + 100	°C
Soldering temperature (2)	max. 10 s, dip soldering: distance to seating plane ≥ 1.5 mm	T <sub>slid</sub>	260	°C

**Notes**(1) T<sub>amb</sub> = 25 °C, unless otherwise specified.

Stresses in excess of the absolute maximum ratings can cause permanent damage to the device. Functional operation of the device is not implied at these or any other conditions in excess of those given in the operational sections of this document. Exposure to absolute maximum ratings for extended periods of the time can adversely affect reliability.

(2) Refer to reflow profile for soldering conditions for surface mounted devices (SMD). Refer to wave profile for soldering conditions for through hole devices (DIP).

ELECTRICAL CHARACTERISTICS						
PARAMETER	TEST CONDITION	SYMBOL	MIN.	TYP.	MAX.	UNIT
<b>INPUT</b>						
Forward voltage	I <sub>F</sub> = 10 mA	V <sub>F</sub>		1.2	1.5	V
Reverse current	V <sub>R</sub> = 6.0 V	I <sub>R</sub>		0.02	10	μA
Capacitance	V <sub>R</sub> = 0 V	C <sub>O</sub>		14		pF
<b>OUTPUT</b>						
Collector emitter breakdown voltage	I <sub>CE</sub> = 100 μA	BV <sub>CEO</sub>	300			V
Emitter collector breakdown voltage	I <sub>EC</sub> = 100 μA	BV <sub>ECO</sub>	0.3			V
Collector emitter dark current	V <sub>CE</sub> = 200 V, T <sub>A</sub> = 25 °C	I <sub>CEO</sub>		10	200	nA
	V <sub>CE</sub> = 200 V, T <sub>A</sub> = 100 °C	I <sub>CEO</sub>			20	nA
Collector emitter capacitance	V <sub>CE</sub> = 0 V, f = 1.0 MHz	C <sub>CE</sub>		39		pF
<b>COUPLER</b>						
Collector emitter saturation voltage	I <sub>F</sub> = 1.0 mA, I <sub>C</sub> = 10 mA	V <sub>CEsat</sub>			1.0	V
	I <sub>F</sub> = 10 mA, I <sub>C</sub> = 100 mA	V <sub>CEsat</sub>	0.3		1.2	V
Coupling capacitance	V <sub>I-O</sub> = 0 V, f = 1.0 MHz	C <sub>C</sub>		0.6		pF

**Note**T<sub>amb</sub> = 25 °C, unless otherwise specified.

Minimum and maximum values are testing requirements. Typical values are characteristics of the device and are the result of engineering evaluation. Typical values are for information only and are not part of the testing requirements.

CURRENT TRANSFER RATIO						
PARAMETER	TEST CONDITION	SYMBOL	MIN.	TYP.	MAX.	UNIT
Coupling transfer ratio	I <sub>F</sub> = 1.0 mA, V <sub>CE</sub> = 1.0 V	CTR	1000			%

SWITCHING CHARACTERISTICS						
PARAMETER	TEST CONDITION	SYMBOL	MIN.	TYP.	MAX.	UNIT
Rise time	V <sub>CC</sub> = 10 V, I <sub>C</sub> = 10 mA, R <sub>L</sub> = 100 Ω	t <sub>r</sub>		3.5		μs
	V <sub>CC</sub> = 10 V, I <sub>F</sub> = 16 mA, R <sub>L</sub> = 180 Ω	t <sub>r</sub>		1.0		μs
Fall time	V <sub>CC</sub> = 10 V, I <sub>C</sub> = 10 mA, R <sub>L</sub> = 100 Ω	t <sub>f</sub>		14.5		μs
	V <sub>CC</sub> = 10 V, I <sub>F</sub> = 16 mA, R <sub>L</sub> = 180 Ω	t <sub>f</sub>		20.5		μs
Turn-on time	V <sub>CC</sub> = 10 V, I <sub>C</sub> = 10 mA, R <sub>L</sub> = 100 Ω	t <sub>on</sub>		4.5		μs
	V <sub>CC</sub> = 10 V, I <sub>F</sub> = 16 mA, R <sub>L</sub> = 180 Ω	t <sub>on</sub>		1.5		μs
Turn-off time	V <sub>CC</sub> = 10 V, I <sub>C</sub> = 10 mA, R <sub>L</sub> = 100 Ω	t <sub>off</sub>		29.0		μs
	V <sub>CC</sub> = 10 V, I <sub>F</sub> = 16 mA, R <sub>L</sub> = 180 Ω	t <sub>off</sub>		53.5		μs

SAFETY AND INSULATION RATINGS						
PARAMETER	TEST CONDITION	SYMBOL	MIN.	TYP.	MAX.	UNIT
Climatic classification (according to IEC 68 part 1)				55/100/21		
Comparative tracking index		CTI	175		399	
$V_{IOTM}$			10000			V
$V_{IORM}$			890			V
$P_{SO}$					400	mW
$I_{SI}$					275	mA
$T_{SI}$					175	°C
Creepage distance	standard DIP-4		7			mm
Clearance distance	standard DIP-4		7			mm
Creepage distance	400 mil DIP-4		8			mm
Clearance distance	400 mil DIP-4		8			mm
Insulation thickness, reinforced rated	per IEC 60950 2.10.5.1		0.4			mm

**Note**

As per IEC 60747-5-2, § 7.4.3.8.1, this optocoupler is suitable for "safe electrical insulation" only within the safety ratings. Compliance with the safety ratings shall be ensured by means of protective circuits.

**TYPICAL CHARACTERISTICS**

$T_{amb} = 25\text{ }^{\circ}\text{C}$ , unless otherwise specified

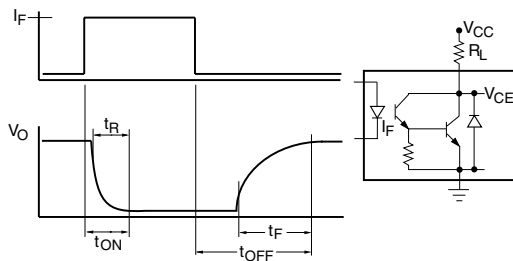

isfh619a\_01

Fig. 1 - Switching Waveform and Switching Schematic

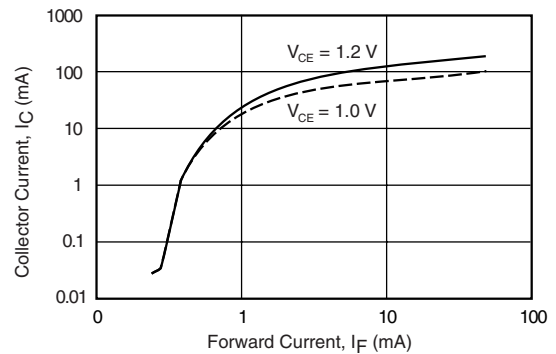

isfh619a\_03

Fig. 2 - Collector Current (mA) vs. Forward Current (mA)

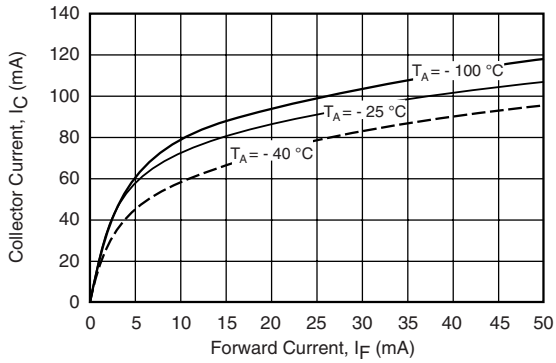

Fig. 3 - Collector Current vs. Forward Current

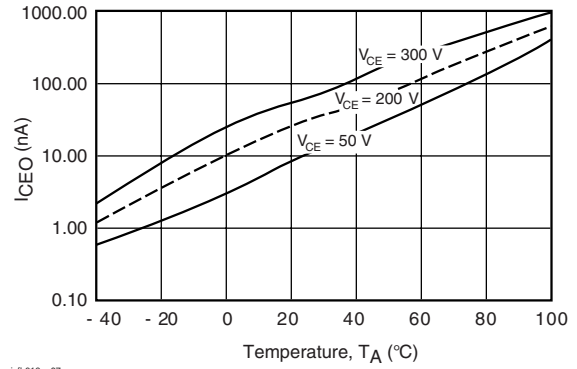

Fig. 6 - Collector Emitter Dark Current vs. Collector Emitter Voltage over Temperature

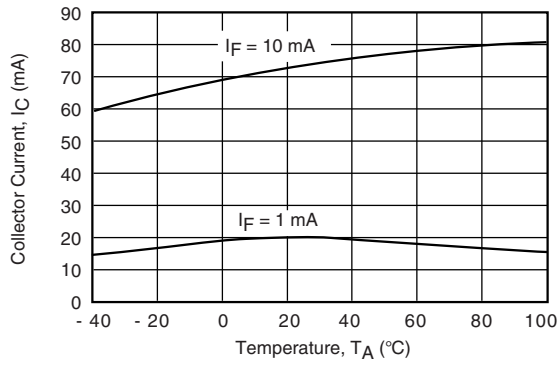

Fig. 4 - Collector Current vs. Ambient Temperature

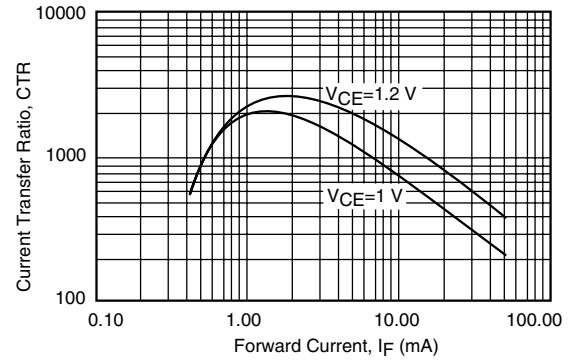

Fig. 7 - Current Transfer Ratio vs. Forward Current

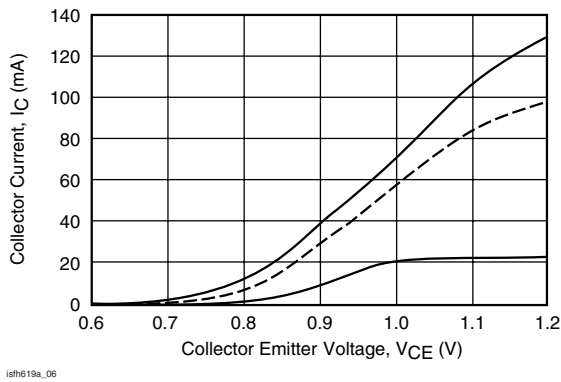

Fig. 5 - Collector Current vs. Collector Emitter Voltage

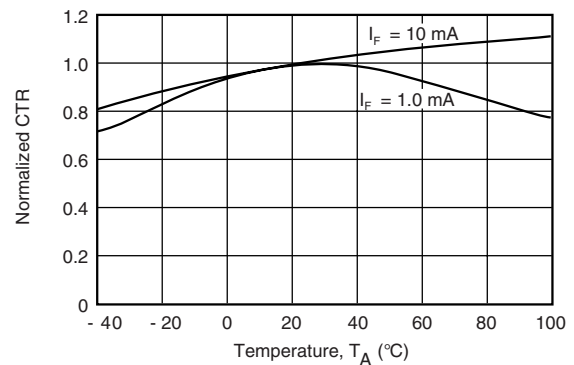
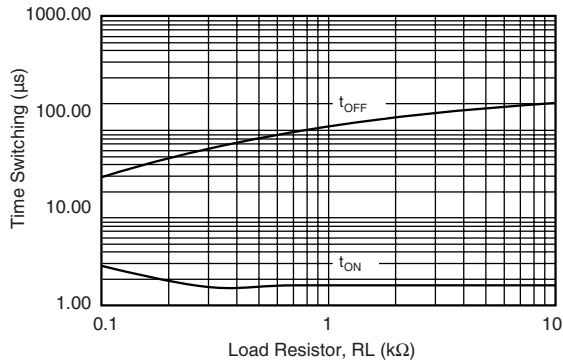

Fig. 8 - Normalized CTR vs. Temperature



sfh619a\_10

Fig. 9 - Switching Time vs. Load Resistor

### PACKAGE DIMENSIONS in inches (millimeters)

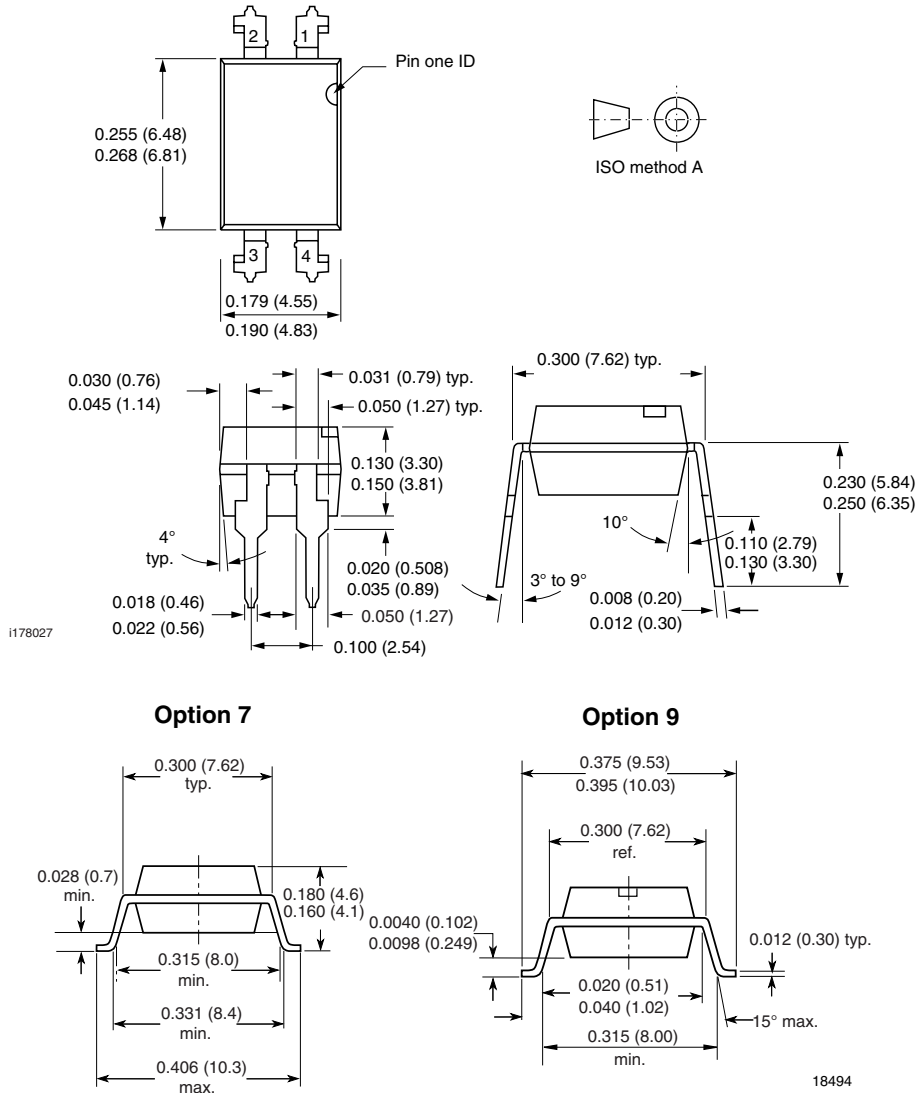

## **OZONE DEPLETING SUBSTANCES POLICY STATEMENT**

It is the policy of Vishay Semiconductor GmbH to

1. Meet all present and future national and international statutory requirements.
2. Regularly and continuously improve the performance of our products, processes, distribution and operating systems with respect to their impact on the health and safety of our employees and the public, as well as their impact on the environment.

It is particular concern to control or eliminate releases of those substances into the atmosphere which are known as ozone depleting substances (ODSs).

The Montreal Protocol (1987) and its London Amendments (1990) intend to severely restrict the use of ODSs and forbid their use within the next ten years. Various national and international initiatives are pressing for an earlier ban on these substances.

Vishay Semiconductor GmbH has been able to use its policy of continuous improvements to eliminate the use of ODSs listed in the following documents.

1. Annex A, B and list of transitional substances of the Montreal Protocol and the London Amendments respectively.
2. Class I and II ozone depleting substances in the Clean Air Act Amendments of 1990 by the Environmental Protection Agency (EPA) in the USA.
3. Council Decision 88/540/EEC and 91/690/EEC Annex A, B and C (transitional substances) respectively.

Vishay Semiconductor GmbH can certify that our semiconductors are not manufactured with ozone depleting substances and do not contain such substances.

We reserve the right to make changes to improve technical design  
and may do so without further notice.

Parameters can vary in different applications. All operating parameters must be validated for each customer application by the customer. Should the buyer use Vishay Semiconductors products for any unintended or unauthorized application, the buyer shall indemnify Vishay Semiconductors against all claims, costs, damages, and expenses, arising out of, directly or indirectly, any claim of personal damage, injury or death associated with such unintended or unauthorized use.

Vishay Semiconductor GmbH, P.O.B. 3535, D-74025 Heilbronn, Germany



## Notice

Specifications of the products displayed herein are subject to change without notice. Vishay Intertechnology, Inc., or anyone on its behalf, assumes no responsibility or liability for any errors or inaccuracies.

Information contained herein is intended to provide a product description only. No license, express or implied, by estoppel or otherwise, to any intellectual property rights is granted by this document. Except as provided in Vishay's terms and conditions of sale for such products, Vishay assumes no liability whatsoever, and disclaims any express or implied warranty, relating to sale and/or use of Vishay products including liability or warranties relating to fitness for a particular purpose, merchantability, or infringement of any patent, copyright, or other intellectual property right.

The products shown herein are not designed for use in medical, life-saving, or life-sustaining applications. Customers using or selling these products for use in such applications do so at their own risk and agree to fully indemnify Vishay for any damages resulting from such improper use or sale.