

NDF10N60ZH

Product Preview

N-Channel Power MOSFET 600 V, 0.75 Ω

Features

- Low ON Resistance
- Low Gate Charge
- Zener Diode-protected Gate
- 100% Avalanche Tested
- These Devices are Pb-Free, Halogen Free/BFR Free and are RoHS Compliant

ABSOLUTE MAXIMUM RATINGS ($T_C = 25^\circ\text{C}$ unless otherwise noted)

Rating	Symbol	Typ	Unit
Drain-to-Source Voltage	V_{DSS}	600	V
Continuous Drain Current, $R_{\theta JC}$	I_D	10 (Note 2)	A
Continuous Drain Current $T_A = 100^\circ\text{C}$, $R_{\theta JC}$	I_D	5.7 (Note 2)	A
Pulsed Drain Current, $V_{GS} @ 10\text{ V}$	I_{DM}	36 (Note 2)	A
Power Dissipation, $R_{\theta JC}$ (Note 1)	P_D	36	W
Gate-to-Source Voltage	V_{GS}	± 30	V
Single Pulse Avalanche Energy, $L = 6.0\text{ mH}$, $I_D = 10\text{ A}$	E_{AS}	300	mJ
ESD (HBM) (JESD22-A114)	V_{esd}	3900	V
RMS Isolation Voltage ($t = 0.3\text{ sec.}$, R.H. $\leq 30\%$, $T_A = 25^\circ\text{C}$) (Figure 14)	V_{ISO}	4500	V
Peak Diode Recovery	dv/dt	4.5 (Note 3)	V/ns
Continuous Source Current (Body Diode)	I_S	10	A
Maximum Temperature for Soldering Leads	T_L	260	$^\circ\text{C}$
Operating Junction and Storage Temperature Range	T_J, T_{stg}	-55 to 150	$^\circ\text{C}$

Stresses exceeding Maximum Ratings may damage the device. Maximum Ratings are stress ratings only. Functional operation above the Recommended Operating Conditions is not implied. Extended exposure to stresses above the Recommended Operating Conditions may affect device reliability.

1. Surface mounted on FR4 board using 1 in sq. pad size, 1 oz cu
2. Limited by maximum junction temperature
3. $I_S \leq 10\text{ A}$, $di/dt \leq 200\text{ A}/\mu\text{s}$, $V_{DD} = 80\% BV_{DSS}$

This document contains information on a product under development. ON Semiconductor reserves the right to change or discontinue this product without notice.



ON Semiconductor®

<http://onsemi.com>

V_{DSS}	$R_{DS(ON)}$ (MAX) @ 5 A
600 V	0.75 Ω

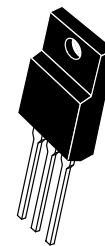

TO-220FP
CASE 221AH
STYLE 1

MARKING DIAGRAM

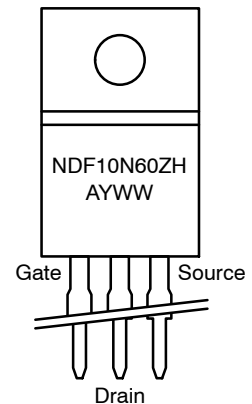

- A = Location Code
- Y = Year
- WW = Work Week
- H = Halogen Free Package

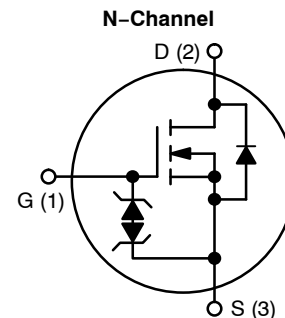

ORDERING INFORMATION

Device	Package	Shipping
NDF10N60ZH	TO-220FP	50 Units / Rail (In Development)

NDF10N60ZH

THERMAL RESISTANCE

Parameter	Symbol	Typ	Unit
Junction-to-Case (Drain)	$R_{\theta JC}$	3.4	°C/W
Junction-to-Ambient Steady State (Note 4)	$R_{\theta JA}$	50	

ELECTRICAL CHARACTERISTICS ($T_J = 25^\circ\text{C}$ unless otherwise noted)

Characteristic	Test Conditions	Symbol	Min	Typ	Max	Unit
----------------	-----------------	--------	-----	-----	-----	------

OFF CHARACTERISTICS

Drain-to-Source Breakdown Voltage	$V_{GS} = 0\text{ V}, I_D = 1\text{ mA}$	BV_{DSS}	600			V
Breakdown Voltage Temperature Coefficient	Reference to 25°C , $I_D = 1\text{ mA}$	$\Delta BV_{DSS}/\Delta T_J$		0.6		V/°C
Drain-to-Source Leakage Current	$V_{DS} = 600\text{ V}, V_{GS} = 0\text{ V}$	I_{DSS}			1	μA
					50	
Gate-to-Source Forward Leakage	$V_{GS} = \pm 20\text{ V}$	I_{GSS}			± 10	μA

ON CHARACTERISTICS (Note 5)

Static Drain-to-Source On-Resistance	$V_{GS} = 10\text{ V}, I_D = 5.0\text{ A}$	$R_{DS(on)}$		0.65	0.75	Ω
Gate Threshold Voltage	$V_{DS} = V_{GS}, I_D = 100\ \mu\text{A}$	$V_{GS(th)}$	3.0		4.5	V
Forward Transconductance	$V_{DS} = 15\text{ V}, I_D = 10\text{ A}$	g_{FS}		7.9		S

DYNAMIC CHARACTERISTICS

Input Capacitance	$V_{DS} = 25\text{ V}, V_{GS} = 0\text{ V},$ $f = 1.0\text{ MHz}$	C_{iss}		1425		μF
Output Capacitance		C_{oss}		150		
Reverse Transfer Capacitance		C_{rss}		35		
Total Gate Charge	$V_{DD} = 300\text{ V}, I_D = 10\text{ A},$ $V_{GS} = 10\text{ V}$	Q_g		47		nC
Gate-to-Source Charge		Q_{gs}		9.0		
Gate-to-Drain ("Miller") Charge		Q_{gd}		26		
Plateau Voltage		V_{GP}		6.3		
Gate Resistance		R_g		1.5		Ω

RESISTIVE SWITCHING CHARACTERISTICS

Turn-On Delay Time	$V_{DD} = 300\text{ V}, I_D = 10\text{ A},$ $V_{GS} = 10\text{ V}, R_G = 5\ \Omega$	$t_{d(on)}$		15		ns
Rise Time		t_r		31		
Turn-Off Delay Time		$t_{d(off)}$		40		
Fall Time		t_f		23		

SOURCE-DRAIN DIODE CHARACTERISTICS ($T_C = 25^\circ\text{C}$ unless otherwise noted)

Diode Forward Voltage	$I_S = 10\text{ A}, V_{GS} = 0\text{ V}$	V_{SD}			1.6	V
Reverse Recovery Time	$V_{GS} = 0\text{ V}, V_{DD} = 30\text{ V}$ $I_S = 10\text{ A}, di/dt = 100\text{ A}/\mu\text{s}$	t_{rr}		395		ns
Reverse Recovery Charge		Q_{rr}		3.0		μC

4. Insertion mounted

5. Pulse Width $\leq 380\ \mu\text{s}$, Duty Cycle $\leq 2\%$.

NDF10N60ZH

TYPICAL CHARACTERISTICS

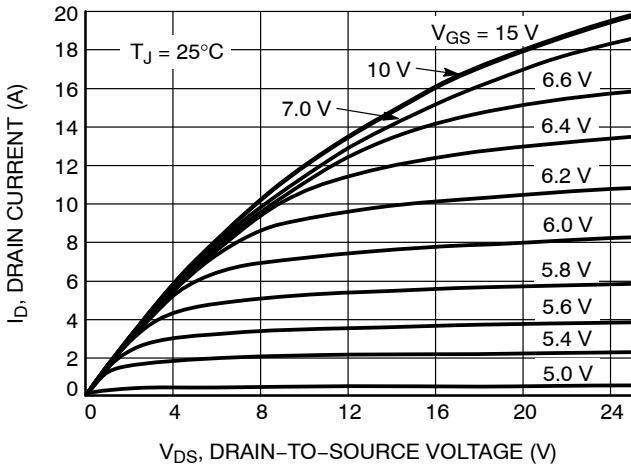

Figure 1. On-Region Characteristics

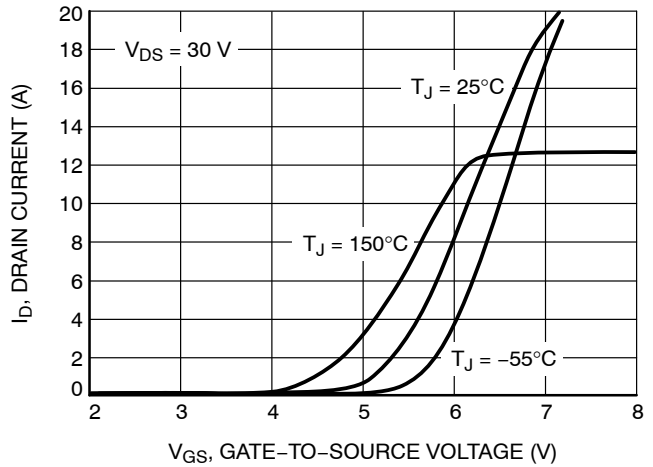

Figure 2. Transfer Characteristics

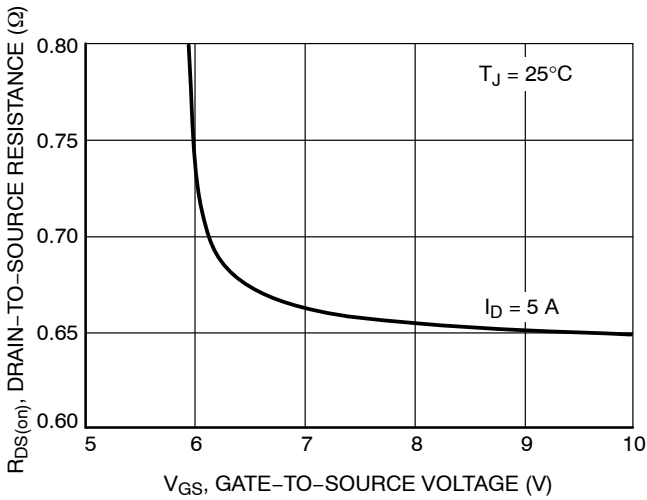

Figure 3. On-Resistance vs. Gate Voltage

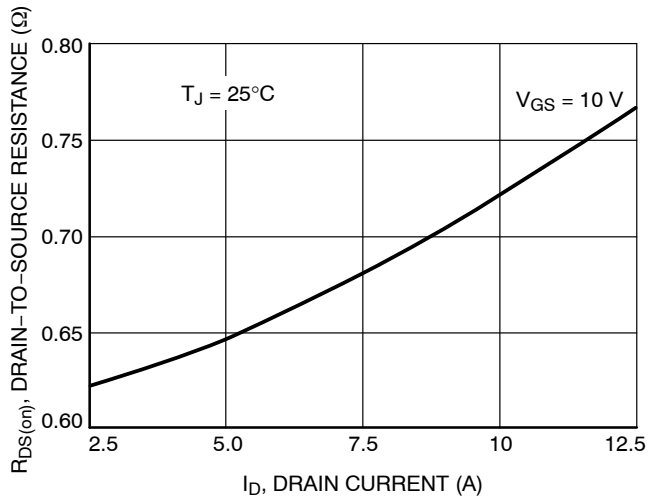

Figure 4. On-Resistance vs. Drain Current and Gate Voltage

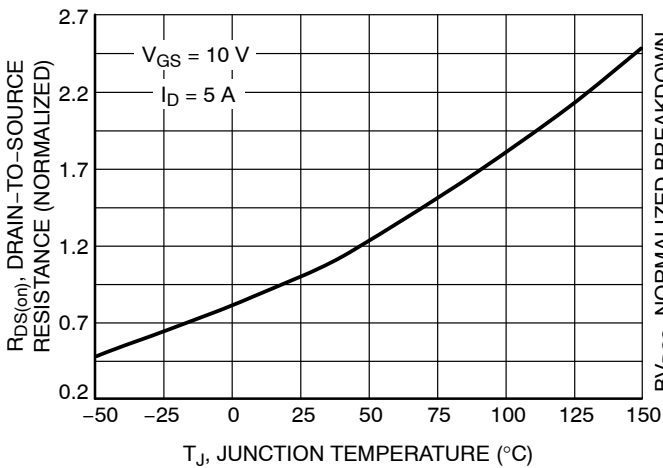

Figure 5. On-Resistance Variation with Temperature

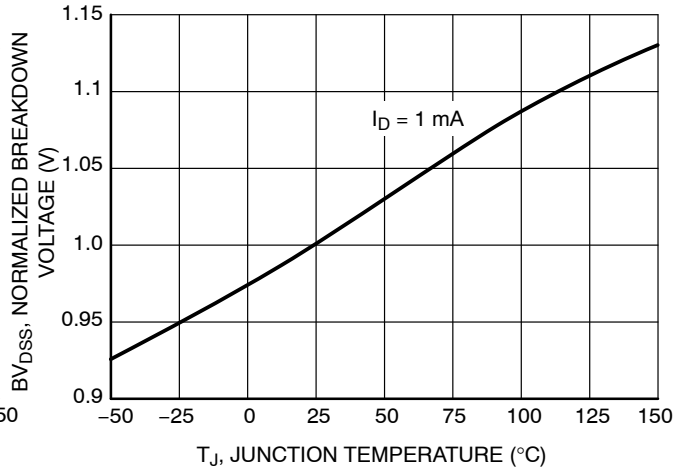

Figure 6. BV_{DSS} Variation with Temperature

NDF10N60ZH

TYPICAL CHARACTERISTICS

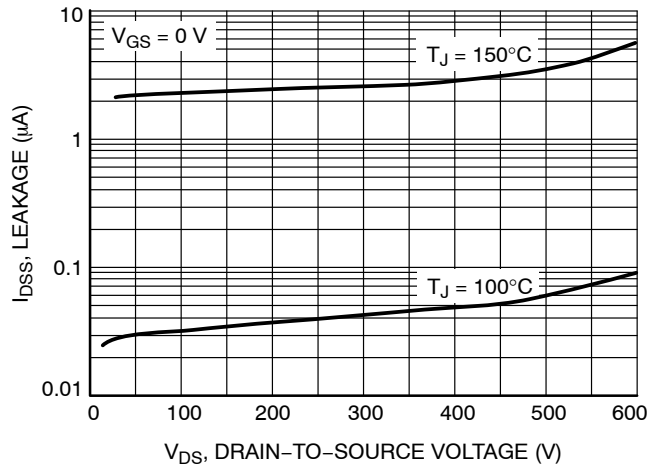

Figure 7. Drain-to-Source Leakage Current vs. Voltage

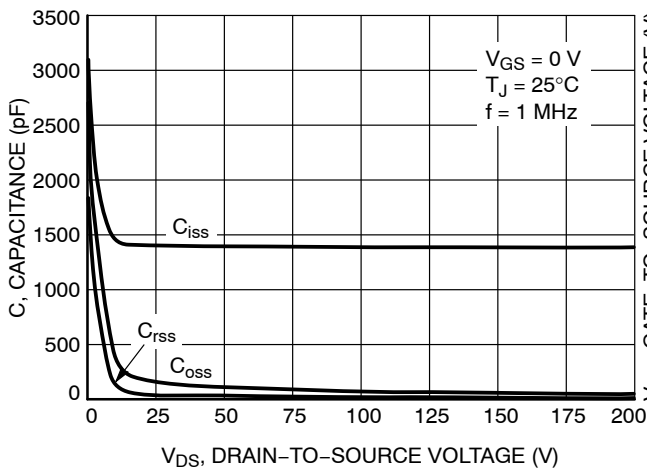

Figure 8. Capacitance Variation

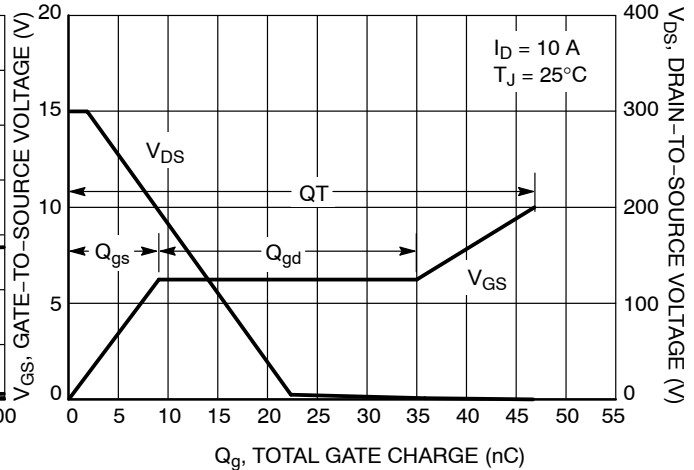

Figure 9. Gate-to-Source and Drain-to-Source Voltage vs. Total Charge

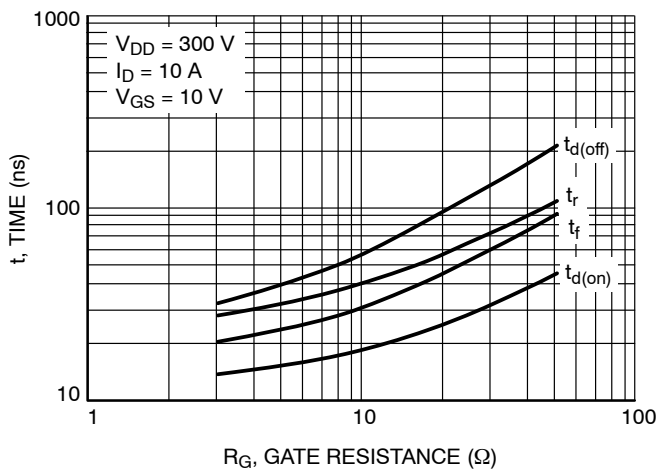

Figure 10. Resistive Switching Time Variation vs. Gate Resistance

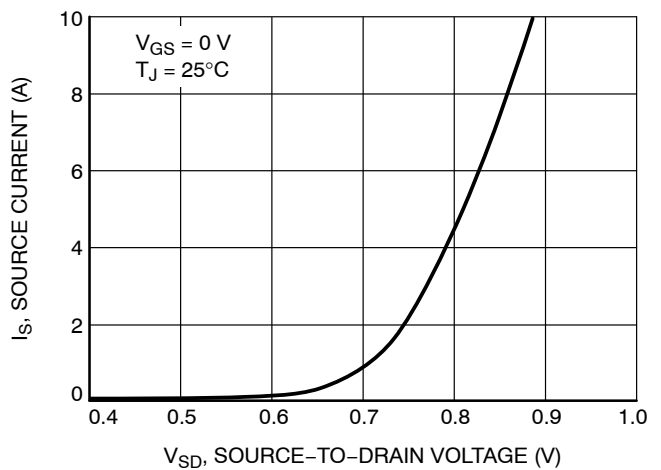
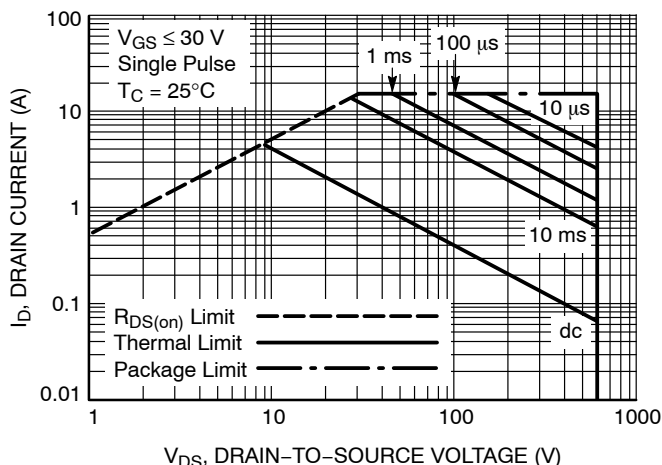

Figure 11. Diode Source Current vs. Forward Voltage

NDF10N60ZH

TYPICAL CHARACTERISTICS



Mounted on 2" sq. FR4 board (1" sq. 2 oz. Cu 0.06" thick single sided) with one die operating

Figure 12. Maximum Rated Forward Biased Safe Operating Area

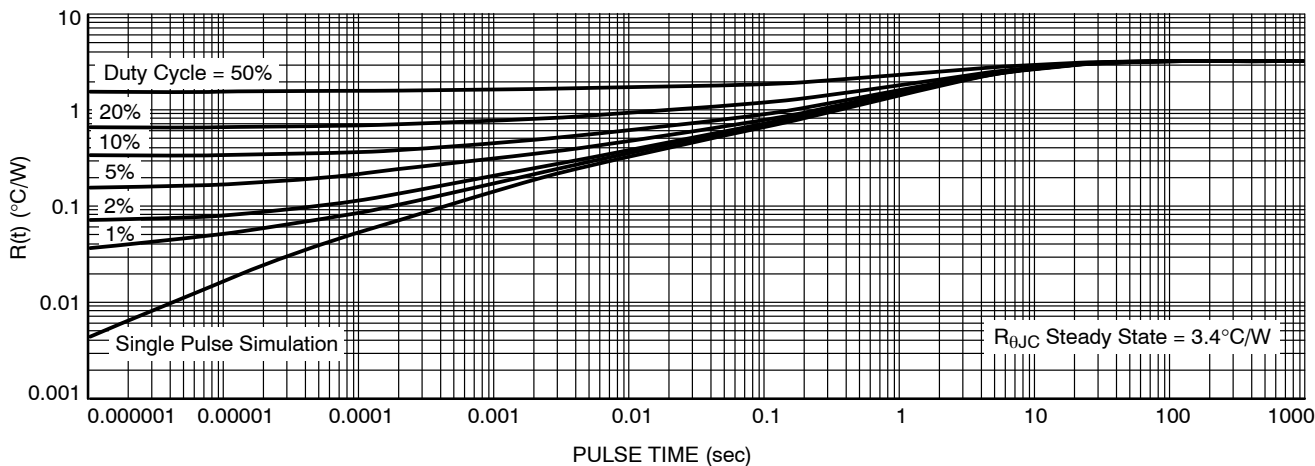

Figure 13. Thermal Impedance (Junction-to-Case)

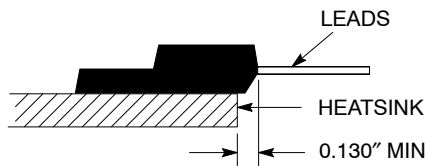

Figure 14. Mounting Position for Isolation Test

Measurement made between leads and heatsink with all leads shorted together.

*For additional mounting information, please download the ON Semiconductor Soldering and Mounting Techniques Reference Manual, SOLDERRM/D.

NDF10N60ZH

PACKAGE DIMENSIONS

TO-220 FULLPACK, 3-LEAD
CASE 221AH-01
ISSUE O

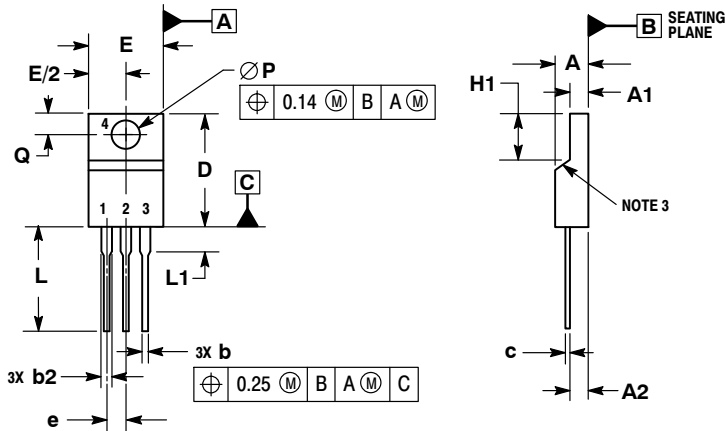

NOTES:

1. DIMENSIONING AND TOLERANCING PER ASME Y14.5M, 1994.
2. CONTROLLING DIMENSION: MILLIMETERS.
3. CONTOUR UNCONTROLLED IN THIS AREA.
4. DIMENSIONS D AND E DO NOT INCLUDE MOLD FLASH AND GATE PROTRUSIONS. MOLD FLASH AND GATE PROTRUSIONS NOT TO EXCEED 0.13 PER SIDE. THESE DIMENSIONS ARE TO BE MEASURED AT OUTERMOST EXTREME OF THE PLASTIC BODY.
5. DIMENSION b2 DOES NOT INCLUDE DAMBAR PROTRUSION. LEAD WIDTH INCLUDING PROTRUSION SHALL NOT EXCEED 2.00.

DIM	MILLIMETERS	
	MIN	MAX
A	4.30	4.70
A1	2.50	2.90
A2	2.50	2.70
b	0.54	0.84
b2	1.10	1.40
c	0.49	0.79
D	14.22	15.88
E	9.65	10.67
e	2.54 BSC	
H1	5.97	6.48
L	12.70	14.73
L1	---	2.80
P	3.00	3.40
Q	2.80	3.20

ON Semiconductor and are registered trademarks of Semiconductor Components Industries, LLC (SCILLC). SCILLC reserves the right to make changes without further notice to any products herein. SCILLC makes no warranty, representation or guarantee regarding the suitability of its products for any particular purpose, nor does SCILLC assume any liability arising out of the application or use of any product or circuit, and specifically disclaims any and all liability, including without limitation special, consequential or incidental damages. "Typical" parameters which may be provided in SCILLC data sheets and/or specifications can and do vary in different applications and actual performance may vary over time. All operating parameters, including "Typicals" must be validated for each customer application by customer's technical experts. SCILLC does not convey any license under its patent rights nor the rights of others. SCILLC products are not designed, intended, or authorized for use as components in systems intended for surgical implant into the body, or other applications intended to support or sustain life, or for any other application in which the failure of the SCILLC product could create a situation where personal injury or death may occur. Should Buyer purchase or use SCILLC products for any such unintended or unauthorized application, Buyer shall indemnify and hold SCILLC and its officers, employees, subsidiaries, affiliates, and distributors harmless against all claims, costs, damages, and expenses, and reasonable attorney fees arising out of, directly or indirectly, any claim of personal injury or death associated with such unintended or unauthorized use, even if such claim alleges that SCILLC was negligent regarding the design or manufacture of the part. SCILLC is an Equal Opportunity/Affirmative Action Employer. This literature is subject to all applicable copyright laws and is not for resale in any manner.

PUBLICATION ORDERING INFORMATION

LITERATURE FULFILLMENT:
Literature Distribution Center for ON Semiconductor
P.O. Box 5163, Denver, Colorado 80217 USA
Phone: 303-675-2175 or 800-344-3860 Toll Free USA/Canada
Fax: 303-675-2176 or 800-344-3867 Toll Free USA/Canada
Email: orderlit@onsemi.com

N. American Technical Support: 800-282-9855 Toll Free
USA/Canada
Europe, Middle East and Africa Technical Support:
Phone: 421 33 790 2910
Japan Customer Focus Center
Phone: 81-3-5773-3850

ON Semiconductor Website: www.onsemi.com
Order Literature: <http://www.onsemi.com/orderlit>
For additional information, please contact your local Sales Representative

NDF10N60ZH/D