

4-Mbit (512K x 8) MoBL[®] Static RAM

Features

- Temperature Ranges
 - Industrial: -40°C to 85°C
 - Automotive-A: -40°C to 85°C
- Very high speed: 55 ns
 - Wide voltage range: 2.20V – 3.60V
- Pin-compatible with CY62148CV25, CY62148CV30 and CY62148CV33
- Ultra low active power
 - Typical active current: 1.5 mA @ f = 1 MHz
 - Typical active current: 8 mA @ f = f_{max}(55-ns speed)
- Ultra low standby power
- Easy memory expansion with \overline{CE} , and \overline{OE} features
- Automatic power-down when deselected
- CMOS for optimum speed/power
- Available in Pb-free and non Pb-free 36-ball VFBGA, Pb-free 32-pin TSOPII and 32-pin SOIC packages

Functional Description^[1]

The CY62148DV30 is a high-performance CMOS static RAM organized as 512K words by 8 bits. This device features advanced circuit design to provide ultra-low active current. This is ideal for providing More Battery Life™ (MoBL[®]) in portable applications such as cellular telephones. The device also has an automatic power-down feature that significantly reduces power consumption. The device can be put into standby mode reducing power consumption when deselected (\overline{CE} HIGH). The eight input and output pins (IO₀ through IO₇) are placed in a high-impedance state when:

- Deselected (\overline{CE} HIGH)
- Outputs are disabled (\overline{OE} HIGH)
- When the write operation is active (\overline{CE} LOW and \overline{WE} LOW)

Write to the device by taking Chip Enable (\overline{CE}) and Write Enable (\overline{WE}) inputs LOW. Data on the eight IO pins (IO₀ through IO₇) is then written into the location specified on the address pins (A₀ through A₁₈).

Read from the device by taking Chip Enable (\overline{CE}) and Output Enable (\overline{OE}) LOW while forcing Write Enable (\overline{WE}) HIGH. Under these conditions, the contents of the memory location specified by the address pins will appear on the IO pins.

Logic Block Diagram

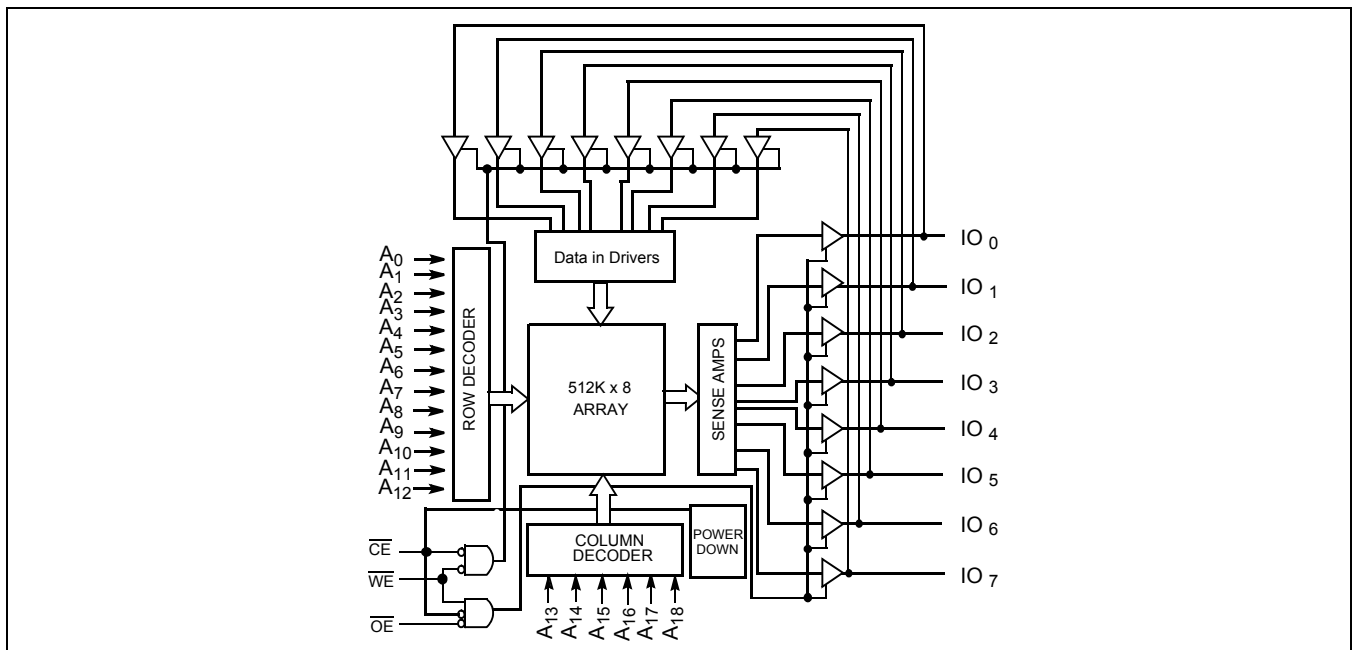

Note:

1. For best practice recommendations, refer to the Cypress application note "System Design Guidelines" on <http://www.cypress.com>.

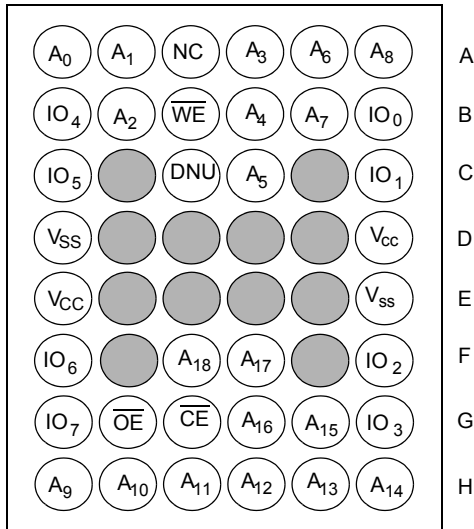
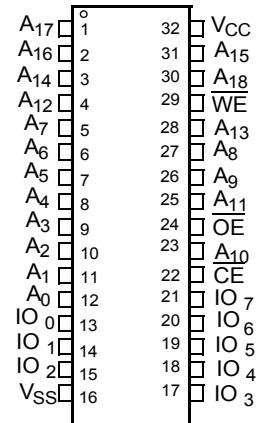
Pin Configuration^[2, 3]
36-ball VFBGA Pinout
Top View

32-pin SOIC / TSOP II Pinout
Top View

Product Portfolio

Product	Range	V _{CC} Range (V)			Speed (ns)	Power Dissipation					
						Operating I _{CC} (mA)				Standby I _{SB2} (μA)	
		Min	Typ ^[4]	Max		f = 1 MHz		f = f _{max}			
						Typ ^[4]	Max	Typ ^[4]	Max	Typ ^[4]	Max
CY62148DV30L	Industrial	2.2	3.0	3.6	55	1.5	3	8	15	2	12
CY62148DV30LL	Industrial					1.5	3	8	10	2	8
CY62148DV30LL	Industrial					1.5	3	8	10	2	8
CY62148DV30LL	Automotive-A					1.5	3	8	10	2	8

Notes:

- NC pins are not connected on the die.
- DNU pins have to be left floating or tied to V_{SS} to ensure proper application.
- Typical values are included for reference only and are not guaranteed or tested. Typical values are measured at V_{CC} = V_{CC(typ)}, T_A = 25°C.

Maximum Ratings

(Exceeding maximum ratings may impair the useful life of the device. For user guidelines, not tested.)

Storage Temperature	-65°C to +150°C
Ambient Temperature with Power Applied	55°C to +125°C
Supply Voltage to Ground Potential	-0.3V to $V_{CC(max)} + 0.3V$
DC Voltage Applied to Outputs in High-Z State ^[5, 6]	-0.3V to $V_{CC(max)} + 0.3V$
DC Input Voltage ^[5, 6]	-0.3V to $V_{CC(max)} + 0.3V$

Output Current into Outputs (LOW)	20 mA
Static Discharge Voltage	> 2001V (per MIL-STD-883, Method 3015)
Latch-up Current	> 200 mA

Operating Range

Product	Range	Ambient Temperature	$V_{CC}^{[7]}$
CY62148DV30L	Industrial	-40°C to +85°C	2.2V to 3.6V
CY62148DV30LL			
CY62148DV30LL	Automotive-A	-40°C to +85°C	

Electrical Characteristics Over the Operating Range

Parameter	Description	Test Conditions		55 ns			70 ns			Unit	
				Min	Typ ^[4]	Max	Min	Typ ^[4]	Max		
V _{OH}	Output HIGH Voltage	I _{OH} = -0.1 mA	V _{CC} = 2.20V	2.0			2.0			V	
		I _{OH} = -1.0 mA	V _{CC} = 2.70V	2.4			2.4			V	
V _{OL}	Output LOW Voltage	I _{OL} = 0.1 mA	V _{CC} = 2.20V			0.4			0.4	V	
		I _{OL} = 2.1 mA	V _{CC} = 2.70V			0.4			0.4	V	
V _{IH}	Input HIGH Voltage	V _{CC} = 2.2V to 2.7V		1.8		V _{CC} +0.3V	1.8		V _{CC} +0.3V	V	
		V _{CC} = 2.7V to 3.6V		2.2		V _{CC} +0.3V	2.2		V _{CC} +0.3V	V	
V _{IL}	Input LOW Voltage	V _{CC} = 2.2V to 2.7V		-0.3		0.6	-0.3		0.6	V	
		V _{CC} = 2.7V to 3.6V		-0.3		0.8	-0.3		0.8	V	
I _{IX}	Input Leakage Current	GND ≤ V _I ≤ V _{CC}		-1		+1	-1		+1	μA	
I _{OZ}	Output Leakage Current	GND ≤ V _O ≤ V _{CC} , Output Disabled		-1		+1	-1		+1	μA	
I _{CC}	V _{CC} Operating Supply Current	f = f _{max} = 1/t _{RC}	V _{CC} = V _{CC(max)} I _{OUT} = 0 mA CMOS levels	Ind'l	L	8	15				mA
				Ind'l	LL	8	10		8	10	mA
				Auto-A	LL				8	10	mA
		f = 1 MHz	Ind'l	L	1.5	3				mA	
			Ind'l	LL	1.5	3		1.5	3	mA	
			Auto-A	LL				1.5	3	mA	
I _{SB1}	Automatic CE Power-down Current — CMOS Inputs	CE ≥ V _{CC} -0.2V, V _{IN} ≥ V _{CC} -0.2V, V _{IN} ≤ 0.2V f = f _{max} (Address and Data Only), f = 0 (OE, and WE), V _{CC} = 3.60V		Ind'l	L	2	12				μA
				Ind'l	LL	2	8		2	8	
				Auto-A	LL				2	8	
I _{SB2}	Automatic CE Power-down Current — CMOS Inputs	CE ≥ V _{CC} - 0.2V, V _{IN} ≥ V _{CC} - 0.2V or V _{IN} ≤ 0.2V, f = 0, V _{CC} = 3.60V		Ind'l	L	2	12				μA
				Ind'l	LL	2	8		2	8	
				Auto-A	LL				2	8	

Notes:

- V_{IL(min)} = -2.0V for pulse durations less than 20 ns.
- V_{IH(max)} = V_{CC}+0.75V for pulse durations less than 20 ns.
- Full device AC operation assumes a 100 μs ramp time from 0 to V_{CC(min)} and 200 μs wait time after V_{CC} stabilization.

Capacitance (for all packages)^[8]

Parameter	Description	Test Conditions	Max	Unit
C _{IN}	Input Capacitance	T _A = 25°C, f = 1 MHz, V _{CC} = V _{CC(typ)}	10	pF
C _{OUT}	Output Capacitance		10	pF

Thermal Resistance

Parameter	Description	Test Conditions	VFBGA	TSOP II	SOIC	Unit
θ _{JA}	Thermal Resistance (Junction to Ambient)	Still Air, soldered on a 3 x 4.5 inch, four-layer printed circuit board	72	75.13	55	°C/W
θ _{JC}	Thermal Resistance (Junction to Case)		8.86	8.95	22	°C/W

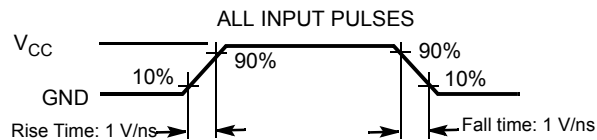
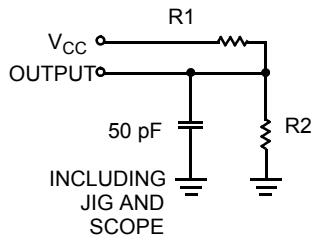
AC Test Loads and Waveforms

Equivalent to: THÉVENIN EQUIVALENT

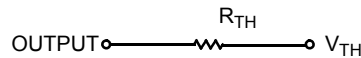

Parameters	2.5V (2.2V – 2.7V)	3.0V (2.7V – 3.6V)	Unit
R1	16667	1103	Ω
R2	15385	1554	Ω
R _{TH}	8000	645	Ω
V _{TH}	1.20	1.75	V

Data Retention Characteristics (Over the Operating Range)

Parameter	Description	Conditions	Min	Typ ^[4]	Max	Unit
V _{DR}	V _{CC} for Data Retention		1.5			V
I _{CCDR}	Data Retention Current	V _{CC} = 1.5V, $\overline{CE} \geq V_{CC} - 0.2V$, V _{IN} ≥ V _{CC} - 0.2V or V _{IN} ≤ 0.2V			9	μA
			Ind'I / Auto-A / LL			6
t _{CDR} ^[8]	Chip Deselect to Data Retention Time		0			ns
t _R ^[9]	Operation Recovery Time		t _{RC}			ns

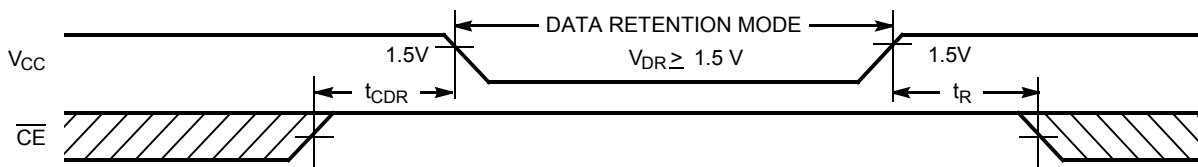
Data Retention Waveform

Notes:

8. Tested initially and after any design or process changes that may affect these parameters.
9. Full Device AC operation requires linear V_{CC} ramp from V_{DR} to V_{CC(min)} ≥ 100 μs or stable at V_{CC(min)} ≥ 100 μs.

Switching Characteristics (Over the Operating Range)^[10]

Parameter	Description	55 ns		70 ns		Unit
		Min	Max	Min	Max	
Read Cycle						
t _{RC}	Read Cycle Time	55		70		ns
t _{AA}	Address to Data Valid		55		70	ns
t _{OHA}	Data Hold from Address Change	10		10		ns
t _{ACE}	\overline{CE} LOW to Data Valid		55		70	ns
t _{DOE}	\overline{OE} LOW to Data Valid		25		35	ns
t _{LZOE}	\overline{OE} LOW to Low Z ^[11]	5		5		ns
t _{HZOE}	\overline{OE} HIGH to High Z ^[11,12]		20		25	ns
t _{LZCE}	\overline{CE} LOW to Low Z ^[11]	10		10		ns
t _{HZCE}	\overline{CE} HIGH to High Z ^[11, 12]		20		25	ns
t _{PU}	\overline{CE} LOW to Power-up	0		0		ns
t _{PD}	\overline{CE} HIGH to Power-up		55		70	ns
Write Cycle^[13]						
t _{WC}	Write Cycle Time	55		70		ns
t _{SCE}	\overline{CE} LOW to Write End	40		45		ns
t _{AW}	Address Set-up to Write End	40		45		ns
t _{HA}	Address Hold from Write End	0		0		ns
t _{SA}	Address Set-up to Write Start	0		0		ns
t _{PWE}	\overline{WE} Pulse Width	40		45		ns
t _{SD}	Data Set-up to Write End	25		30		ns
t _{HD}	Data Hold from Write End	0		0		ns
t _{HZWE}	\overline{WE} LOW to High Z ^[11, 12]		20		25	ns
t _{LZWE}	\overline{WE} HIGH to Low Z ^[11]	10		10		ns

Switching Waveforms

Read Cycle No. 1 (Address Transition Controlled)^[14, 15]

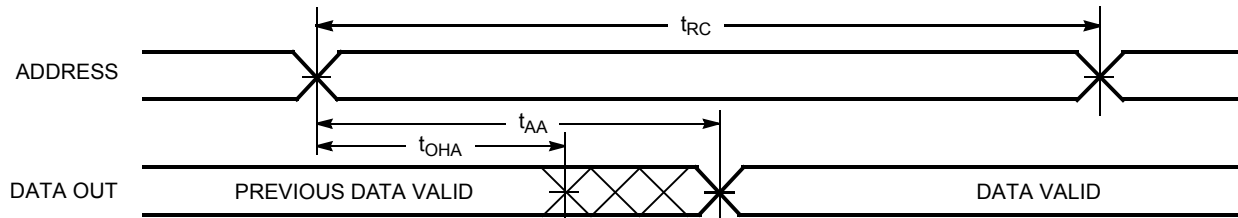

Notes:

10. Test Conditions for all parameters other than three-state parameters assume signal transition time of 3 ns or less (1 V/ns), timing reference levels of $V_{CC(typ)}/2$, input pulse levels of 0 to $V_{CC(typ)}$, and output loading of the specified I_{OL}/I_{OH} as shown in the "AC Test Loads and Waveforms" on page 4.
11. At any given temperature and voltage condition, t_{HZCE} is less than t_{LZCE}, t_{HZOE} is less than t_{LZOE}, and t_{HZWE} is less than t_{LZWE} for any given device.
12. t_{HZOE}, t_{HZCE}, and t_{HZWE} transitions are measured when the output enter a high impedance state.
13. The internal write time of the memory is defined by the overlap of \overline{WE} , $\overline{CE} = V_{IL}$. All signals must be ACTIVE to initiate a write and any of these signals can terminate a write by going INACTIVE. The data input set-up and hold timing should be referenced to the edge of the signal that terminates the write.
14. Device is continuously selected. \overline{OE} , $\overline{CE} = V_{IL}$.
15. \overline{WE} is HIGH for read cycle.

Switching Waveforms (continued)

Read Cycle No. 2 (\overline{OE} Controlled)^[15, 16]

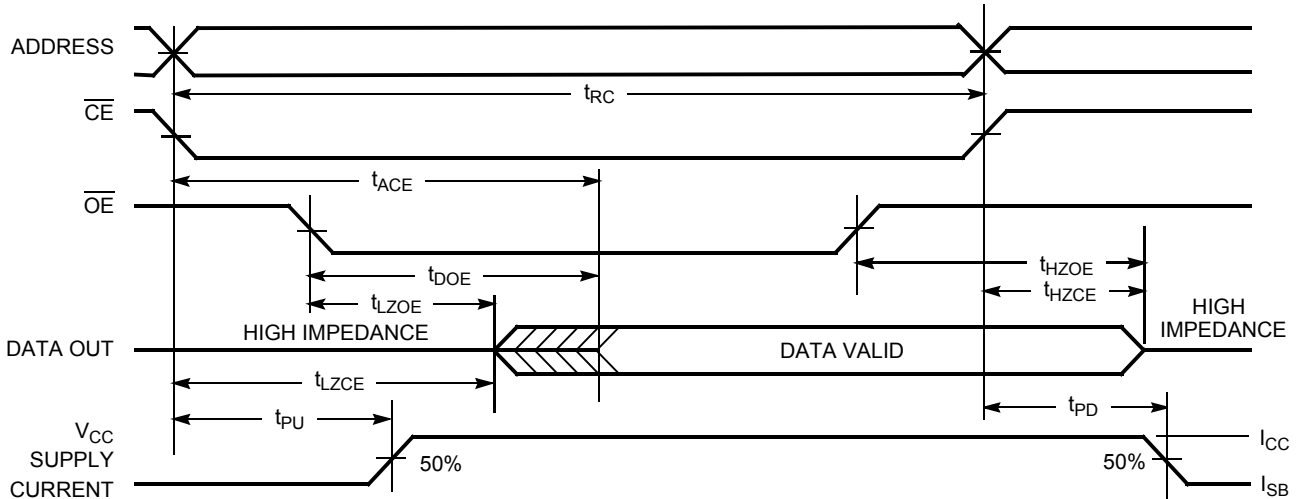

Write Cycle No. 1 (\overline{WE} Controlled)^[17, 18]

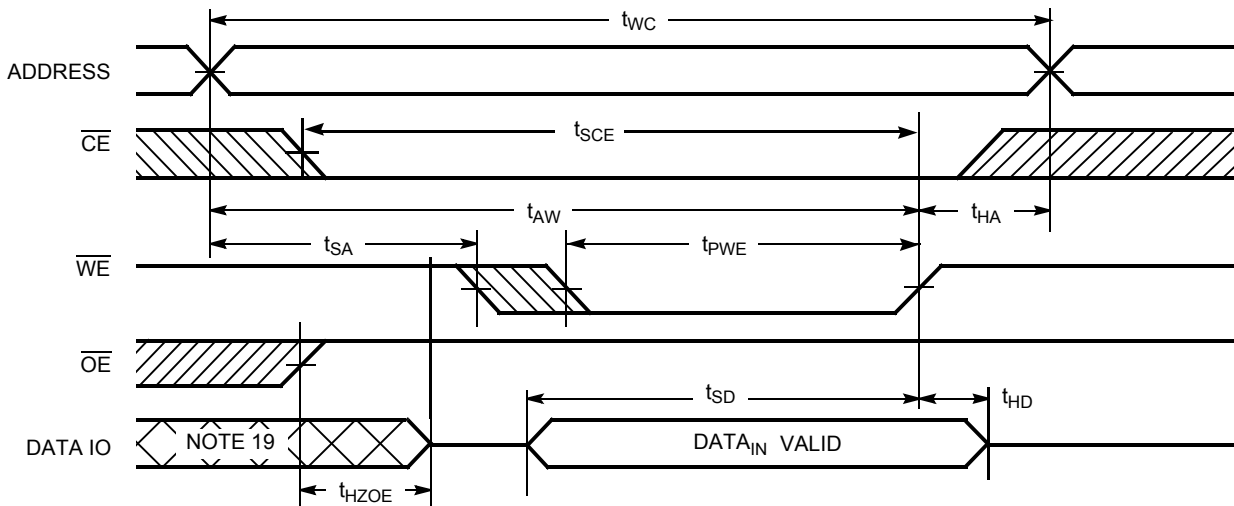

Notes:

- 16. Address valid prior to or coincident with \overline{CE} transition LOW.
- 17. Data IO is high impedance if $\overline{OE} = V_{IH}$.
- 18. If \overline{CE} goes HIGH simultaneously with \overline{WE} HIGH, the output remains in high-impedance state.
- 19. During this period, the IOs are in output state and input signals should not be applied.

Switching Waveforms (continued)

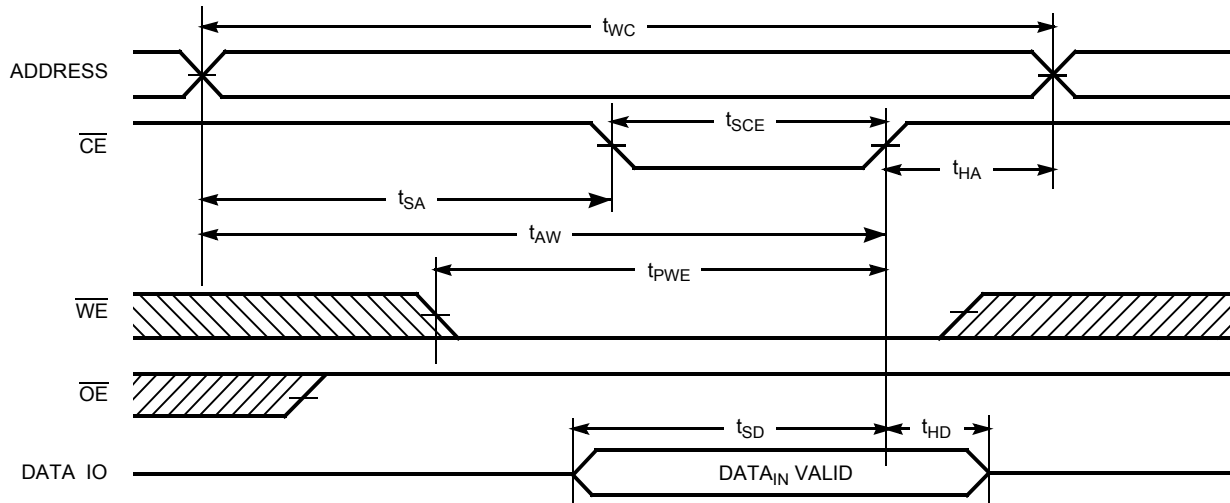
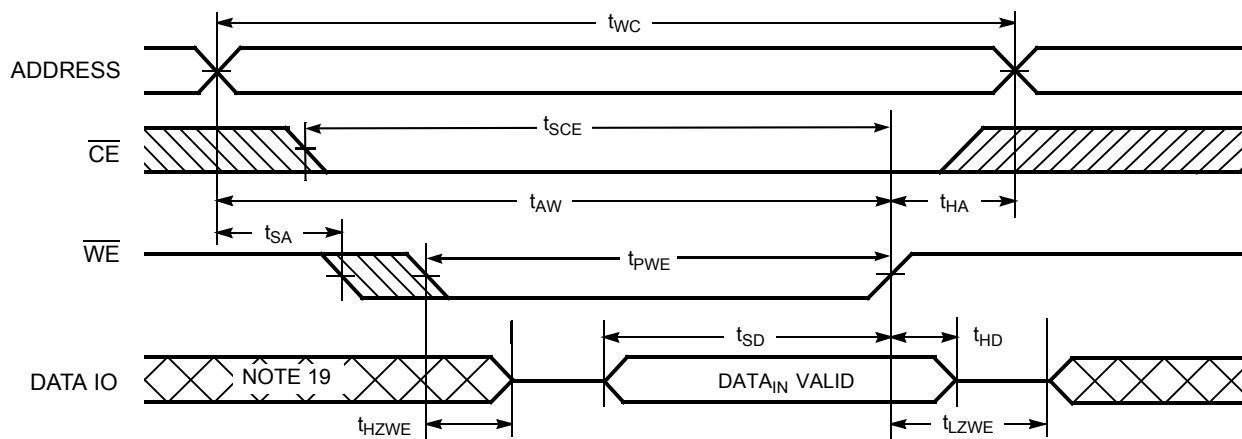
Write Cycle No. 2 ($\overline{\text{CE}}$ Controlled)^[17, 18]

Write Cycle No. 3 ($\overline{\text{WE}}$ Controlled, $\overline{\text{OE}}$ LOW)^[18]

Truth Table

$\overline{\text{CE}}$	$\overline{\text{WE}}$	$\overline{\text{OE}}$	Inputs/Outputs	Mode	Power
H	X	X	High Z	Deselect/Power-down	Standby (I_{SB})
L	H	L	Data Out ($\text{IO}_0\text{-IO}_7$)	Read	Active (I_{CC})
L	H	H	High Z	Output Disabled	Active (I_{CC})
L	L	X	Data in ($\text{IO}_0\text{-IO}_7$)	Write	Active (I_{CC})

Ordering Information

Speed (ns)	Ordering Code	Package Diagram	Package Type	Operating Range
55	CY62148DV30LL-55BVI	51-85149	36-ball VFBGA (6 × 8 × 1 mm)	Industrial
	CY62148DV30LL-55BVXI		36-ball VFBGA (6 × 8 × 1 mm) (Pb-free)	
	CY62148DV30L-55ZSXI	51-85095	32-pin TSOP II (Pb-free)	
	CY62148DV30LL-55ZSXI			
	CY62148DV30LL-55SXI	51-85081	32-pin SOIC (Pb-free)	
70	CY62148DV30LL-70ZSXI	51-85095	32-pin TSOP II (Pb-free)	Industrial
	CY62148DV30LL-70ZSXA	51-85095	32-pin TSOP II (Pb-free)	Automotive-A

Contact your local Cypress sales representative for availability of these parts

Package Diagrams

Figure 1. 36-ball VFBGA (6 x 8 x 1 mm), 51-85149

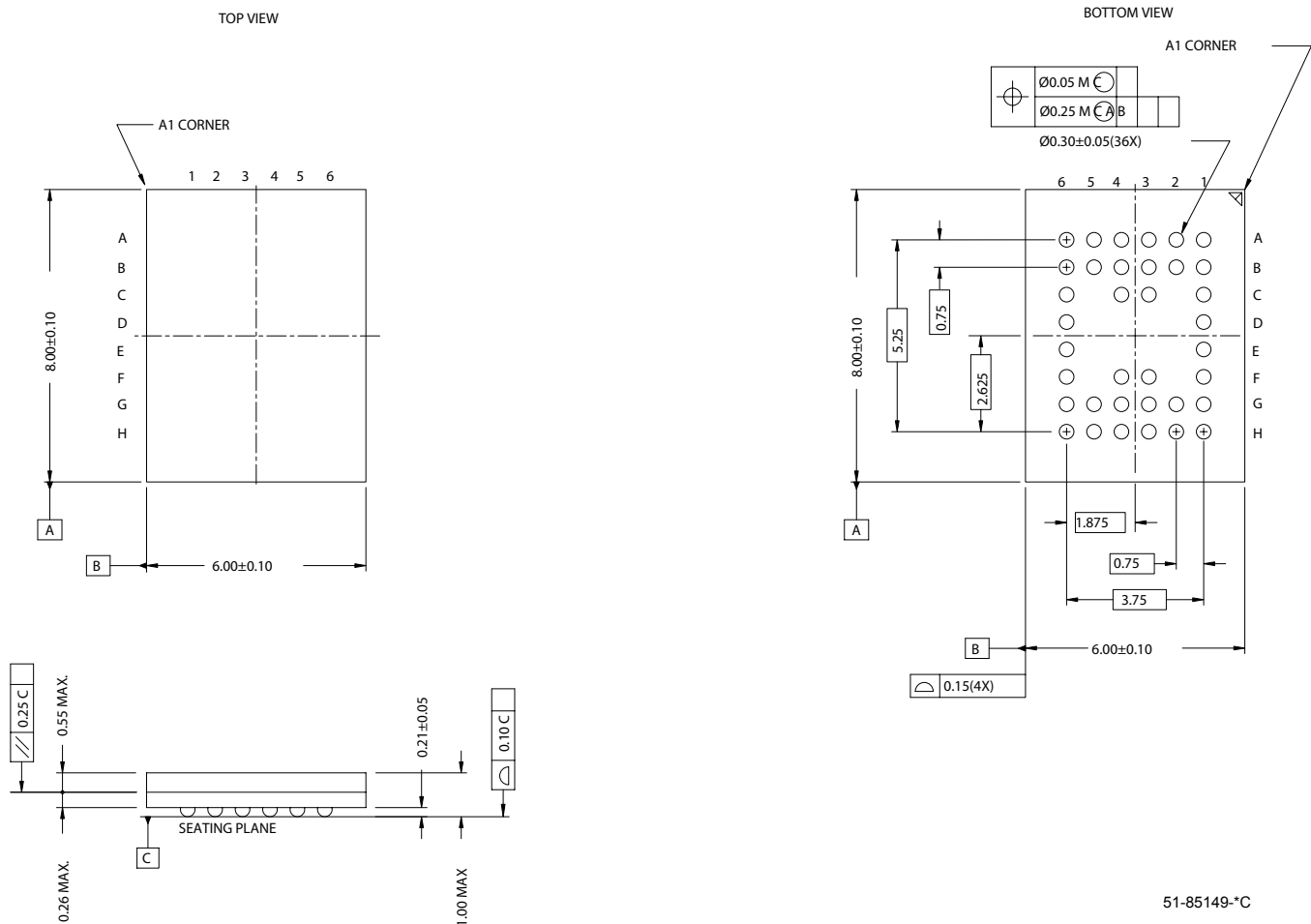

Package Diagrams (continued)

Figure 2. 32-pin TSOP II, 51-85095

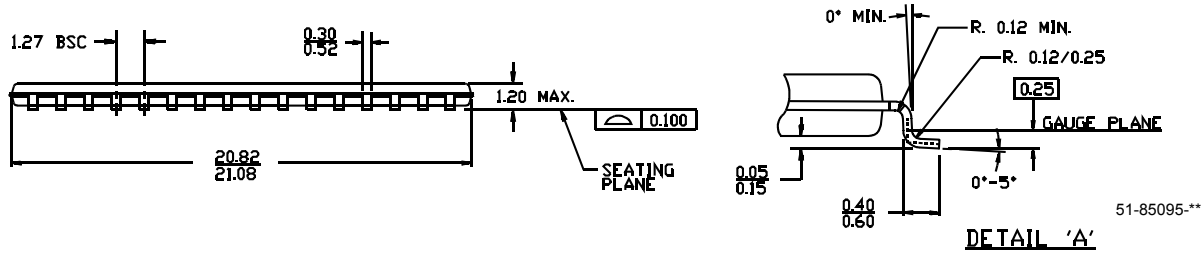
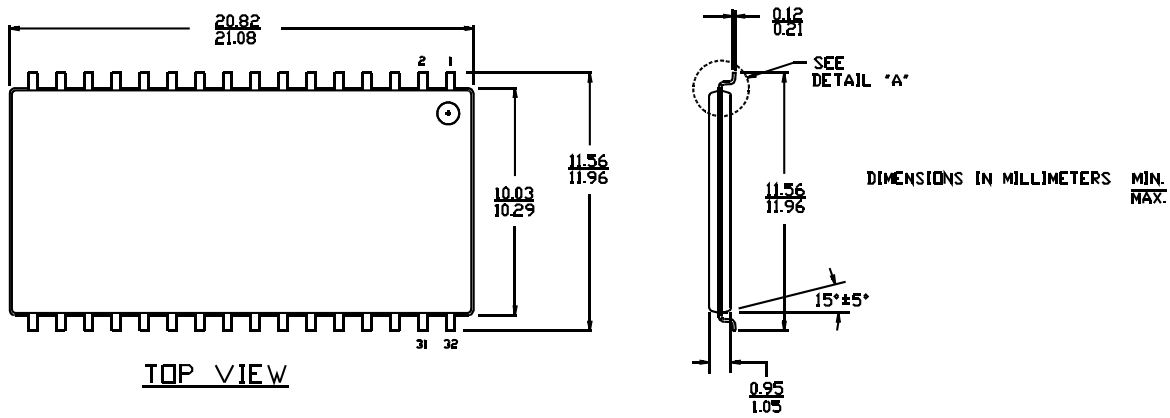
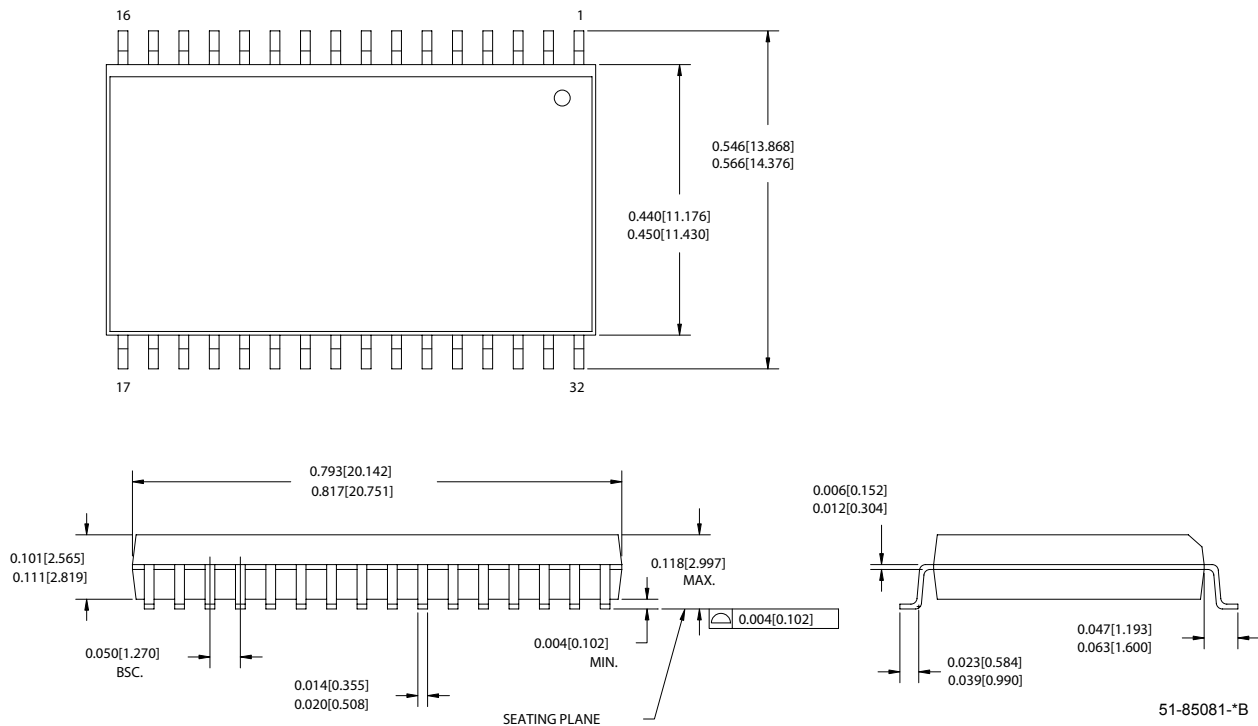

Figure 3. 32-pin (450 MIL) Molded SOIC, 51-85081



MoBL is a registered trademark, and More Battery Life is a trademark, of Cypress Semiconductor. All product and company names mentioned in this document may be the trademarks of their respective holders.

Document History Page

Document Title: CY62148DV30, 4-Mbit (512K x 8) MoBL [®] Static RAM				
Document Number: 38-05341				
REV.	ECN NO.	Issue Date	Orig. of Change	Description of Change
**	127480	06/17/03	HRT	Created new data sheet
*A	131041	01/23/04	CBD	Changed from Advance to Preliminary
*B	222180	See ECN	AJU	Changed from Preliminary to Final Added 70 ns speed bin Modified footnote #6 and #12 Removed MAX value for V _{DR} on "Data Retention Characteristics" table Modified input and output capacitance values Added Pb-free ordering information Removed 32-pin STSOP package
*C	498575	See ECN	NXR	Added Automotive-A Operating Range Removed SOIC package from Product Offering Updated Ordering Information Table
*D	729917	See ECN	VKN	Added SOIC package and its related information Updated Ordering Information Table