

Features

- Packaged NAND flash memory with MultiMediaCard interface
- Up to 2 Gbytes of formatted data storage
- eMMC/MultiMediaCard system specification, compliant with V4.3
- Full backward compatibility with previous MultiMediaCard system specification
- Bus mode
 - High-speed MultiMediaCard protocol
 - Three different data bus widths: 1 bit, 4 bits, 8 bits
 - Data transfer rate: up to 52 Mbyte/s
- Operating voltage range:
 - $V_{CCQ} = 1.8\text{ V}/3.3\text{ V}$
 - $V_{CC} = 3.3\text{ V}$
- Multiple block read (x8 at 52 MHz): up to 15 Mbyte/s
- Multiple block write (x8 at 52 MHz): up to 6 Mbyte/s
- Power dissipation
 - Standby current: down to 200 μA (typ)
 - Read current: down to 40 mA (typ)
 - Write current: down to 100 mA (typ)

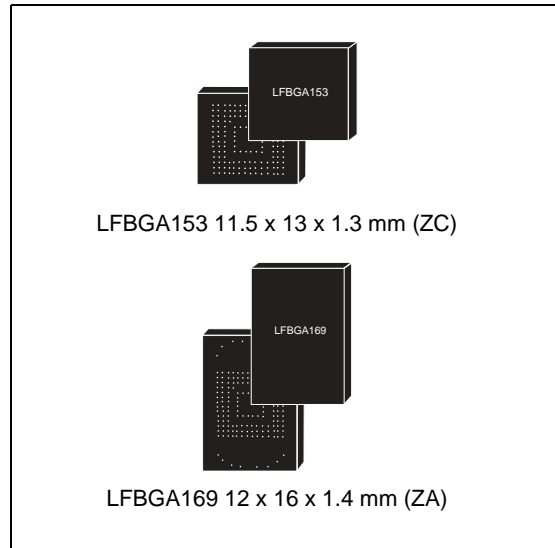

- Error free memory access
 - Internal error correction code
 - Internal enhanced data management algorithm (wear levelling, bad block management, garbage collection)
 - Possibility for the host to make sudden power failure safe-update operations for data content
- Security
 - Password protection of data
 - Built-in write protection
- Boot
 - Simple boot sequence method
- Power save
 - Enhanced power saving method by introducing sleep functionality

Table 1. Device summary

Root part number	Package	Operating voltage
NAND08GAH0J	LFBGA153	$V_{CC} = 3.3\text{ V}, V_{CCQ} = 1.8\text{ V}/3.3\text{ V}$
NAND16GAH0H	LFBGA169	

Contents

1	Description	6
1.1	eMMC Standard Specification	6
2	Product specification	7
2.1	System performance	7
3	Device physical description	8
3.1	Package connections	9
3.2	Form factor	10
4	Memory array partitioning	11
5	MultiMediaCard interface	12
5.1	Signals description	12
5.1.1	Clock (CLK)	12
5.1.2	Command (CMD)	12
5.1.3	Input/outputs (DAT0-DAT7)	12
5.1.4	V _{CC} core supply voltage	12
5.1.5	V _{SS} ground	12
5.1.6	V _{CCQ} input/output supply voltage	13
5.1.7	V _{SSQ} supply voltage	13
5.2	Bus topology	14
5.3	Power-up	14
5.4	Power cycling	14
5.5	Bus operating conditions	16
5.6	Bus signal levels	16
5.7	Bus timing	16
6	High speed MultiMediaCard operation	17
6.1	Boot mode	17
6.2	Identification mode	17
6.3	Data transfer mode	17
6.4	Clock control	17

6.5	Error conditions	17
6.6	Commands	18
6.7	State transition	18
6.8	Response	18
6.9	Timing diagrams and values	18
6.10	Minimum performance	18
7	Device registers	19
7.1	Operation conditions register (OCR)	19
7.2	Card identification (CID) register	20
7.3	Card specific data register (CSD)	20
7.4	Extended CSD register	22
7.5	RCA (relative card address) register	25
7.6	DSR (driver stage register) register	25
7.7	Status register	25
8	Package mechanical	26
9	Ordering information	30
10	Revision history	31

List of tables

Table 1.	Device summary	1
Table 2.	System performance	7
Table 3.	Current consumption	7
Table 4.	Communication channel performance	7
Table 5.	Signal names	13
Table 6.	OCR register definition	19
Table 7.	Card identification (CID) register	20
Table 8.	Card specific data register	21
Table 9.	Extended CSD	22
Table 10.	LFPGA153 11.5 x 13 x 1.3 mm 132+21 3R14 - 0.50 mm, mechanical data	27
Table 11.	LFPGA169 12 x 16 x 1.4 mm 132+21+16 3R14 0.50 mm, mechanical data	29
Table 12.	Ordering information scheme	30
Table 13.	Document revision history	31

List of figures

Figure 1.	Device block diagram	8
Figure 2.	LFPGA153 package connections (top view through package).	9
Figure 3.	LFPGA169 package connections (top view through package).	10
Figure 4.	Form factor	10
Figure 5.	Memory array structure.	11
Figure 6.	Power-up	15
Figure 7.	Power cycling	15
Figure 8.	LFPGA153 11.5 x 13 x 1.3 mm 132+21 3R14 - 0.50 mm, package outline	26
Figure 9.	LFPGA169 12 x 16 x 1.4 mm 132+21+16 3R14 0.50 mm, package outline	28

1 Description

The NANDxxxAH0H/J is an embedded flash memory storage solution with MultiMediaCard™ interface (eMMC™). The eMMC™ was developed for universal low-cost data storage and communication media. The NANDxxxAH0H/J is fully compatible with MMC bus and hosts.

The NANDxxxAH0H/J communications are made through an advanced 13-pin bus. The bus can be either 1-bit, 4-bit, or 8-bit in width. The device operates in high-speed mode at clock frequencies equal to or higher than 20 MHz, which is the MMC standard. The communication protocol is defined as a part of this MMC standard and referred to as MultiMediaCard mode.

The device is designed to cover a wide area of applications such as smart phones, cameras, organizers, PDA, digital recorders, MP3 players, pagers, electronic toys, etc. They feature high performance, low power consumption, low cost and high density.

To meet the requirements of embedded high density storage media and mobile applications, the NANDxxxAH0H/J supports both 3.3 V supply voltage (V_{CC}), and 1.8 V/3.3 V input/output voltage (V_{CCQ}).

The address argument for the NANDxxxAH0H/J is the byte address.

The device has a built-in intelligent controller which manages interface protocols, data storage and retrieval, wear leveling, bad block management, garbage collection, and internal ECC.

The NANDxxxAH0H/J makes available to the host sudden power failure safe-update operations for the data content, by supporting reliable write features.

The device supports boot operation and sleep/awake commands. In particular, during the sleep state the host power regulator for V_{CC} can be switched off, thus minimizing the power consumption of the NANDxxxAH0H/J.

The system performance and characteristics are given in [Table 2](#), [Table 3](#), and [Table 4](#).

1.1 eMMC Standard Specification

The NANDxxxAH0H/J device is fully compatible with the JEDEC Standard Specification No. JESD84-A43.

This datasheet describes the key and specific features of the NANDxxxAH0H/J device. Any additional information required to interface the device to a host system and all the practical methods for card detection and access can be found in the proper sections of the JEDEC Standard Specification.

2 Product specification

2.1 System performance

Table 2. System performance

System performance	Typical value ⁽¹⁾		Unit
	NAND08GAH0J, NAND16GAH0H		
Multiple block read sequential ⁽²⁾	15		Mbyte/s
Multiple block read 64-Kbyte chunk ⁽³⁾	10.5		Mbyte/s
Multiple block write sequential ⁽²⁾	6		Mbyte/s
Multiple block write 64-Kbyte chunk ⁽³⁾	2.8		Mbyte/s

1. Values given for an 8-bit bus width, a clock frequency of 52 MHz, $V_{CC} = 3.3\text{ V}$ and $V_{CCQ} = 1.8\text{ V}$.

2. Based on a 4-Mbyte file transfer.

3. Test performed by writing/reading a 64-Kbyte chunk of data to/from random logical addresses (aligned to physical block boundaries) of the card. The performance is calculated as an average out of several 64-Kbyte accesses.

Table 3. Current consumption

Operation	Test conditions	Current consumption ⁽¹⁾				Unit
		NAND08GAH0J		NAND16GAH0H		
		Typ	Max	Typ	Max	
Read	$V_{CC} = 3.3\text{ V} \pm 5\%$ $V_{CCQ} = 1.8\text{ V} \pm 5\%$	40	80	40	80	mA
Write		100	150	100	150	
Standby	$V_{CC} = 3.3\text{ V} \pm 5\%$	10		10		μA
	$V_{CCQ} = 1.8\text{ V} \pm 5\%$	80		80		

1. Values given for an 8-bit bus width and a clock frequency of 26 MHz.

Table 4. Communication channel performance

MultiMediaCard communication channel performance
Three-wire serial data bus (clock, command, data)
Variable clock rate 0, 26, 52 MHz
Easy card identification
Error protected data transfer
Sequential and single/multiple block oriented data transfer

3 Device physical description

The NANDxxxAH0H/J contains a single chip controller and flash memory module, see [Figure 1: Device block diagram](#). The microcontroller interfaces with a host system allowing data to be written to and read from the flash memory module. The controller allows the host to be independent from details of erasing and programming the flash memory.

[Figure 3](#) shows the package connections. See [Table 5: Signal names](#) for the description of the signals corresponding to the balls.

Figure 1. Device block diagram

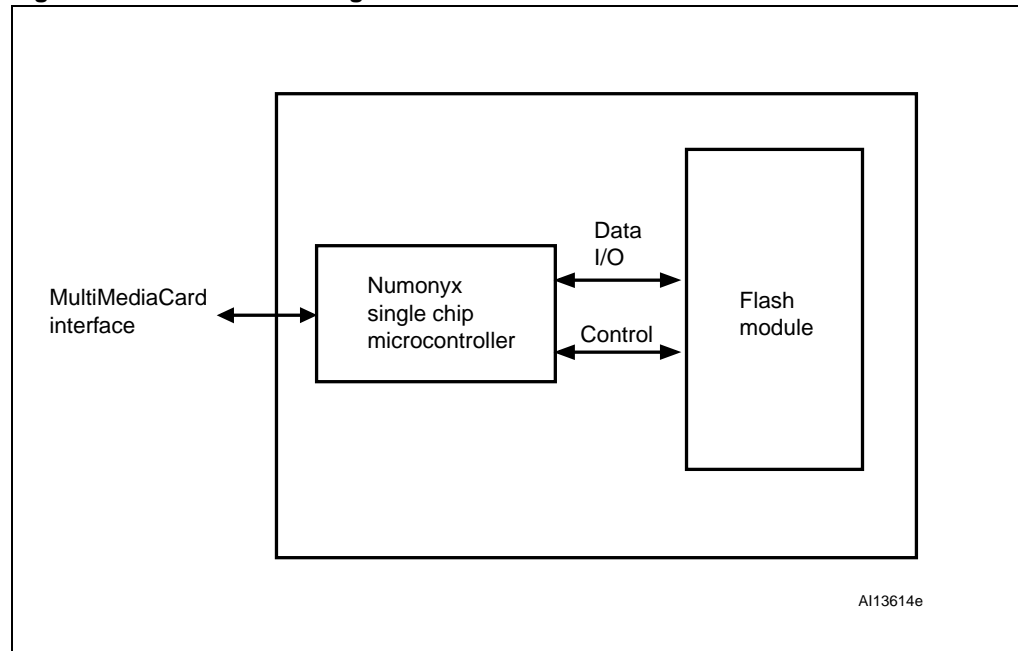

3.1 Package connections

Figure 2. LFBGA153 package connections (top view through package)

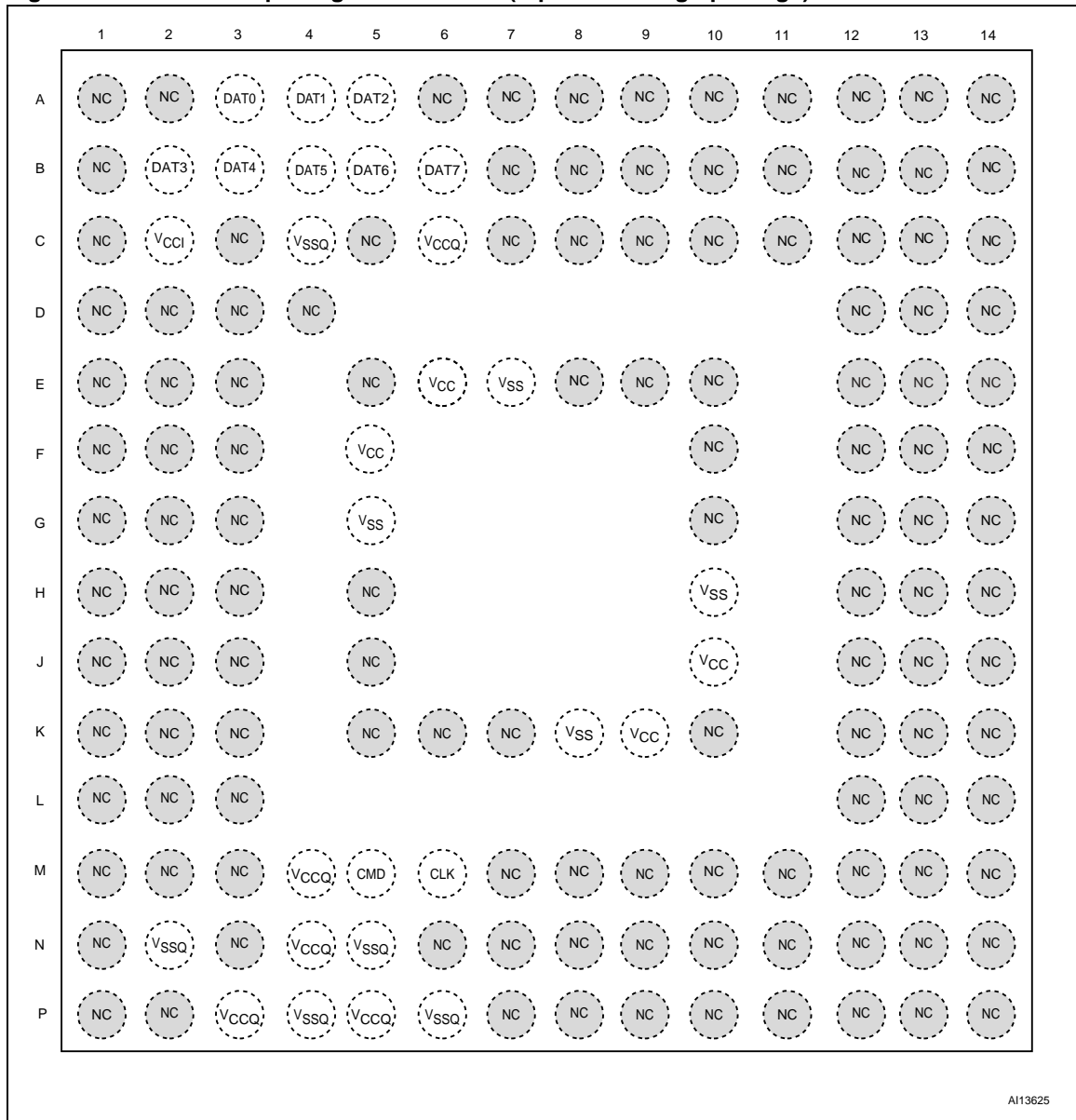

AI13625

1. The ball corresponding to VCCI must be decoupled with an external capacitance.

Figure 3. LFBGA169 package connections (top view through package)

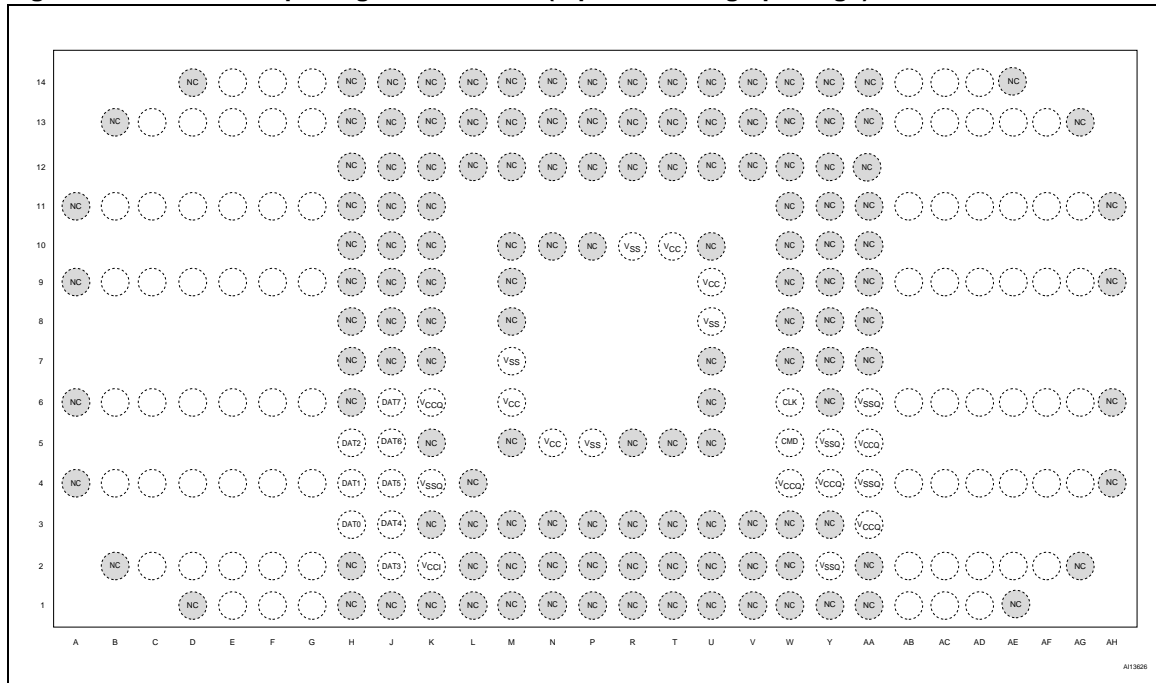

1. The ball corresponding to V_{CC1} must be decoupled with an external capacitance.

3.2 Form factor

The ball diameter, d , and the ball pitch, p , for LFBGA153 and LFBGA169 packages are:

- $d = 0.30 \text{ mm}$ (solder ball diameter)
- $p = 0.5 \text{ mm}$ (ball pitch)

Figure 4. Form factor

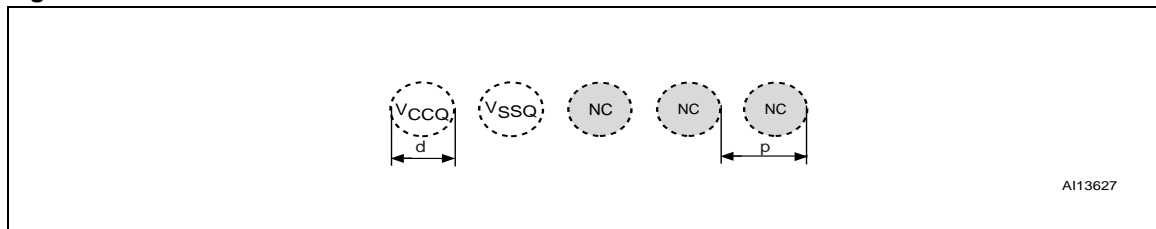

4 Memory array partitioning

The basic unit of data transfer to/from the device is one byte. All data transfer operations which require a block size always define block lengths as integer multiples of bytes. Some special functions need other partition granularity.

For block oriented commands, the following definitions are used:

- **Block:** the unit which is related to the block oriented read and write commands. Its size is the number of bytes which are transferred when one block command is issued by the host. The size of a block is either programmable or fixed. The information about allowed block sizes and the programmability is stored in the CSD register.
- **Erase group:** the unit which is related to special erase and write commands defined for R/W cards. Its size is the smallest number of consecutive write blocks which can be addressed for erase. The size of the erase group depends on each device and is stored in the CSD.
- **Write protect group:** the smallest unit that may be individually write protected. Its size is defined in units of erase groups. The size of a WP-group depends on each device and is stored in the CSD.

Figure 5 shows the NANDxxxAH0H/J memory array organization.

Figure 5. Memory array structure

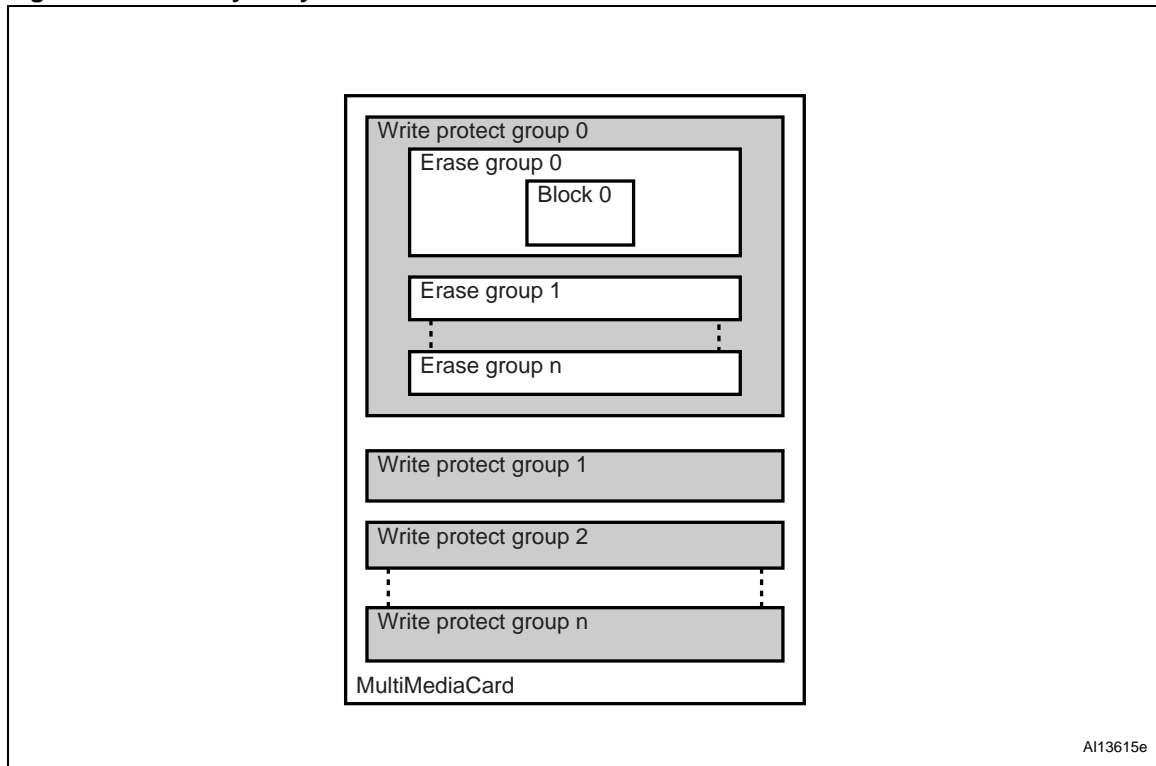

1. n = number of last erase group or last write protect group.

5 MultiMediaCard interface

The signal/pin assignments are listed in [Table 5](#). Refer to this table in conjunction with [Figure 3](#) and [Figure 4: Form factor](#).

5.1 Signals description

5.1.1 Clock (CLK)

The Clock input, CLK, is used to synchronize the memory to the host during command and data transfers. Each clock cycle gates one bit on the command and on all the data lines. The Clock frequency, f_{PP} , may vary between zero and the maximum clock frequency.

5.1.2 Command (CMD)

The CMD signal is a bidirectional command channel used for device initialization and command transfer. The CMD signal has two operating modes: open-drain and push-pull. The open-drain mode is used for initialization, while the push-pull mode is used for fast command transfer. Commands are sent by the MultiMediaCard bus master (or host) to the device who responds by sending back responses.

5.1.3 Input/outputs (DAT0-DAT7)

DAT0 to DAT7 are bidirectional data channels. The signals operate in push-pull mode. The NANDxxxAH0H/J includes internal pull ups for all data lines. These signals cannot be driven simultaneously by the host and the NANDxxxAH0H/J device. Right after entering the 4-bit mode, the card disconnects the internal pull ups of lines DAT1 and DAT2 (DAT3 internal pull up is left connected due to the SPI mode CS backward compatible usage). Correspondingly right after entering the 8-bit mode, the card disconnects the internal pull ups of lines DAT1, DAT2 and DAT4-DAT7.

By default, after power-up or hardware reset, only DAT0 is used for data transfers. The host can configure the device to use a wider data bus, DAT0, DAT0-DAT3 or DAT0-DAT7, for data transfer.

5.1.4 V_{CC} core supply voltage

V_{CC} provides the power supply to the internal core of the memory device. It is the main power supply for all operations (read, program and erase). The core voltage (V_{CC}) can be within 2.7 V and 3.6 V.

5.1.5 V_{SS} ground

Ground, V_{SS} , is the reference for the power supply. It must be connected to the system ground.

5.1.6 V_{CCQ} input/output supply voltage

V_{CCQ} provides the power supply to the I/O pins and enables all outputs to be powered independently from V_{CC} .

The input/output voltage (V_{CCQ}) can be either within 1.65/1.7 V and 1.95 V (low voltage range) or 2.7 V and 3.6 V (high voltage range).

5.1.7 V_{SSQ} supply voltage

V_{SSQ} ground is the reference for the input/output circuitry driven by V_{CCQ} .

Table 5. Signal names

Name	Type ⁽¹⁾	Description
DAT0	I/O (PP)	Data
DAT1	I/O (PP)	Data
DAT2	I/O (PP)	Data
DAT3	I/O (PP)	Data
DAT4	I/O (PP)	Data
DAT5	I/O (PP)	Data
DAT6	I/O (PP)	Data
DAT7	I/O (PP)	Data
CMD	I/O (OD or PP)	Command
CLK	I (PP)	Clock
V_{CCQ}		Input/output power supply
V_{CC}		Core power supply
V_{SSQ}		Input/output ground
V_{CCI}	I	Must be decoupled with an external capacitance
V_{SS}		Ground
NC	NC	Not connected ⁽²⁾

1. I: input; O: output, OD: open drain, PP: push-pull.

2. NC pins can be connected to ground or left floating.

5.2 Bus topology

The NANDxxxAH0H/J device supports the MMC protocol. For more details, refer to section 6.4 of the JEDEC Standard Specification No. JESD84-A43. The section 12 of the JEDEC Standard Specification contains a bus circuitry diagram for reference.

5.3 Power-up

The power-up is handled locally in each device and in the bus master. [Figure 6: Power-up](#) shows the power-up sequence. Refer to section 12.3 of the JEDEC Standard Specification No. JESD84-A43 for specific instructions regarding the power-up sequence.

After power-up, the maximum initial load the NANDxxxAH0H/J can present on the V_{CC} line is C_4 , in parallel with a minimum of R_4 . During operation, device capacitance on the V_{CC} line must not exceed 10 μF .

5.4 Power cycling

The bus master can execute any sequences of V_{CC} and V_{CCQ} power-up/power down. However, the master must not issue any commands until V_{CC} and V_{CCQ} are stable within each operating voltage range. For more information about power cycling see Section 12.3.3 of the JEDEC Standard Specification No. JESD84-A43 and [Figure 7: Power cycling](#).

Figure 6. Power-up

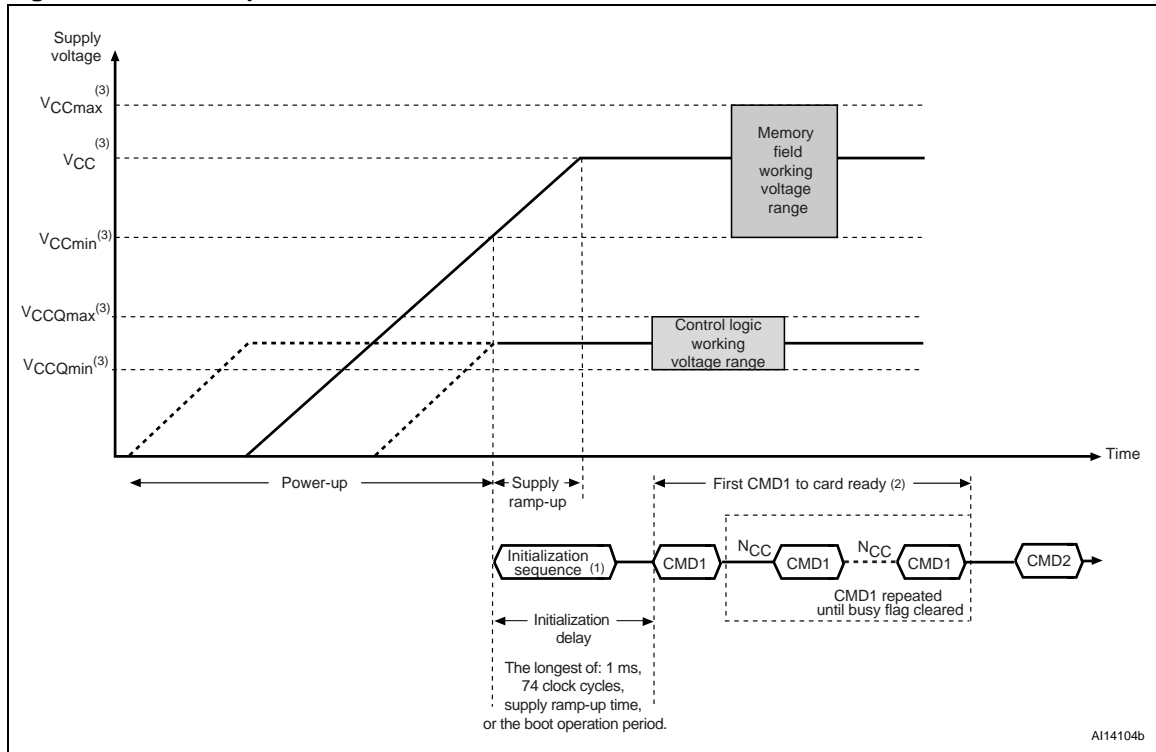

1. The initialization sequence is a contiguous stream of logic 1's. Its length is either 1 ms, 74 clocks or the supply ramp up time, whichever is the longest. The device shall complete its initialization within 1 second from the first CMD1 with a valid V range.
2. N_{CC} is the number of clock cycles.
3. Refer to [Section 7.1: Operation conditions register \(OCR\)](#) for details on voltage ranges.

Figure 7. Power cycling

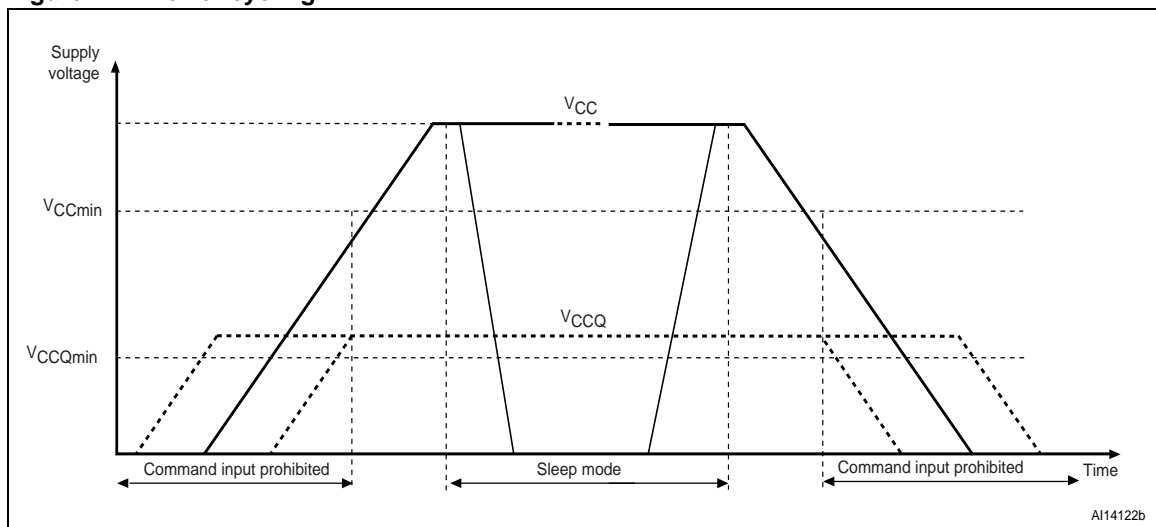

5.5 Bus operating conditions

Refer to section 12.6 of the JEDEC Standard Specification No. JESD84-A43.

5.6 Bus signal levels

Refer to section 12.6 of the JEDEC Standard Specification No. JESD84-A43.

5.7 Bus timing

Refer to section 12.7 of the JEDEC Standard Specification No. JESD84-A43.

6 High speed MultiMediaCard operation

All communication between the host and the device is controlled by the host (master).

The following section provides an overview of the identification and data transfer modes, commands, dependencies, various operation modes and restrictions for controlling the clock signal. For detailed information, refer to section 7 of the JEDEC Standard Specification No. JESD84-A43.

6.1 Boot mode

The host can read boot data from NANDxxxAH0H/J by keeping CMD line Low after power-on or sending CMD0 with argument + 0xFFFFFFFF (optional for slave), before issuing CMD1. The data can be read from either boot area or user area depending on the register setting. Refer to section 7.2 of the JEDEC Standard Specification No. JESD84-A43.

6.2 Identification mode

When in card identification mode, the host resets the NANDxxxAH0H/J, validates the operating voltage range and the access mode, identifies the device and assigns a relative address (RCA) to it. For more information see section 7.3 of the JEDEC Standard Specification No. JESD84-A43.

6.3 Data transfer mode

The device enters data transfer mode once an RCA is assigned to it. When the device is in standby mode, issuing the CMD7 command along with the RCA, selects the device and puts it into the transfer state. The host enters data transfer mode after identifying the NANDxxxAH0H/J on the bus. When the device is in standby state, communication over the CMD and DAT lines is in push-pull mode.

The section 7.5 of the JEDEC Standard Specification No. JESD84-A43 contains more detailed information about data read and write, erase, write protect management, lock/unlock operations, the switch function command, high speed mode selection, and bus testing procedure. Moreover section 7.5.7 contains a detailed description of the reliable write features supported by the NANDxxxAH0H/J.

6.4 Clock control

Refer to section 7.6 of the JEDEC Standard Specification No. JESD84-A43.

6.5 Error conditions

Refer to section 7.7 of the JEDEC Standard Specification No. JESD84-A43.

6.6 Commands

Refer to section 7.9 of the JEDEC Standard Specification No. JESD84-A43.

6.7 State transition

Refer to section 7.10 and 7.12 of the JEDEC Standard Specification No. JESD84-A43.

6.8 Response

Refer to section 7.11 of the JEDEC Standard Specification No. JESD84-A43.

6.9 Timing diagrams and values

Refer to section 7.14 of the JEDEC Standard Specification No. JESD84-A43.

6.10 Minimum performance

Refer to section 7.8 of the JEDEC Standard Specification No. JESD84-A43.

7 Device registers

There are five different registers within the device interface:

- Operation conditions register (OCR)
- Card identification register (CID)
- Card specific data register (CSD)
- Relative card address register (RCA)
- DSR (driver stage register)
- Extended card specific data register (EXT_CSD).

These registers are used for the serial data communication and can be accessed only using the corresponding commands (refer to section 7.9 of the JEDEC Standard Specification No. JESD84-A43. The device does not implement the DSR register.

The MultiMediaCard has a status register to provide information about the device current state and completion codes for the last host command.

7.1 Operation conditions register (OCR)

The 32-bit operation conditions register stores the V_{CCQ} , the input/output voltage of the flash memory component. The device is capable of communicating (identification procedure and data transfer) with any MultiMediaCard host using any operating voltage within 1.7 V and 1.95 V (low-voltage range) or 2.7 V and 3.6 V (high-voltage range) depending on the voltage range supported by the host. For further details, refer to section 8.1 of the JEDEC Standard Specification No. JESD84-A43.

If the host tries to change the OCR values during an initialization procedure the changes in the OCR content will be ignored.

The level coding of the OCR register is as follows:

- Restricted voltage windows = Low
- Device busy = Low

Table 6. OCR register definition

OCR bit	Description	MultiMediaCard
6 to 0	Reserved	000 0000b
7	Low V_{CCQ}	1b
14 to 8	2.0 - 2.6	000 0000b
23 to 15	2.7 - 3.6 (High V_{CCQ} range)	1 1111 1111b
28 to 24	Reserved	000 0000b
30 to 29	Access mode	00b (byte mode)
31	Power-up status bit (busy) ⁽¹⁾	

1. This bit is set to Low if the device has not finished the power-up routine.

7.2 Card identification (CID) register

The CID register is 16-byte long and contains a unique card identification number used during the card identification procedure. It is a 128-bit wide register with the content as defined in [Table 7](#). It is programmed during device manufacturing and can not be changed by MultiMediaCard hosts. For details, refer to section 8.2 of the JEDEC Standard Specification No. JESD84-A43.

Table 7. Card identification (CID) register

Name	Field	Width	CID - slice	CID - value	Note
Manufacturer ID	MID	8	[127:120]	0xFE	
Reserved		6	[119:114]		
Card/BGA	CBX	2	[113:112]	0x01	BGA
OEM/application ID	OID	8	[111:104]	TBD	
Product name	PNM	48	[103:56]	MMC01G, MMC02G	
Product revision	PRV	8	[55:48]		
Product serial number	PSN	32	[47:16]	TBD	
Manufacturing date	MDT	8	[15:8]	TBD	
CRC7 checksum	CRC	7	[7:1]	TBD	
Not used, always '1'	–	1	[0:0]	1	

7.3 Card specific data register (CSD)

All the configuration information required to access the device data is stored in the CSD register. The MSB bytes of the register contain the manufacturer data and the two least significant bytes contains the host controlled data (the device copy, write protection and the user ECC register).

The host can read the CSD register and alter the host controlled data bytes using the SEND_CSD and PROGRAM_CSD commands.

In [Table 8](#), the cell type column defines the CSD field as read only (R), one time programmable (R/W) or erasable (R/W/E). The programmable part of the register (entries marked by W or E) can be changed by command CMD27.

The copy bit in the CSD can be used to mark the device as an original or a copy. Once set it cannot be cleared. The device can be purchased with the copy bit set (copy) or cleared, indicating the device is a master.

The one time programmable (OTP) characteristic of the copy bit is implemented in the MultiMediaCard controller firmware and not with a physical OTP cell.

For details, refer to section 8.3 of the JEDEC Standard Specification No. JESD84-A43.

Table 8. Card specific data register

Name	Field	Width [bits]	Cell type	CSD-slice	CSD-value
CSD structure	CSD_STRUCTURE	2	R	[127:126]	2
MultiMediaCard protocol version	SPEC_VERS	4	R	[125:122]	4
Reserved		2	R	[121:120]	TBD
Data read access-time-1	TAAC	8	R	[119:112]	79
Data read access-time-2 in CLK cycles (NSAC*100)	NSAC	8	R	[111:104]	
Max. data transfer rate	TRAN_SPEED	8	R	[103:96]	50
Command classes	CCC	12	R	[95:84]	245
Max. read data block length	READ_BL_LEN	4	R	[83:80]	512 for NAND08GAH0J
					1024 for NAND16GAH0H
Partial blocks for read allowed	READ_BL_PARTIAL	1	R	[79:79]	1
Write block misalignment	WRITE_BLK_MISALIGN	1	R	[78:78]	0x00
Read block misalignment	READ_BLK_MISALIGN	1	R	[77:77]	0
DSR implemented	DSR_IMP	1	R	[76:76]	0x00
Reserved		2	R	[75:74]	TBD
Device size	C_SIZE	12	R	[73:62]	According to device density
Max. read current at $V_{CC}(\min)$	VDD_R_CURR_MIN	3	R	[61:59]	100 mA
Max. read current at $V_{CC}(\max)$	VDD_R_CURR_MAX	3	R	[58:56]	200 mA
Max. write current at $V_{CC}(\min)$	VDD_W_CURR_MIN	3	R	[55:53]	100 mA
Max. write current at $V_{CC}(\max)$	VDD_W_CURR_MAX	3	R	[52:50]	200 mA
Device size multiplier	C_SIZE_MULT	3	R	[49:47]	According to device density
Erase group size	ERASE_GRP_SIZE	5	R	[46:42]	32
Erase group size multiplier	ERASE_GRP_MULT	5	R	[41:37]	32
Write protect group size	WP_GRP_SIZE	5	R	[36:32]	According to device density
Write protect group enable	WP_GRP_ENABLE	1	R	[31:31]	1
Manufacturer default ECC	DEFAULT_ECC	2	R	[30:29]	TBD
Write speed factor	R2W_FACTOR	3	R	[28:26]	4
Max. write data block length	WRITE_BL_LEN	4	R	[25:22]	512 for NAND08GAH0J
					1024 for NAND16GAH0H

Table 8. Card specific data register (continued)

Name	Field	Width [bits]	Cell type	CSD-slice	CSD-value
Partial blocks for write allowed	WRITE_BL_PARTIAL	1	R	[21:21]	0
Reserved				[20:20]	TBD
Content protection application	CONTENT_PROT_APP	1	R	[16:16]	0
File format group	FILE_FORMAT_GROUP	1	R/W	[15:15]	0
Copy flag (OTP)	COPY	1	R/W	[14:14]	0
Permanent write protection	PERM_WRITE_PROTECT	1	R/W	[13:13]	0
Temporary write protection	TMP_WRITE_PROTECT	1	R/W/E	[12:12]	0
File format	FILE_FORMAT	2	R/W	[11:10]	Hard disk like file system with partition table
ECC code 2 R/W/E none 0	ECC	2	R/W/E	[9:8]	0
CRC	CRC	7	R/W/E	[7:1]	TBD
Not used, always '1'		1	–	[0:0]	TBD

7.4 Extended CSD register

The extended CSD register defines the device properties and selected modes. It is 512-byte long. The 320 most significant bytes are the properties segment that defines the device capabilities and cannot be modified by the host. The 192 lower bytes are the modes segment that defines the configuration the device is working in. For details, refer to section 8.4 of the JEDEC Standard Specification No. JESD84-A43.

These modes can be changed by the host by means of the Switch command.

Table 9. Extended CSD⁽¹⁾

Name	Field	Size (bytes)	Cell type	CSD-slice	CSD-slice value
Properties segment					
Reserved ⁽²⁾		7		[511:505]	TBD
Supported command sets	S_CMD_SET	1	R	[504]	0
Reserved ⁽²⁾		275	TBD	[503:229]	TBD
Boot information	BOOT_INFO	1	R	[228]	1
Reserved ⁽²⁾		1	TBD	[227]	TBD
Boot partition size	BOOT_SIZE_MULT	1	R	[226]	256 Kbytes
Access size	ACC_SIZE	1	R	[225]	0
High-capacity erase unit size	HC_ERASE_GRP_SIZE	1	R	[224]	0
High-capacity erase timeout	ERASE_TIMEOUT_MULT	1	R	[223]	0
Reliable write sector count	REL_WR_SEC_C	1	R	[222]	1 sector

Table 9. Extended CSD⁽¹⁾ (continued)

Name	Field	Size (bytes)	Cell type	CSD-slice	CSD-slice value
High-capacity write protect group size	HC_WP_GRP_SIZE	1	R	[221]	0
Sleep current (V_{CC})	S_C_VCC	1	R	[220]	TBD
Sleep current (V_{CCQ})	S_C_VCCQ	1	R	[219]	TBD
Reserved ⁽²⁾		1	TBD	[218]	TBD
Sleep/awake timeout	S_A_TIMEOUT	1	R	[217]	TBD
Reserved ⁽²⁾		1	TBD	[216]	TBD
Sector count	SEC_COUNT	4	R	[215:212]	0
Reserved ⁽²⁾		1		[211]	TBD
Minimum write performance for 8 bit at 52 MHz	MIN_PERF_W_8_52	1	R	[210]	8
Minimum read performance for 8 bit at 52 MHz	MIN_PERF_R_8_52	1	R	[209]	8
Minimum write performance for 8 bit at 26 MHz, for 4 bit at 52 MHz	MIN_PERF_W_8_26_4_52	1	R	[208]	8
Minimum read performance for 8 bit at 26 MHz, for 4 bit at 52 MHz	MIN_PERF_R_8_26_4_52	1	R	[207]	8
Minimum write performance for 4 bit at 26 MHz	MIN_PERF_W_4_26	1	R	[206]	8
Minimum read performance for 4 bit at 26 MHz	MIN_PERF_R_4_26	1	R	[205]	8
Reserved ⁽²⁾		1		[204]	TBD
Power class for 26 MHz at 3.6 V	PWR_CL_26_360	1	R	[203]	0
Power class for 52 MHz at 3.6 V	PWR_CL_52_360	1	R	[202]	0
Power class for 26 MHz at 1.95 V	PWR_CL_26_195	1	R	[201]	0
Power class for 52 MHz at 1.95 V	PWR_CL_52_195	1	R	[200]	0
Reserved ⁽²⁾		3		[199:197]	TBD
Card type	CARD_TYPE	1	R	[196]	3
Reserved ⁽²⁾		1		[195]	TBD
CSD structure version	CSD_STRUCTURE	1	R	[194]	2

Table 9. Extended CSD⁽¹⁾ (continued)

Name	Field	Size (bytes)	Cell type	CSD-slice	CSD-slice value
Reserved ⁽²⁾		1		[193]	TBD
Extended CSD revision	EXT_CSD_REV	1	R	[192]	2
Modes segment					
Command set	CMD_SET	1	R/W	[191]	0
Reserved ⁽²⁾		1		[190]	TBD
Command set revision	CMD_SET_REV	1	RO	[189]	0
Reserved ⁽²⁾		1		[188]	TBD
Power class	POWER_CLASS	1	R/W	[187]	0
Reserved ⁽²⁾		1		[186]	TBD
High speed interface timing	HS_TIMING	1	R/W	[185]	0
Reserved ⁽²⁾		1		[184]	TBD
Bus width mode	BUS_WIDTH	1	WO	[183]	2
Reserved ⁽²⁾		1		[182]	TBD
Erased memory content	ERASED_MEM_CONT	1	RO	[181]	TBD
Reserved ⁽²⁾		1		[180]	TBD
Boot configuration	BOOT_CONFIG	1	R/W	[179]	0
Reserved ⁽²⁾		1		[178]	TBD
Boot bus width 1	BOOT_BUS_WIDTH	1	R/W	[177]	0
Reserved ⁽²⁾		1		[176]	TBD
High-density erase group definition	ERASE_GROUP_DEF	1	R/W	[175]	0
Reserved ⁽²⁾		175		[174:0]	TBD

1. TBD stands for 'to be defined'.

2. Reserved bits should read as '0'.

7.5 RCA (relative card address) register

The writable 16-bit relative card address (RCA) register carries the device address assigned by the host during the device identification. This address is used for the addressed host-card communication after the device identification procedure. The default value of the RCA register is '0x0001'. The value '0x0000' is reserved to set all cards into the standby state with CMD7. For details refer to section 8.5 of the JEDEC Standard Specification No. JESD84-A43.

7.6 DSR (driver stage register) register

The 16-bit driver stage register (DSR) can be optionally used to improve the bus performance for extended operating conditions (depending on parameters like bus length, transfer rate or number of devices on the bus).

The CSD register contains the information concerning the DSR register usage.

The default value of the DSR register is '0x404'. For details refer to section 8.6 of the JEDEC Standard Specification No. JESD84-A43.

7.7 Status register

The status register provides information about the device current state and completion codes for the last host command. The device status can be explicitly read (polled) with the SEND_STATUS command. The MultiMediaCard status register structure is defined in section 7.12 of the JEDEC Standard Specification No. JESD84-A43.

8 Package mechanical

To meet environmental requirements, Numonyx offers these devices in RoHS compliant packages, which have a lead-free second-level interconnect. The category of second-level interconnect is marked on the package and on the inner box label, in compliance with JEDEC Standard JESD97. The maximum ratings related to soldering conditions are also marked on the inner box label.

RoHS compliant specifications are available at www.numonyx.com.

Figure 8. LFBGA153 11.5 x 13 x 1.3 mm 132+21 3R14 - 0.50 mm, package outline

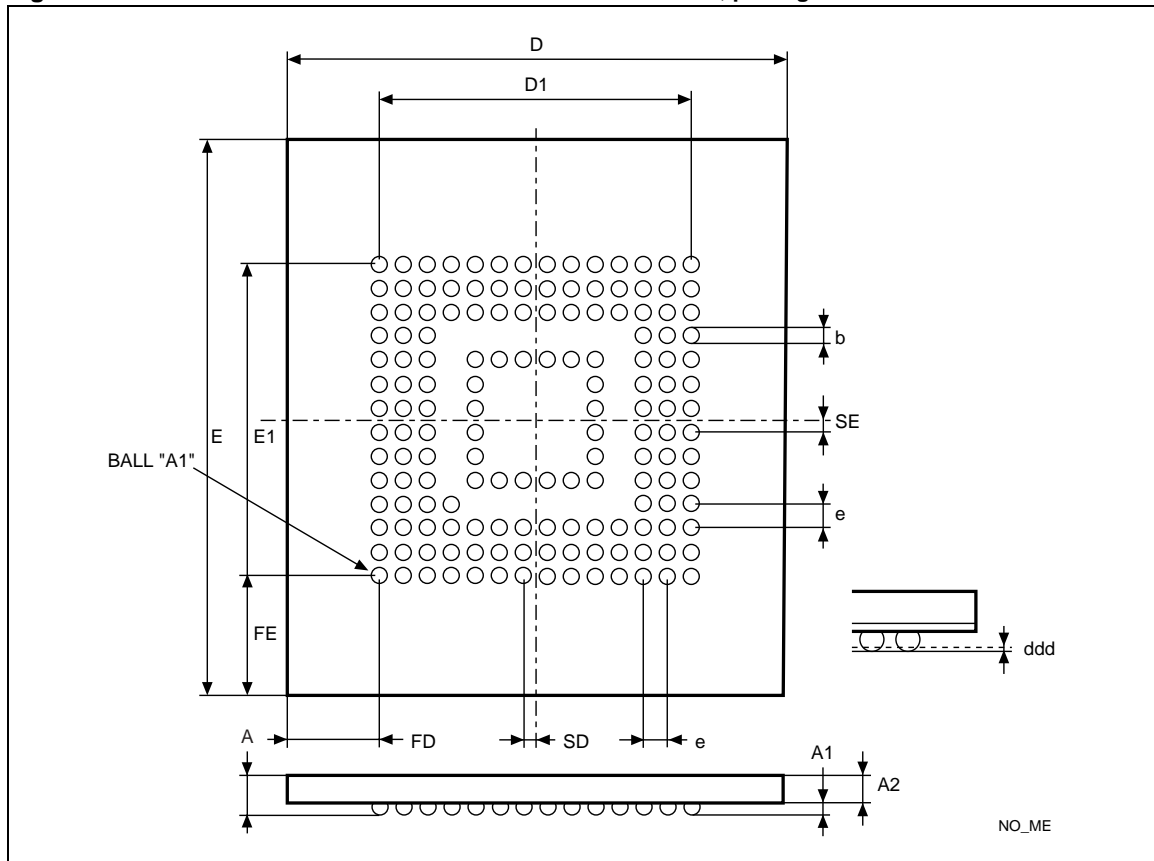

1. Drawing is not to scale.

Table 10. LFBGA153 11.5 x 13 x 1.3 mm 132+21 3R14 - 0.50 mm, mechanical data

Symbol	millimeters			inches		
	Typ	Min	Max	Typ	Min	Max
A			1.30			0.052
A1		0.15			0.006	
A2	1.00			0.039		
b	0.30	0.25	0.35	0.012	0.010	0.014
D	11.50	11.40	11.60	0.456	0.453	0.460
D1	6.50			0.256		
ddd			0.08			0.010
E	13.00	12.90	13.10	0.516	0.512	0.520
E1	6.50			0.256		
e	0.50	–	–	0.020	–	–
FD	2.5			0.099		
FE	3.25			0.128		
SD	0.25	–	–	0.010	–	–
SE	0.25	–	–	0.010	–	–

Figure 9. LFBGA169 12 x 16 x 1.4 mm 132+21+16 3R14 0.50 mm, package outline

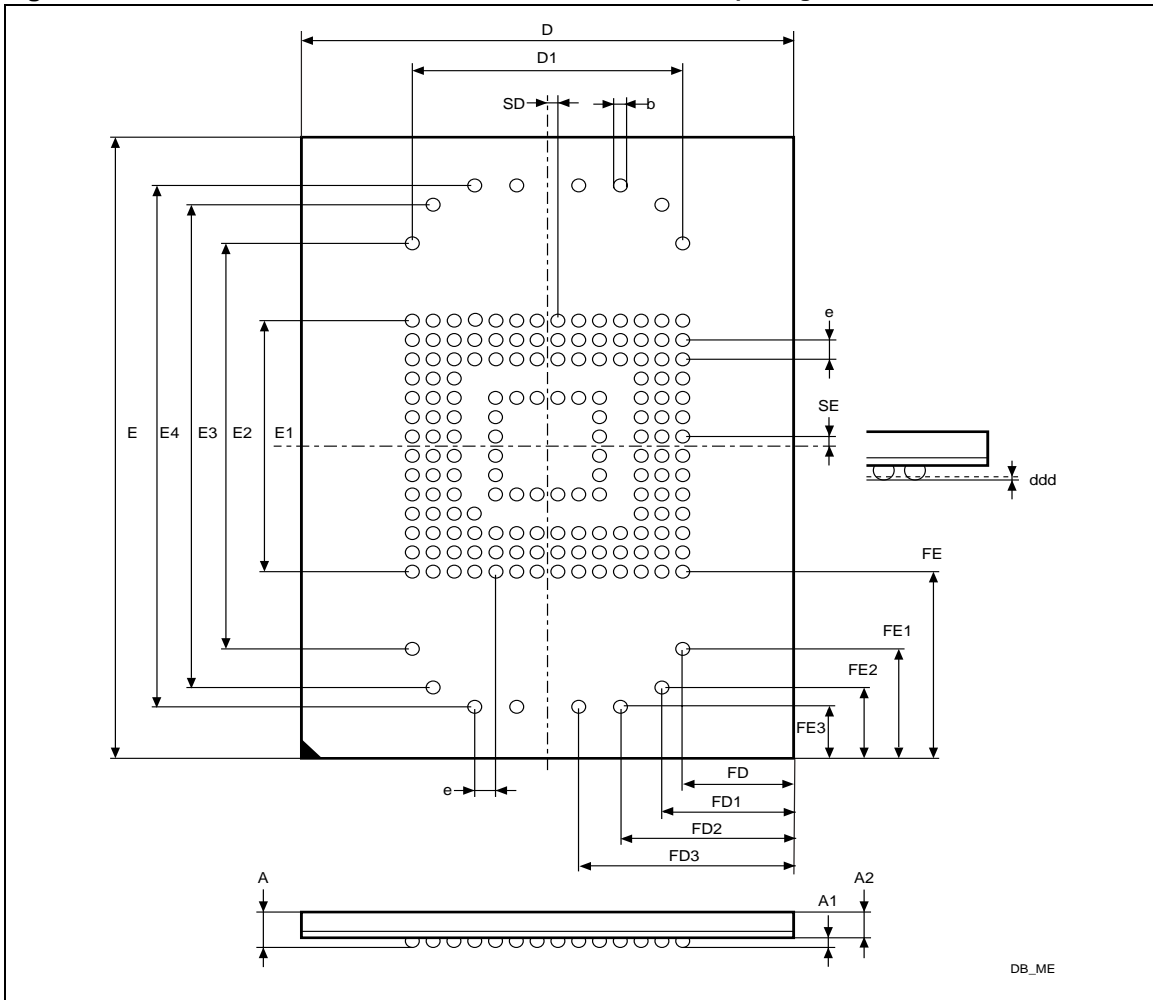

1. Drawing is not to scale.

Table 11. LFBGA169 12 x 16 x 1.4 mm 132+21+16 3R14 0.50 mm, mechanical data

Symbol	millimeters			inches		
	Typ	Min	Max	Typ	Min	Max
A			1.40			0.055
A1		0.15			0.006	
A2	1.00			0.039		
b	0.30	0.25	0.35	0.012	0.010	0.014
D	12.00	11.90	12.10	0.472	0.469	0.476
D1	6.50			0.256		
ddd			0.08			0.003
E	16.00	15.90	16.10	0.630	0.626	0.634
E1	6.50			0.256		
E2	10.50			0.413		
E3	12.50			0.492		
E4	13.50			0.531		
e	0.50	–	–	0.020	–	–
FD	2.75			0.108		
FD1	3.25			0.128		
FD2	4.25			0.167		
FD3	5.25			0.207		
FE	4.75			0.187		
FE1	2.75			0.108		
FE2	1.75			0.069		
FE3	1.25			0.049		
SD	0.25	–	–	0.010	–	–
SE	0.25	–	–	0.010	–	–

9 Ordering information

Table 12. Ordering information scheme

Example:	NAND08GAH	0	J	ZC	5	E
Device type NAND flash memory						
Density 08G = 1 Gbyte 16G = 2 Gbytes						
Operating voltage A = $V_{CC} = 3.3\text{ V}$, $V_{CCQ} = 1.8\text{ V}$ or 3.3 V						
Memory type H = eMMC						
Device options 0 = no option						
Product version H = version H (for 2-Gbyte devices) J = version J (for 1-Gbyte devices)						
Package ZC = LFBGA153 11.5 x 13 x 1.3 mm (only available for 1-Gbyte devices) ZA = LFBGA169 12 x 16 x 1.4 mm (only available for 2-Gbyte devices)						
Temperature range 5 = -25 to 85 °C						
Packing E = RoHS compliant package, standard packing F = RoHS compliant package, tape & reel packing						

Note: Other digits may be added to the ordering code for preprogrammed parts or other options. Devices are shipped from the factory with the memory content bits erased to '1'. For further information on any aspect of the device, please contact your nearest Numonyx sales office.

10 Revision history

Table 13. Document revision history

Date	Revision	Changes
25-Sep-2008	1	Initial release.
18-Nov-2008	2	Document's status promoted from target specification to preliminary data. Modified Table 3: Current consumption .
03-Dec-2008	3	Modified Table 12: Ordering information scheme . Minor text changes.
12-Jan-2009	4	Added silhouettes of packages on the cover page. Modified Figure 9: LFBGA169 12 x 16 x 1.4 mm 132+21+16 3R14 0.50 mm, package outline .
09-Feb-2009	5	Modified Figure 2: LFBGA153 package connections (top view through package) . Removed reference to ECOPACK packages.

Please Read Carefully:

INFORMATION IN THIS DOCUMENT IS PROVIDED IN CONNECTION WITH NUMONYX™ PRODUCTS. NO LICENSE, EXPRESS OR IMPLIED, BY ESTOPPEL OR OTHERWISE, TO ANY INTELLECTUAL PROPERTY RIGHTS IS GRANTED BY THIS DOCUMENT. EXCEPT AS PROVIDED IN NUMONYX'S TERMS AND CONDITIONS OF SALE FOR SUCH PRODUCTS, NUMONYX ASSUMES NO LIABILITY WHATSOEVER, AND NUMONYX DISCLAIMS ANY EXPRESS OR IMPLIED WARRANTY, RELATING TO SALE AND/OR USE OF NUMONYX PRODUCTS INCLUDING LIABILITY OR WARRANTIES RELATING TO FITNESS FOR A PARTICULAR PURPOSE, MERCHANTABILITY, OR INFRINGEMENT OF ANY PATENT, COPYRIGHT OR OTHER INTELLECTUAL PROPERTY RIGHT.

Numonyx products are not intended for use in medical, life saving, life sustaining, critical control or safety systems, or in nuclear facility applications.

Numonyx may make changes to specifications and product descriptions at any time, without notice.

Numonyx, B.V. may have patents or pending patent applications, trademarks, copyrights, or other intellectual property rights that relate to the presented subject matter. The furnishing of documents and other materials and information does not provide any license, express or implied, by estoppel or otherwise, to any such patents, trademarks, copyrights, or other intellectual property rights.

Designers must not rely on the absence or characteristics of any features or instructions marked "reserved" or "undefined." Numonyx reserves these for future definition and shall have no responsibility whatsoever for conflicts or incompatibilities arising from future changes to them.

Contact your local Numonyx sales office or your distributor to obtain the latest specifications and before placing your product order.

Copies of documents which have an order number and are referenced in this document, or other Numonyx literature may be obtained by visiting Numonyx's website at <http://www.numonyx.com>.

Numonyx StrataFlash is a trademark or registered trademark of Numonyx or its subsidiaries in the United States and other countries.

*Other names and brands may be claimed as the property of others.

Copyright © 11/5/7, Numonyx, B.V., All Rights Reserved.