

Audio Subsystem with Mono Class D Speaker and Class H Headphone Amplifier

General Description

The MAX97000 audio subsystem combines a mono speaker amplifier with a stereo headphone amplifier and an analog DPST switch. The headphone and speaker amplifiers have independent volume control and on/off control. The four inputs are configurable as two differential inputs or four single-ended inputs.

The entire subsystem is designed for maximum efficiency. The high-efficiency 725mW Class D speaker amplifier operates directly from the battery and consumes no more than 1 μ A in shutdown mode. The Class H headphone amplifier utilizes a dual-mode charge pump to maximize efficiency while outputting a ground-referenced signal that does not require output coupling capacitors.

The speaker amplifier incorporates a distortion limiter to automatically reduce the volume level when excessive clipping occurs. This allows high gain for low-level signals without compromising the quality of large signals.

All control is performed using the 2-wire, I²C interface. The MAX97000 operates in the extended -40°C to +85°C temperature range, and is available in the 2mm x 2mm, 25-bump WLP package (0.4mm pitch).

Applications

Cell Phones

Portable Multimedia Players

Features

- ◆ 1.6V to 2.0V Headphone Supply Voltage
- ◆ 2.7V to 5.5V Speaker Supply Voltage
- ◆ Internal LDO Allows Single-Supply Operation
- ◆ 725mW Speaker Output (V_{PVDD} = 3.7V, Z_{SPK} = 8 Ω + 68 μ H)
- ◆ 40mW/Channel Headphone Output (R_{HP} = 16 Ω)
- ◆ Low-Emission Class D Amplifier
- ◆ Efficient Class H Headphone Amplifier
- ◆ Ground-Referenced Headphone Outputs
- ◆ Two Stereo Single-Ended/Mono Differential Inputs
- ◆ Integrated Distortion Limiter (Speaker Outputs)
- ◆ Integrated DPST Analog Switch
- ◆ No Clicks and Pops
- ◆ TDMA Noise Free
- ◆ 2mm x 2mm, 25-Bump 0.4mm Pitch WLP Package

Ordering Information

PART	TEMP RANGE	PIN-PACKAGE
MAX97000EWA+	-40°C to +85°C	25 WLP

+Denotes a lead(Pb)-free/RoHS-compliant package.

Simplified Block Diagram

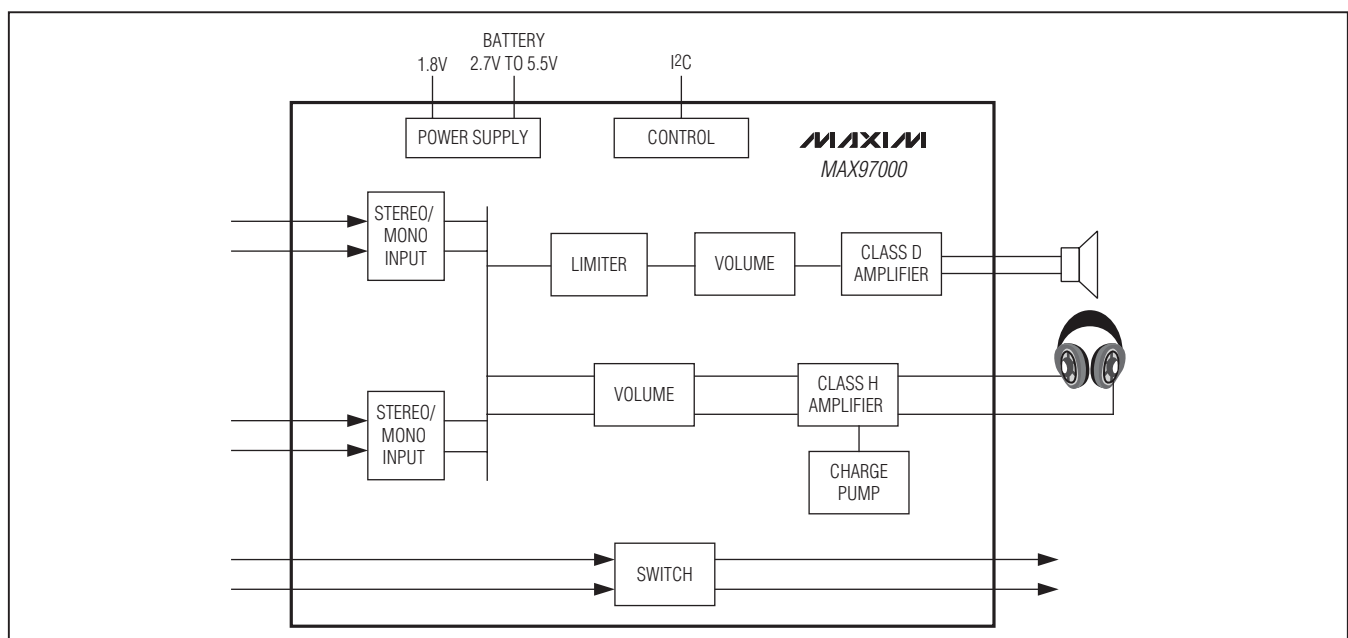

Audio Subsystem with Mono Class D Speaker and Class H Headphone Amplifier

TABLE OF CONTENTS

General Description	1
Applications	1
Features	1
Simplified Block Diagram	1
Ordering Information	1
Table of Contents	2
Functional Diagram/Typical Application Circuit	4
Absolute Maximum Ratings	5
Electrical Characteristics	5
Digital I/O Characteristics	9
I ² C Timing Characteristics	9
Typical Operating Characteristics	10
Pin Configuration	17
Pin Description	17
Detailed Description	18
Signal Path	18
Mixers	19
Class D Speaker Amplifier	19
Ultra-Low EMI Filterless Output Stage	20
Distortion Limiter	21
Analog Switch	21
Headphone Amplifier	21
DirectDrive	21
Charge Pump	22
Class H Operation	22
Low-Power Mode	22
I ² C Slave Address	22
I ² C Registers	23

Audio Subsystem with Mono Class D Speaker and Class H Headphone Amplifier

MAX97000

TABLE OF CONTENTS (CONTINUED)

Mixers	24
Volume Control	25
Distortion Limiter	27
Power Management	27
Charge-Pump Control	28
I ² C Serial Interface	28
Bit Transfer	28
START and STOP Conditions	28
Early STOP Conditions	28
Slave Address	28
Acknowledge	29
Write Data Format	29
Read Data Format	30
Applications Information	31
Filterless Class D Operation	31
RF Susceptibility	31
Component Selection	31
Optional Ferrite Bead Filter	31
Input Capacitor	31
Charge-Pump Capacitor Selection	32
Charge-Pump Flying Capacitor	32
Charge-Pump Holding Capacitor	32
Supply Bypassing, Layout, and Grounding	32
WLP Applications Information	32
Package Information	33
Revision History	34

Audio Subsystem with Mono Class D Speaker and Class H Headphone Amplifier

Functional Diagram/Typical Application Circuit

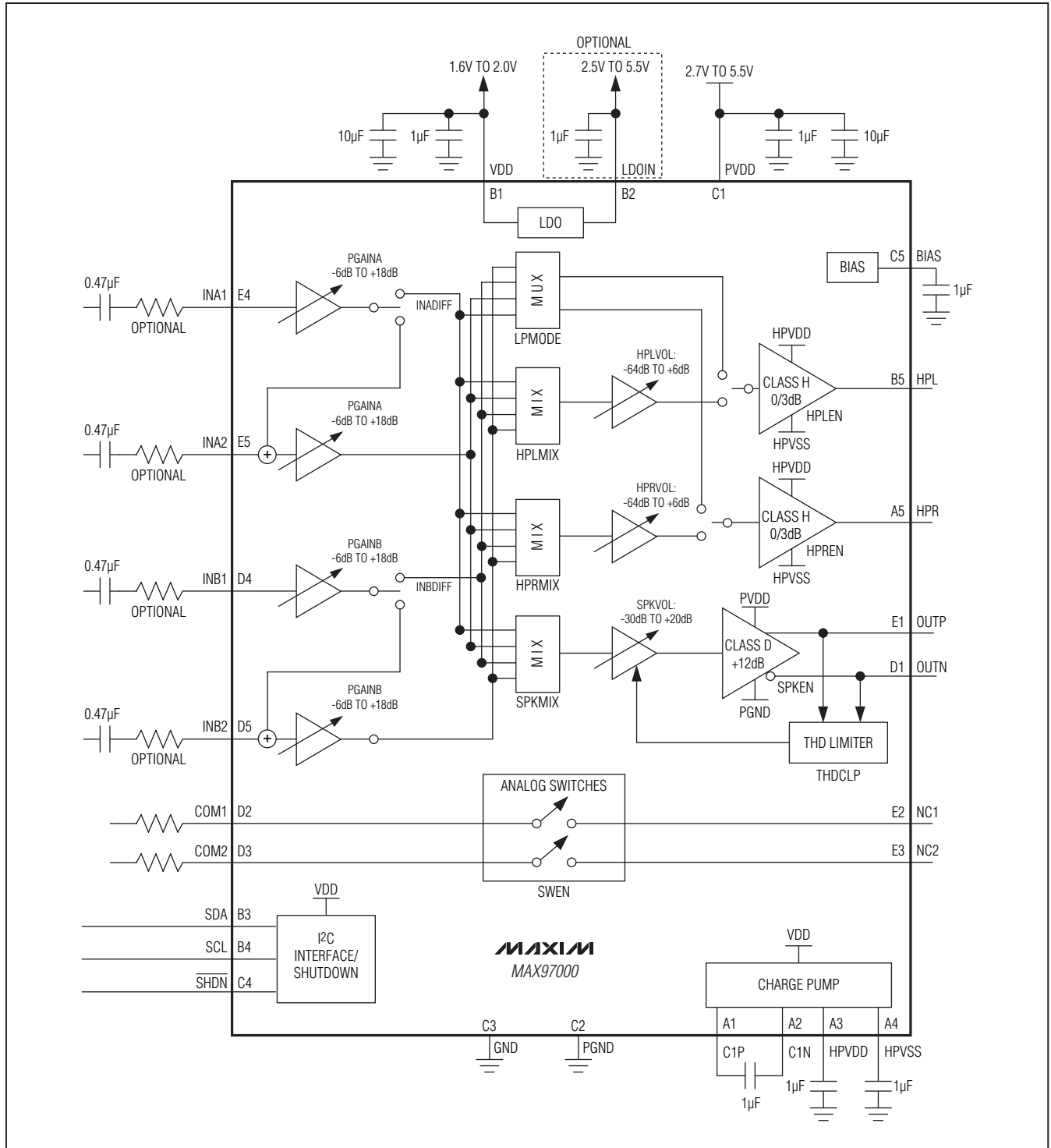

Audio Subsystem with Mono Class D Speaker and Class H Headphone Amplifier

MAX97000

ABSOLUTE MAXIMUM RATINGS

(Voltages with respect to GND.)

VDD, HPVDD	-0.3V to +2.2V
PVDD, LDOIN	-0.3V to +6.0V
PGND	-0.1V to +0.1V
HPVSS	-2.2V to +0.3V
C1N	(HPVSS - 0.3V) to (HPVDD + 0.3V)
C1P	-0.3V to (VDD + 0.3V)
HPL, HPR	(HPVSS - 0.3V) to (HPVDD + 0.3V)
INA1, INA2, INB1, INB2, BIAS	-0.3V to +6.0V
SDA, SCL, SHDN	-0.3V to +6.0V
COM1, COM2, NC1, NC2,	
OUTP, OUTN	-0.3V to (PVDD + 0.3V)
Continuous Current In/Out of PVDD, PGND, OUT_	±800mA
Continuous Current In/Out of HPR, HPL,	
VDD, LDOIN	±140mA

Continuous Current In/Out of COM1,	
COM2, NC1, NC2	±150mA
Continuous Input Current (all other pins)	±20mA
Duration of OUT_ Short Circuit to GND	
or PVDD	Continuous
Duration of Short Circuit Between OUTP	
and OUTN	Continuous
Duration of HP_ Short Circuit to GND or VDD	Continuous
Continuous Power Dissipation (TA = +70°C) Multilayer Board	
25 WLP (derate 19.2mW/°C above +70°C)	850mW
Junction Temperature	+150°C
Operating Temperature Range	-40°C to +85°C
Storage Temperature Range	-65°C to +150°C
Soldering Temperature (reflows)	+260°C

Stresses beyond those listed under "Absolute Maximum Ratings" may cause permanent damage to the device. These are stress ratings only, and functional operation of the device at these or any other conditions beyond those indicated in the operational sections of the specifications is not implied. Exposure to absolute maximum rating conditions for extended periods may affect device reliability.

ELECTRICAL CHARACTERISTICS

(VLDOIN = VPVDD = VSHDN = 3.7V, VGND = VPGND = 0V. Input signal applied at INA configured single-ended, preamp gain = 0dB, HPLVOL = HPRVOL = SPKVOL = 0dB, speaker loads (ZSPK) connected between OUTP and OUTN. Headphone loads (RHP) connected from HPL or HPR to GND. SDA and SCL pullup voltage = 1.8V. ZSPK = ∞, RHP = ∞. CC1P-C1N = CHPVDD = CHPVSS = CBIAS = 1μF. TA = TMIN to TMAX, unless otherwise noted. Typical values are at TA = +25°C.) (Note 1)

PARAMETER	SYMBOL	CONDITIONS	MIN	TYP	MAX	UNITS	
Speaker Amplifier Supply-Voltage Range	VPVDD	Guaranteed by PSRR test	2.7		5.5	V	
Headphone Amplifier Supply Voltage Range	VDD	Guaranteed by PSRR test	1.6		2	V	
LDO Input Supply-Voltage Range	VLDOIN	Guaranteed by PSRR test	2.5		5.5	V	
Quiescent Supply Current		Low-power mode, TA = +25°C, LPMODE = 0x01	ILDOIN	1.45	2	mA	
			IPVDD	0.4	0.7		
		HP mode, TA = +25°C, stereo SE input on INA, INB disabled	ILDOIN	1.45	2		
			IPVDD	0.79	1.2		
		SPK mode, TA = +25°C mono differential input on INB, INA disabled	ILDOIN	0.42	0.75		
			IPVDD	1.38	2.2		
Shutdown Current	ISHDN	TA = +25°C, internal gain, software	IPVDD	90	175	μA	
			ILDOIN	60	110		
		TA = +25°C, internal gain, IPVDD + ILDOIN, hardware			1		
Turn-On Time	tON	Time from power-on to full operation including soft-start		8		ms	
Input Resistance	RIN	TA = +25°C, internal gain	Gain = -6dB, -3dB	41.2		kΩ	
			Gain = 0dB to +9dB	16	20.6		27
			Gain = +18dB	5.5	7.2		9.5
Feedback Resistance	RF	TA = +25°C, external gain	19	20	21	kΩ	

Audio Subsystem with Mono Class D Speaker and Class H Headphone Amplifier

ELECTRICAL CHARACTERISTICS (continued)

(VLDOIN = VPVDD = VSHDN = 3.7V, VGND = VPGND = 0V. Input signal applied at INA configured single-ended, preamp gain = 0dB, HPLVOL = HPRVOL = SPKVOL = 0dB, speaker loads (ZSPK) connected between OUTP and OUTN. Headphone loads (RHP) connected from HPL or HPR to GND. SDA and SCL pullup voltage = 1.8V. ZSPK = ∞, RHP = ∞. CC1P-C1N = CHPVDD = CHPVSS = CBIAS = 1μF. TA = TMIN to TMAX, unless otherwise noted. Typical values are at TA = +25°C.) (Note 1)

PARAMETER	SYMBOL	CONDITIONS		MIN	TYP	MAX	UNITS
Maximum Input Signal Swing		Preamp = 0dB		2.3			VP-P
		Preamp = +18dB		0.29			
		Preamp = external gain		2.3 × RIN,EX/RF			
Common-Mode Rejection Ratio	CMRR	f = 1kHz (differential input mode)	Gain = 0dB	55			dB
			Gain = +18dB	32			
Input DC Voltage		IN_ inputs		1.125	1.2	1.275	V
Bias Voltage	VBIAS			1.13	1.2	1.27	V
SPEAKER AMPLIFIER							
Output Offset Voltage	VOS	TA = +25°C, SPKM = 1		±0.5	±4		mV
		TA = +25°C, SPKVOL = 0dB, SPKMIX = 0x01, IN_DIFF = 0V		±1.5			
Click-and-Pop Level	KCP	Peak voltage, TA = +25°C, A-weighted, 32 samples per second, volume at mute (Note 2)	Into shutdown	-70			dBV
			Out of shutdown	-70			
Power-Supply Rejection Ratio	PSRR	TA = +25°C (Note 2)	VPVDD = 2.7V to 5.5V	50	75		dB
			f = 217Hz, VRIPPLR = 200mVP-P	65			
			f = 1kHz, VRIPPLR = 200mVP-P	65			
			f = 20kHz, VRIPPLR = 200mVP-P	59			
Output Power		THD+N ≤ 1%, f = 1kHz, ZSPK = 8Ω + 68μH (Note 3)	VPVDD = 4.2V	930			mW
			VPVDD = 3.7V	725			
			VPVDD = 3.3V	562			
Total Harmonic Distortion + Noise	THD+N	f = 1kHz, POUT = 360mW, TA = +25°C, ZSPK = 8Ω + 68μH		0.05	0.6		%
Signal-to-Noise Ratio	SNR	A-weighted, SPKMIX = 0x03, referenced to 725mW	IN_DIFF = 0 (single-ended)	93			dB
			IN_DIFF = 1 (differential)	93			
Oscillator Frequency	fOSC			250			kHz
Spread-Spectrum Bandwidth				±20			kHz
Gain				11.5	12	12.5	dB
Current Limit				1.5			A
Efficiency	η	POUT = 725mW, f = 1kHz, ZSPK = 8Ω + 68μH		87			%
Output Noise		A-weighted, (SPKMIX = 0x01), IN_DIFF = 1, SPKVOL = 0dB		50			μVRMS

Audio Subsystem with Mono Class D Speaker and Class H Headphone Amplifier

MAX97000

ELECTRICAL CHARACTERISTICS (continued)

(VLDOIN = VPVDD = VSHDN = 3.7V, VGND = VPGND = 0V. Input signal applied at INA configured single-ended, preamp gain = 0dB, HPLVOL = HPRVOL = SPKVOL = 0dB, speaker loads (ZSPK) connected between OUTP and OUTN. Headphone loads (RHHP) connected from HPL or HPR to GND. SDA and SCL pullup voltage = 1.8V. ZSPK = ∞, RHHP = ∞. CC1P-C1N = CHPVDD = CHPVSS = CBIAS = 1μF. TA = TMIN to TMAX, unless otherwise noted. Typical values are at TA = +25°C.) (Note 1)

PARAMETER	SYMBOL	CONDITIONS	MIN	TYP	MAX	UNITS	
CHARGE PUMP							
Charge-Pump Frequency		VHPL = VHPR = 0V	80	83	85	kHz	
		VHPL = VHPR = 0.2V		665			
		VHPL = VHPR = 0.5V		500			
Positive Output Voltage	VHPVDD	VHPL, VHPR > VTH		1.8		V	
		VHPL, VHPR < VTH		0.9			
Negative Output Voltage	VHPVSS	VHPL, VHPR > VTH		-1.8		V	
		VHPL, VHPR < VTH		-0.9			
Headphone Output Voltage Threshold	VTH1	Output voltage at which the charge pump switches between fast and slow clock	0.1	0.16	0.21	V	
	VTH2	Output voltage at which the charge pump switches modes, VOUT rising or falling	0.40	0.46	0.52		
Mode Transition Timeouts		Time it takes for the charge pump to transition from invert to split mode		32		ms	
		Time it takes for the charge pump to transition from split to invert mode		20		μs	
HEADPHONE AMPLIFIERS							
Output Offset Voltage	VOS	TA = +25°C volume at mute		±0.15	±0.6	mV	
		TA = +25°C, HP_VOL = 0dB, HP_MIX = 0x1, IN_DIFF = 0		±0.5			
Click-and-Pop Level	KCP	Peak voltage, TA = +25°C, A-weighted, 32 samples per second, volume at mute (Note 2)	Into shutdown		-74	dBV	
			Out of shutdown		-74		
Power-Supply Rejection Ratio	PSRR	TA = +25°C (Note 2)	VLDOIN = 2.5V to 5.5V	70	85	dB	
			f = 217Hz, VRIPPLE = 200mVp-p		84		
			f = 1kHz, VRIPPLE = 200mVp-p		80		
			f = 20kHz, VRIPPLE = 200mVp-p		62		
Output Power	POUT	THD+N = 1%, f = 1kHz	RHP = 16Ω		40	mW	
			RHP = 32Ω		23		
			RHP = 32Ω, LPMODE = 1, LP gain = 3dB		34		
Channel-to-Channel Gain Tracking		TA = +25°C, HPL to HPR, volume at maximum, HPLMIX = 0x01, HPRMIX = 0x02, IN_DIFF = 0		±0.3	±2.5	%	

Audio Subsystem with Mono Class D Speaker and Class H Headphone Amplifier

ELECTRICAL CHARACTERISTICS (continued)

(VLDI0IN = VPVDD = VSHDN = 3.7V, VGND = VPGND = 0V. Input signal applied at INA configured single-ended, preamp gain = 0dB, HPLVOL = HPRVOL = SPKVOL = 0dB, speaker loads (ZSPK) connected between OUTP and OUTN. Headphone loads (RHP) connected from HPL or HPR to GND. SDA and SCL pullup voltage = 1.8V. ZSPK = ∞, RHP = ∞. CC1P-C1N = CHPVDD = CHPVSS = CBIAS = 1μF. TA = TMIN to TMAX, unless otherwise noted. Typical values are at TA = +25°C.) (Note 1)

PARAMETER	SYMBOL	CONDITIONS		MIN	TYP	MAX	UNITS
Total Harmonic Distortion + Noise	THD+N	POUT = 10mW, f = 1kHz	RHP = 32Ω		0.02		%
			RHP = 16Ω		0.03	0.1	
Signal-to-Noise Ratio	SNR	A-weighted, RHP = 16Ω, HPLMIX = 0x01, HPRMIX = 0x02, IN_DIFF = 0			100		dB
Slew Rate	SR				0.35		V/μs
Capacitive Drive	CL				200		pF
Crosstalk		HPL to HPR, HPR to HPL, f = 20Hz to 20kHz			65		dB
ANALOG SWITCH							
On-Resistance	RON	INC_ = 20mA, VCOM_ = 0V and PVDD, SWEN = 1	TA = +25°C		1.6	4	Ω
			TA = TMIN to TMAX			5.2	
Total Harmonic Distortion + Noise		VDIFCOM_ = 2Vp-p, VCMCOM_ = PVDD/2, f = 1kHz, SWEN = 1, ZSPK = 8Ω + 68μH	10Ω in series with each switch		0.05		%
			No series resistors		0.3		
Off-Isolation		SWEN = 0, COM1 and COM2 to GND = 50Ω, f = 10kHz, referred to signal applied to NC1 and NC2			105		dB
PREAMPLIFIER							
Gain		PGAIN_ = 000		-6.5	-6	-5.5	dB
		PGAIN_ = 001		-3.5	-3	-2.5	
		PGAIN_ = 010		-0.5	0	0.5	
		PGAIN_ = 011		2.5	3	3.5	
		PGAIN_ = 100		5.5	6	6.5	
		PGAIN_ = 101		8.5	9	9.5	
		PGAIN_ = 110		17.5	18	18.5	
VOLUME CONTROL							
Volume Level		HP_VOL = 0x1F		5.5	6	6.5	dB
		HP_VOL = 0x00		-68	-64	-60	
		SPKVOL = 0x3F		19	20	21	
		SPKVOL = 0x00		-31	-30	-29	
Mute Attenuation		f = 1kHz	Speaker		109		dB
			Headphone		101		
Zero-Crossing Detection Timeout					100		ms
LIMITER							
Attack Time					1		ms
Release Time Constant		THDT1 = 0			1.4		s
		THDT1 = 1			2.8		

Audio Subsystem with Mono Class D Speaker and Class H Headphone Amplifier

MAX97000

DIGITAL I/O CHARACTERISTICS

(VLDOIN = VPVDD = VSHDN = 3.7V, VGND = VPGND = 0V. TA = TMIN to TMAX, unless otherwise noted. Typical values are at TA = +25°C.) (Note 1)

PARAMETER	SYMBOL	CONDITIONS	MIN	TYP	MAX	UNITS
DIGITAL INPUTS (SDA, SCL, SHDN)						
Input Voltage High	VIH		1.3			V
Input Voltage Low	VIL				0.5	V
Input Hysteresis	VHYS			200		mV
Input Capacitance	CIN			10		pF
Input Leakage Current	IIN	TA = +25°C			±1.0	µA
		VLDOIN = 0, TA = +25°C			±1.0	
DIGITAL OUTPUTS (SDA Open Drain)						
Output Low Voltage	VOL	ISINK = 3mA			0.4	V

I²C TIMING CHARACTERISTICS

(VLDOIN = VPVDD = VSHDN = 3.7V, VGND = VPGND = 0V. TA = TMIN to TMAX, unless otherwise noted. Typical values are at TA = +25°C.) (Note 1)

PARAMETER	SYMBOL	CONDITIONS	MIN	TYP	MAX	UNITS
Serial-Clock Frequency	fSCL		0		400	kHz
Bus Free Time Between STOP and START Conditions	tBUF		1.3			µs
Hold Time (Repeated) START Condition	tHD,STA		0.6			µs
SCL Pulse-Width Low	tLOW		1.3			µs
SCL Pulse-Width High	tHIGH		0.6			µs
Setup Time for a Repeated START Condition	tSU,STA		0.6			µs
Data Hold Time	tHD,DAT		0		900	ns
Data Setup Time	tSU,DAT		100			ns
SDA and SCL Receiving Rise Time	tR	(Note 4)	20 + 0.1CB		300	ns
SDA and SCL Receiving Fall Time	tF	(Note 4)	20 + 0.1CB		300	ns
SDA Transmitting Fall Time	tF	(Note 4)	20 + 0.1CB		300	ns
Setup Time for STOP Condition	tSU,STO		0.6			µs
Bus Capacitance	CB				400	pF
Pulse Width of Suppressed Spike	tSP		0		50	ns

Note 1: 100% production tested at TA = +25°C. Specifications overtemperature limits are guaranteed by design.

Note 2: Amplifier inputs are AC-coupled to GND.

Note 3: Class D amplifier testing performed with a resistive load in series with an inductor to simulate an actual speaker load.

Note 4: CB is in pF.

Audio Subsystem with Mono Class D Speaker and Class H Headphone Amplifier

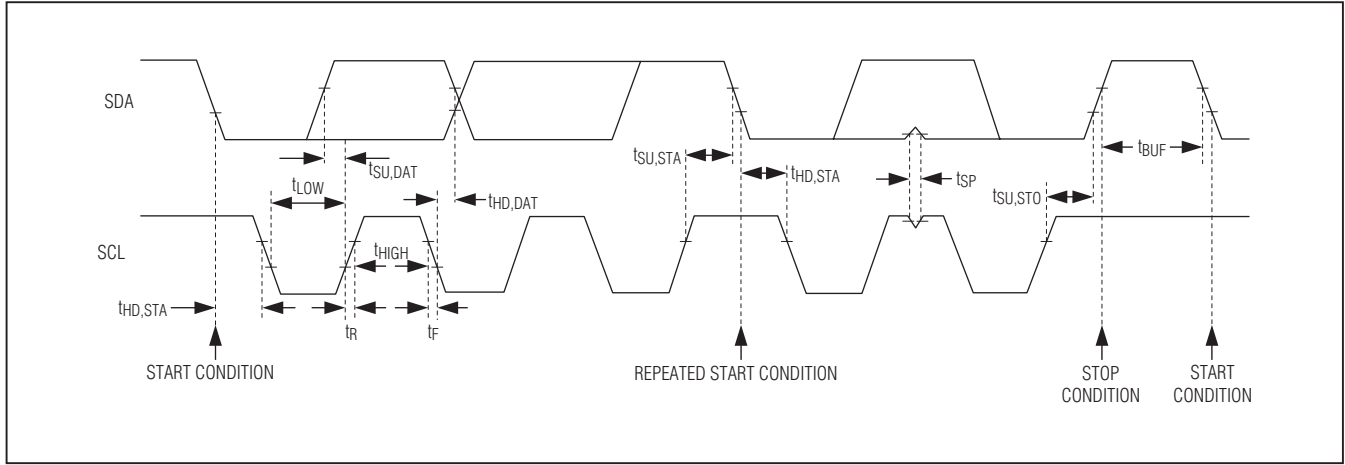
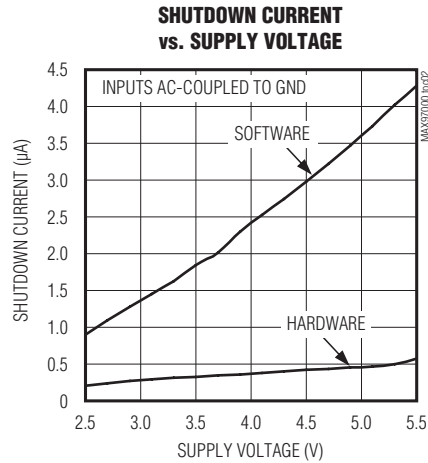
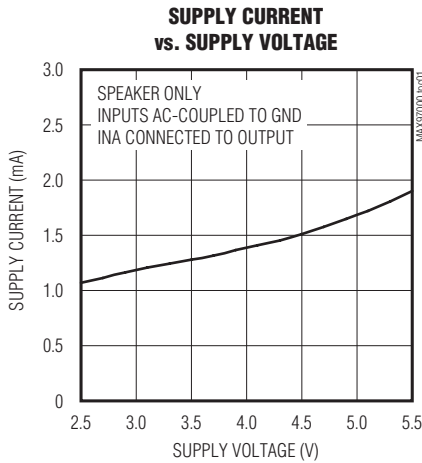

Figure 1. I2C Interface Timing Diagram

Typical Operating Characteristics

($V_{LDOIN} = V_{PVD} = 3.7V$, $V_{GND} = V_{PGND} = 0V$. Single-ended inputs, preamp gain = 0dB, HPLVOL = HPRVOL = SPKVOL = 0dB. Speaker loads (Z_{SPK}) connected between OUTP and OUTN. Headphone loads (R_{HP}) connected from HPL or HPR to GND. $Z_{SPK} = \infty$, $R_{HP} = \infty$. $C_{C1P-C1N} = C_{HPVDD} = C_{HPVSS} = C_{BIAS} = 1\mu F$. $T_A = +25^\circ C$, unless otherwise noted.)

GENERAL



Audio Subsystem with Mono Class D Speaker and Class H Headphone Amplifier

Typical Operating Characteristics (continued)

(VLDOIN = VPVDD = 3.7V, VGND = VPGND = 0V. Single-ended inputs, preamp gain = 0dB, HPLVOL = HPRVOL = SPKVOL = 0dB. Speaker loads (ZSPK) connected between OUTP and OUTN. Headphone loads (RH_P) connected from HPL or HPR to GND. ZSPK = ∞, RH_P = ∞. CC1P-C1N = CHPVDD = CHPVSS = CBIAS = 1μF. T_A = +25°C, unless otherwise noted.)

MAX97000

SPEAKER AMPLIFIER

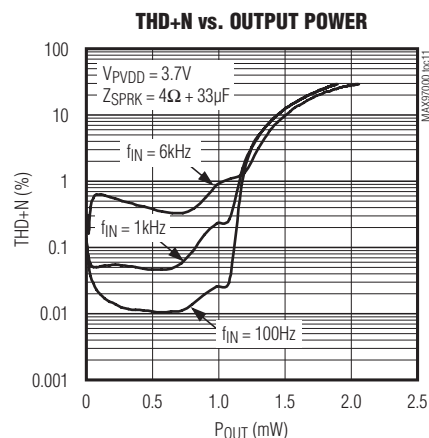
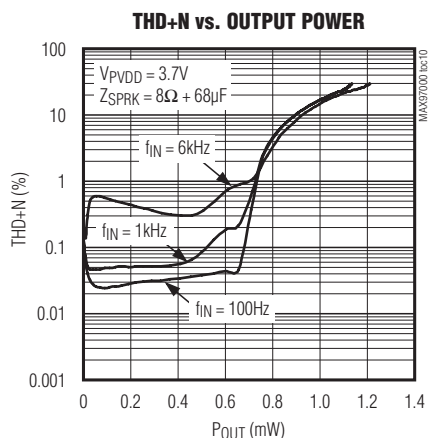
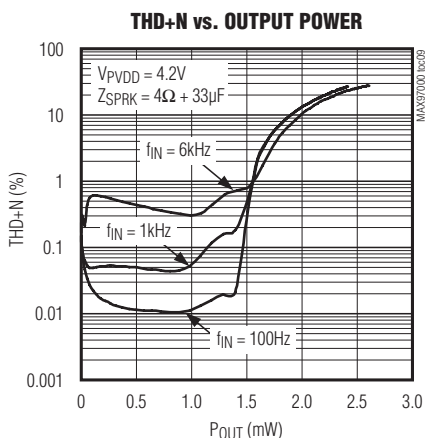
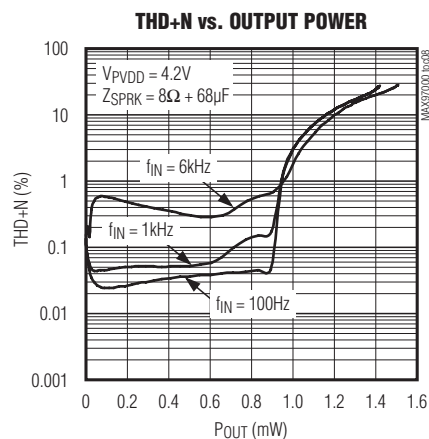
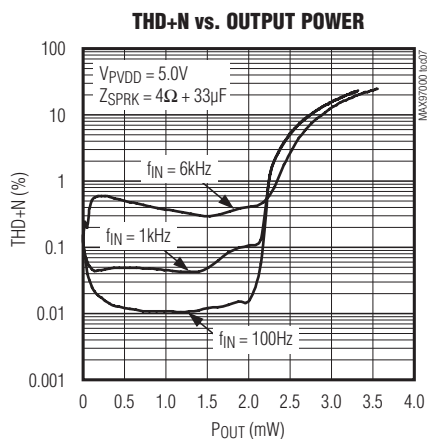
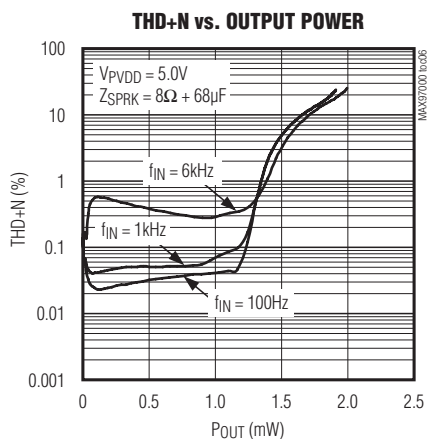
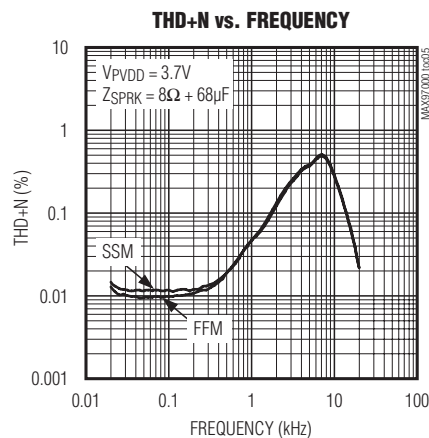
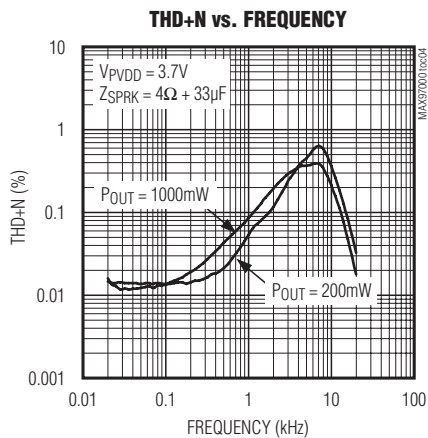
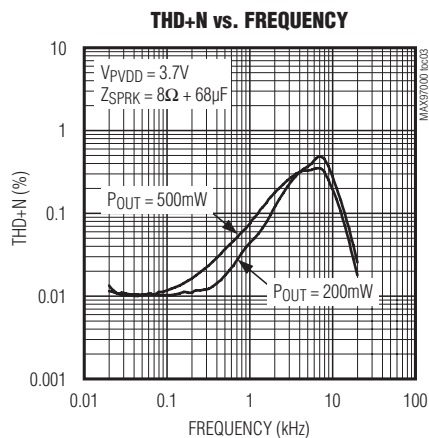

Audio Subsystem with Mono Class D Speaker and Class H Headphone Amplifier

Typical Operating Characteristics (continued)

(VLDOIN = VPVDD = 3.7V, VGND = VPGND = 0V. Single-ended inputs, preamp gain = 0dB, HPLVOL = HPRVOL = SPKVOL = 0dB. Speaker loads (ZSPK) connected between OUTP and OUTN. Headphone loads (RHHP) connected from HPL or HPR to GND. ZSPK = ∞, RHHP = ∞. CC1P-C1N = CHPVDD = CHPVSS = CBIAS = 1μF. TA = +25°C, unless otherwise noted.)

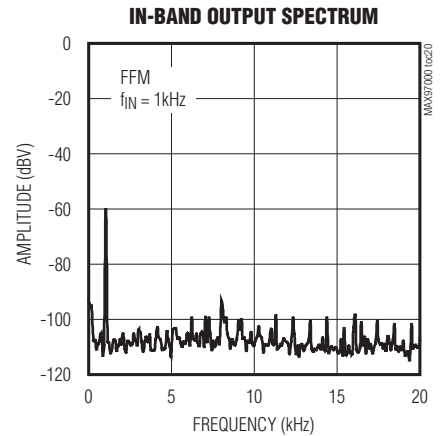
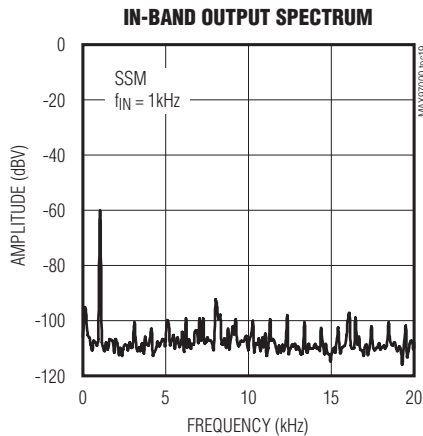
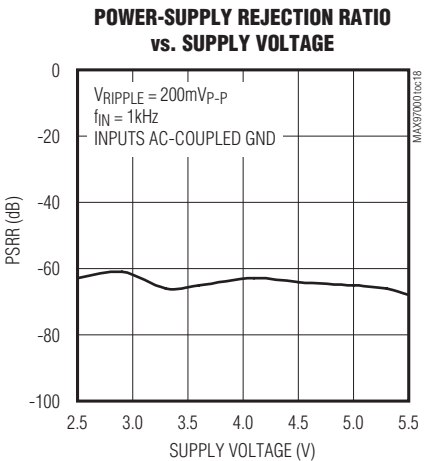
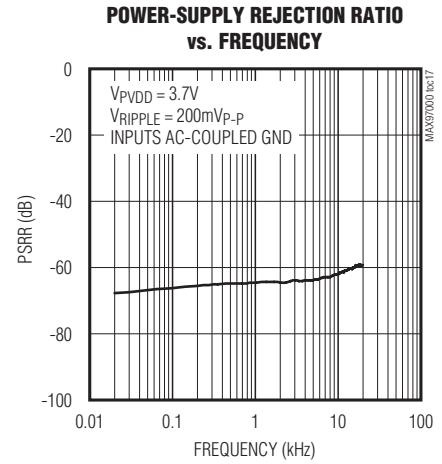
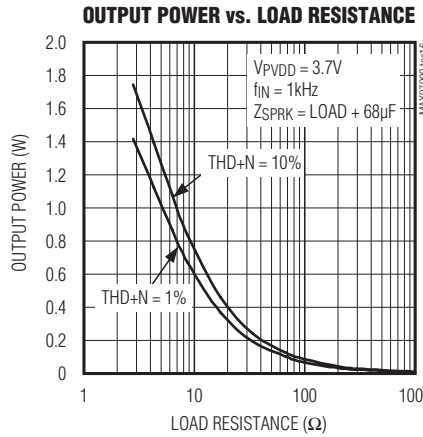
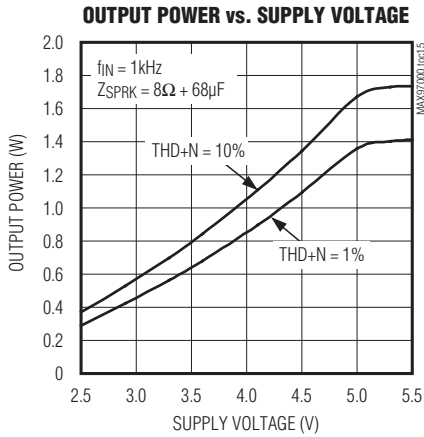
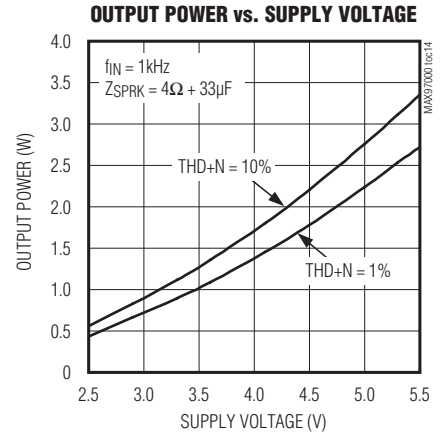
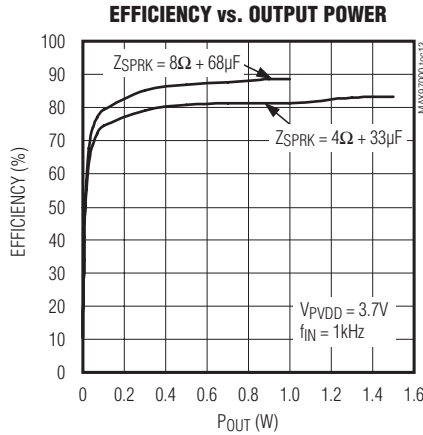
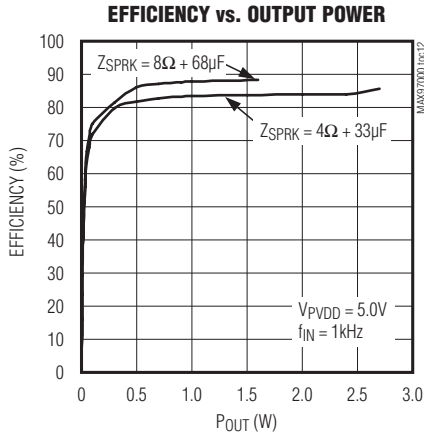

Audio Subsystem with Mono Class D Speaker and Class H Headphone Amplifier

MAX97000

Typical Operating Characteristics (continued)

(VLDOIN = VPVDD = 3.7V, VGND = VPGND = 0V. Single-ended inputs, preamp gain = 0dB, HPLVOL = HPRVOL = SPKVOL = 0dB. Speaker loads (ZSPK) connected between OUTP and OUTN. Headphone loads (RHP) connected from HPL or HPR to GND. ZSPK = ∞, RHP = ∞. CC1P-C1N = CHPVDD = CHPVSS = CBIAS = 1μF. TA = +25°C, unless otherwise noted.)

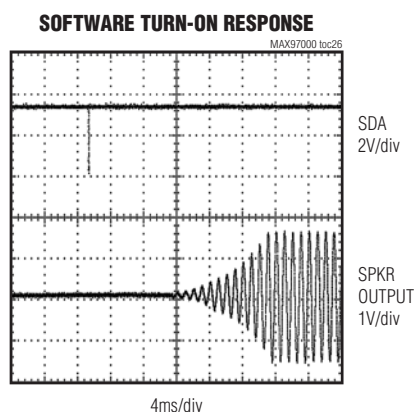
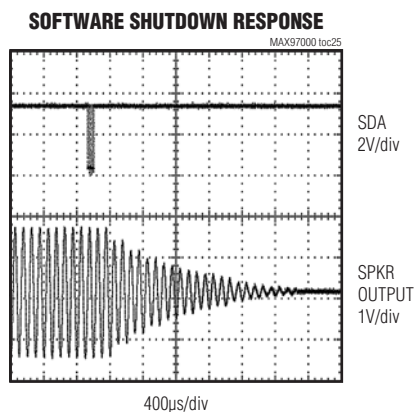
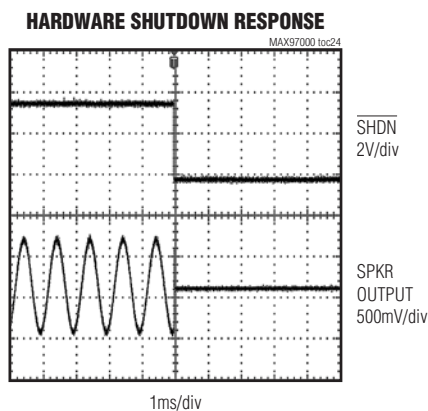
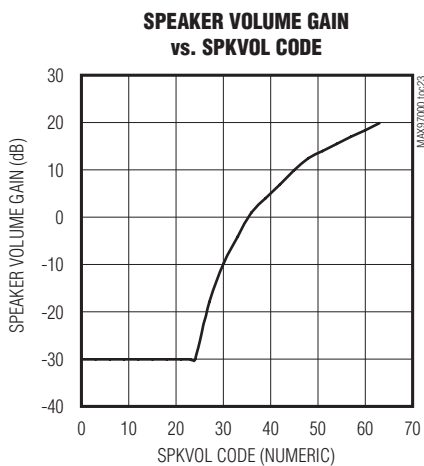
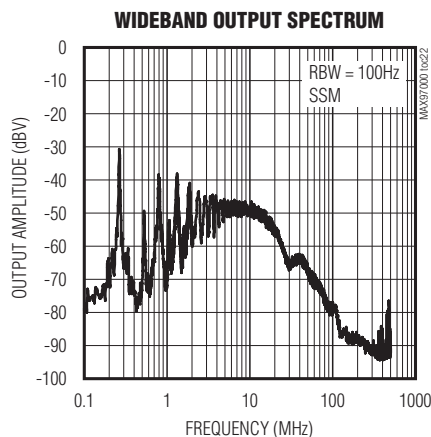
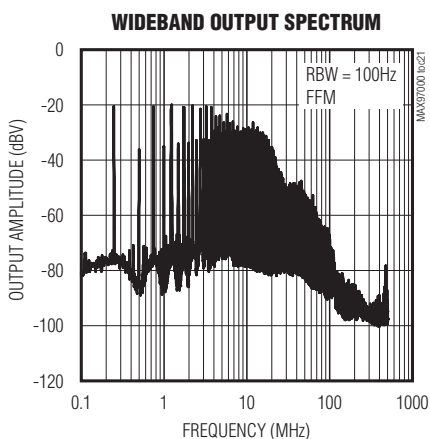

Audio Subsystem with Mono Class D Speaker and Class H Headphone Amplifier

Typical Operating Characteristics (continued)

($V_{LDOIN} = V_{PDD} = 3.7V$, $V_{GND} = V_{PND} = 0V$. Single-ended inputs, preamp gain = 0dB, HPLVOL = HPRVOL = SPKVOL = 0dB. Speaker loads (Z_{SPK}) connected between OUTP and OUTN. Headphone loads (R_{HP}) connected from HPL or HPR to GND. $Z_{SPK} = \infty$, $R_{HP} = \infty$. CC1P-C1N = CHPVDD = CHPVSS = CBIAS = $1\mu F$. $T_A = +25^\circ C$, unless otherwise noted.)

HEADPHONE AMPLIFIER

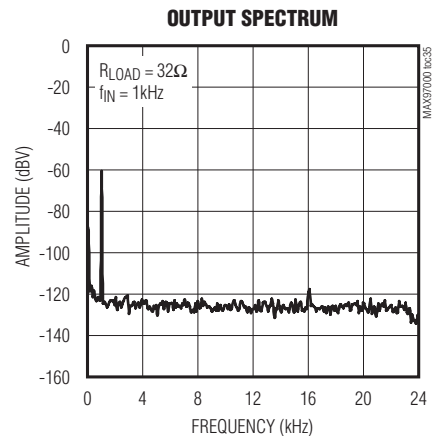
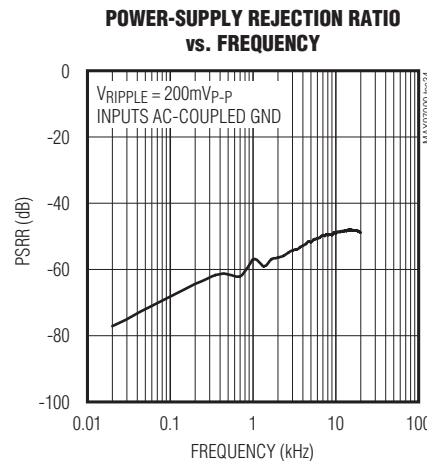
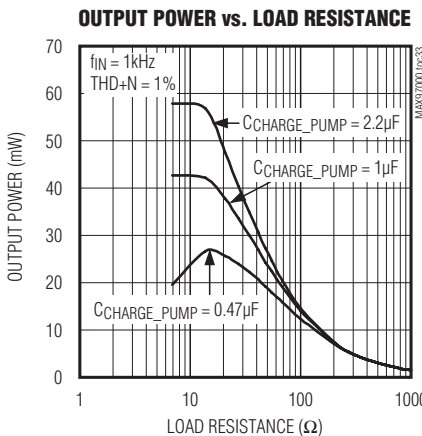
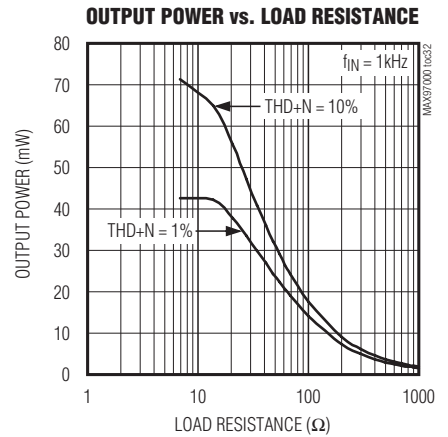
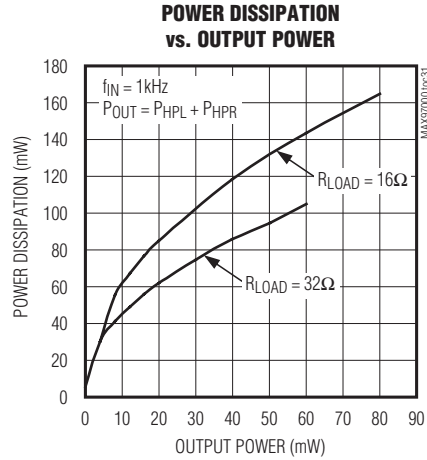
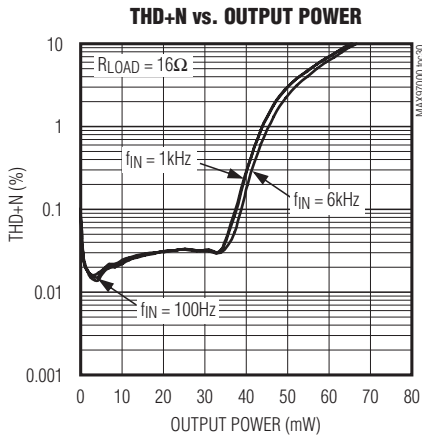
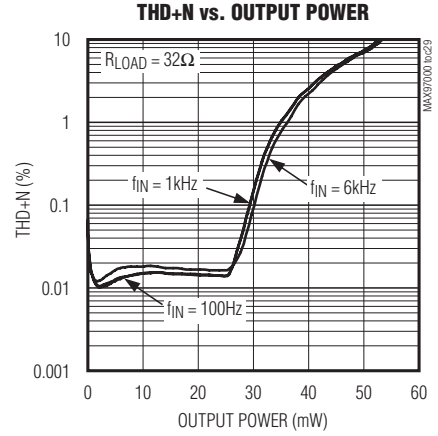
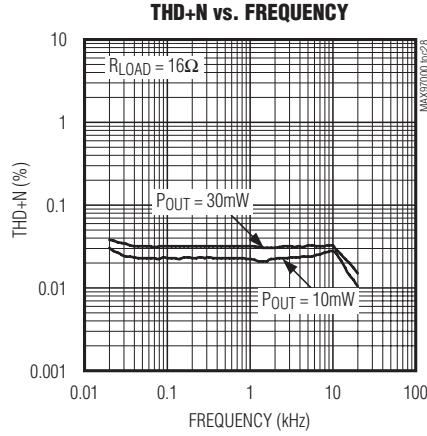
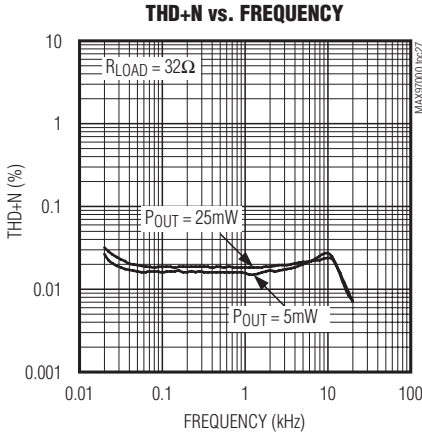

Audio Subsystem with Mono Class D Speaker and Class H Headphone Amplifier

MAX97000

Typical Operating Characteristics (continued)

($V_{LDOIN} = V_{PDD} = 3.7V$, $V_{GND} = V_{PGND} = 0V$. Single-ended inputs, preamp gain = 0dB, HPLVOL = HPRVOL = SPKVOL = 0dB. Speaker loads (ZSPK) connected between OUTP and OUTN. Headphone loads (R_{HP}) connected from HPL or HPR to GND. $Z_{SPK} = \infty$, $R_{HP} = \infty$. $C_{C1P-C1N} = C_{HPVDD} = C_{HPVSS} = C_{BIAS} = 1\mu F$. $T_A = +25^\circ C$, unless otherwise noted.)

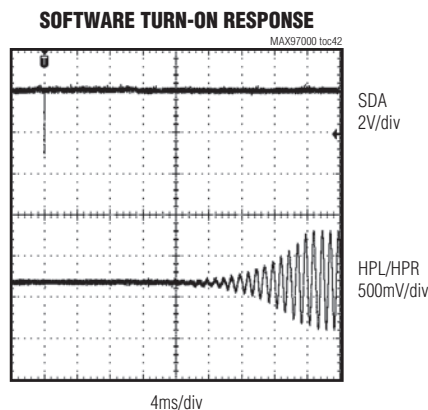
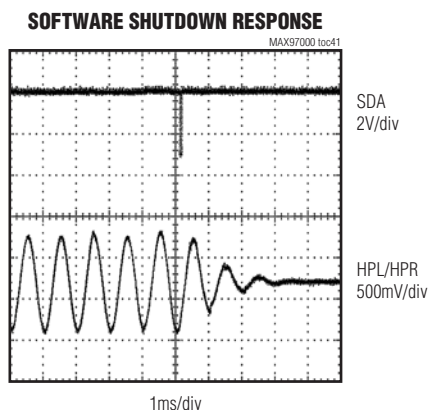
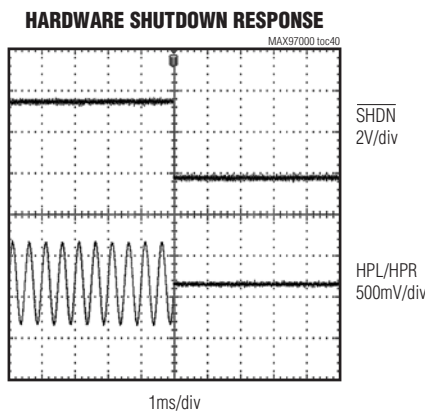
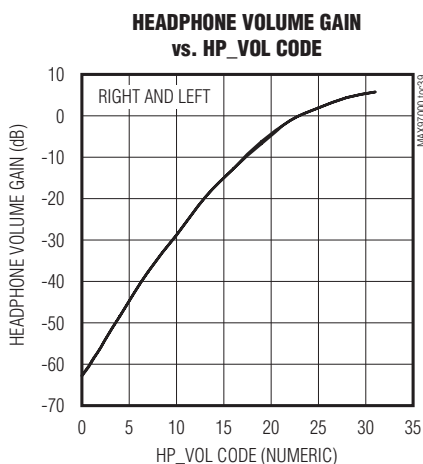
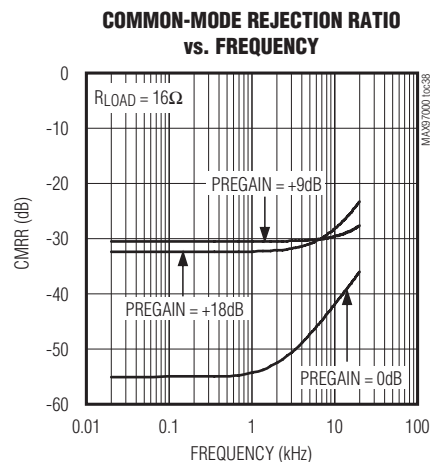
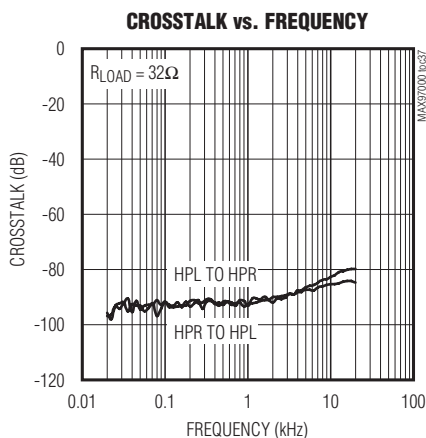
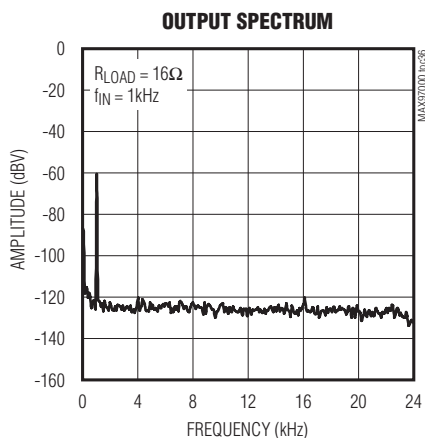

Audio Subsystem with Mono Class D Speaker and Class H Headphone Amplifier

Typical Operating Characteristics (continued)

(VLDOIN = VPVDD = 3.7V, VGND = VPGND = 0V. Single-ended inputs, preamp gain = 0dB, HPLVOL = HPRVOL = SPKVOL = 0dB. Speaker loads (ZSPK) connected between OUTP and OUTN. Headphone loads (RHP) connected from HPL or HPR to GND. ZSPK = ∞, RHP = ∞. CC1P-C1N = CHPVDD = CHPVSS = CBIAS = 1μF. TA = +25°C, unless otherwise noted.)

ANALOG SWITCH

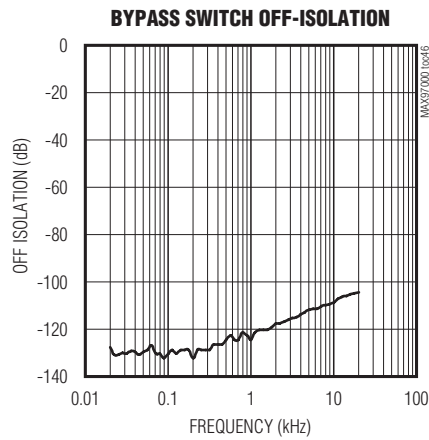
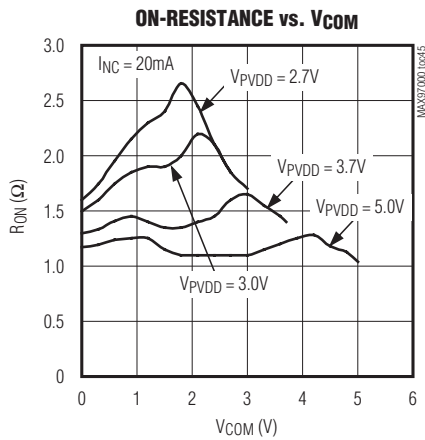
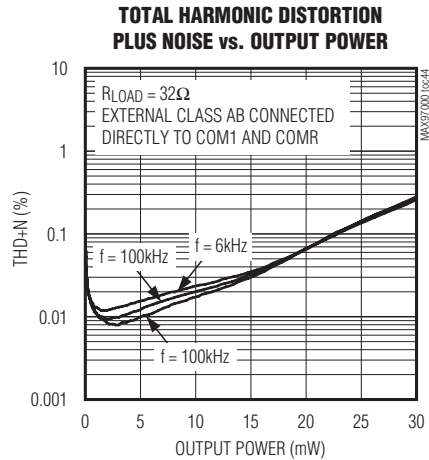
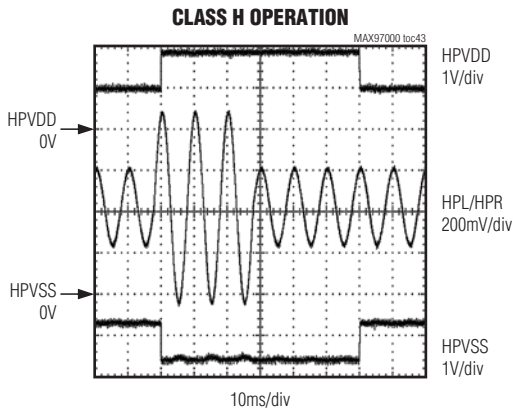

Audio Subsystem with Mono Class D Speaker and Class H Headphone Amplifier

Pin Configuration

MAX97000

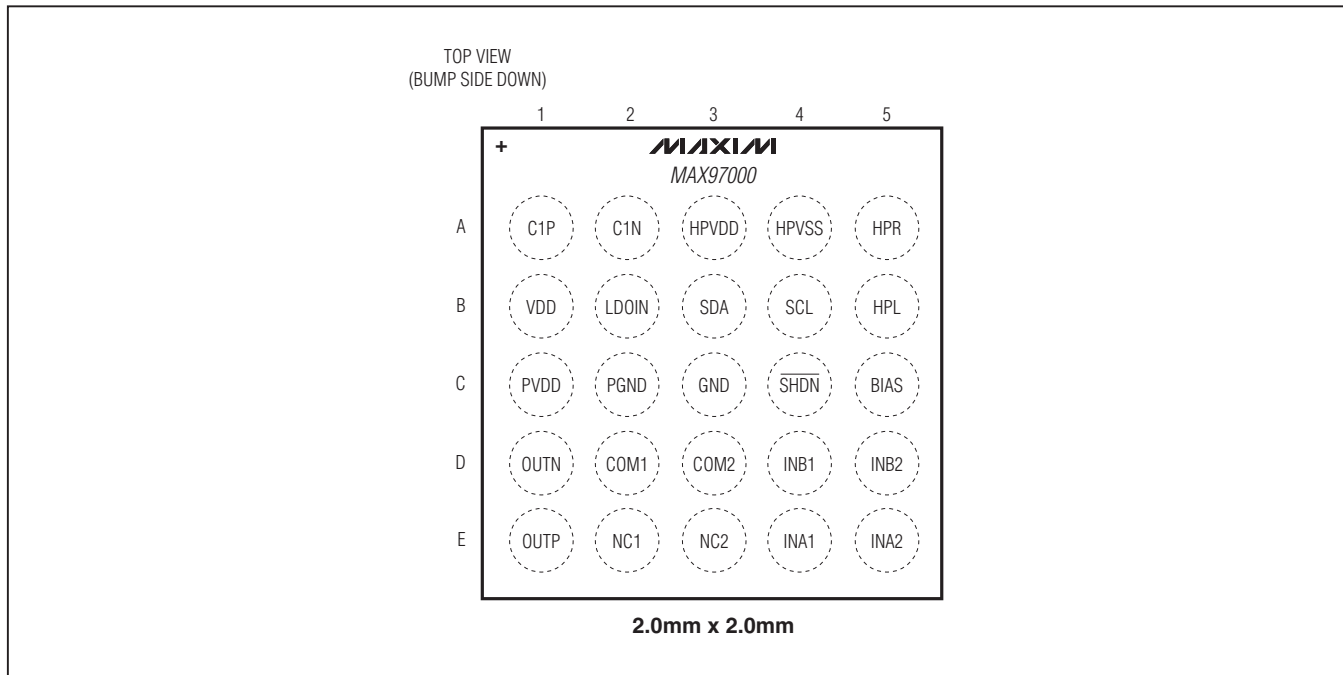

Pin Description

BUMP	NAME	FUNCTION
A1	C1P	Charge-Pump Flying Capacitor Positive Terminal. Connect a 1 μ F capacitor between C1P and C1N.
A2	C1N	Charge-Pump Flying Capacitor Negative Terminal. Connect a 1 μ F capacitor between C1P and C1N.
A3	HPVDD	Headphone Amplifier Positive Power Supply. Bypass with a 1 μ F capacitor to PGND.
A4	HPVSS	Headphone Amplifier Negative Power Supply. Bypass with a 1 μ F capacitor to PGND.
A5	HPR	Headphone Amplifier Right Output
B1	VDD	LDO Output and Headphone Amplifier Supply. Bypass with a 1 μ F and a 10 μ F capacitor to GND. Power VDD or LDOIN. When powering VDD, leave LDOIN unconnected.
B2	LDOIN	LDO Input. Generates VDD if no 1.8V power supply is available. Leave unconnected to disable. Do not power VDD when powering LDOIN.
B3	SDA	Serial Data Input/Output. Connect a pullup resistor from SDA to the I ² C bus supply.
B4	SCL	Serial-Clock Input. Connect a pullup resistor from SCL to the I ² C bus supply.
B5	HPL	Headphone Amplifier Left Output
C1	PVDD	Class D Power Supply. Bypass with a 1 μ F and a 10 μ F capacitor to PGND.
C2	PGND	Class D Power Ground and Charge Pump Ground
C3	GND	Analog Ground.
C4	$\overline{\text{SHDN}}$	Active-Low Shutdown
C5	BIAS	Common-Mode Bias. Bypass to GND with a 1 μ F capacitor.

Audio Subsystem with Mono Class D Speaker and Class H Headphone Amplifier

Pin Description (continued)

BUMP	NAME	FUNCTION
D1	OUTN	Negative Speaker Output
D2	COM1	Analog Switch 1 Input
D3	COM2	Analog Switch 2 Input
D4	INB1	Input B1. Left or negative input.
D5	INB2	Input B2. Right or positive input.
E1	OUTP	Positive Speaker Output
E2	NC1	Analog Switch 1 Output
E3	NC2	Analog Switch 2 Output
E4	INA1	Input A1. Left or negative input.
E5	INA2	Input A2. Right or positive input.

Detailed Description

The MAX97000 audio subsystem combines a mono speaker amplifier with a stereo headphone amplifier and an analog DPST switch. The high-efficiency 725mW Class D speaker amplifier operates directly from the battery and consumes no more than 1 μ A when in shutdown mode. The headphone amplifier utilizes a dual-mode charge pump and a Class H output stage to maximize efficiency while outputting a ground-referenced signal that does not require output coupling capacitors. The headphone and speaker amplifiers have independent volume control and on/off control. The four inputs are configurable as two differential inputs or four single-ended inputs. All control is performed using the 2-wire, I²C interface.

The speaker amplifier incorporates a distortion limiter to automatically reduce the volume level when excessive clipping occurs. This allows high gain for low-level signals without compromising the quality of large signals.

Internal Linear Regulator

The MAX97000 includes an internal regulator (LDOIN) to generate VDD in cases where no 1.8V supply is available. Using the regulator allows single-supply operation directly from a Li+ battery. To enable the internal regulator apply a power supply to LDOIN and do not connect power to VDD. When not using the internal regulator, leave LDOIN unconnected and power VDD from a 1.8V supply.

Signal Path

The MAX97000 signal path consists of flexible inputs, signal mixing, volume control, and output amplifiers (Figure 2). The inputs can be configured for single-ended or differential signals (Figure 3). The internal preamplifiers feature programmable gain settings using internal resistors and an external gain setting using a trimmed internal feedback resistor. The external option allows any desired gain to be selected. Following preamplification, the input signals are mixed, volume adjusted, and routed to the headphone and speaker amplifiers based on the desired configuration.

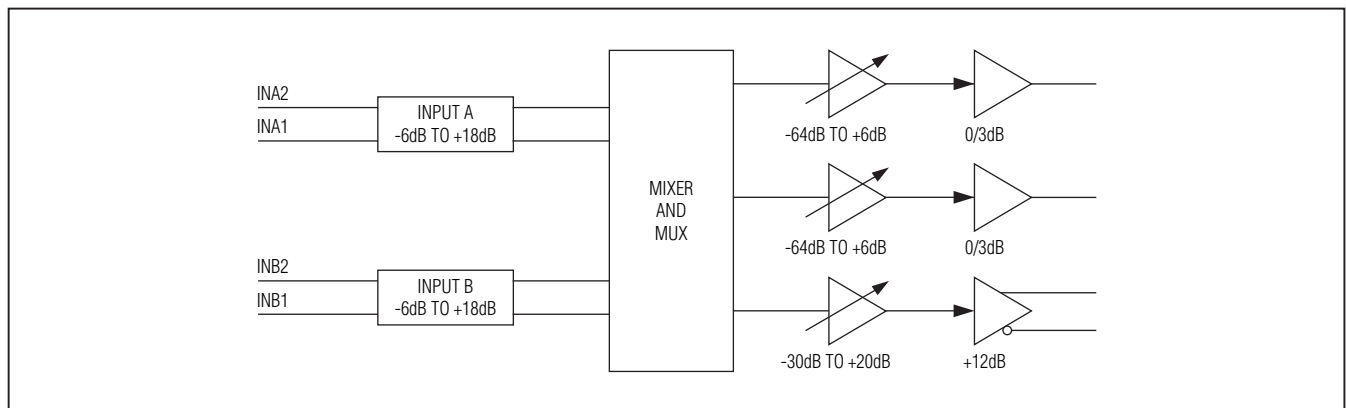

Figure 2. Signal Path

Audio Subsystem with Mono Class D Speaker and Class H Headphone Amplifier

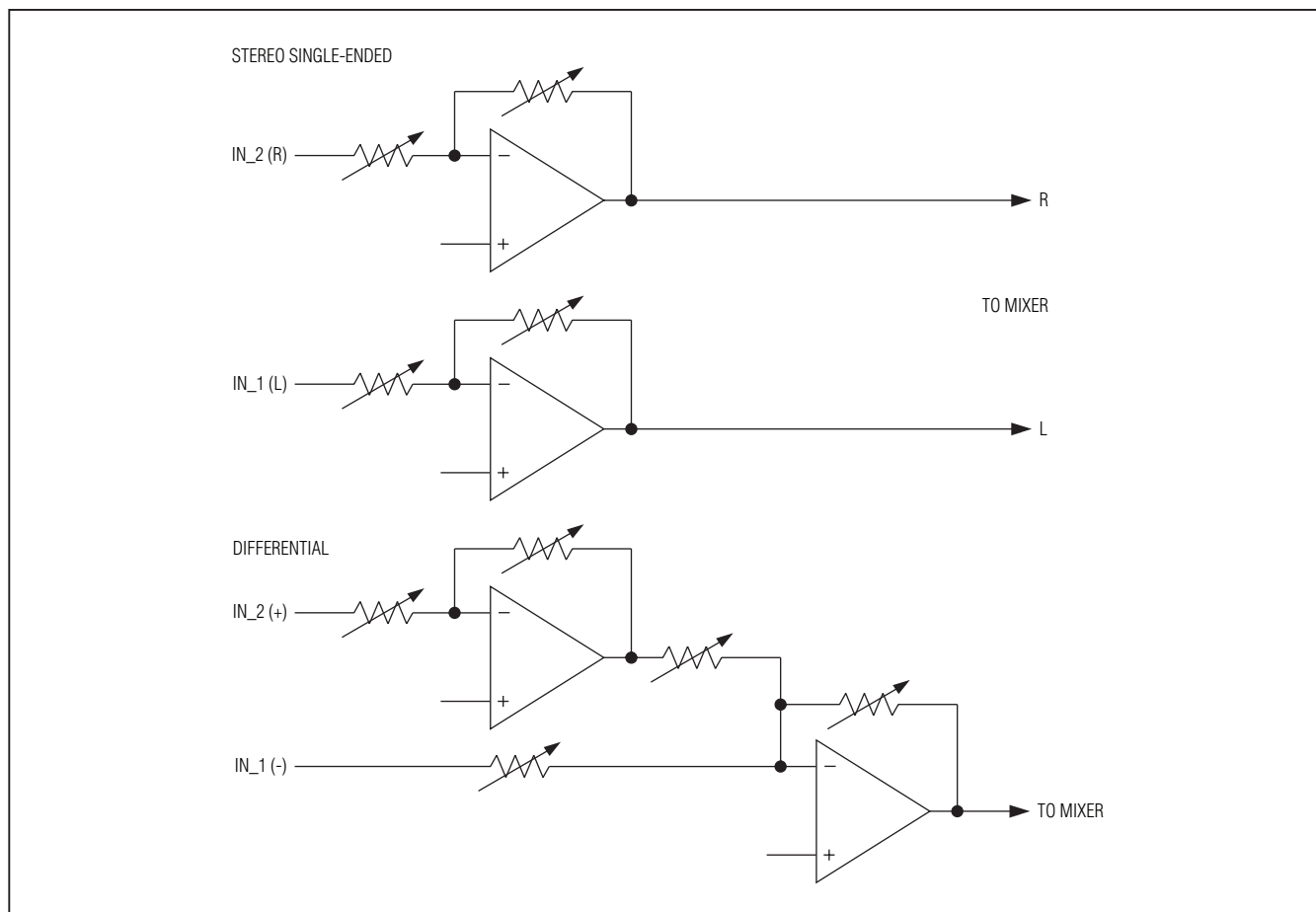

Figure 3. Differential and Stereo Single-Ended Input Configurations

Mixers

The MAX97000 features independent mixers for the left headphone, right headphone, and speaker paths. Each output can select any combination of any inputs. This allows for mixing two audio signals together and routing independent signals to the headphone and speaker amplifiers. If one of the inputs is not selected by either mixer, it is automatically powered down to save power.

Class D Speaker Amplifier

The MAX97000 Class D speaker amplifier utilizes active emissions limiting and spread-spectrum modulation to minimize the EMI radiated by the amplifier.

Audio Subsystem with Mono Class D Speaker and Class H Headphone Amplifier

Ultra-Low EMI Filterless Output Stage

Traditional Class D amplifiers require the use of external LC filters or shielding to meet EN55022B electromagnetic-interference (EMI) regulation standards. Maxim's active emissions limiting edge-rate control circuitry and spread-spectrum modulation reduces EMI emissions, while maintaining up to 87% efficiency. Maxim's spread-spectrum modulation mode flattens wideband spectral

components, while proprietary techniques ensure that the cycle-to-cycle variation of the switching period does not degrade audio reproduction or efficiency. The MAX97000's spread-spectrum modulator randomly varies the switching frequency by $\pm 20\text{kHz}$ around the center frequency (250kHz). Above 10MHz, the wideband spectrum looks like noise for EMI purposes (see Figure 4).

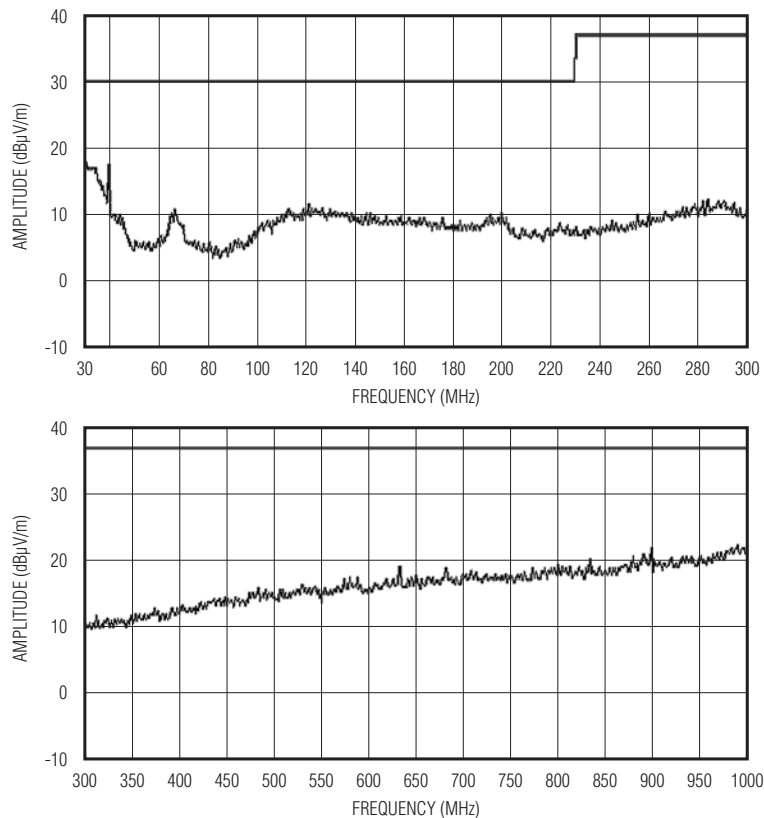

Figure 4. EMI with 15cm of Speaker Cable

Audio Subsystem with Mono Class D Speaker and Class H Headphone Amplifier

Distortion Limiter

The MAX97000 speaker amplifiers integrate a limiter to provide speaker protection and audio compression. When enabled, the limiter monitors the audio signal at the output of the Class D speaker amplifier and decreases the gain if the distortion exceeds the predefined threshold. The limiter automatically tracks the battery voltage to reduce the gain as the battery voltage drops.

Figure 5 shows the typical output vs. input curves with and without the distortion limiter. The dotted line shows the maximum gain for a given distortion limit without the distortion limiter. The solid line shows how, with the distortion limiter enabled, the gain can be increased without exceeding the set distortion limit. When the limiter is enabled, selecting a high gain level results in peak signals being attenuated while low signals are left unchanged. This increases the perceived loudness without the harshness of a clipped waveform.

Analog Switch

The MAX97000 integrates a DPST analog audio switch. This switch can be used to disconnect an independent audio signal, or drive the 8Ω speaker by connecting NC1 and NC2 to OUTN and OUTP, respectively. Unlike discrete solutions, the switch design reduces coupling of Class D switching noise to the COM_ inputs. This eliminates the need for a costly T-switch. Drive COM1 and COM2 with a low-impedance source to minimize noise on the pins. In applications that do not require the analog switch, leave COM1, COM2, NC1, and NC2 unconnected.

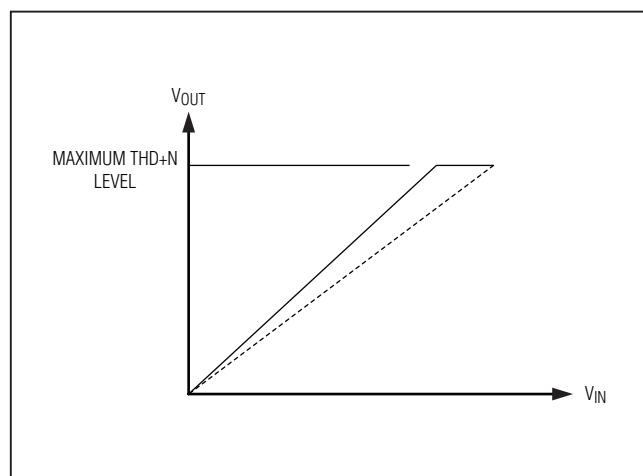

Figure 5. Limiter Gain Curve

Headphone Amplifier

DirectDrive

Traditional single-supply headphone amplifiers have outputs biased at a nominal DC voltage (typically half the supply). Large coupling capacitors are needed to block this DC bias from the headphone. Without these capacitors, a significant amount of DC current flows to the headphone, resulting in unnecessary power dissipation and possible damage to both headphone and headphone amplifier.

Maxim's DirectDrive® architecture uses a charge pump to create an internal negative supply voltage. This allows the headphone outputs of the MAX97000 to be biased at GND while operating from a single supply (Figure 6). Without a DC component, there is no need for the large DC-blocking capacitors. Instead of two large ($220\mu\text{F}$, typ) capacitors, the MAX97000 charge pump requires three small ceramic capacitors,

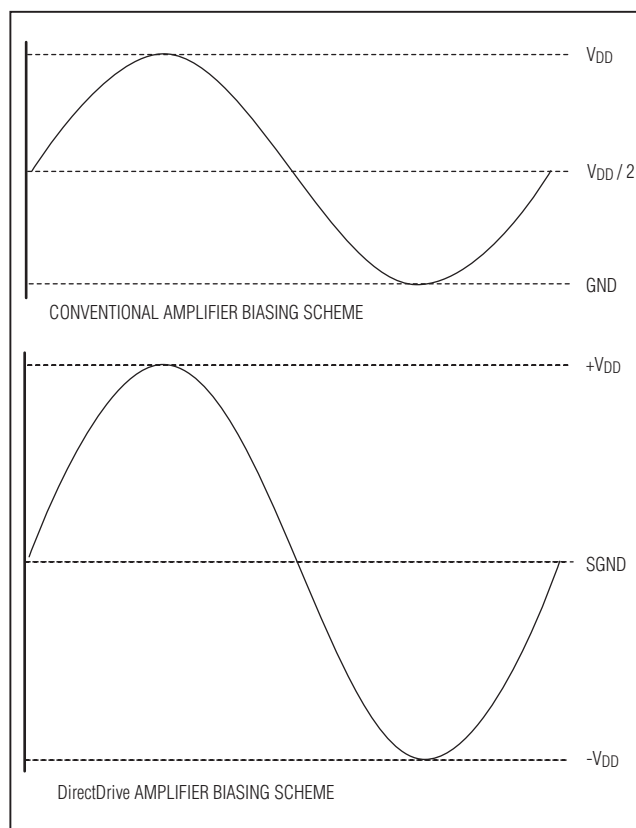

Figure 6. Traditional Amplifier Output vs. MAX97000 DirectDrive Output

DirectDrive is a registered trademark of Maxim Integrated Products, Inc.

Audio Subsystem with Mono Class D Speaker and Class H Headphone Amplifier

conserving board space, reducing cost, and improving the frequency response of the headphone amplifier. See the Output Power vs. Load Resistance graph in the *Typical Operating Characteristics* for details of the possible capacitor sizes. There is a low DC voltage on the amplifier outputs due to amplifier offset. However, the offset of the MAX97000 is typically $\pm 0.15\text{mV}$, which, when combined with a 32Ω load, results in less than $5\mu\text{A}$ of DC current flow to the headphones.

In addition to the cost and size disadvantages of the DC-blocking capacitors required by conventional headphone amplifiers, these capacitors limit the amplifier's low-frequency response and can distort the audio signal. Previous attempts at eliminating the output-coupling capacitors involved biasing the headphone return (sleeve) to the DC bias voltage of the headphone amplifiers. This method raises some issues:

- The sleeve is typically grounded to the chassis. Using the midrail biasing approach, the sleeve must be isolated from system ground, complicating product design.
- During an ESD strike, the amplifier's ESD structures are the only path to system ground. Thus, the amplifier must be able to withstand the full energy from an ESD strike.
- When using the headphone jack as a line out to other equipment, the bias voltage on the sleeve may conflict with the ground potential from other equipment, resulting in possible damage to the amplifiers.

Charge Pump

The MAX97000's dual-mode charge pump generates both the positive and negative power supply for the headphone amplifier. To maximize efficiency, both the charge pump's switching frequency and output voltage change based on signal level.

When the input signal level is less than 10% of VDD, the switching frequency is reduced to a low rate. This minimizes switching losses in the charge pump. When the input signal exceeds 10% of VDD, the switching frequency increases to support the load current.

For input signals below 25% of VDD, the charge pump generates $\pm(VDD/2)$ to minimize the voltage drop across the amplifier's power stage and thus improve efficiency. Input signals that exceed 25% of VDD cause the charge pump to output $\pm VDD$. The higher output voltage allows for full output power from the headphone amplifier.

To prevent audible glitches when transitioning from the $\pm(VDD/2)$ output mode to the $\pm VDD$ output mode, the charge pump transitions very quickly. This quick change draws significant current from VDD for the duration of the transition. The bypass capacitor on VDD supplies the required current and prevents droop on VDD.

The charge pump's dynamic switching mode can be turned off through the I²C interface. The charge pump can then be forced to output either $\pm(VDD/2)$ or $\pm VDD$ regardless of input signal level.

Class H Operation

A Class H amplifier uses a Class AB output stage with power supplies that are modulated by the output signal. In the case of the MAX97000, two nominal power-supply differentials of 1.8V (+0.9V to -0.9V) and 3.6V (+1.8V to -1.8V) are available from the charge pump. Figure 7 shows the operation of the output-voltage-dependent power supply.

Low-Power Mode

To minimize power consumption when using the headphone amplifier, enable the low-power mode. In this mode, the headphone mixers and volume control are bypassed and shut down.

I²C Slave Address

The MAX97000 uses a slave address of 0x9A or 1001101R \bar{W} . The address is defined as the 7 most significant bits (MSBs) followed by the read/write bit. Set the read/write bit to 1 to configure the MAX97000 to read mode. Set the read/write bit to 0 to configure the MAX97000 to write mode. The address is the first byte of information sent to the MAX97000 after the START (S) condition.

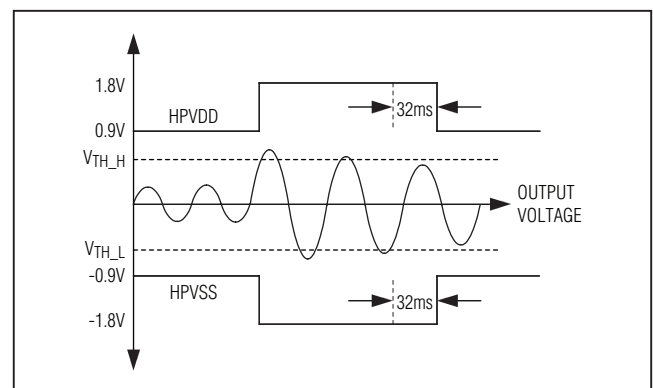

Figure 7. Class H Operation

Audio Subsystem with Mono Class D Speaker and Class H Headphone Amplifier

I²C Registers

Nine internal registers program the MAX97000. Table 1 lists all the registers, their addresses, and power-on-reset states. Register 0xFF indicates the device revision.

Write zeros to all unused bits in the register table when updating the register, unless otherwise noted. Tables 2 through 7 describe each bit.

Table 1. Register Map

REGISTER	B7	B6	B5	B4	B3	B2	B1	B0	ADDRESS	DEFAULT	R/W
STATUS											
Input Gain	INADIFF	INBDIFF	PGAINA		PGAINB				0x00	0x00	R/W
Headphone Mixers	HPLMIX				HPRMIX				0x01	0x00	R/W
Speaker Mixer	0	0	0	0	SPKMIX				0x02	0x00	R/W
Headphone Left	$\overline{\text{ZCD}}$	$\overline{\text{SLEW}}$	HPLM	HPLVOL					0x03	0x00	R/W
Headphone Right	LPGAIN	0	HPRM	HPRVOL					0x04	0x00	R/W
Speaker	FFM	SPKM	SPKVOL						0x05	0x00	R/W
Reserved	0	0	0	0	0	0	0	0	0x06	0x00	R/W
Limiter	THDCLP				0	0	0	THDT1	0x07	0x00	R/W
Power Management	$\overline{\text{SHDN}}$	LPMODE		SPKEN	0	HPLEN	HPREN	SWEN	0x08	0x01	R/W
Charge Pump	0	0	0	0	0	0	CPSEL	FIXED	0x09	0x00	R/W
REVISION ID											
Rev ID	REV								0xFF	0x00	R

Table 2. Input Register

REGISTER	BIT	NAME	DESCRIPTION	
0x00	7	INADIFF	Input A Differential Mode. Configures the input A channel as either a mono differential signal (INA = INA2 - INA1) or as a stereo signal (INA1 = left, INA2 = right). 0 = Stereo single-ended 1 = Differential	
	6	INBDIFF	Input B Differential Mode. Configures the input B channel as either a mono differential signal (INB = INB2 - INB1) or as a stereo signal (INB1 = left, INB2 = right). 0 = Stereo single-ended 1 = Differential	
	5	PGAINA	Input A Preamp Gain. Set the input gain to maximize output signal level for a given input signal range to improve the SNR of the system. PGAINA = 111 switches to a trimmed 20kΩ feedback resistor for external gain setting.	
	4		VALUE	LEVEL (dB)
			000	-6
	001		-3	
	010	0		
	011	3		
	100	6		
	101	9		
	110	18		
	111	External		

Audio Subsystem with Mono Class D Speaker and Class H Headphone Amplifier

Table 2. Input Register (continued)

REGISTER	BIT	NAME	DESCRIPTION	
	2	PGAINB	Input B Preamp Gain. Set the input gain to maximize output signal level for a given input signal range to improve the SNR of the system. PGAINB = 111 switches to a trimmed 20kΩ feedback resistor for external gain setting.	
	1		VALUE	LEVEL (dB)
			000	-6
			001	-3
			010	0
			011	3
			100	6
			101	9
	0		110	18
111		External		

Mixers

Table 3. Mixer Registers

REGISTER	BIT	NAME	DESCRIPTION	
0x01	7	HPLMIX	Left Headphone Mixer. Selects which of the four inputs is routed to the left headphone output.	
	6		VALUE	INPUT
	5		0000	No input
			xxx1	INA1 (Disabled when INADIFF = 1)
			xx1x	INA2 (Select when INADIFF = 1)
			x1xx	INB1 (Disabled when INBDIFF = 1)
	4	1xxx	INB2 (Select when INBDIFF = 1)	
	3	HPRMIX	Right Headphone Mixer. Selects which of the four inputs is routed to the right headphone output.	
	2		VALUE	INPUT
	1		0000	No input
xxx1			INA1 (Disabled when INADIFF = 1)	
xx1x			INA2 (Select when INADIFF = 1)	
x1xx		INB1 (Disabled when INBDIFF = 1)		
0	1xxx	INB2 (Select when INBDIFF = 1)		
0x02	3	SPKMIX	Speaker Mixer. Selects which of the four inputs is routed to the speaker output.	
	2		VALUE	INPUT
	1		0000	No input
			xxx1	INA1 (Disabled when INADIFF = 1)
			xx1x	INA2 (Select when INADIFF = 1)
x1xx		INB1 (Disabled when INBDIFF = 1)		
0	1xxx	INB2 (Select when INBDIFF = 1)		

Audio Subsystem with Mono Class D Speaker and Class H Headphone Amplifier

Volume Control

MAX97000

Table 4. Volume Control Registers

REGISTER	BIT	NAME	DESCRIPTION			
0x03	7	$\overline{\text{ZCD}}$	Zero-Crossing Detection. Determines whether zero-crossing detection is used on all volume control changes to reduce clicks and pops. Disabling zero-crossing detection allows volume changes to occur immediately. 0 = Enabled 1 = Disabled			
	6	$\overline{\text{SLEW}}$	Volume Slewing. Determines whether volume slewing is used on all volume control changes to reduce clicks and pops. When enabled, volume changes cause the MAX97000 to ramp through intermediate volume settings whenever a change to the volume is made. If $\overline{\text{ZCD}} = 1$, slewing occurs at a rate of 0.2ms per step. If $\overline{\text{ZCD}} = 0$, slew time depends on the input signal. Write a 1 to this bit to disable slewing and implement volume changes immediately. This bit also activates soft-start at power-on and soft-stop and power-off. 0 = Enabled 1 = Disabled			
	5	HPLM	Left Headphone Mute 0 = Unmuted 1 = Muted			
	4	HPLVOL	Left Headphone Volume			
	3		VALUE	LEVEL (dB)	VALUE	LEVEL (dB)
			0x00	-64	0x10	-12
	2		0x01	-60	0x11	-10
			0x02	-56	0x12	-8
			0x03	-52	0x13	-6
			0x04	-48	0x14	-4
0x05		-44	0x15	-2		
1	0x06	-40	0x16	-1		
	0x07	-37	0x17	0		
	0x08	-34	0x18	1		
0	0x09	-31	0x19	2		
	0x0A	-28	0x1A	3		
	0x0B	-25	0x1B	4		
	0x0C	-22	0x1C	4.5		
	0x0D	-19	0x1D	5		
	0x0E	-16	0x1E	5.5		
	0x0F	-14	0x1F	6		

Audio Subsystem with Mono Class D Speaker and Class H Headphone Amplifier

Table 4. Volume Control Registers (continued)

REGISTER	BIT	NAME	DESCRIPTION					
0x04	7	LPGAIN	Low-Power Mode Gain. Controls the headphone amplifier gain when LPMODE ≠ 0. 0 = 0dB 1 = 3dB					
	5	HPRM	Right Headphone Mute 0 = Unmuted 1 = Muted					
	4	HPRVOL	Right Headphone Volume					
	3		VALUE	LEVEL (dB)	VALUE	LEVEL (dB)		
			0x00	-64	0x10	-12		
	2		0x01	-60	0x11	-10		
			0x02	-56	0x12	-8		
			0x03	-52	0x13	-6		
			0x04	-48	0x14	-4		
			0x05	-44	0x15	-2		
0x06			-40	0x16	-1			
0x07			-37	0x17	0			
0x08		-34	0x18	1				
1	0x09	-31	0x19	2				
	0x0A	-28	0x1A	3				
0	0x0B	-25	0x1B	4				
	0x0C	-22	0x1C	4.5				
	0x0D	-19	0x1D	5				
	0x0E	-16	0x1E	5.5				
	0x0F	-14	0x1F	6				
0x05	7	FFM	Fixed-Frequency Oscillation. Removes spread spectrum from the class D oscillator. 0 = Spread-spectrum mode 1 = Fixed-frequency mode					
	6	SPKM	Speaker Mute 0 = Unmuted 1 = Mute					
	5	SPKVOL	Speaker Volume					
	4		VALUE	LEVEL (dB)	VALUE	LEVEL (dB)	VALUE	LEVEL (dB)
			0x00–0x18	-30	0x26	3	0x34	14.5
	3		0x19	-26	0x27	4	0x35	15
			0x1A	-22	0x28	5	0x36	15.5
			0x1B	-18	0x29	6	0x37	16
			0x1C	-14	0x2A	7	0x38	16.5
			0x1D	-12	0x2B	8	0x39	17
0x1E			-10	0x2C	9	0x3A	17.5	
2	0x1F		-8	0x2D	10	0x3B	18	
	0x20	-6	0x2E	11	0x3C	18.5		
1	0x21	-4	0x2F	12	0x3D	19		
	0x22	-2	0x30	12.5	0x3E	19.5		
0	0x23	0	0x31	13	0x3F	20		
	0x24	1	0x32	13.5				
		0x25	2	0x33	14			

Audio Subsystem with Mono Class D Speaker and Class H Headphone Amplifier

Distortion Limiter

MAX97000

Table 5. Distortion Limiter Register

REGISTER	BIT	NAME	DESCRIPTION																		
0x07	7	THDCLP	Distortion Limit																		
	6		<table border="1"> <thead> <tr> <th>VALUE</th> <th>THD LIMIT (%)</th> </tr> </thead> <tbody> <tr> <td>0000</td> <td>Disabled</td> </tr> <tr> <td>0001–1001</td> <td>≤ 4</td> </tr> <tr> <td>1010</td> <td>≤ 5</td> </tr> <tr> <td>1011</td> <td>≤ 6</td> </tr> <tr> <td>1100</td> <td>≤ 8</td> </tr> <tr> <td>1101</td> <td>≤ 11</td> </tr> <tr> <td>1110</td> <td>≤ 12</td> </tr> <tr> <td>1111</td> <td>≤ 15</td> </tr> </tbody> </table>	VALUE	THD LIMIT (%)	0000	Disabled	0001–1001	≤ 4	1010	≤ 5	1011	≤ 6	1100	≤ 8	1101	≤ 11	1110	≤ 12	1111	≤ 15
	VALUE		THD LIMIT (%)																		
	0000		Disabled																		
	0001–1001		≤ 4																		
1010	≤ 5																				
1011	≤ 6																				
1100	≤ 8																				
1101	≤ 11																				
1110	≤ 12																				
1111	≤ 15																				
5																					
4																					
0	THDT1	Distortion Release Time Constant 0 = 1.4s 1 = 2.8s																			

Power Management

Table 6. Power Management Register

REGISTER	BIT	NAME	DESCRIPTION										
0x08	7	$\overline{\text{SHDN}}$	Software Shutdown 0 = Device disabled 1 = Device enabled										
	6	LPMODE	Low-Power Headphone Mode. Enables low-power headphone mode. When activated this mode directly connects the selected channel to the headphone amplifiers, bypassing the mixers and the volume control. Additionally, low-power mode disables the speaker path.										
	5		<table border="1"> <thead> <tr> <th>VALUE</th> <th>INPUT</th> </tr> </thead> <tbody> <tr> <td>00</td> <td>Disabled</td> </tr> <tr> <td>01</td> <td>INA (SE) Connected to the headphone output</td> </tr> <tr> <td>10</td> <td>INB (SE) Connected to the headphone output</td> </tr> <tr> <td>11</td> <td>INA (Diff) to HPL and INB (Diff) to HPR</td> </tr> </tbody> </table>	VALUE	INPUT	00	Disabled	01	INA (SE) Connected to the headphone output	10	INB (SE) Connected to the headphone output	11	INA (Diff) to HPL and INB (Diff) to HPR
	VALUE		INPUT										
	00	Disabled											
	01	INA (SE) Connected to the headphone output											
	10	INB (SE) Connected to the headphone output											
11	INA (Diff) to HPL and INB (Diff) to HPR												
4	SPKEN	Speaker Amplifier Enable 0 = Disabled 1 = Enabled											
2	HPLEN	Left Headphone Amplifier Enable 0 = Disabled 1 = Enabled											
1	HPREN	Right Headphone Amplifier Enable 0 = Disabled 1 = Enabled											
0	SWEN	Analog Switch 0 = Open 1 = Closed											

Audio Subsystem with Mono Class D Speaker and Class H Headphone Amplifier

Charge-Pump Control

Table 7. Charge-Pump Control Register

REGISTER	BIT	NAME	DESCRIPTION
0x09	1	CPSEL	Charge-Pump Output Select. Works with the FIXED to set $\pm 1.8V$ or $\pm 0.9V$ outputs on HPVDD and HPVSS. Ignored when FIXED = 0. 0 = $\pm 1.8V$ on HPVDD/HPVSS 1 = $\pm 0.9V$ on HPVDD/HPVSS
	0	FIXED	Class H Mode. When enabled, this bit forces the charge pump to generate static power rails for HPVDD and HPVSS, instead of dynamically adjusting them based on output signal level. 0 = Class H mode 1 = Fixed-supply mode

I²C Serial Interface

The MAX97000 features an I²C/SMBus™-compatible, 2-wire serial interface consisting of a serial-data line (SDA) and a serial-clock line (SCL). SDA and SCL facilitate communication between the MAX97000 and the master at clock rates up to 400kHz. Figure 1 shows the 2-wire interface timing diagram. The master generates SCL and initiates data transfer on the bus. The master device writes data to the MAX97000 by transmitting the proper slave address followed by the register address and then the data word. Each transmit sequence is framed by a START (S) or REPEATED START (Sr) condition and a STOP (P) condition. Each word transmitted to the MAX97000 is 8 bits long and is followed by an acknowledge clock pulse. A master reading data from the MAX97000 transmits the proper slave address followed by a series of nine SCL pulses. The MAX97000 transmits data on SDA in sync with the master-generated SCL pulses. The master acknowledges receipt of each byte of data. Each read sequence is framed by a START or REPEATED START condition, a not acknowledge, and a STOP condition. SDA operates as both an input and an open-drain output. A pullup resistor, typically greater than 500 Ω , is required on SDA. SCL operates only as an input. A pullup resistor, typically greater than 500 Ω , is required on SCL if there are multiple masters on the bus, or if the single master has an open-drain SCL output. Series resistors in line with SDA and SCL are optional. Series resistors protect the digital inputs of the MAX97000 from high-voltage spikes on the bus lines, and minimize crosstalk and undershoot of the bus signals.

Bit Transfer

One data bit is transferred during each SCL cycle. The data on SDA must remain stable during the high period of the SCL pulse. Changes in SDA while SCL is high are control signals (see the *START and STOP Conditions* section).

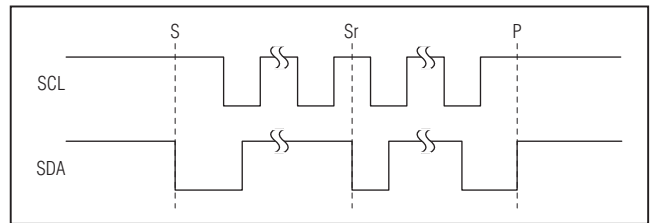

Figure 8. START, STOP, and REPEATED START Conditions

START and STOP Conditions

SDA and SCL idle high when the bus is not in use. A master initiates communication by issuing a START condition. A START condition is a high-to-low transition on SDA with SCL high. A STOP condition is a low-to-high transition on SDA while SCL is high (Figure 8). A START condition from the master signals the beginning of a transmission to the MAX97000. The master terminates transmission and frees the bus by issuing a STOP condition. The bus remains active if a REPEATED START condition is generated instead of a STOP condition.

Early STOP Conditions

The MAX97000 recognizes a STOP condition at any point during data transmission except if the STOP condition occurs in the same high pulse as a START condition. For proper operation, do not send a STOP condition during the same SCL high pulse as the START condition.

Slave Address

The slave address is defined as the seven most significant bits (MSBs) followed by the read/write bit. For the MAX97000 the seven most significant bits are 1001101. Setting the read/write bit to 1 (slave address = 0x9B) configures the MAX97000 for read mode. Setting the read/write bit to 0 (slave address = 0x9A) configures the MAX97000 for write mode. The address is the first byte of information sent to the MAX97000 after the START condition.

SMBus is a trademark of Intel Corp.

Audio Subsystem with Mono Class D Speaker and Class H Headphone Amplifier

Acknowledge

The acknowledge bit (ACK) is a clocked 9th bit that the MAX97000 uses to handshake receipt each byte of data when in write mode (Figure 9). The MAX97000 pulls down SDA during the entire master-generated 9th clock pulse if the previous byte is successfully received. Monitoring ACK allows for detection of unsuccessful data transfers. An unsuccessful data transfer occurs if a receiving device is busy or if a system fault has occurred. In the event of an unsuccessful data transfer, the bus master will retry communication. The master pulls down SDA during the 9th clock cycle to acknowledge receipt of data when the MAX97000 is in read mode. An

acknowledge is sent by the master after each read byte to allow data transfer to continue. A not-acknowledge is sent when the master reads the final byte of data from the MAX97000, followed by a STOP condition.

Write Data Format

A write to the MAX97000 includes transmission of a START condition, the slave address with the R/W bit set to 0, 1 byte of data to configure the internal register address pointer, 1 or more bytes of data, and a STOP condition. Figure 10 illustrates the proper frame format for writing 1 byte of data to the MAX97000. Figure 11 illustrates the frame format for writing n-bytes of data to the MAX97000.

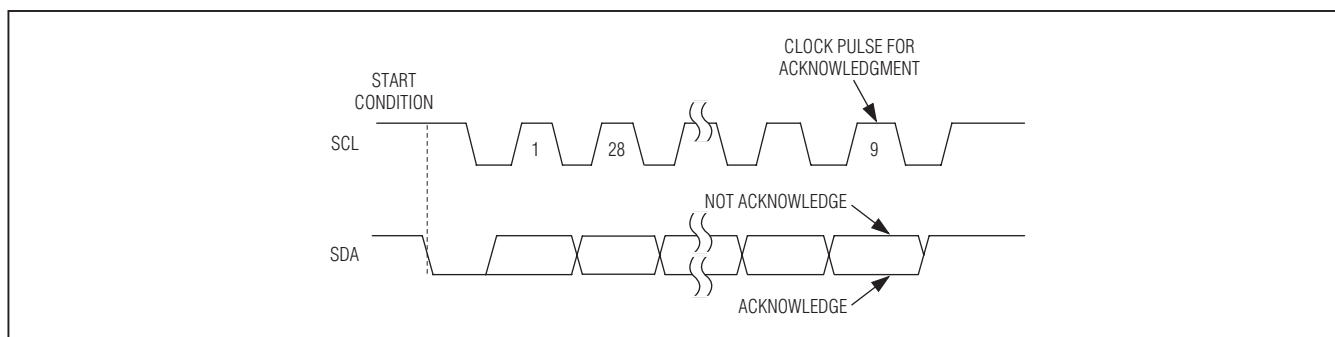

Figure 9. Acknowledge

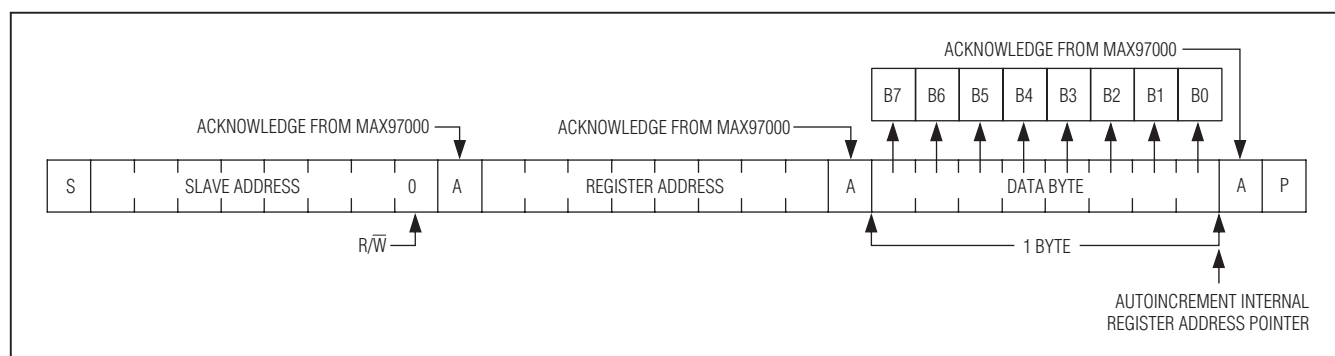

Figure 10. Writing 1 Byte of Data to the MAX97000

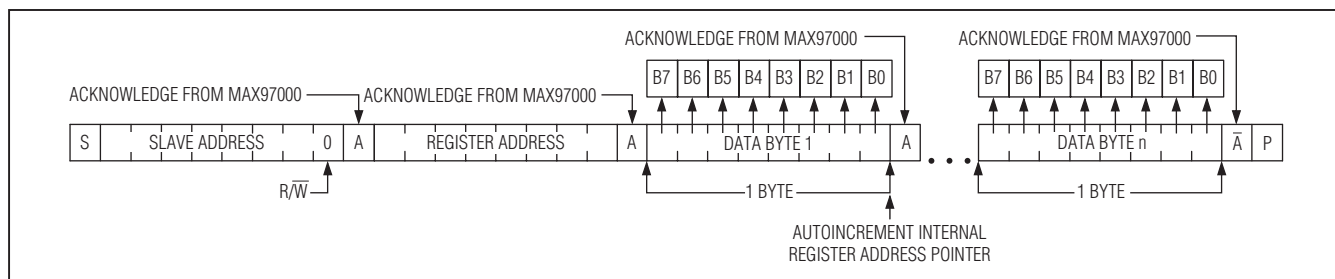

Figure 11. Writing n-Bytes of Data to the MAX97000

Audio Subsystem with Mono Class D Speaker and Class H Headphone Amplifier

The slave address with the R/\bar{W} bit set to 0 indicates that the master intends to write data to the MAX97000. The MAX97000 acknowledges receipt of the address byte during the master-generated 9th SCL pulse.

The second byte transmitted from the master configures the MAX97000's internal register address pointer. The pointer tells the MAX97000 where to write the next byte of data. An acknowledge pulse is sent by the MAX97000 upon receipt of the address pointer data.

The third byte sent to the MAX97000 contains the data that is written to the chosen register. An acknowledge pulse from the MAX97000 signals receipt of the data byte. The address pointer autoincrements to the next register address after each received data byte. This autoincrement feature allows a master to write to sequential registers within one continuous frame. The master signals the end of transmission by issuing a STOP condition. Register addresses greater than 0x09 are reserved. Do not write to these addresses.

Read Data Format

Send the slave address with the R/\bar{W} bit set to 1 to initiate a read operation. The MAX97000 acknowledges receipt of its slave address by pulling SDA low during the 9th SCL clock pulse. A START command followed by a read command resets the address pointer to register 0x00.

The first byte transmitted from the MAX97000 are the contents of register 0x00. Transmitted data is valid on the rising edge of SCL. The address pointer autoincrements after each read data byte. This autoincrement feature allows all registers to be read sequentially within one continuous frame. A STOP condition can be issued after any number of read data bytes. If a STOP condition is issued followed by another read operation, the first data byte to be read is from register 0x00.

The address pointer can be preset to a specific register before a read command is issued. The master presets the address pointer by first sending the MAX97000's slave address with the R/\bar{W} bit set to 0 followed by the register address. A REPEATED START condition is then sent followed by the slave address with the R/\bar{W} bit set to 1. The MAX97000 then transmits the contents of the specified register. The address pointer autoincrements after transmitting the first byte.

The master acknowledges receipt of each read byte during the acknowledge clock pulse. The master must acknowledge all correctly received bytes except the last byte. The final byte must be followed by a not acknowledge from the master and then a STOP condition. Figure 12 illustrates the frame format for reading 1 byte from the MAX97000. Figure 13 illustrates the frame format for reading multiple bytes from the MAX97000.

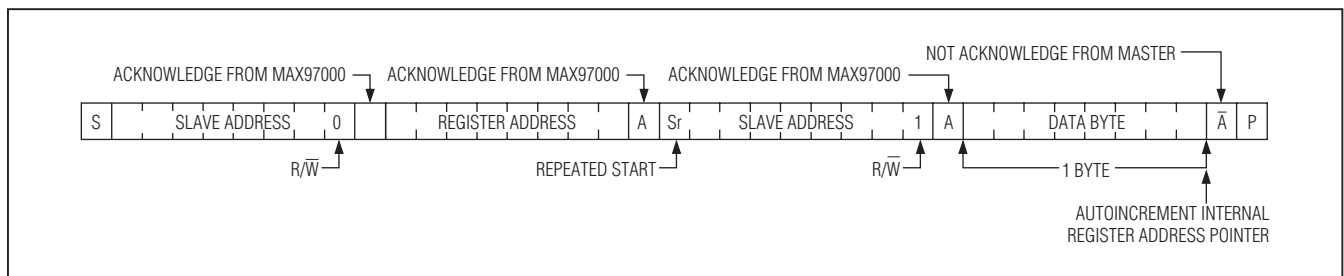

Figure 12. Reading 1 Byte of Data from the MAX97000

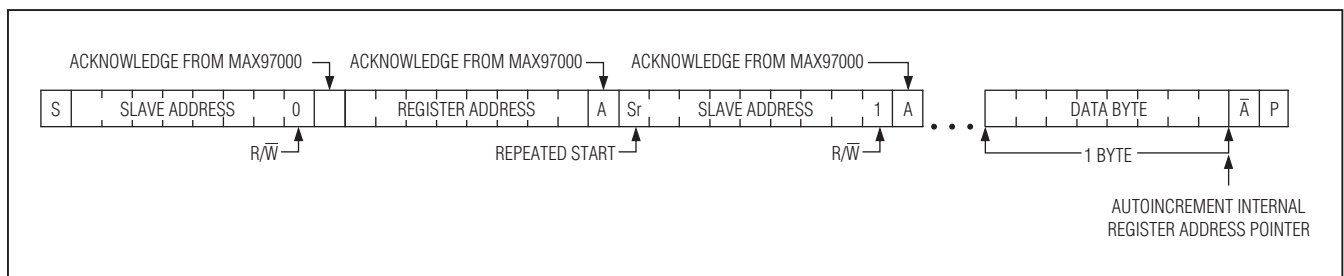

Figure 13. Reading n-Bytes of Data from the MAX97000

Audio Subsystem with Mono Class D Speaker and Class H Headphone Amplifier

Applications Information

Filterless Class D Operation

Traditional Class D amplifiers require an output filter to recover the audio signal from the amplifier's output. The filters add cost, increase the solution size of the amplifier, and can decrease efficiency and THD+N performance. The traditional PWM scheme uses large differential output swings ($2 \times V_{DD}$ peak-to-peak) and causes large ripple currents. Any parasitic resistance in the filter components results in a loss of power, lowering the efficiency.

The MAX97000 does not require an output filter. The device relies on the inherent inductance of the speaker coil and the natural filtering of both the speaker and the human ear to recover the audio component of the square-wave output. Eliminating the output filter results in a smaller, less costly, more efficient solution.

Because the frequency of the MAX97000 output is well beyond the bandwidth of most speakers, voice coil movement due to the square-wave frequency is very small. Although this movement is small, a speaker not designed to handle the additional power can be damaged. For optimum results, use a speaker with a series inductance $> 10\mu\text{H}$. Typical 8Ω speakers exhibit series inductances in the $20\mu\text{H}$ to $100\mu\text{H}$ range.

RF Susceptibility

GSM radios transmit using time-division multiple access (TDMA) with 217Hz intervals. The result is an RF signal with strong amplitude modulation at 217Hz and its harmonics that is easily demodulated by audio amplifiers. The MAX97000 is designed specifically to reject RF signals; however, PCB layout has a large impact on the susceptibility of the end product.

In RF applications, improvements to both layout and component selection decrease the MAX97000's susceptibility to RF noise and prevent RF signals from being demodulated into audible noise. Trace lengths should be kept below $1/4$ of the wavelength of the RF frequency of interest. Minimizing the trace lengths prevents them from functioning as antennas and coupling RF signals into the MAX97000. The wavelength (λ) in meters is given by: $\lambda = c/f$ where $c = 3 \times 10^8$ m/s, and f = the RF frequency of interest.

Route audio signals on middle layers of the PCB to allow ground planes above and below shield them from RF interference. Ideally the top and bottom layers of the PCB should primarily be ground planes to create effective shielding.

Additional RF immunity can also be obtained from relying on the self-resonant frequency of capacitors as it exhibits the frequency response similar to a notch filter. Depending on the manufacturer, 10pF to 20pF capacitors typically exhibit self-resonance at RF frequencies. These capacitors when placed at the input pins can effectively shunt the RF noise at the inputs of the MAX97000. For these capacitors to be effective, they must have a low-impedance, low-inductance path to the ground plane. Do not use microvias to connect to the ground plane as these vias do not conduct well at RF frequencies.

Component Selection

Optional Ferrite Bead Filter

Additional EMI suppression can be achieved using a filter constructed from a ferrite bead and a capacitor to ground (Figure 14). Use a ferrite bead with low DC resistance, high-frequency ($> 600\text{MHz}$) impedance between 100Ω and 600Ω , and rated for at least 1A. The capacitor value varies based on the ferrite bead chosen and the actual speaker lead length. Select a capacitor less than 1nF based on EMI performance.

Input Capacitor

An input capacitor, C_{IN} , in conjunction with the input impedance of the MAX97000 line inputs forms a high-pass filter that removes the DC bias from an incoming analog signal. The AC-coupling capacitor allows the amplifier to automatically bias the signal to an optimum DC level. Assuming zero-source impedance, the -3dB point of the highpass filter is given by:

$$f_{-3dB} = \frac{1}{2\pi R_{IN} C_{IN}}$$

Choose C_{IN} such that f_{-3dB} is well below the lowest frequency of interest. For best audio quality, use capacitors whose dielectrics have low-voltage coefficients, such as tantalum or aluminum electrolytic. Capacitors with high-voltage coefficients, such as ceramics, may result in increased distortion at low frequencies.

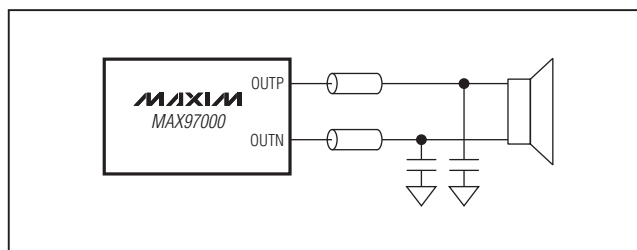

Figure 14. Optional Class D Ferrite Bead Filter

Audio Subsystem with Mono Class D Speaker and Class H Headphone Amplifier

Charge-Pump Capacitor Selection

Use capacitors with an ESR less than 100mΩ for optimum performance. Low-ESR ceramic capacitors minimize the output resistance of the charge pump. Most surface-mount ceramic capacitors satisfy the ESR requirement. For best performance over the extended temperature range, select capacitors with an X7R dielectric.

Charge-Pump Flying Capacitor

The value of the flying capacitor (connected between C1N and C1P) affects the output resistance of the charge pump. A value that is too small degrades the device's ability to provide sufficient current drive, which leads to a loss of output voltage. Increasing the value of the flying capacitor reduces the charge-pump output resistance to an extent. Above 1μF, the on-resistance of the internal switches and the ESR of external charge-pump capacitors dominate.

Charge-Pump Holding Capacitor

The holding capacitor (bypassing HPVDD and HPVSS) value and ESR directly affect the ripple on the supply. Increasing the capacitor's value reduces output ripple. Likewise, decreasing the ESR reduces both ripple and output resistance. Lower capacitance values can be used in systems with low maximum output power levels. See the Output Power vs. Load Resistance graph in the *Typical Operating Characteristics* section for more information.

Supply Bypassing, Layout, and Grounding

Proper layout and grounding are essential for optimum performance. Use a large continuous ground plane on a dedicated layer of the PCB to minimize loop areas. Connect GND and PGND directly to the ground plane using the shortest trace length possible. Proper grounding improves audio performance, minimizes crosstalk between channels, and prevents any digital noise from coupling into the analog audio signals.

Place the capacitor between C1P and C1N as close as possible to the MAX97000 to minimize trace length from C1P to C1N. Inductance and resistance added between C1P and C1N reduce the output power of the headphone amplifier. Bypass HPVDD and HPVSS with capacitors located close to the pins with a short trace length to PGND. Close decoupling of HPVDD and HPVSS minimizes supply ripple and maximizes output power from the headphone amplifier.

Bypass PVDD to PGND with as little trace length as possible. Connect OUTP and OUTN to the speaker using the shortest and widest traces possible. Reducing trace length minimizes radiated EMI. Route OUTP/OUTN as a differential pair on the PCB to minimize the loop area and thereby the inductance of the circuit. If filter components are used on the speaker outputs, be sure to locate them as close to the MAX97000 as possible to ensure maximum effectiveness. Minimize the trace length from any ground tied passive components to PGND to further minimize radiated EMI.

An evaluation kit (EV kit) is available to provide an example layout for the MAX97000. The EV kit allows quick setup of the MAX97000 and includes easy-to-use software allowing all internal registers to be controlled.

WLP Applications Information

For the latest application details on WLP construction, dimensions, tape carrier information, PCB techniques, bump-pad layout, and recommended reflow temperature profile, as well as the latest information on reliability testing results, refer to the *Application Note: UCSP - A Wafer-Level Chip-Scale Package* on Maxim's website at www.maxim-ic.com/ucsp. See Figure 15 for the recommended PCB footprint for the MAX97000.

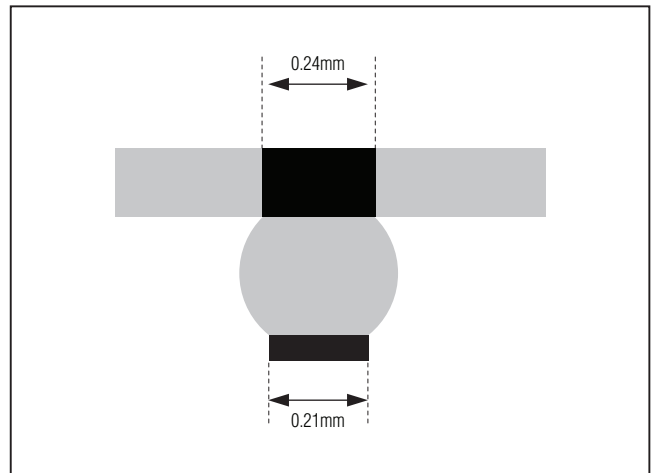

Figure 15. Recommended PCB Footprint

Audio Subsystem with Mono Class D Speaker and Class H Headphone Amplifier

MAX97000

Package Information

For the latest package outline information and land patterns, go to www.maxim-ic.com/packages. Note that a "+", "#", or "-" in the package code indicates RoHS status only. Package drawings may show a different suffix character, but the drawing pertains to the package regardless of RoHS status.

PACKAGE TYPE	PACKAGE CODE	DOCUMENT NO.
25 WLP	W252F2+1	21-0453

COMMON DIMENSIONS	
A	0.64±0.05
A1	0.19±0.03
A2	0.45 REF
A3	0.025 BASIC
b	∅0.27±0.03
D1	1.60
E1	1.60
e	0.40 BASIC
SD	0.00 BASIC
SE	0.00 BASIC

PKG. CODE	E		D		DEPOPULATED BUMPS
	MIN	MAX	MIN	MAX	
W252D2+1	2.25	2.36	2.25	2.36	NONE
W252F2+1	2.02	2.16	2.02	2.16	NONE
W252G2+1	2.32	2.44	2.22	2.34	NONE

NOTES:

- Terminal pitch is defined by terminal center to center value.
- Outer dimension is defined by center lines between scribe lines.
- All dimensions in millimeters.
- Marking shown is for package orientation reference only.
- Tolerance is ± 0.02mm unless specified otherwise.
- All dimensions apply to PbFree (+) package codes only.
- Front-side finish can be either Black or Clear.

—DRAWING NOT TO SCALE—

TITLE: PACKAGE OUTLINE, 25 BUMPS, WLP PKG. 0.4mm PITCH			
APPROVAL	DOCUMENT CONTROL NO. 21-0453	REV. C	1/1

Audio Subsystem with Mono Class D Speaker and Class H Headphone Amplifier

Revision History

REVISION NUMBER	REVISION DATE	DESCRIPTION	PAGES CHANGED
0	11/09	Initial release	—
1	6/10	Updated to show the device allows VDD to be externally supplied	1, 4, 5, 18

Maxim cannot assume responsibility for use of any circuitry other than circuitry entirely embodied in a Maxim product. No circuit patent licenses are implied. Maxim reserves the right to change the circuitry and specifications without notice at any time.

34 **Maxim Integrated Products, 120 San Gabriel Drive, Sunnyvale, CA 94086 408-737-7600**

© 2010 Maxim Integrated Products

Maxim is a registered trademark of Maxim Integrated Products, Inc.