

# MC10H130

## Dual Latch

### Description

The MC10H130 is a MECL 10H™ part which is a functional/pinout duplication of the standard MECL 10K™ family part, with 100% improvement in clock speed and propagation delay and no increase in power supply current.

### Features

- Propagation Delay, 1.0 ns Typical
- Power Dissipation, 155 mW Typical
- Improved Noise Margin 150 mV (Over Operating Voltage and Temperature Range)
- Voltage Compensated
- MECL 10K Compatible
- Pb-Free Packages are Available\*

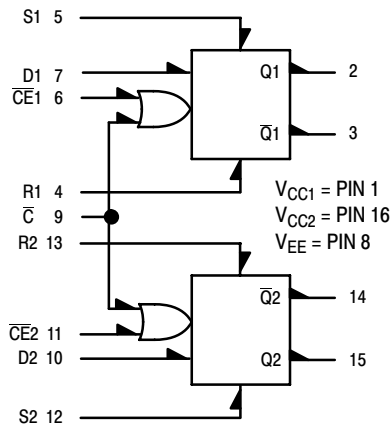
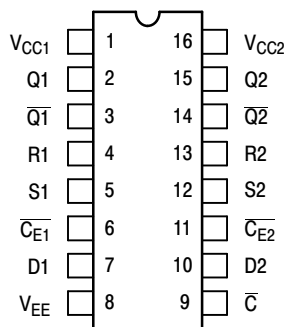

Figure 1. Logic Diagram



Pin assignment is for Dual-in-Line Package.

Figure 2. Pin Assignment

\*For additional information on our Pb-Free strategy and soldering details, please download the ON Semiconductor Soldering and Mounting Techniques Reference Manual, SOLDERRM/D.



ON Semiconductor®

<http://onsemi.com>

### MARKING DIAGRAMS\*

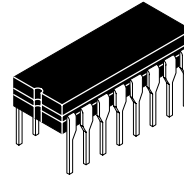

CDIP-16  
L SUFFIX  
CASE 620A

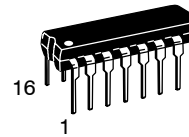
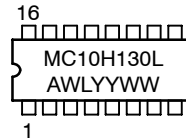

PDIP-16  
P SUFFIX  
CASE 648

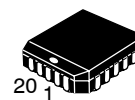
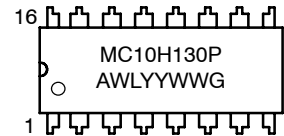

PLLC-20  
FN SUFFIX  
CASE 775

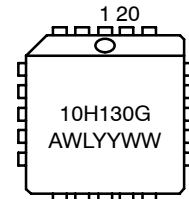

- A = Assembly Location
- WL = Wafer Lot
- YY = Year
- WW = Work Week
- G = Pb-Free Package

\*For additional marking information, refer to Application Note AND8002/D.

### ORDERING INFORMATION

See detailed ordering and shipping information in the package dimensions section on page 3 of this data sheet.

# MC10H130

**Table 1. MAXIMUM RATINGS**

| Symbol           | Characteristic                                  | Rating                     | Unit     |
|------------------|---|----------------------------|----------|
| V <sub>EE</sub>  | Power Supply (V <sub>CC</sub> = 0)              | -8.0 to 0                  | Vdc      |
| V <sub>I</sub>   | Input Voltage (V <sub>CC</sub> = 0)             | 0 to V <sub>EE</sub>       | Vdc      |
| I <sub>out</sub> | Output Current<br>Continuous<br>Surge           | 50<br>100                  | mA       |
| T <sub>A</sub>   | Operating Temperature Range                     | 0 to +75                   | °C       |
| T <sub>stg</sub> | Storage Temperature Range<br>Plastic<br>Ceramic | -55 to +150<br>-55 to +165 | °C<br>°C |

Maximum ratings are those values beyond which device damage can occur. Maximum ratings applied to the device are individual stress limit values (not normal operating conditions) and are not valid simultaneously. If these limits are exceeded, device functional operation is not implied, damage may occur and reliability may be affected.

**Table 2. ELECTRICAL CHARACTERISTICS** (V<sub>EE</sub> = -5.2 V ±5%) (Note 1)

| Symbol           | Characteristic       | 0°    |       | 25°   |       | 75°   |        | Unit |
|------------------|----------------------|-------|-------|-------|-------|-------|--------|------|
|                  |                      | Min   | Max   | Min   | Max   | Min   | Max    |      |
| I <sub>E</sub>   | Power Supply Current | -     | 38    | -     | 35    | -     | 38     | mA   |
| I <sub>inH</sub> | Input Current High   |       |       |       |       |       |        | μA   |
|                  | Pins 6, 11           | -     | 468   | -     | 275   | -     | 275    |      |
|                  | Pins 7, 9, 10        | -     | 545   | -     | 320   | -     | 320    |      |
|                  | Pins 4, 5, 12, 13    | -     | 434   | -     | 255   | -     | 255    |      |
| I <sub>inL</sub> | Input Current Low    | 0.5   | -     | 0.5   | -     | 0.3   | -      | μA   |
| V <sub>OH</sub>  | High Output Voltage  | -1.02 | -0.84 | -0.98 | -0.81 | -0.92 | -0.735 | Vdc  |
| V <sub>OL</sub>  | Low Output Voltage   | -1.95 | -1.63 | -1.95 | -1.63 | -1.95 | -1.60  | Vdc  |
| V <sub>IH</sub>  | High Input Voltage   | -1.17 | -0.84 | -1.13 | -0.81 | -1.07 | -0.735 | Vdc  |
| V <sub>IL</sub>  | Low Input Voltage    | -1.95 | -1.48 | -1.95 | -1.48 | -1.95 | -1.45  | Vdc  |

1. Each MECL 10H™ series circuit has been designed to meet the dc specifications shown in the test table, after thermal equilibrium has been established. The circuit is in a test socket or mounted on a printed circuit board and transverse air flow greater than 500 linear fpm is maintained. Outputs are terminated through a 50 Ω resistor to -2.0 V.

**Table 3. AC PARAMETERS**

| Symbol            | Characteristic         | 0°  |     | 25° |     | 75° |     | Unit |
|-------------------|------------------------|-----|-----|-----|-----|-----|-----|------|
|                   |                        | Min | Max | Min | Max | Min | Max |      |
| t <sub>pd</sub>   | Propagation Delay      |     |     |     |     |     |     | ns   |
|                   | Data                   | 0.4 | 1.6 | 0.4 | 1.7 | 0.4 | 1.8 |      |
|                   | Set, Reset             | 0.6 | 1.7 | 0.7 | 1.8 | 0.8 | 1.9 |      |
|                   | Clock, $\overline{CE}$ | 0.5 | 1.6 | 0.5 | 1.7 | 0.6 | 1.8 |      |
| t <sub>r</sub>    | Rise Time              | 0.5 | 1.6 | 0.5 | 1.7 | 0.5 | 1.8 | ns   |
| t <sub>f</sub>    | Fall Time              | 0.5 | 1.6 | 0.5 | 1.7 | 0.5 | 1.8 | ns   |
| t <sub>set</sub>  | Set-up Time            | 2.2 | -   | 2.2 | -   | 2.2 | -   | ns   |
| t <sub>hold</sub> | Hold Time              | 0.7 | -   | 0.7 | -   | 0.7 | -   | ns   |

NOTE: Device will meet the specifications after thermal equilibrium has been established when mounted in a test socket or printed circuit board with maintained transverse airflow greater than 500 lfpm. Electrical parameters are guaranteed only over the declared operating temperature range. Functional operation of the device exceeding these conditions is not implied. Device specification limit values are applied individually under normal operating conditions and not valid simultaneously.

# MC10H130

## APPLICATION INFORMATION

The MC10H130 is a clocked dual D type latch. Each latch may be clocked separately by holding the common clock in the low state, and using the clock enable inputs for the clocking function. If the common clock is to be used to clock the latch, the clock enable ( $\overline{CE}$ ) inputs must be in the low state. In this mode, the enable inputs perform the function of controlling the common clock ( $\overline{C}$ ).

Any change at the D input will be reflected at the output while the clock is low. The outputs are latched on the

positive transition of the clock. While the clock is in the high state, a change in the information present at the data inputs will not affect the output information.

The set and reset inputs do not override the clock and D inputs. They are effective only when either  $\overline{C}$  or  $\overline{CE}$  or both are high.

## ORDERING INFORMATION

| Device        | Package              | Shipping <sup>†</sup> |
|---------------|----------------------|-----------------------|
| MC10H130FN    | PLLC-20              | 46 Units / Rail       |
| MC10H130FNG   | PLLC-20<br>(Pb-Free) | 46 Units / Rail       |
| MC10H130FNR2  | PLLC-20              | 500 / Tape & Reel     |
| MC10H130FNR2G | PLLC-20<br>(Pb-Free) | 500 / Tape & Reel     |
| MC10H130L     | CDIP-16              | 25 Unit / Rail        |
| MC10H130P     | PDIP-16              | 25 Unit / Rail        |
| MC10H130PG    | PDIP-16<br>(Pb-Free) | 25 Unit / Rail        |

<sup>†</sup>For information on tape and reel specifications, including part orientation and tape sizes, please refer to our Tape and Reel Packaging Specifications Brochure, BRD8011/D.

# MC10H130

## PACKAGE DIMENSIONS

20 LEAD PLLC  
CASE 775-02  
ISSUE E

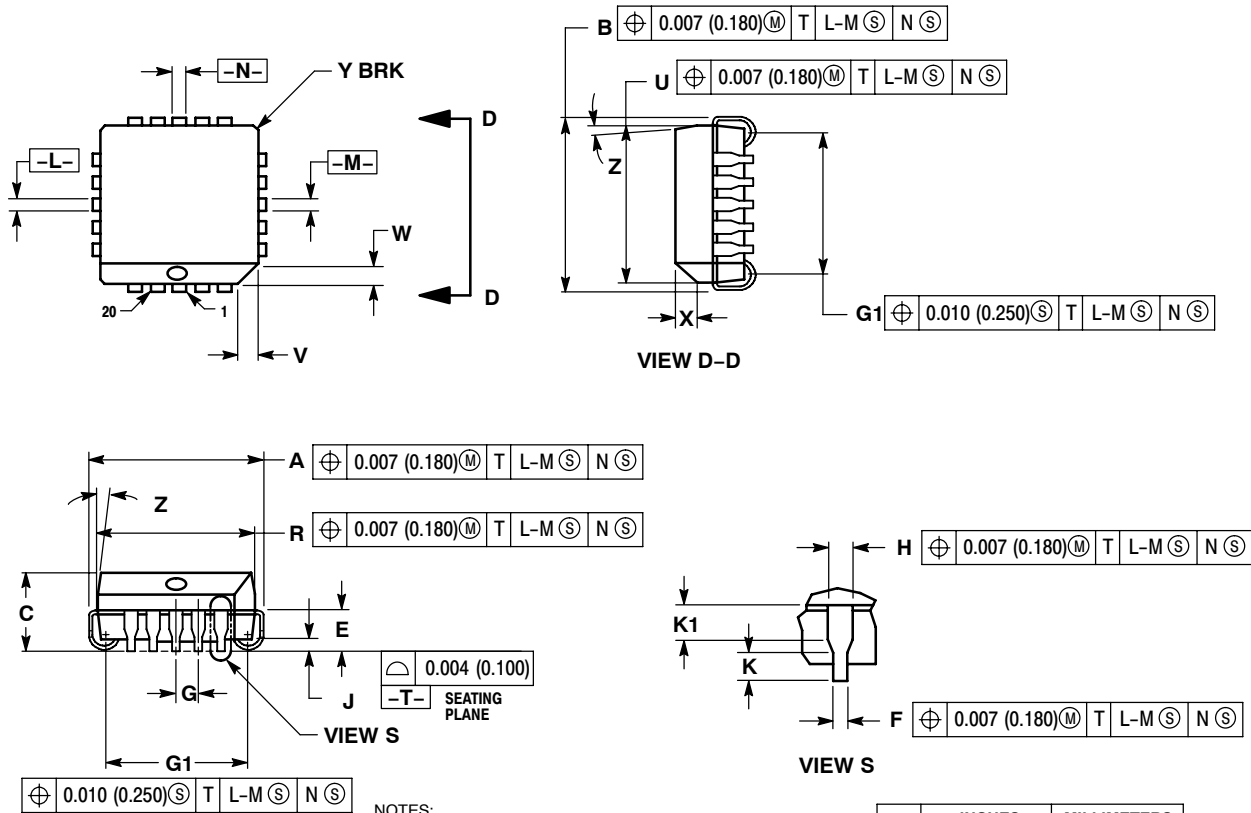

- NOTES:
1. DIMENSIONS AND TOLERANCING PER ANSI Y14.5M, 1982.
  2. DIMENSIONS IN INCHES.
  3. DATUMS -L-, -M-, AND -N- DETERMINED WHERE TOP OF LEAD SHOULDER EXITS PLASTIC BODY AT MOLD PARTING LINE.
  4. DIMENSION G1, TRUE POSITION TO BE MEASURED AT DATUM -T-, SEATING PLANE.
  5. DIMENSIONS R AND U DO NOT INCLUDE MOLD FLASH. ALLOWABLE MOLD FLASH IS 0.010 (0.250) PER SIDE.
  6. DIMENSIONS IN THE PACKAGE TOP MAY BE SMALLER THAN THE PACKAGE BOTTOM BY UP TO 0.012 (0.300). DIMENSIONS R AND U ARE DETERMINED AT THE OUTERMOST EXTREMES OF THE PLASTIC BODY EXCLUSIVE OF MOLD FLASH, TIE BAR BURRS, GATE BURRS AND INTERLEAD FLASH, BUT INCLUDING ANY MISMATCH BETWEEN THE TOP AND BOTTOM OF THE PLASTIC BODY.
  7. DIMENSION H DOES NOT INCLUDE DAMBAR PROTRUSION OR INTRUSION. THE DAMBAR PROTRUSION(S) SHALL NOT CAUSE THE H DIMENSION TO BE GREATER THAN 0.037 (0.940). THE DAMBAR INTRUSION(S) SHALL NOT CAUSE THE H DIMENSION TO BE SMALLER THAN 0.025 (0.635).

| DIM | INCHES    |       | MILLIMETERS |       |
|-----|-----------|-------|-------------|-------|
|     | MIN       | MAX   | MIN         | MAX   |
| A   | 0.385     | 0.395 | 9.78        | 10.03 |
| B   | 0.385     | 0.395 | 9.78        | 10.03 |
| C   | 0.165     | 0.180 | 4.20        | 4.57  |
| E   | 0.090     | 0.110 | 2.29        | 2.79  |
| F   | 0.013     | 0.019 | 0.33        | 0.48  |
| G   | 0.050 BSC |       | 1.27 BSC    |       |
| H   | 0.026     | 0.032 | 0.66        | 0.81  |
| J   | 0.020     | ---   | 0.51        | ---   |
| K   | 0.025     | ---   | 0.64        | ---   |
| R   | 0.350     | 0.356 | 8.89        | 9.04  |
| U   | 0.350     | 0.356 | 8.89        | 9.04  |
| V   | 0.042     | 0.048 | 1.07        | 1.21  |
| W   | 0.042     | 0.048 | 1.07        | 1.21  |
| X   | 0.042     | 0.056 | 1.07        | 1.42  |
| Y   | ---       | 0.020 | ---         | 0.50  |
| Z   | 2° 10°    |       | 2° 10°      |       |
| G1  | 0.310     | 0.330 | 7.88        | 8.38  |
| K1  | 0.040     | ---   | 1.02        | ---   |

# MC10H130

## PACKAGE DIMENSIONS

### CDIP-16 L SUFFIX CERAMIC DIP PACKAGE CASE 620A-01 ISSUE O

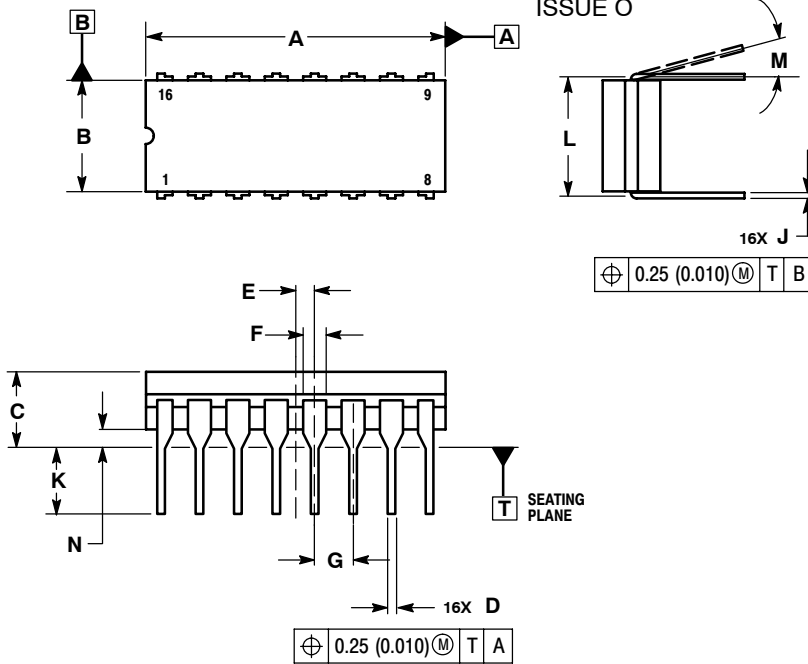

NOTES:

1. DIMENSIONING AND TOLERANCING PER ASME Y14.5M, 1994.
2. CONTROLLING DIMENSION: INCH.
3. DIMENSION L TO CENTER OF LEAD WHEN FORMED PARALLEL.
4. DIMENSION F MAY NARROW TO 0.76 (0.030) WHERE THE LEAD ENTERS THE CERAMIC BODY.
5. THIS DRAWING REPLACES OBSOLETE CASE OUTLINE 620-10.

| DIM | INCHES    |       | MILLIMETERS |       |
|-----|-----------|-------|-------------|-------|
|     | MIN       | MAX   | MIN         | MAX   |
| A   | 0.750     | 0.785 | 19.05       | 19.93 |
| B   | 0.240     | 0.295 | 6.10        | 7.49  |
| C   | ---       | 0.200 | ---         | 5.08  |
| D   | 0.015     | 0.020 | 0.39        | 0.50  |
| E   | 0.050 BSC |       | 1.27 BSC    |       |
| F   | 0.055     | 0.065 | 1.40        | 1.65  |
| G   | 0.100 BSC |       | 2.54 BSC    |       |
| H   | 0.008     | 0.015 | 0.21        | 0.38  |
| K   | 0.125     | 0.170 | 3.18        | 4.31  |
| L   | 0.300 BSC |       | 7.62 BSC    |       |
| M   | 0°        | 15°   | 0°          | 15°   |
| N   | 0.020     | 0.040 | 0.51        | 1.01  |

### PDIP-16 P SUFFIX PLASTIC DIP PACKAGE CASE 648-08 ISSUE R

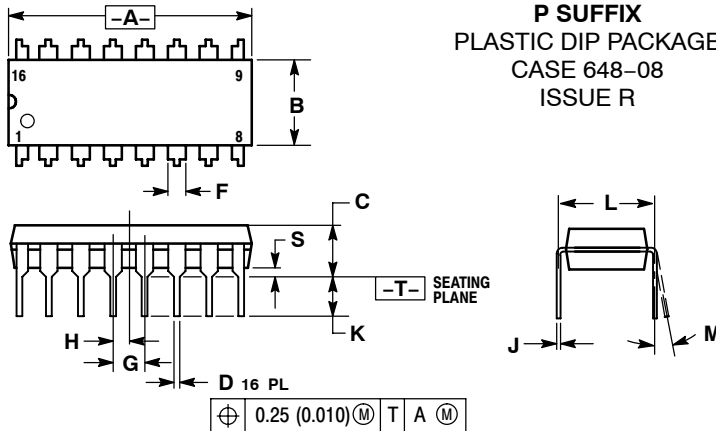

NOTES:

1. DIMENSIONING AND TOLERANCING PER ANSI Y14.5M, 1982.
2. CONTROLLING DIMENSION: INCH.
3. DIMENSION L TO CENTER OF LEADS WHEN FORMED PARALLEL.
4. DIMENSION B DOES NOT INCLUDE MOLD FLASH.
5. ROUNDED CORNERS OPTIONAL.

| DIM | INCHES    |       | MILLIMETERS |       |
|-----|-----------|-------|-------------|-------|
|     | MIN       | MAX   | MIN         | MAX   |
| A   | 0.740     | 0.770 | 18.80       | 19.55 |
| B   | 0.250     | 0.270 | 6.35        | 6.85  |
| C   | 0.145     | 0.175 | 3.69        | 4.44  |
| D   | 0.015     | 0.021 | 0.39        | 0.53  |
| F   | 0.040     | 0.70  | 1.02        | 1.77  |
| G   | 0.100 BSC |       | 2.54 BSC    |       |
| H   | 0.050 BSC |       | 1.27 BSC    |       |
| J   | 0.008     | 0.015 | 0.21        | 0.38  |
| K   | 0.110     | 0.130 | 2.80        | 3.30  |
| L   | 0.295     | 0.305 | 7.50        | 7.74  |
| M   | 0°        | 10°   | 0°          | 10°   |
| S   | 0.020     | 0.040 | 0.51        | 1.01  |

MECL 10H and MECL 10K are trademarks of Motorola, Inc.

**ON Semiconductor** and  $\textcircled{ON}$  are registered trademarks of Semiconductor Components Industries, LLC (SCILLC). SCILLC reserves the right to make changes without further notice to any products herein. SCILLC makes no warranty, representation or guarantee regarding the suitability of its products for any particular purpose, nor does SCILLC assume any liability arising out of the application or use of any product or circuit, and specifically disclaims any and all liability, including without limitation special, consequential or incidental damages. "Typical" parameters which may be provided in SCILLC data sheets and/or specifications can and do vary in different applications and actual performance may vary over time. All operating parameters, including "Typicals" must be validated for each customer application by customer's technical experts. SCILLC does not convey any license under its patent rights nor the rights of others. SCILLC products are not designed, intended, or authorized for use as components in systems intended for surgical implant into the body, or other applications intended to support or sustain life, or for any other application in which the failure of the SCILLC product could create a situation where personal injury or death may occur. Should Buyer purchase or use SCILLC products for any such unintended or unauthorized application, Buyer shall indemnify and hold SCILLC and its officers, employees, subsidiaries, affiliates, and distributors harmless against all claims, costs, damages, and expenses, and reasonable attorney fees arising out of, directly or indirectly, any claim of personal injury or death associated with such unintended or unauthorized use, even if such claim alleges that SCILLC was negligent regarding the design or manufacture of the part. SCILLC is an Equal Opportunity/Affirmative Action Employer. This literature is subject to all applicable copyright laws and is not for resale in any manner.

## PUBLICATION ORDERING INFORMATION

### LITERATURE FULFILLMENT:

Literature Distribution Center for ON Semiconductor  
P.O. Box 61312, Phoenix, Arizona 85082-1312 USA  
Phone: 480-829-7710 or 800-344-3860 Toll Free USA/Canada  
Fax: 480-829-7709 or 800-344-3867 Toll Free USA/Canada  
Email: orderlit@onsemi.com

**N. American Technical Support:** 800-282-9855 Toll Free USA/Canada

**Japan:** ON Semiconductor, Japan Customer Focus Center  
2-9-1 Kamimeguro, Meguro-ku, Tokyo, Japan 153-0051  
Phone: 81-3-5773-3850

**ON Semiconductor Website:** <http://onsemi.com>

**Order Literature:** <http://www.onsemi.com/litorder>

For additional information, please contact your local Sales Representative.

**MC10H130/D**