



TDA7567PD

4 x 50 W differential quad power amplifier with built-in diagnostics features

Features

- Multipower BCD technology
- MOSFET output power stage
- DMOS power output
- Differential Input
- New high efficiency (class SB)
- High output power capability 4x28 W/4 Ω @ 14.4 V, 1 kHz, 10% THD, 4x50 W MAX power
- Max. output power 4x72 W/2 Ω
- Full I²C bus driving:
 - Standby
 - Independent front/rear soft play/mute
 - Selectable gain 26 dB /16 dB (for low noise line output function)
 - High efficiency enable/disable
 - I²C bus digital diagnostics (including DC and AC load detection)
- Operates both in I²C and non-I²C bus mode
- Two selectable I²C bus addresses
- Full fault protection
- DC offset detection
- Four independent short circuit protection
- Clipping detector pin with selectable threshold (2%/10%)
- Standby/mute pin
- Linear thermal shutdown with multiple thermal warning
- ESD protection

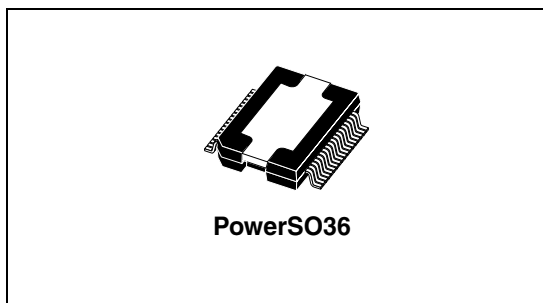

Description

The TDA7567PD is a new BCD technology quad bridge power amplifier in PowerSO36 package specially intended for automotive applications.

Thanks to the DMOS output stage the TDA7567PD has a very low distortion allowing a clear powerful sound. Among the features, its superior efficiency performance coming from the internal exclusive structure, makes it the most suitable device to simplify the thermal management in high power sets.

The dissipated output power under average listening condition is in fact reduced up to 50 % when compared to the level provided by conventional class AB solutions.

This device is equipped with a full diagnostics array that communicates the status of each speaker through the I²C bus.

The I²C bus can be disabled and the device can be controlled by standby/mute pin.

Table 1. Device summary

Order code	Package	Packing
TDA7567PD	PowerSO36	Tube
TDA7567PDTR	PowerSO36	Tape and reel

Contents

1	Block, application and pins connection diagrams	6
2	Electrical specifications	8
2.1	Absolute maximum ratings	8
2.2	Thermal data	8
2.3	Electrical characteristics	8
3	Diagnostics functional description	12
3.1	Turn-on diagnostic	12
3.2	Permanent diagnostics	14
3.3	Output DC offset detection	15
3.4	AC diagnostic	15
4	Multiple faults	17
4.1	Faults availability	17
5	Thermal protection	18
6	Fast muting	19
7	Address selection and I²C disable	20
8	I²C bus	21
8.1	I ² C programming/reading sequences	21
8.2	I ² C bus interface	21
8.2.1	Data validity	21
8.2.2	Start and stop conditions	21
8.2.3	Byte format	21
8.2.4	Acknowledge	22
9	Software specifications	23
10	Examples of bytes sequence	27

11	Package information	28
12	Revision history	29

List of tables

Table 2.	Absolute maximum ratings	8
Table 3.	Thermal Data	8
Table 4.	Electrical characteristics	8
Table 5.	Double fault table for turn-on diagnostic	17
Table 6.	IB1	23
Table 7.	IB2	23
Table 8.	DB1	24
Table 9.	DB2	25
Table 10.	DB3	25
Table 11.	DB4	26
Table 12.	Document revision history	29

List of figures

Figure 1.	Block diagram	6
Figure 2.	Application diagram	7
Figure 3.	Pins connection diagram (top of view)	7
Figure 4.	ITU R-ARM frequency response, weighting filter for transient pop.	11
Figure 5.	Turn-on diagnostic: working principle	12
Figure 6.	SVR and output behavior (case 1: without turn-on diagnostic).	12
Figure 7.	SVR and output pin behavior (case 2: with turn-on diagnostic)	13
Figure 8.	Short circuit detection thresholds	13
Figure 9.	Load detection thresholds - high gain setting 26 dB.	13
Figure 10.	Load detection thresholds - low gain setting 16 dB	13
Figure 11.	Restart timing without diagnostic enable (permanent)	14
Figure 12.	Restart timing with diagnostic enable (permanent).	14
Figure 13.	Current detection high: load impedance Z vs. output peak voltage	16
Figure 14.	Current detection low: load impedance Z vs. output peak voltage	16
Figure 15.	Thermal foldback diagram	18
Figure 16.	Data validity on the I ² C bus	22
Figure 17.	Timing diagram on the I ² C bus	22
Figure 18.	Acknowledge on the I ² C bus	22
Figure 19.	PowerSO36 (slug up) mechanical data and package dimensions	28

1 Block, application and pins connection diagrams

Figure 1. Block diagram

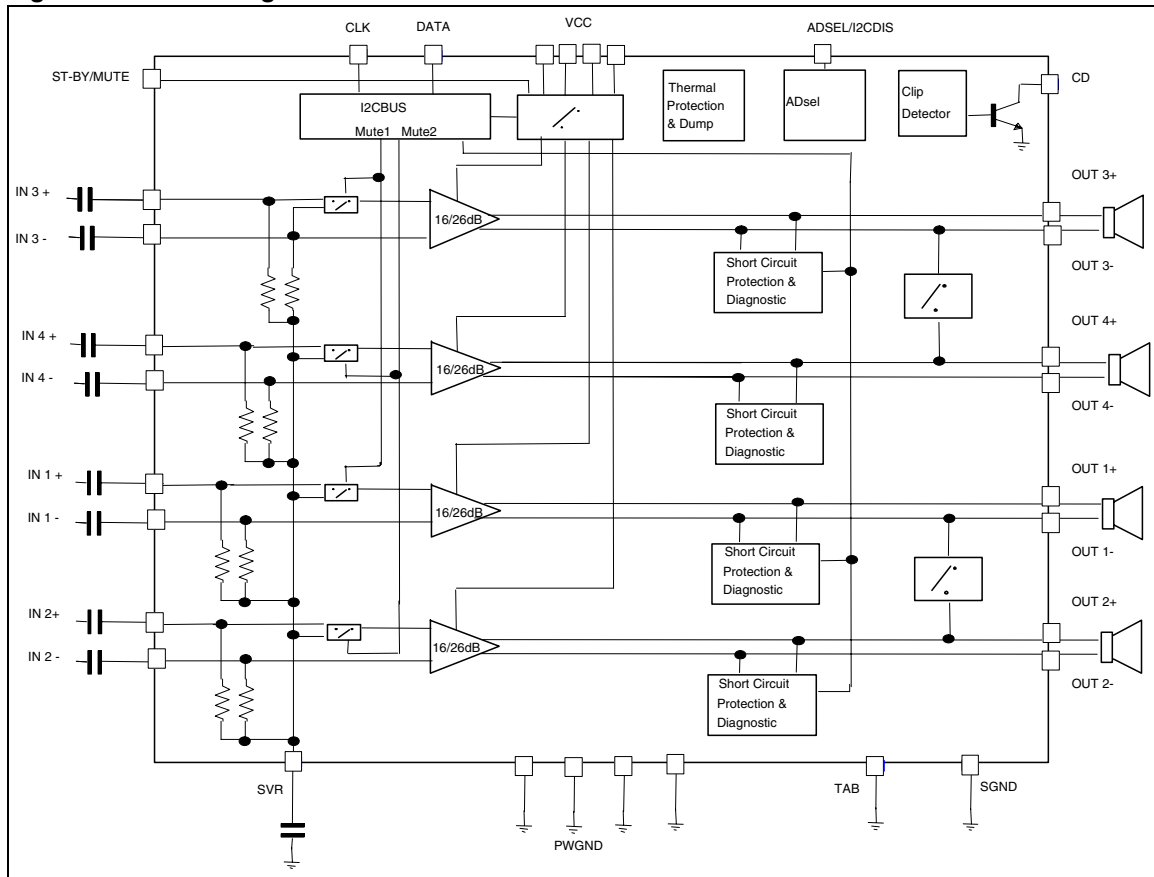

Figure 2. Application diagram

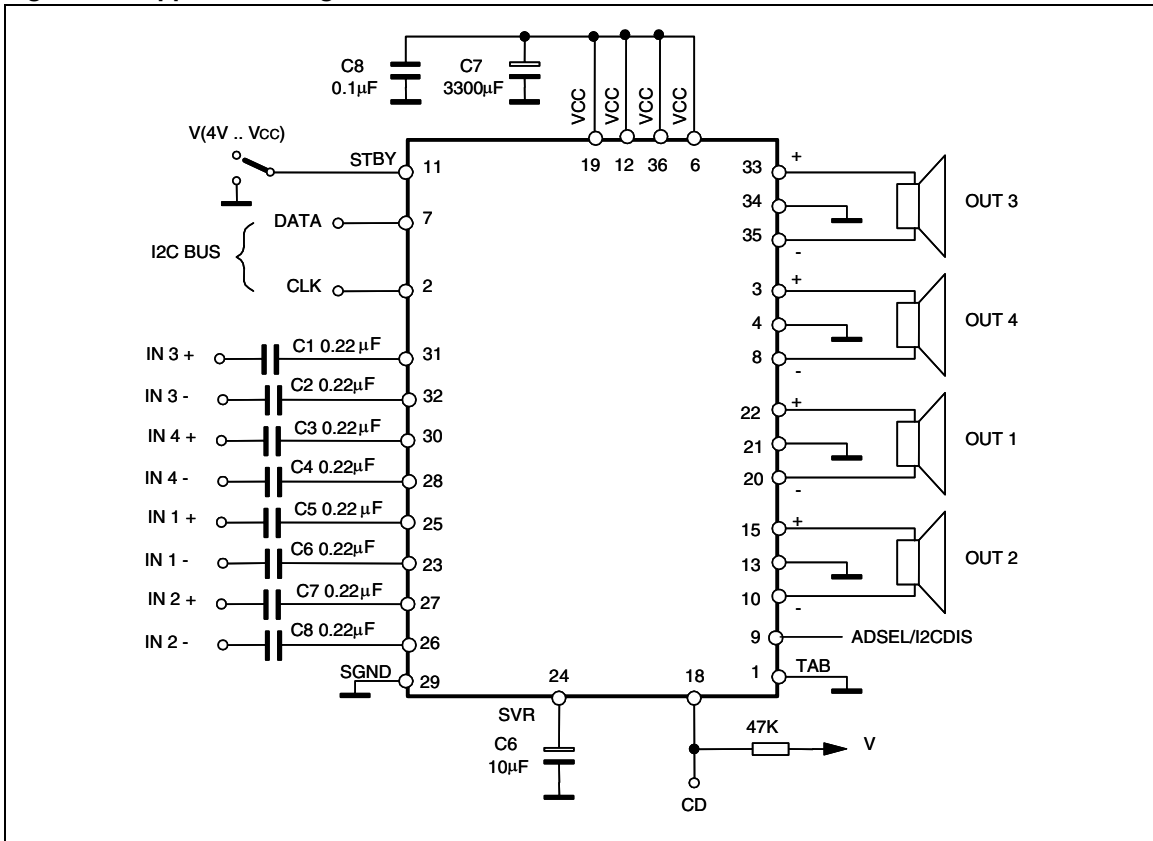
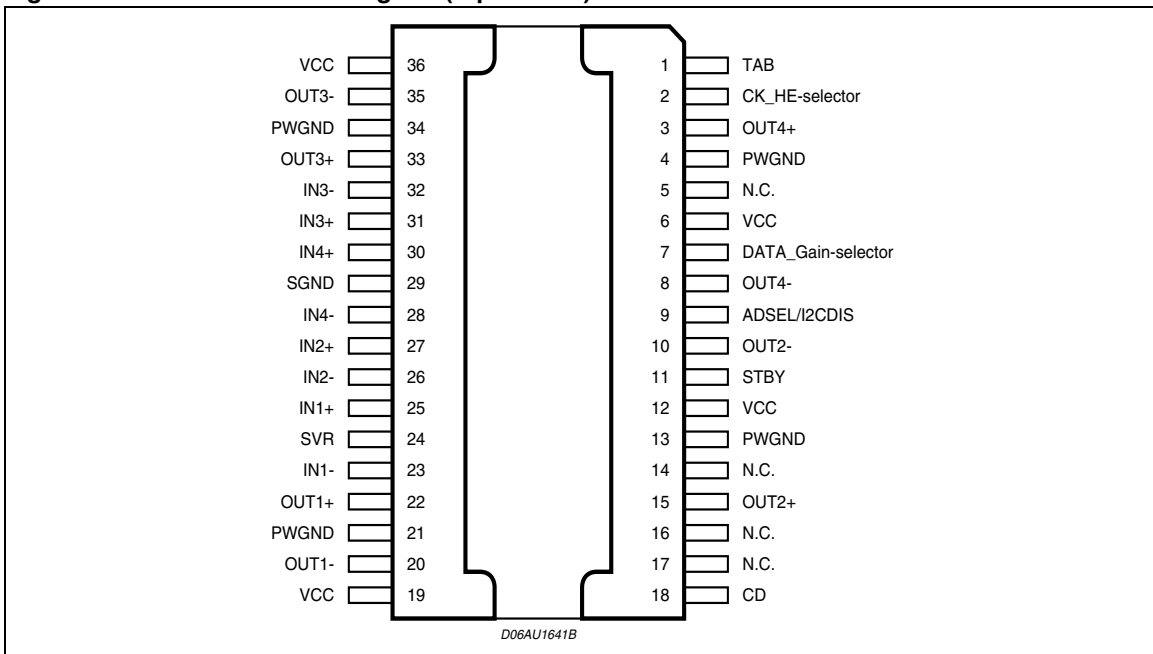

Figure 3. Pins connection diagram (top of view)



2 Electrical specifications

2.1 Absolute maximum ratings

Table 2. Absolute maximum ratings

Symbol	Parameter	Value	Unit
V_{op}	Operating supply voltage	18	V
V_S	DC supply voltage	28	V
V_{peak}	Peak supply voltage (for $t = 50$ ms)	50	V
V_{CK}	CK pin voltage	6	V
V_{DATA}	Data pin voltage	6	V
I_O	Output peak current (not repetitive $t = 100$ ms)	8	A
I_O	Output peak current (repetitive $f > 10$ Hz)	6	A
P_{tot}	Power dissipation $T_{case} = 70$ °C	85	W
T_{stg}, T_j	Storage and junction temperature	-55 to 150	°C

2.2 Thermal data

Table 3. Thermal Data

Symbol	Parameter	Value	Unit
$R_{th\ j-case}$	Thermal resistance junction-to-case	Max. 1	°C/W

2.3 Electrical characteristics

Refer to the test circuit, $V_S = 14.4$ V; $R_L = 4$ Ω ; $f = 1$ kHz; $G_V = 26$ dB; $T_{amb} = 25$ °C; unless otherwise specified.

Table 4. Electrical characteristics

Symbol	Parameter	Test condition	Min.	Typ.	Max.	Unit
Power amplifier						
V_S	Supply voltage range	-	8	-	18	V
I_d	Total quiescent drain current	-	-	180	300	mA
P_O	Output power	MAX power ($V_S = 15.2$ V, square wave input (2 V_{rms}))	-	50	-	W
		THD = 10 %	25	28	-	W
		THD = 1 %	20	22	-	W
		$R_L = 2$ Ω ; THD 10 %	-	50	-	W
	$R_L = 2$ Ω ; THD 1 %	-	40	-	W	
	$R_L = 2$ Ω ; max. power	-	75	-	W	

Table 4. Electrical characteristics (continued)

Symbol	Parameter	Test condition	Min.	Typ.	Max.	Unit
THD	Total harmonic distortion	$P_O = 1 \text{ W to } 10 \text{ W}$; STD MODE	-	0.03	0.1	%
		HE MODE; $P_O = 1.5 \text{ W}$	-	0.02	0.1	%
		HE MODE; $P_O = 8 \text{ W}$	-	0.15	0.8	%
		$P_O = 1\text{-}10 \text{ W}$, $f = 10 \text{ kHz}$	-	0.2	0.5	%
		$G_V = 16 \text{ dB}$; STD Mode $V_O = 0.1 \text{ to } 5 V_{RMS}$	-	0.02	0.05	%
C_T	Cross talk	$f = 1 \text{ kHz to } 10 \text{ kHz}$, $R_g = 600 \Omega$	50	60	-	dB
R_{IN}	Input Impedance	-	60	100	130	$K\Omega$
G_{V1}	Voltage gain 1	-	25	26	27	dB
ΔG_{V1}	Voltage gain match 1	-	-1	-	1	dB
G_{V2}	Voltage gain 2	-	15	16	17	dB
ΔG_{V2}	Voltage gain match 2	-	-1	-	1	dB
E_{IN1}	Output noise voltage 1	$R_g = 600 \Omega$ 20 Hz to 22 kHz	-	-	100	μV
E_{IN2}	Output noise voltage 2	$R_g = 600 \Omega$; $G_V = 16 \text{ dB}$ 20 Hz to 22 kHz	-	-	30	μV
SVR	Supply voltage rejection	$f = 100 \text{ Hz to } 10 \text{ kHz}$; $V_r = 1 \text{ Vpk}$; $R_g = 600 \Omega$	50	60	-	dB
BW	Power bandwidth	-	100	-	-	KHz
A_{SB}	Standby attenuation	-	90	110	-	dB
I_{SB}	Standby current	$V_{st-by} = 0$	-	1	10	μA
A_M	Mute attenuation	-	80	100	-	dB
V_{OS}	Offset voltage	Mute and play	-70	0	70	mV
V_{AM}	Min. supply mute threshold	-	7	7.5	8	V
T_{ON}	Turn ON delay	D2/D1 (IB1) 0 to 1	-	15	40	ms
T_{OFF}	Turn OFF delay	D2/D1 (IB1) 1 to 0	-	15	40	ms
V_{SBY}	Standby/mute pin for standby	-	0	-	1.5	V
V_{MU}	Standby/mute pin for mute	-	3.5	-	5	V
V_{OP}	Standby/mute pin for operating	-	7	-	V_S	V
I_{MU}	Standby/mute pin current	$V_{st-by/mute} = 8.5 \text{ V}$	-	20	40	μA
		$V_{st-by/mute} < 1.5 \text{ V}$	-	0	5	μA
CD_{LK}	Clip det high leakage current	CD off / $V_{CD} = 6 \text{ V}$	-	0	5	μA
CD_{SAT}	Clip det sat. voltage	CD on; $I_{CD} = 1 \text{ mA}$	-	-	300	mV
CD_{THD}	Clip det THD level	D0 (IB1) = 1	5	10	15	%
		D0 (IB1) = 0	1	2	3.5	%

Table 4. Electrical characteristics (continued)

Symbol	Parameter	Test condition	Min.	Typ.	Max.	Unit
ΔV_{OS}	During mute ON/OFF output offset voltage	ITU R-ARM weighted (full wave rectified, standby pin linear transition = 5.55 V to 6.45 V in 80 ms, @25 °C, $V_S = 14.4V$) see Figure 4	-7.5	-	+7.5	mV
	During standby ON/OFF output offset voltage		-7.5	-	+7.5	mV
CK_HE	STD mode selector	ADSEL pin floating	-	-	1.5	V
	HE mode selector	ADSEL pin floating	2.3	-		V
DATA_gain	High gain selector	ADSEL pin floating		-	1.5	V
	Low gain selector	ADSEL pin floating	2.3	-	-	V
Turn on diagnostics 1 (power amplifier mode)						
Pgnd	Short to GND det. (Below this limit, the output is considered in short circuit to GND)	Power amplifier in standby	-	-	1.2	V
Pvs	Short to V_S det. (Above this limit, the output is considered in short circuit to V_S)		$V_S - 1.2$	-	-	V
Pnop	Normal operation thresholds. (Within these limits, the output is considered without faults).		1.8	-	$V_S - 1.8$	V
Lsc	Shorted load det.		-	-	0.5	Ω
Lop	Open load det.		85	-		Ω
Lnop	Normal load det.		1.5	-	45	Ω
Turn on diagnostics 2 (line driver mode)						
Pgnd	Short to GND det. (Below this limit, the output is considered in short circuit to GND)	Power amplifier in standby	-	-	1.2	V
Pvs	Short to V_S det. (Above this limit, the output is considered in short circuit to V_S)	-	$V_S - 1.2$	-	-	V
Pnop	Normal operation thresholds. (Within these limits, the output is considered without faults).	-	1.8	-	$V_S - 1.8$	V
Lsc	Shorted Load det.	-	-	-	1.5	Ω
Lop	Open Load det.	-	330	-	-	Ω
Lnop	Normal Load det.	-	7	-	180	Ω
Permanent diagnostics 2 (Power amplifier mode or line driver mode)						
Pgnd	Short to GND det. (Below this limit, the output is considered in short circuit to GND)	Power amplifier in mute or play, one or more short circuits protection activated	-	-	1.2	V

Table 4. Electrical characteristics (continued)

Symbol	Parameter	Test condition	Min.	Typ.	Max.	Unit
Pvs	Short to Vs det. (Above this limit, the output is considered in short circuit to VS)	Power amplifier in mute or play, one or more short circuits protection activated	Vs -1.2	-	-	V
Pnop	Normal operation thresholds. (Within these limits, the output is considered without faults).		1.8	-	Vs -1.8	V
L _{SC}	Shorted load det.	Power amplifier mode	-	-	0.5	Ω
		Line driver mode	-	-	1.5	Ω
V _O	Offset detection	Power amplifier in play, AC Input signals = 0	±1.5	±2	±2.5	V
I _{NLH}	Normal load current detection	V _O < (V _S - 5)pk IB2 (D7) = 0	500	-	-	mA
I _{NLL}	Normal load current detection	V _O < (V _S - 5)pk IB2 (D7) = 1	300	-	-	mA
I _{OLH}	Open load current detection	V _O < (V _S - 5)pk IB2 (D7) = 0	-	-	250	mA
I _{OLL}	Open load current detection	V _O < (V _S - 5)pk IB2 (D7) = 1	-	-	125	mA
I²C bus interface						
S _{CL}	Clock frequency	-	-	-	400	kHz
V _{IL}	Input low voltage	-	-	-	1.5	V
V _{IH}	Input high voltage	-	2.3	-	-	V

Figure 4. ITU R-ARM frequency response, weighting filter for transient pop

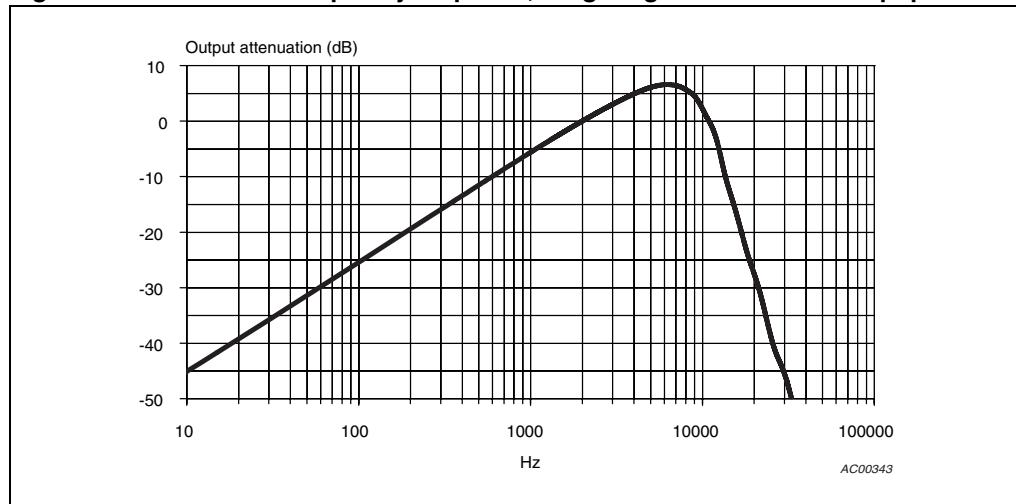

3 Diagnostics functional description

3.1 Turn-on diagnostic

It is activated at the turn-on (standby out) under I²C bus request. Detectable output faults are:

- Short to GND
- Short to V_s
- Short across the speaker
- Open speaker

To verify if any of the above misconnections are in place, a subsonic (inaudible) current pulse (Figure 5) is internally generated, sent through the speaker(s) and sunk back. The turn-on diagnostic status is internally stored until a successive diagnostic pulse is requested (after a I²C reading).

If the "standby out" and "diagnostic enable" commands are both given through a single programming step, the pulse takes place first (power stage still in standby mode, low, outputs= high impedance).

Afterwards, when the amplifier is biased, the PERMANENT diagnostic takes place. The previous turn-on state is kept until a short appears at the outputs.

Figure 5. Turn-on diagnostic: working principle

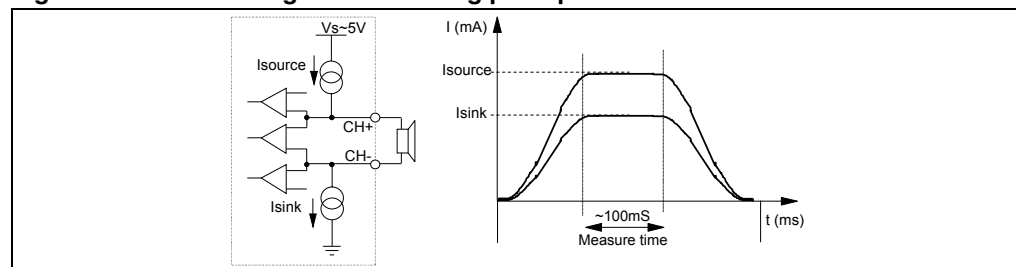

Figure 6 and 7 show SVR and output waveforms at the turn-on (standby out) with and without turn-on diagnostic.

Figure 6. SVR and output behavior (case 1: without turn-on diagnostic)

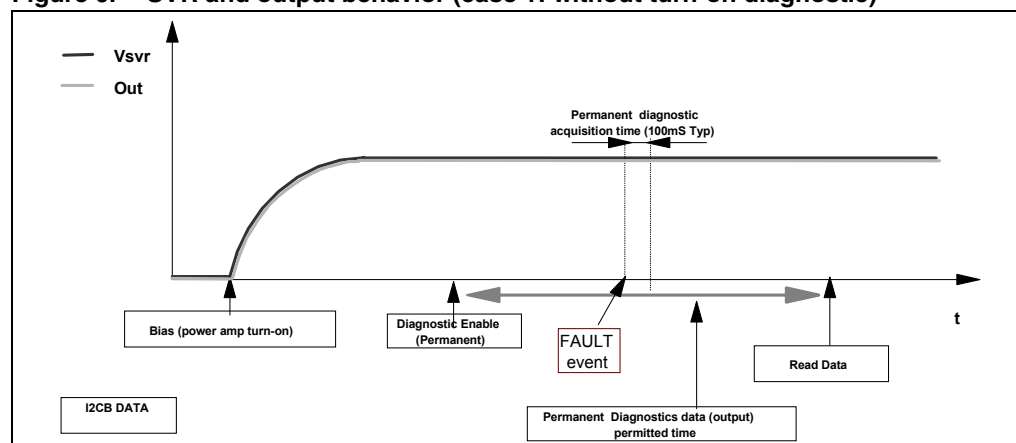
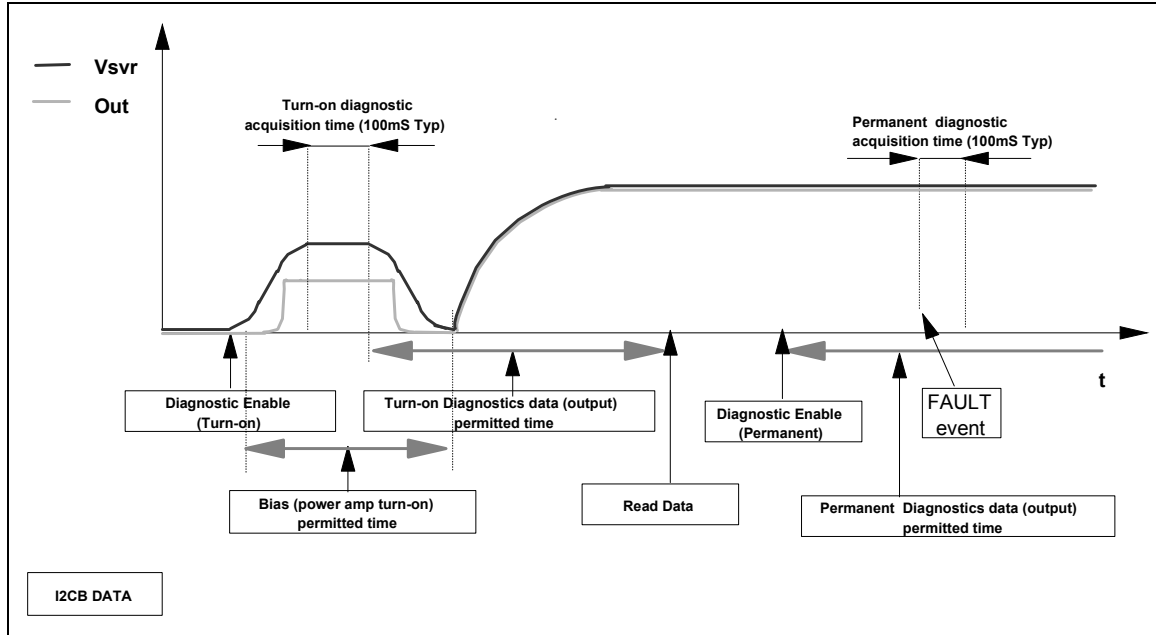
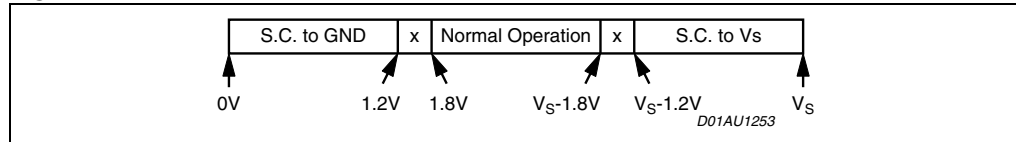

Figure 7. SVR and output pin behavior (case 2: with turn-on diagnostic)



The information related to the outputs status is read and memorized at the end of the current pulse top. The acquisition time is 100 ms (typ.). No audible noise is generated in the process. As for short to GND / Vs the fault-detection thresholds remain unchanged from 26 dB to 16 dB gain setting. They are as follows:

Figure 8. Short circuit detection thresholds



Concerning short across the speaker / open speaker, the threshold varies from 26 dB to 16 dB gain setting, since different loads are expected (either normal speaker's impedance or high impedance). The values in case of 26 dB gain are as follows:

Figure 9. Load detection thresholds - high gain setting 26 dB

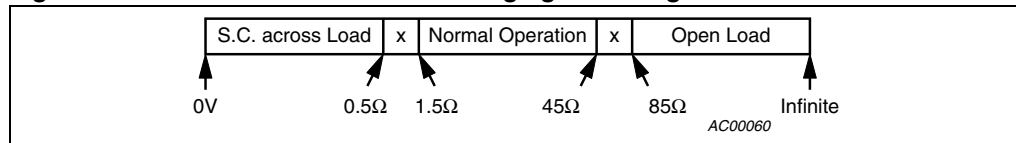

If the line driver mode ($G_v = 16$ dB and line driver mode diagnostic = 1) is selected, the same thresholds will change as follows:

Figure 10. Load detection thresholds - low gain setting 16 dB

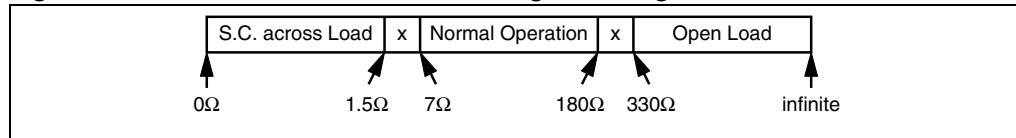

3.2 Permanent diagnostics

Detectable conventional faults are:

- Short to GND
- Short to Vs
- Short across the speaker

The following additional features are provided:

- Output offset detection

The TDA7567PD has 2 operating status:

1. RESTART mode. The diagnostic is not enabled. Each audio channel operates independently from each other. If any of the a.m. faults occurs, only the channel(s) interested is shut down. A check of the output status is made every 1 ms (*Figure 11*). Restart takes place when the overload is removed.
2. DIAGNOSTIC mode. It is enabled via I²C bus and self activates if an output overload (such to cause the intervention of the short-circuit protection) occurs to the speakers outputs. Once activated, the diagnostics procedure develops as follows (*Figure 12*):
 - To avoid momentary re-circulation spikes from giving erroneous diagnostics, a check of the output status is made after 1ms: if normal situation (no overloads) is detected, the diagnostic is not performed and the channel returns back active.
 - Instead, if an overload is detected during the check after 1 ms, then a diagnostic cycle having a duration of about 100 ms is started.
 - After a diagnostic cycle, the audio channel interested by the fault is switched to RESTART mode. The relevant data are stored inside the device and can be read by the microprocessor. When one cycle has terminated, the next one is activated by an I²C reading. This is to ensure continuous diagnostics throughout the car-radio operating time.
 - To check the status of the device a sampling system is needed. The timing is chosen at microprocessor level (over half a second is recommended).

Figure 11. Restart timing without diagnostic enable (permanent) - Each 1ms time, a sampling of the fault is done

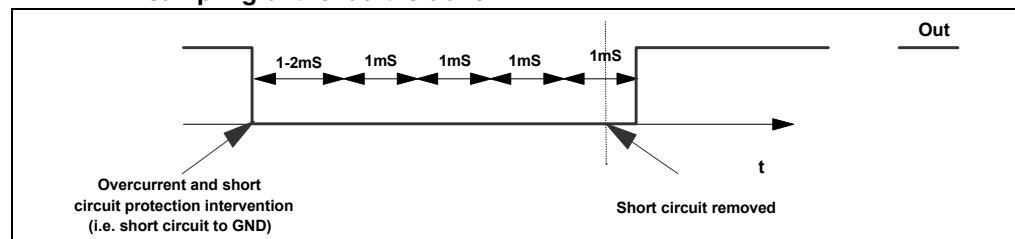
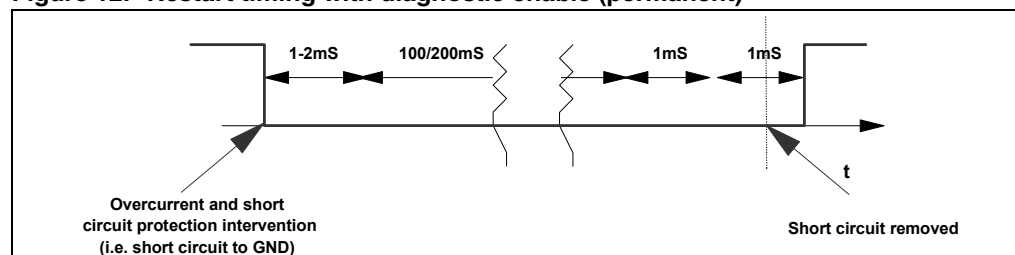

Figure 12. Restart timing with diagnostic enable (permanent)



3.3 Output DC offset detection

Any DC output offset exceeding ± 2 V are signalled out. This inconvenient might occur as a consequence of initially defective or aged and worn-out input capacitors feeding a DC component to the inputs, so putting the speakers at risk of overheating.

This diagnostic has to be performed with low-level output AC signal (or $V_{in} = 0$).

The test is run with selectable time duration by microprocessor (from a "start" to a "stop" command):

- START = Last reading operation or setting IB1 - D5 - (OFFSET enable) to 1
- STOP = Actual reading operation

Excess offset is signalled out if persistent throughout the assigned testing time. This feature is disabled if any overloads leading to activation of the short-circuit protection occurs in the process.

3.4 AC diagnostic

It is targeted at detecting accidental disconnection of tweeters in 2-way speaker and, more in general, presence of capacitively (AC) coupled loads.

This diagnostic is based on the notion that the overall speaker's impedance (woofer + parallel tweeter) will tend to increase towards high frequencies if the tweeter gets disconnected, because the remaining speaker (woofer) would be out of its operating range (high impedance). The diagnostic decision is made according to peak output current thresholds, and it is enabled by setting (IB2-D2) = 1.

Two different detection levels are available:

- High current threshold IB2 (D7) = 0
 - $I_{out} > 500$ mApk = NORMAL STATUS
 - $I_{out} < 300$ mApk = OPEN TWEETER
- Low current threshold IB2 (D7) = 1
 - $I_{out} > 250$ mApk = NORMAL STATUS
 - $I_{out} < 125$ mApk = OPEN TWEETER

To correctly implement this feature, it is necessary to briefly provide a signal tone (with the amplifier in "play") whose frequency and magnitude are such to determine an output current higher than 500 mApk with IB2(D7)=0 (higher than 250 mApk with IB2(D7)=1) in normal conditions and lower than 250 mApk with IB2(D7)=0 (lower than 125 mApk with IB2(D7)=1) should the parallel tweeter be missing.

The test has to last for a minimum number of 3 sine cycles starting from the activation of the AC diagnostic function IB2<D2>) up to the I²C reading of the results (measuring period). To confirm presence of tweeter, it is necessary to find at least 3 current pulses over the above thresholds over all the measuring period, else an "open tweeter" message will be issued.

The frequency / magnitude setting of the test tone depends on the impedance characteristics of each specific speaker being used, with or without the tweeter connected (to be calculated case by case). High-frequency tones (> 10 kHz) or even ultrasonic signals are recommended for their negligible acoustic impact and also to maximize the impedance module's ratio between with tweeter-on and tweeter-off.

Figure 13 shows the load impedance as a function of the peak output voltage and the relevant diagnostic fields. This feature is disabled if any overloads leading to activation of the short-circuit protection occurs in the process.

Figure 13. Current detection high: load impedance |Z| vs. output peak voltage

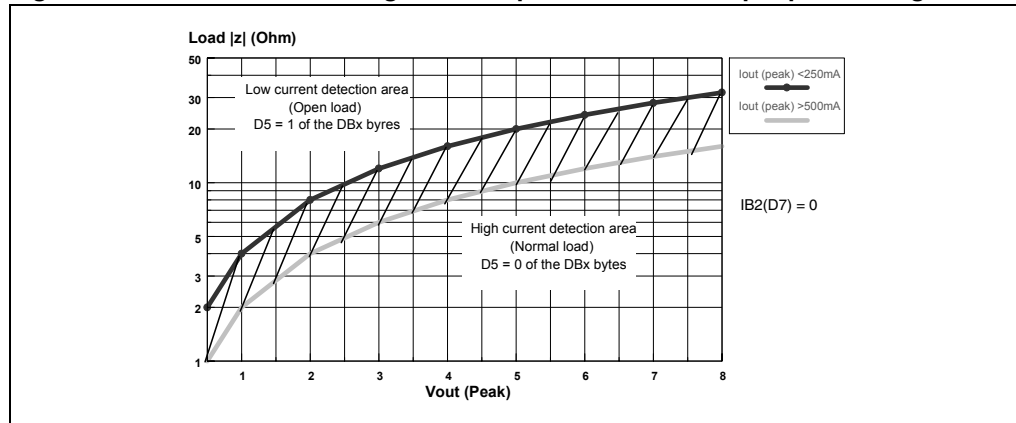
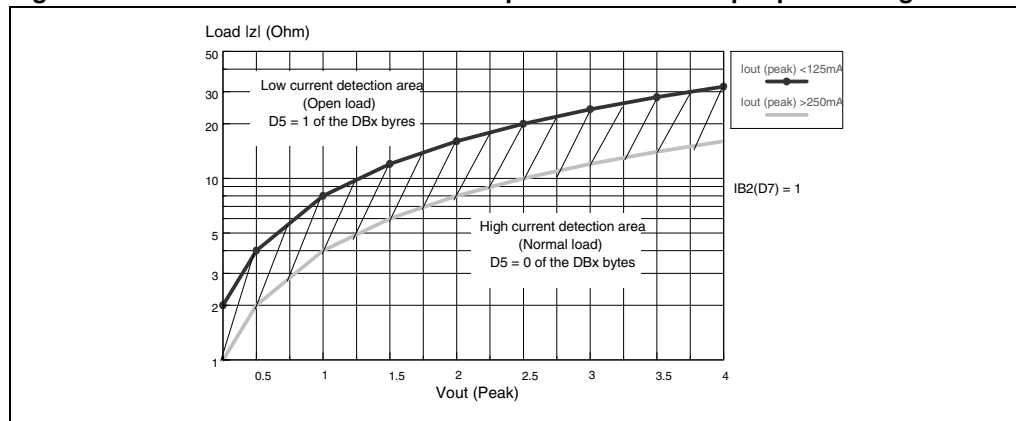

Figure 14. Current detection low: load impedance |Z| vs. output peak voltage



4 Multiple faults

When more misconnections are simultaneously in place at the audio outputs, it is guaranteed that at least one of them is initially read out. The others are notified after successive cycles of I²C reading and faults removal, provided that the diagnostic is enabled. This is true for both kinds of diagnostic (Turn-on and Permanent).

The table below shows all the couples of double-fault possible. It should be taken into account that a short circuit with the 4 ohm speaker unconnected is considered as double fault.

Table 5. Double fault table for turn-on diagnostic

	S. GND (so)	S. GND (sk)	S. Vs	S. Across L.	Open L.
S. GND (so)	S. GND	S. GND	S. Vs + S. GND	S. GND	S. GND
S. GND (sk)	/	S. GND	S. Vs	S. GND	Open L. (*)
S. Vs	/	/	S. Vs	S. Vs	S. Vs
S. Across L.	/	/	/	S. Across L.	N.A.
Open L.	/	/	/	/	Open L. (*)

S. GND (so) / S. GND (sk) in the above table make a distinction according to which of the 2 outputs is shorted to ground (test-current source side= so, test-current sink side = sk). More precisely, in Channels CH3 and CH2, so = CH+, sk = CH-; in Channels CH4 and CH1, so = CH-, sk = CH+.

In Permanent Diagnostic the table is the same, with only a difference concerning Open Load(*), which is not among the recognizable faults. Should an Open Load be present during the device's normal working, it would be detected at a subsequent Turn on Diagnostic cycle (i.e. at the successive Car Radio Turn on).

4.1 Faults availability

All the results coming from I²C bus, by read operations, are the consequence of measurements inside a defined period of time. If the fault is stable throughout the whole period, it will be sent out.

To guarantee always resident functions, every kind of diagnostic cycles (Turn on, Permanent, Offset) will be reactivate after any I²C reading operation. So, when the micro reads the I²C, a new cycle will be able to start, but the read data will come from the previous diag. cycle (i.e. The device is in turn-on state, with a short to GND, then the short is removed and micro reads I²C. The short to GND is still present in bytes, because it is the result of the previous cycle. If another I²C reading operation occurs, the bytes do not show the short). In general to observe a change in Diagnostic bytes, two I²C reading operations are necessary.

5 Thermal protection

Thermal protection is implemented through thermal foldback (*Figure 15*).

Thermal foldback begins limiting the audio input to the amplifier stage as the junction temperatures rise above the normal operating range. This effectively limits the output power capability of the device thus reducing the temperature to acceptable levels without totally interrupting the operation of the device.

The output power will decrease to the point at which thermal equilibrium is reached. Thermal equilibrium will be reached when the reduction in output power reduces the dissipated power such that the die temperature falls below the thermal foldback threshold. Should the device cool, the audio level will increase until a new thermal equilibrium is reached or the amplifier reaches full power. Thermal foldback will reduce the audio output level in a linear manner.

Three Thermal warning are available through the I²C bus data.

Figure 15. Thermal foldback diagram

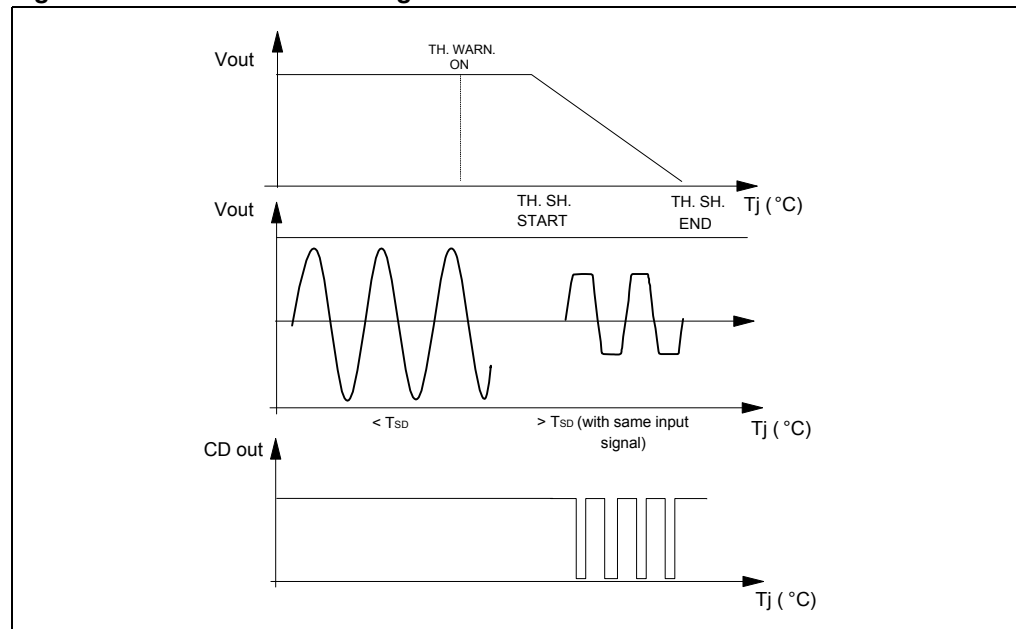

6 Fast muting

The muting time can be shortened to less than 1.5 ms by setting (IB2) D5 = 1. This option can be useful in transient battery situations (i.e. during car engine cranking) to quickly turnoff the amplifier for avoiding any audible effects caused by noise/transients being injected by preamp stages. The bit must be set back to "0" shortly after the mute transition.

7 Address selection and I²C disable

When the ADSEL/I2CDIS pin is left open the I²C bus is disabled and the device can be controlled by the STBY/MUTE pin.

In this status (no - I²C bus) the CK pin enables the HIGH-EFFICIENCY MODE (0 = STD MODE; 1 = HE MODE) and the DATA pin sets the gain (0 = 26 dB; 1 = 16 dB).

When the ADSEL/I2CDIS pin is connected to GND the I²C bus is active with address <1101100-1>.

To select the other I²C address a resistor must be connected to ADSEL/I2CDIS pin as following:

0 < R < ~10k Ω : I²C bus active with address <1101100x>

~25k < R < 35k Ω : I²C bus active with address <1101101x>

R > 60k: Legacy mode only

(x: read/write bit selector)

8 I²C bus

8.1 I²C programming/reading sequences

A correct turn on/off sequence respectful of the diagnostic timings and producing no audible noises could be as follows (after battery connection):

- Turn-on: Pin2 > 7V --- 10 ms --- (STANDBY OUT + DIAG ENABLE) --- 500 ms (min) --- MUTING OUT
- Turn-off: MUTING IN --- 20 ms --- (DIAG DISABLE + STANDBY IN) --- 10 ms --- PIN2 = 0
- Car radio installation: Pin2 > 7V --- 10ms DIAG ENABLE (write) --- 200 ms --- I²C read (repeat until All faults disappear).
- Offset test: Device in Play (no signal) -- OFFSET ENABLE - 30 ms - I²C reading (repeat I²C reading until high-offset message disappears).

8.2 I²C bus interface

Data transmission from microprocessor to the TDA7567PD and viceversa takes place through the 2 wires I²C bus interface, consisting of the two lines SDA and SCL (pull-up resistors to positive supply voltage must be connected).

8.2.1 Data validity

As shown by [Figure 16](#), the data on the SDA line must be stable during the high period of the clock. The HIGH and LOW state of the data line can only change when the clock signal on the SCL line is LOW.

8.2.2 Start and stop conditions

As shown by [Figure 17](#) a start condition is a HIGH to LOW transition of the SDA line while SCL is HIGH. The stop condition is a LOW to HIGH transition of the SDA line while SCL is HIGH.

8.2.3 Byte format

Every byte transferred to the SDA line must contain 8 bits. Each byte must be followed by an acknowledge bit. The MSB is transferred first.

8.2.4 Acknowledge

The **transmitter** puts a resistive high level on the SDA line during the acknowledge clock pulse (see [Figure 18](#)). The **receiver** the acknowledges has to pull-down (low) the SDA line during the acknowledge clock pulse, so that the SDA line is stable low during this clock pulse.

Transmitter:

- master (μ P) when it writes an address to the TDA7567PD
- slave (TDA7567PD) when the μ P reads a data byte from TDA7567PD

Receiver:

- slave (TDA7567PD) when the μ P writes an address to the TDA7567PD
- master (μ P) when it reads a data byte from TDA7567PD

Figure 16. Data validity on the I²C bus

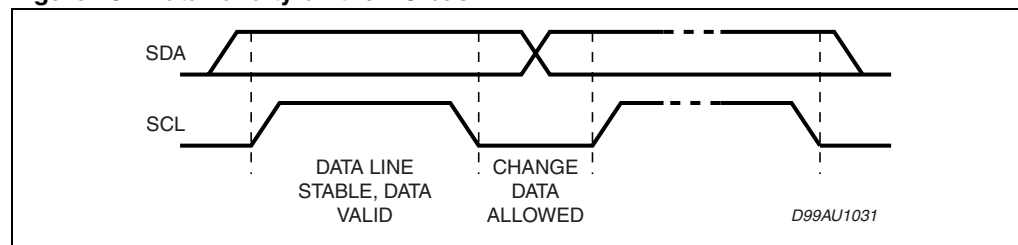

Figure 17. Timing diagram on the I²C bus

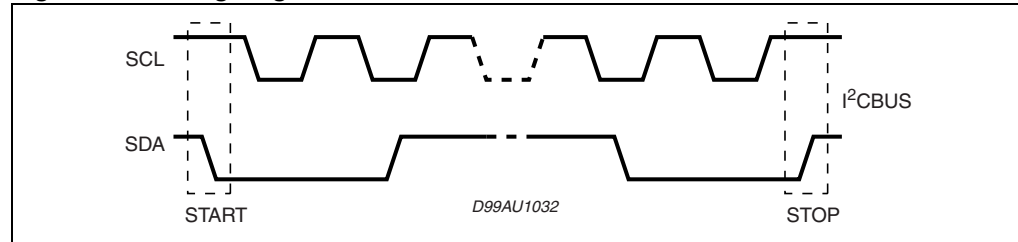
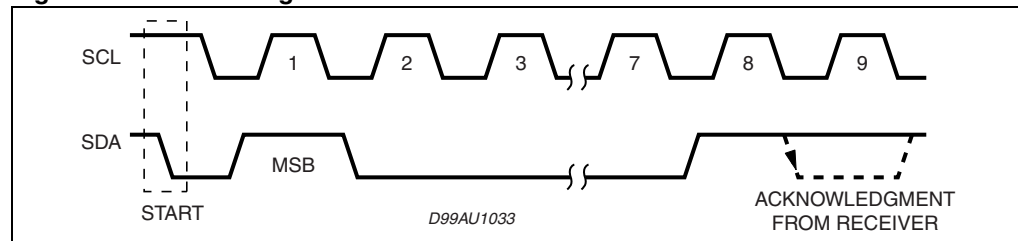

Figure 18. Acknowledge on the I²C bus



9 Software specifications

All the functions of the TDA7567PD are activated by I²C interface.

The bit 0 of the "Address Byte" defines if the next bytes are write instruction (from μ P to TDA7567PD) or read instruction (from TDA7567PD to μ P).

Chip address

D7	1	1	0	1	1	0	(1)	X	D8 Hex
----	---	---	---	---	---	---	-----	---	--------

1. Address selector bit, please refer to address selection description on [Chapter 7](#).

X = 0 Write to device

X = 1 Read from device

If R/W = 0, the μ P sends 2 "Instruction Bytes": IB1 and IB2.

Table 6. IB1

Bit	Instruction decoding bit
D7	0
D6	Diagnostic enable (D6 = 1) Diagnostic defeat (D6 = 0)
D5	Offset detection enable (D5 = 1) Offset detection defeat (D5 = 0)
D4	Front channel Gain = 26 dB (D4 = 0) Gain = 16 dB (D4 = 1)
D3	Rear channel Gain = 26dB (D3 = 0) Gain = 16dB (D3 = 1)
D2	Mute front channels (D2 = 0) Unmute front channels (D2 = 1)
D1	Mute rear channels (D1 = 0) Unmute rear channels (D1 = 1)
D0	CD 2% (D0 = 0) CD 10% (D0 = 1)

Table 7. IB2

Bit	Instruction decoding bit
D7	Current detection threshold High th (D7 = 0) Low th (D7 = 1)
D6	0

Table 7. IB2 (continued)

Bit	Instruction decoding bit
D5	Normal muting time (D5 = 0) Fast muting time (D5 = 1)
D4	Standby on - Amplifier not working - (D4 = 0) Standby off - Amplifier working - (D4 = 1)
D3	Power amplifier mode diagnostic (D3 = 0) Line driver mode diagnostic (D3 = 1)
D2	Current detection diagnostic enabled (D2 = 1) Current detection diagnostic defeat (D2 = 0)
D1	Right channel power amplifier working in standard mode (D1 = 0) Power amplifier working in high efficiency mode (D1 = 1)
D0	Left channel power amplifier working in standard mode (D0 = 0) Power amplifier working in high efficiency mode (D0 = 1)

If R/W = 1, the TDA7567PD sends 4 "Diagnostics Bytes" to μ P: DB1, DB2, DB3 and DB4.

Table 8. DB1

Bit	Instruction decoding bit		
D7	Thermal warning 1 active (D7 = 1) T = 140 °C		
D6	Diag. cycle not activated or not terminated (D6 = 0) Diag. cycle terminated (D6 = 1)		
D5	<table border="1"> <tr> <td>Channel CH3 current detection IB2 (D7) = 0 Output peak current < 300 mA - Open load (D5 = 1) Output peak current > 500 mA - Normal load (D5 = 0)</td> <td>Channel CH3 current detection IB2 (D7) = 1 Output peak current < 125 mA - Open load (D5 = 1) Output peak current > 250 mA - Normal load (D5 = 0)</td> </tr> </table>	Channel CH3 current detection IB2 (D7) = 0 Output peak current < 300 mA - Open load (D5 = 1) Output peak current > 500 mA - Normal load (D5 = 0)	Channel CH3 current detection IB2 (D7) = 1 Output peak current < 125 mA - Open load (D5 = 1) Output peak current > 250 mA - Normal load (D5 = 0)
Channel CH3 current detection IB2 (D7) = 0 Output peak current < 300 mA - Open load (D5 = 1) Output peak current > 500 mA - Normal load (D5 = 0)	Channel CH3 current detection IB2 (D7) = 1 Output peak current < 125 mA - Open load (D5 = 1) Output peak current > 250 mA - Normal load (D5 = 0)		
D4	Channel CH3 Turn-on diagnostic (D4 = 0) Permanent diagnostic (D4 = 1)		
D3	Channel CH3 Normal load (D3 = 0) Short load (D3 = 1)		
D2	Channel CH3 Turn-on diag.: No open load (D2 = 0) Open load detection (D2 = 1) Offset diag.: No output offset (D2 = 0) Output offset detection (D2 = 1)		
D1	Channel CH3 No short to Vcc (D1 = 0) Short to Vcc (D1 = 1)		
D0	Channel CH3 No short to GND (D1 = 0) Short to GND (D1 = 1)		

Table 9. DB2

Bit	Instruction decoding bit	
D7	Offset detection not activated (D7 = 0) Offset detection activated (D7 = 1)	
D6	X	
D5	Channel CH4 current detection IB2 (D7) = 0 Output peak current < 300 mA - Open load (D5 = 1) Output peak current > 500 mA - Normal load (D5 = 0)	Channel CH4 current detection IB2 (D7) = 1 Output peak current < 125 mA - Open load (D5 = 1) Output peak current > 250 mA - Normal load (D5 = 0)
D4	Channel CH4 Turn-on diagnostic (D4 = 0) Permanent diagnostic (D4 = 1)	
D3	Channel CH4 Normal load (D3 = 0) Short load (D3 = 1)	
D2	Channel CH4 Turn-on diag.: No open load (D2 = 0) Open load detection (D2 = 1) Permanent diag.: No output offset (D2 = 0) Output offset detection (D2 = 1)	
D1	Channel CH4 No short to Vcc (D1 = 0) Short to Vcc (D1 = 1)	
D0	Channel CH4 No short to GND (D1 = 0) Short to GND (D1 = 1)	

Table 10. DB3

Bit	Instruction decoding bit	
D7	Standby status (= IB1 - D4)	
D6	Diagnostic status (= IB1 - D6)	
D5	Channel CH1 current detection IB2 (D7) = 0 Output peak current < 300 mA - Open load (D5 = 1) Output peak current > 500 mA - Normal load (D5 = 0)	Channel CH1 current detection IB2 (D7) = 1 Output peak current < 125 mA - Open load (D5 = 1) Output peak current > 250 mA - Normal load (D5 = 0)
D4	Channel CH1 Turn-on diagnostic (D4 = 0) Permanent diagnostic (D4 = 1)	
D3	Channel CH1 Normal load (D3 = 0) Short load (D3 = 1)	

Table 10. DB3 (continued)

Bit	Instruction decoding bit
D2	Channel CH1 Turn-on diag.: No open load (D2 = 0) Open load detection (D2 = 1) Permanent diag.: No output offset (D2 = 0) Output offset detection (D2 = 1)
D1	Channel CH1 No short to Vcc (D1 = 0) Short to Vcc (D1 = 1)
D0	Channel CH1 No short to GND (D1 = 0) Short to GND (D1 = 1)

Table 11. DB4

Bit	Instruction decoding bit		
D7	Thermal warning 2 active (D7 =1) $T_j = 133^\circ\text{C}$		
D6	Thermal warning 3 active (D6 =1) $T_j = 118^\circ\text{C}$		
D5	<table border="1"> <tr> <td>Channel CH2 current detection IB2 (D7) = 0 Output peak current < 300 mA - Open load (D5 = 1) Output peak current > 500 mA - Normal load (D5 = 0)</td> <td>Channel CH2 current detection IB2 (D7) = 1 Output peak current < 125mA - Open load (D5 = 1) Output peak current > 250 mA - Normal load (D5 = 0)</td> </tr> </table>	Channel CH2 current detection IB2 (D7) = 0 Output peak current < 300 mA - Open load (D5 = 1) Output peak current > 500 mA - Normal load (D5 = 0)	Channel CH2 current detection IB2 (D7) = 1 Output peak current < 125mA - Open load (D5 = 1) Output peak current > 250 mA - Normal load (D5 = 0)
Channel CH2 current detection IB2 (D7) = 0 Output peak current < 300 mA - Open load (D5 = 1) Output peak current > 500 mA - Normal load (D5 = 0)	Channel CH2 current detection IB2 (D7) = 1 Output peak current < 125mA - Open load (D5 = 1) Output peak current > 250 mA - Normal load (D5 = 0)		
D4	Channel CH2 Turn-on diagnostic (D4 = 0) Permanent diagnostic (D4 = 1)		
D3	Channel CH2 Normal load (D3 = 0) Short load (D3 = 1)		
D2	Channel CH2 Turn-on diag.: No open load (D2 = 0) Open load detection (D2 = 1) Permanent diag.: No output offset (D2 = 0) Output offset detection (D2 = 1)		
D1	Channel CH2 No short to Vcc (D1 = 0) Short to Vcc (D1 = 1)		
D0	Channel CH2 No short to GND (D1 = 0) Short to GND (D1 = 1)		

10 Examples of bytes sequence

1 - Turn-on diagnostic - Write operation

Start	Address byte with D0 = 0	ACK	IB1 with D6 = 1	ACK	IB2	ACK	STOP
-------	--------------------------	-----	-----------------	-----	-----	-----	------

2 - Turn-on diagnostic - Read operation

Start	Address byte with D0 = 1	ACK	DB1	ACK	DB2	ACK	DB3	ACK	DB4	ACK	STOP
-------	--------------------------	-----	-----	-----	-----	-----	-----	-----	-----	-----	------

The delay from 1 to 2 can be selected by software, starting from 200 ms

3a - Turn-on of the power amplifier with 26 dB gain, mute on, diagnostic defeat, CD = 2 %

Start	Address byte with D0 = 0	ACK	IB1	ACK	IB2	ACK	STOP
			X0000000		XXX1XX11		

3b - Turn-off of the power amplifier

Start	Address byte with D0 = 0	ACK	IB1	ACK	IB2	ACK	STOP
			X0XXXXXX		XXX0XXXX		

4 - Offset detection procedure enable

Start	Address byte with D0 = 0	ACK	IB1	ACK	IB2	ACK	STOP
			XX1XX11X		XXX1XXXX		

5 - Offset detection procedure stop and reading operation (the results are valid only for the offset detection bits (D2 of the bytes DB1, DB2, DB3, DB4))

Start	Address byte with D0 = 1	ACK	DB1	ACK	DB2	ACK	DB3	ACK	DB4	ACK	STOP
-------	--------------------------	-----	-----	-----	-----	-----	-----	-----	-----	-----	------

- The purpose of this test is to check if a D.C. offset (2 V typ.) is present on the outputs, produced by input capacitor with anomalous leakage current or humidity between pins.
- The delay from 4 to 5 can be selected by software, starting from 30 ms

11 Package information

In order to meet environmental requirements, ST offers these devices in different grades of ECOPACK® packages, depending on their level of environmental compliance. ECOPACK® specifications, grade definitions and product status are available at: www.st.com.

ECOPACK® is an ST trademark.

Figure 19. PowerSO36 (slug up) mechanical data and package dimensions

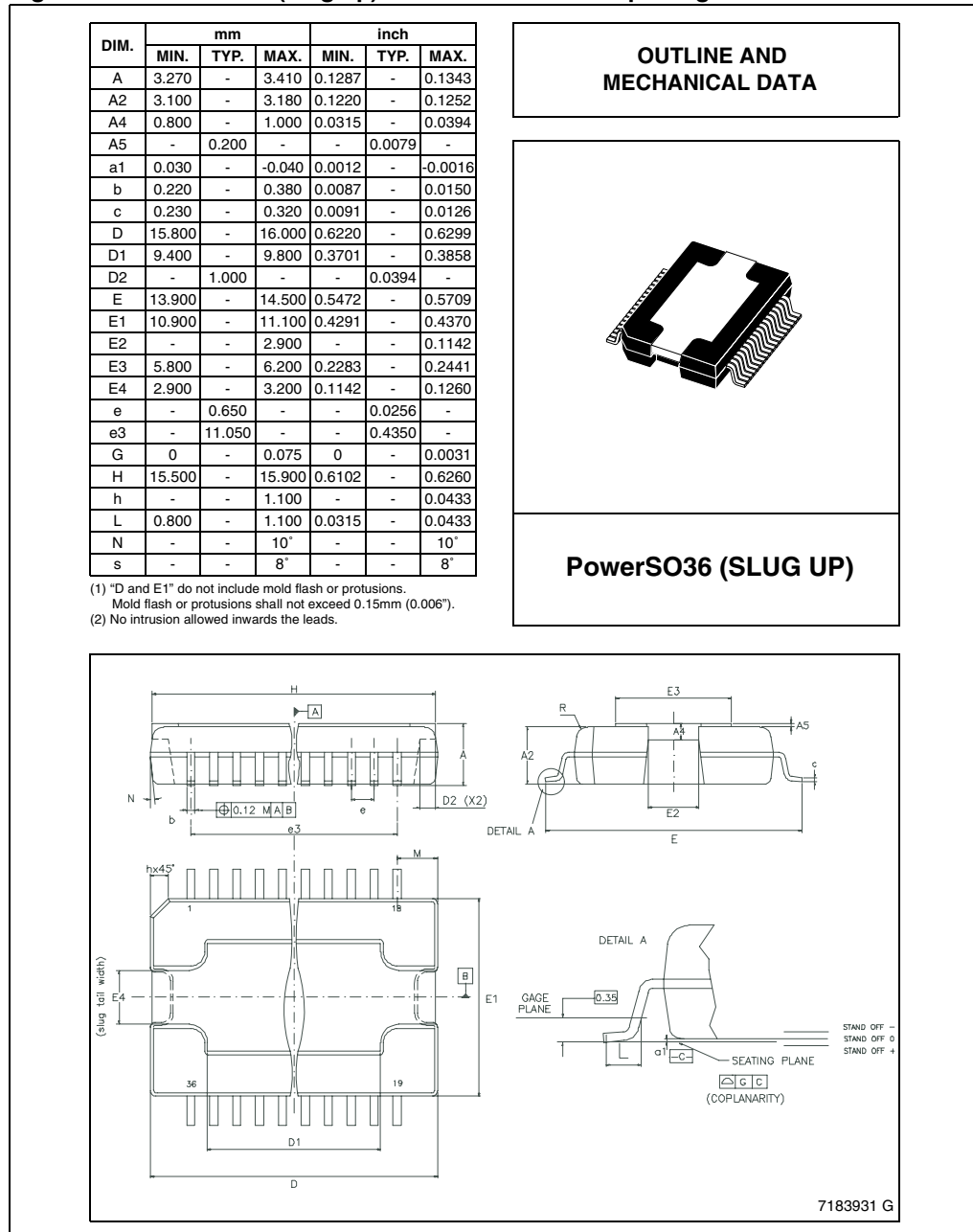

12 Revision history

Table 12. Document revision history

Date	Revision	Changes
11-Dec-2009	1	Initial release.

Please Read Carefully:

Information in this document is provided solely in connection with ST products. STMicroelectronics NV and its subsidiaries ("ST") reserve the right to make changes, corrections, modifications or improvements, to this document, and the products and services described herein at any time, without notice.

All ST products are sold pursuant to ST's terms and conditions of sale.

Purchasers are solely responsible for the choice, selection and use of the ST products and services described herein, and ST assumes no liability whatsoever relating to the choice, selection or use of the ST products and services described herein.

No license, express or implied, by estoppel or otherwise, to any intellectual property rights is granted under this document. If any part of this document refers to any third party products or services it shall not be deemed a license grant by ST for the use of such third party products or services, or any intellectual property contained therein or considered as a warranty covering the use in any manner whatsoever of such third party products or services or any intellectual property contained therein.

UNLESS OTHERWISE SET FORTH IN ST'S TERMS AND CONDITIONS OF SALE ST DISCLAIMS ANY EXPRESS OR IMPLIED WARRANTY WITH RESPECT TO THE USE AND/OR SALE OF ST PRODUCTS INCLUDING WITHOUT LIMITATION IMPLIED WARRANTIES OF MERCHANTABILITY, FITNESS FOR A PARTICULAR PURPOSE (AND THEIR EQUIVALENTS UNDER THE LAWS OF ANY JURISDICTION), OR INFRINGEMENT OF ANY PATENT, COPYRIGHT OR OTHER INTELLECTUAL PROPERTY RIGHT.

UNLESS EXPRESSLY APPROVED IN WRITING BY AN AUTHORIZED ST REPRESENTATIVE, ST PRODUCTS ARE NOT RECOMMENDED, AUTHORIZED OR WARRANTED FOR USE IN MILITARY, AIR CRAFT, SPACE, LIFE SAVING, OR LIFE SUSTAINING APPLICATIONS, NOR IN PRODUCTS OR SYSTEMS WHERE FAILURE OR MALFUNCTION MAY RESULT IN PERSONAL INJURY, DEATH, OR SEVERE PROPERTY OR ENVIRONMENTAL DAMAGE. ST PRODUCTS WHICH ARE NOT SPECIFIED AS "AUTOMOTIVE GRADE" MAY ONLY BE USED IN AUTOMOTIVE APPLICATIONS AT USER'S OWN RISK.

Resale of ST products with provisions different from the statements and/or technical features set forth in this document shall immediately void any warranty granted by ST for the ST product or service described herein and shall not create or extend in any manner whatsoever, any liability of ST.

ST and the ST logo are trademarks or registered trademarks of ST in various countries.

Information in this document supersedes and replaces all information previously supplied.

The ST logo is a registered trademark of STMicroelectronics. All other names are the property of their respective owners.

© 2009 STMicroelectronics - All rights reserved

STMicroelectronics group of companies

Australia - Belgium - Brazil - Canada - China - Czech Republic - Finland - France - Germany - Hong Kong - India - Israel - Italy - Japan - Malaysia - Malta - Morocco - Philippines - Singapore - Spain - Sweden - Switzerland - United Kingdom - United States of America

www.st.com