

NC7WZ02

TinyLogic® UHS Dual 2-Input NOR Gate

General Description

The NC7WZ02 is a dual 2-Input NOR Gate from Fairchild's Ultra High Speed Series of TinyLogic®. The device is fabricated with advanced CMOS technology to achieve ultra high speed with high output drive while maintaining low static power dissipation over a very broad V_{CC} operating range. The device is specified to operate over the 1.65V to 5.5V V_{CC} range. The inputs and output are high impedance when V_{CC} is 0V. Inputs tolerate voltages up to 7V independent of V_{CC} operating voltage.

Features

- Space saving US8 surface mount package
- MicroPak™ Pb-Free leadless package
- Ultra High Speed: t_{PD} 2.4ns typ into 50pF at 5V V_{CC}
- High Output Drive: $\pm 24mA$ at 3V V_{CC}
- Broad V_{CC} Operating Range: 1.65V to 5.5V
- Matches the performance of LCX when operated at 3.3V V_{CC}
- Power down high impedance inputs/output
- Overvoltage tolerant inputs facilitate 5V to 3V translation
- Patented noise/EMI reduction circuitry implemented

Ordering Information

| Order Number | Package Number | Package Code Top Mark | Package Description | Supplied As |
|--------------|----------------|-----------------------|---|---------------------------|
| NC7WZ02K8X | MAB08A | WZ02 | 8-Lead US8, JEDEC MO-187, Variation CA 3.1mm Wide | 3k Units on Tape and Reel |
| NC7WZ02L8X | MAC08A | P5 | Pb-Free 8-Lead MicroPak, 1.6 mm Wide | 5k Units on Tape and Reel |

Pb-Free package per JEDEC J-STD-020B.

Logic Symbol

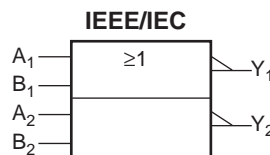

TinyLogic® is a registered trademark of Fairchild Semiconductor Corporation. MicroPak™ is a trademark of Fairchild Semiconductor Corporation.

Connection Diagrams

Pin Assignment for US8

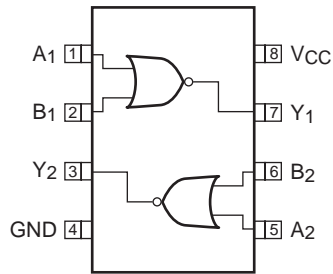

(Top View)

US8 Pin One Orientation Diagram

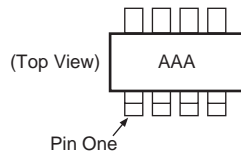

AAA represents Product Code Top Mark – see ordering code

Note: Orientation of Top Mark determines Pin One location. Read the top product code mark left to right, Pin One is the lower left pin (see diagram).

Pad Assignments for MicroPak

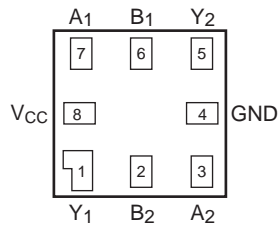

(Top Through View)

Pin Descriptions

| Pin Name | Description |
|------------|-------------|
| A_n, B_n | Inputs |
| Y_n | Outputs |

Function Table

$$Y = \overline{A + B}$$

| Inputs | | Outputs |
|--------|---|---------|
| A | B | Y |
| L | L | H |
| L | H | L |
| H | L | L |
| H | H | L |

H = HIGH Logic Level L = LOW Logic Level

Absolute Maximum Ratings

(The “Absolute Maximum Ratings” are those values beyond which the safety of the device cannot be guaranteed. The device should not be operated at these limits. The parametric values defined in the Electrical Characteristics tables are not guaranteed at the absolute maximum ratings. The “Recommended Operating Conditions” table will define the conditions for actual device operation.)

| Symbol | Parameter | Rating |
|------------------|---|-----------------|
| V_{CC} | Supply Voltage | -0.5V to +7V |
| V_{IN} | DC Input Voltage | -0.5V to +7V |
| V_{OUT} | DC Output Voltage | -0.5V to +7V |
| I_{IK} | DC Input Diode Current @ $V_{IN} \leq -0.5V$ | -50mA |
| I_{OK} | DC Output Diode Current @ $V_{OUT} \leq -0.5V$ | -50mA |
| I_{OUT} | DC Output Current | $\pm 50mA$ |
| I_{CC}/I_{GND} | DC V_{CC}/GND Current | $\pm 100mA$ |
| T_{STG} | Storage Temperature | -65°C to +150°C |
| T_J | Junction Temperature under Bias | 150°C |
| T_L | Junction Lead Temperature (Soldering, 10 seconds) | 260°C |
| P_D | Power Dissipation @ +85°C | 250mW |

Recommended Operating Conditions¹

| Symbol | Parameter | Rating |
|---------------|--|--|
| V_{CC} | Supply Voltage Operating | 1.65V to 5.5V |
| V_{CC} | Supply Voltage Data Retention | 1.5V to 5.5V |
| V_{IN} | Input Voltage | 0V to 5.5V |
| V_{OUT} | Output Voltage | 0V to V_{CC} |
| T_A | Operating Temperature | -40°C to +85°C |
| t_r, t_f | Input Rise and Fall Time V_{CC} @ 1.8V \pm 0.15V, 2.5V \pm 0.2V V_{CC} @ 3.3V \pm 0.3V V_{CC} @ 5.0V \pm 0.5V | 0ns/V to 20ns/V 0ns/V to 10ns/V 0ns/V to 5ns/V |
| θ_{JA} | Thermal Resistance | 250°C/W |

Notes:

1. Unused inputs must be held HIGH or LOW. They may not float.

DC Electrical Characteristics

| Symbol | Parameter | Conditions | V _{CC} (V) | T _A = | | | | | Units |
|------------------|---------------------------|---|---------------------|----------------------|------|----------------------|----------------------|----------------------|-------|
| | | | | 25°C | | | -40°C to +85°C | | |
| | | | | Min | Typ | Max | Min | Max | |
| V _{IH} | HIGH Level Input Voltage | | 1.65 to 1.95 | 0.75 V _{CC} | | | 0.75 V _{CC} | | V |
| | | | 2.3 to 5.5 | 0.7 V _{CC} | | | 0.7 V _{CC} | | |
| V _{IL} | LOW Level Input Voltage | | 1.65 to 1.95 | | | 0.25 V _{CC} | | 0.25 V _{CC} | V |
| | | | 2.3 to 5.5 | | | 0.3 V _{CC} | | 0.3 V _{CC} | |
| V _{OH} | High Level Output Voltage | V _{IN} = V _{IL} , I _{OH} = -100μA | 1.65 | 1.55 | 1.65 | | 1.55 | | V |
| | | | 2.3 | 2.2 | 2.3 | | 2.2 | | |
| | | | 3.0 | 2.9 | 3.0 | | 2.9 | | |
| | | | 4.5 | 4.4 | 4.5 | | 4.4 | | |
| | | I _{OH} = -4mA | 1.65 | 1.29 | 1.52 | | 1.29 | | |
| | | I _{OH} = -8mA | 2.3 | 1.9 | 2.15 | | 1.9 | | |
| | | I _{OH} = -16mA | 3.0 | 2.4 | 2.80 | | 2.4 | | |
| | | I _{OH} = -24mA | 3.0 | 2.3 | 2.68 | | 2.3 | | |
| V _{OL} | Low Level Output Voltage | V _{IN} = V _{IH} , I _{OL} = 100μA | 1.65 | | 0.0 | 0.1 | | 0.1 | V |
| | | | 2.3 | | 0.0 | 0.1 | | 0.1 | |
| | | | 3.0 | | 0.0 | 0.1 | | 0.1 | |
| | | | 4.5 | | 0.0 | 0.1 | | 0.1 | |
| | | I _{OL} = 4mA | 1.65 | | 0.08 | 0.24 | | 0.24 | |
| | | I _{OL} = 8mA | 2.3 | | 0.10 | 0.3 | | 0.3 | |
| | | I _{OL} = 16mA | 3.0 | | 0.15 | 0.4 | | 0.4 | |
| | | I _{OL} = 24mA | 3.0 | | 0.22 | 0.55 | | 0.55 | |
| I _{IN} | Input Leakage Current | V _{IN} = 5.5V, GND | 0 to 5.5 | | | ±0.1 | | ±1.0 | μA |
| | | | | | | | | | |
| I _{OFF} | Power OFF Leakage Current | V _{IN} or V _{OUT} = 5.5V | 0.0 | | | 1 | | 10 | μA |
| I _{CC} | Quiescent Supply Current | V _{IN} = 5.5V, GND | 1.65 to 5.5 | | | 1 | | 10 | μA |

AC Electrical Characteristics

| Symbol | Parameter | Conditions | V _{CC} (V) | T _A = | | | | | Units | Figure Number |
|-------------------------------------|-------------------------------|---|---------------------|------------------|------|-----|----------------|-----|-------|----------------------|
| | | | | +25°C | | | -40°C to +85°C | | | |
| | | | | Min | Typ | Max | Min | Max | | |
| t _{PLH} , t _{PHL} | Propagation Delay | R _L = 1MΩ, C _L = 15pF | 1.8 ± 0.15 | 2.0 | 5.4 | 9.8 | 2.0 | 10 | ns | Figure 1 Figure 3 |
| | | | 2.5 ± 0.2 | 1.2 | 3.3 | 5.4 | 1.2 | 5.8 | | |
| | | | 3.3 ± 0.3 | 0.8 | 2.5 | 3.8 | 0.8 | 4.1 | | |
| | | | 5.0 ± 0.5 | 0.5 | 2.0 | 3.0 | 0.5 | 3.3 | | |
| t _{PLH} , t _{PHL} | Propagation Delay | R _L = 500Ω, C _L = 50pF | 3.3 ± 0.3 | 1.2 | 3.1 | 4.6 | 1.2 | 5.0 | ns | Figure 1 Figure 3 |
| | | | 5.0 ± 0.5 | 0.8 | 2.4 | 3.7 | 0.8 | 4.0 | | |
| C _{IN} | Input Capacitance | | 0 | | 2.5 | | | | pF | |
| C _{PD} | Power Dissipation Capacitance | Note 2 | 3.3 | | 13.5 | | | | pF | Figure 2 |
| | | | 5.0 | | 17.5 | | | | | |

Notes:

2. C_{PD} is defined as the value of the internal equivalent capacitance which is derived from dynamic operating current consumption (I_{CCD}) at no output loading and operating at 50% duty cycle. (See Figure 2.) C_{PD} is related to I_{CCD} dynamic operating current by the expression:

$$C_{PD} = I_{CCD} / (V_{CC}) (F).$$

AC Loading and Waveforms

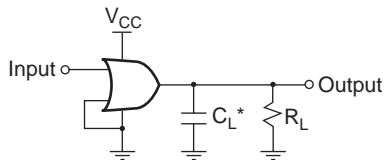

*C_L includes load and stray capacitance.
Input PRR = 1.0MHz; t_w = 500ns

Figure 1. AC Test Circuit

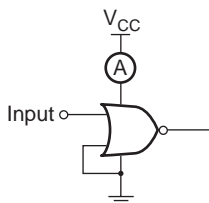

Input = AC Waveform; t_r, t_f = 1.8ns;
PRR = 10MHz; Duty Cycle = 50%

Figure 2. I_{CCD} Test Circuit

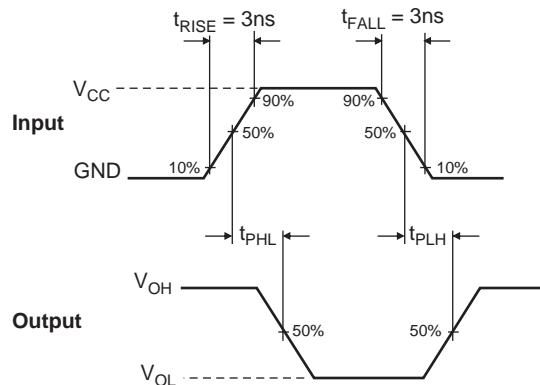

Figure 3. AC Waveforms

Tape and Reel Specification

Tape Format for MircoPak

| Package Designator | Tape Section | Number Cavities | Cavity Status | Cover Tape Status |
|--------------------|--------------------|-----------------|---------------|-------------------|
| L8X | Leader (Start End) | 125 (typ) | Empty | Sealed |
| | Carrier | 3000 | Filled | Sealed |
| | Trailer (Hub End) | 75 (typ) | Empty | Sealed |

Tape Dimension inches (millimeters)

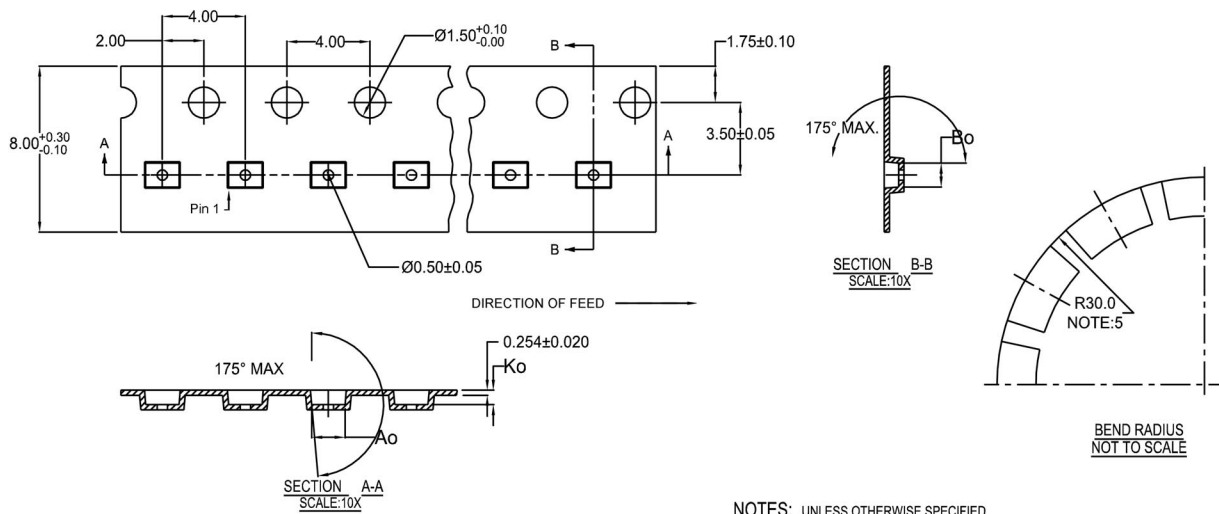

| | | | | |
|----|--------|-------------|-------------|-------------|
| 10 | 300056 | 2.30 ± 0.05 | 1.78 ± 0.05 | 0.68 ± 0.05 |
| 8 | 300038 | 1.78 ± 0.05 | 1.78 ± 0.05 | 0.68 ± 0.05 |
| 6 | 300033 | 1.60 ± 0.05 | 1.15 ± 0.05 | 0.70 ± 0.05 |

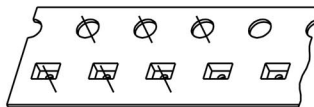

SCALE: 6X

NOTES: UNLESS OTHERWISE SPECIFIED

- ACCUMULATED 50 SPROCKETS, SPROCKET HOLE PITCH IS 200.00 ± 0.30MM
- NO INDICATED CORNER RADIUS IS 0.127MM
- CAMBER NOT TO EXCEED 1MM IN 100MM
- SMALLEST ALLOWABLE BENDING RADIUS
- POCKET POSITION RELATIVE TO SPROCKET HOLE MEASURED AS TRUE POSITION OF POCKET, NOT POCKET HOLE

Reel Dimension for MircoPak inches (millimeters)

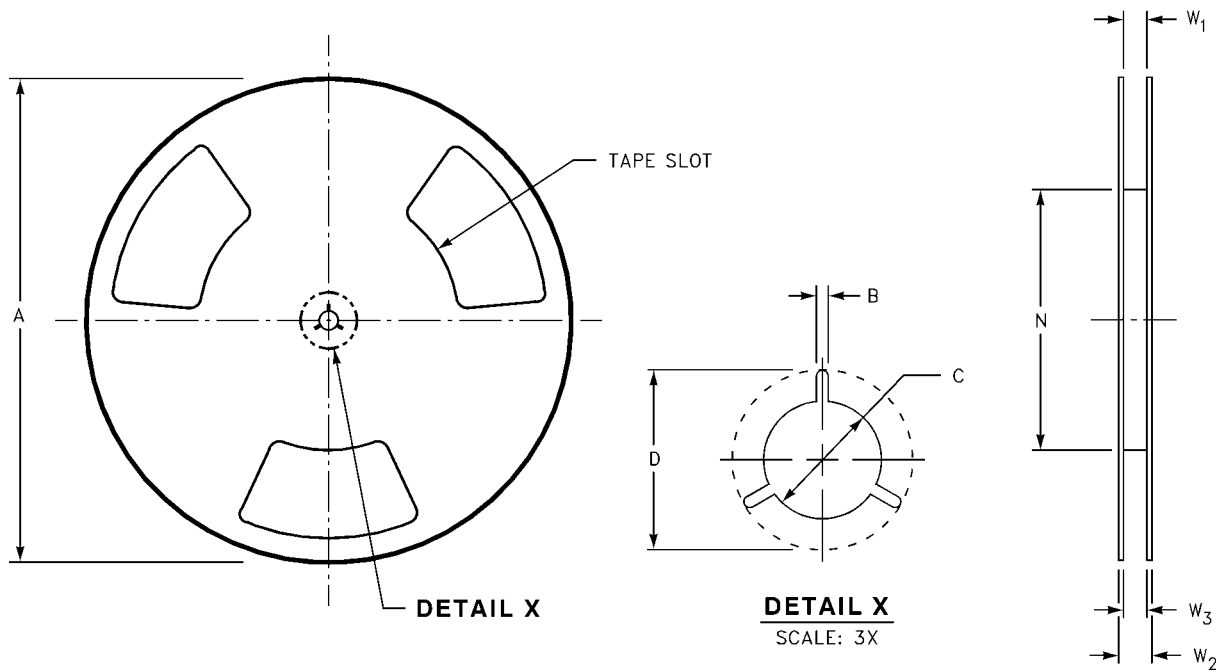

| Tape Size | A | B | C | D | N | W1 | W2 | W3 |
|-----------|----------------|-----------------|------------------|------------------|------------------|---|------------------|--|
| 8 mm | 7.0 (177.8) | 0.059 (1.50) | 0.512 (13.00) | 0.795 (20.20) | 2.165 (55.00) | 0.331 + 0.059/-0.000 (8.40 + 1.50/-0.00) | 0.567 (14.40) | W1 + 0.078/-0.039 (W1 + 2.00/-1.00) |

Tape Format for US8

| Package Designator | Tape Section | Number Cavities | Cavity Status | Cover Tape Status |
|--------------------|--------------------|-----------------|---------------|-------------------|
| K8X | Leader (Start End) | 125 (typ) | Empty | Sealed |
| | Carrier | 3000 | Filled | Sealed |
| | Trailer (Hub End) | 75 (typ) | Empty | Sealed |

Tape Dimension inches (millimeters)

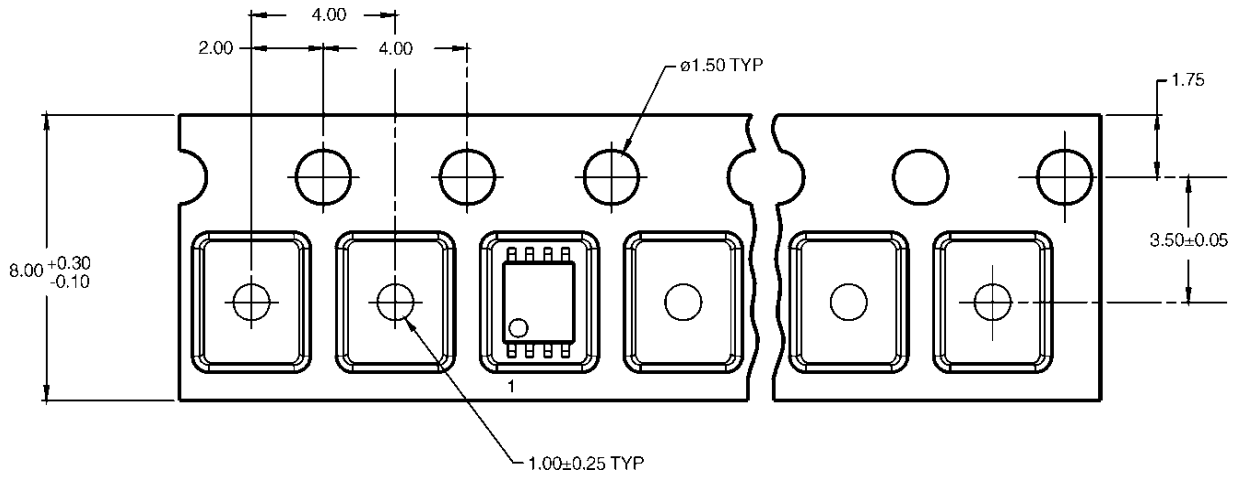

Physical Dimensions inches (millimeters) unless otherwise noted

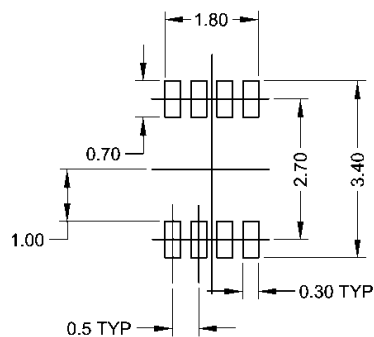
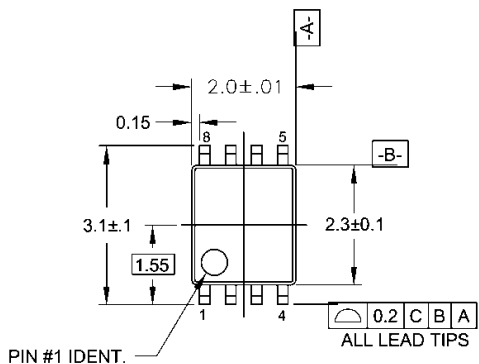

LAND PATTERN RECOMMENDATION

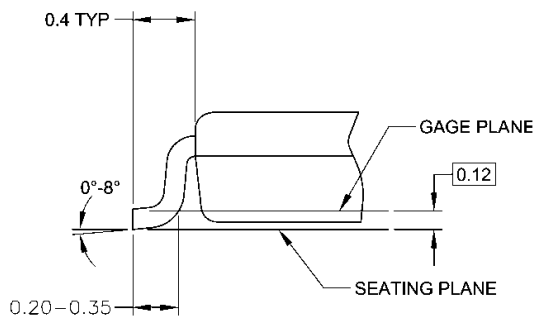
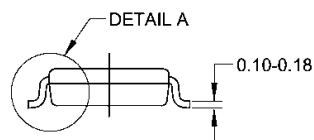
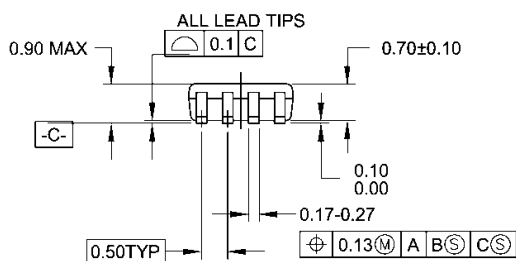

DETAIL A

NOTES:

- A. CONFORMS TO JEDEC REGISTRATION MO-187
- B. DIMENSIONS ARE IN MILLIMETERS.
- C. DIMENSIONS ARE EXCLUSIVE OF BURRS, MOLD FLASH, AND TIE BAR EXTRUSIONS.
- D. DIMENSIONS AND TOLERANCES PER ANSI Y14.5M, 1982.

MAB08AREVC

**8-Lead US8, JEDEC MO-187, Variation CA 3.1mm Wide
Package Number MAB08A**

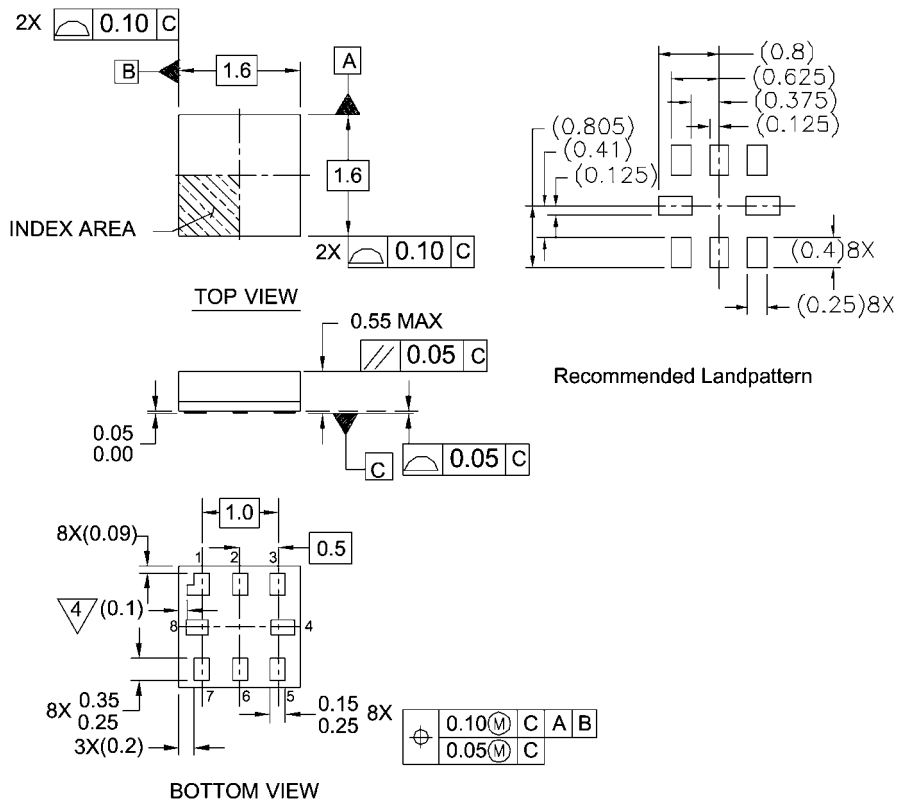

Notes:

1. PACKAGE CONFORMS TO JEDEC MO-255 VARIATION UAAD
2. DIMENSIONS ARE IN MILLIMETERS
3. DRAWING CONFORMS TO ASME Y.14M-1994
4. PIN 1 FLAG, END OF PACKAGE OFFSET.

MAC08AREVC

**Pb-Free 8-Lead MicroPak, 1.6 mm Wide
Package Number MAC08A**

TRADEMARKS

The following are registered and unregistered trademarks Fairchild Semiconductor owns or is authorized to use and is not intended to be an exhaustive list of all such trademarks.

| | | | | |
|--------------------------------------|---------------------|---------------|---------------------|-----------------|
| ACEx™ | FAST® | ISOPLANAR™ | PowerSaver™ | SuperSOT™-6 |
| ActiveArray™ | FASTr™ | LittleFET™ | PowerTrench® | SuperSOT™-8 |
| Bottomless™ | FPS™ | MICROCOUPLER™ | QFET® | SyncFET™ |
| Build it Now™ | FRFET™ | MicroFET™ | QS™ | TinyLogic® |
| CoolFET™ | GlobalOptoisolator™ | MicroPak™ | QT Optoelectronics™ | TINYOPTO™ |
| CROSSVOLT™ | GTO™ | MICROWIRE™ | Quiet Series™ | TruTranslation™ |
| DOMET™ | HiSeC™ | MSX™ | RapidConfigure™ | UHC™ |
| EcoSPARK™ | I ² C™ | MSXPro™ | RapidConnect™ | UltraFET® |
| E ² CMOS™ | i-Lo™ | OCX™ | μSerDes™ | UniFET™ |
| EnSigna™ | ImpliedDisconnect™ | OCXPro™ | ScalarPump™ | VCX™ |
| FACT™ | IntelliMAX™ | OPTOLOGIC® | SILENT SWITCHER® | Wire™ |
| FACT Quiet Series™ | | OPTOPLANAR™ | SMART START™ | |
| Across the board. Around the world.™ | | PACMAN™ | SPM™ | |
| The Power Franchise® | | POP™ | Stealth™ | |
| Programmable Active Droop™ | | Power247™ | SuperFET™ | |
| | | PowerEdge™ | SuperSOT™-3 | |

DISCLAIMER

FAIRCHILD SEMICONDUCTOR RESERVES THE RIGHT TO MAKE CHANGES WITHOUT FURTHER NOTICE TO ANY PRODUCTS HEREIN TO IMPROVE RELIABILITY, FUNCTION OR DESIGN. FAIRCHILD DOES NOT ASSUME ANY LIABILITY ARISING OUT OF THE APPLICATION OR USE OF ANY PRODUCT OR CIRCUIT DESCRIBED HEREIN; NEITHER DOES IT CONVEY ANY LICENSE UNDER ITS PATENT RIGHTS, NOR THE RIGHTS OF OTHERS.

LIFE SUPPORT POLICY

FAIRCHILD'S PRODUCTS ARE NOT AUTHORIZED FOR USE AS CRITICAL COMPONENTS IN LIFE SUPPORT DEVICES OR SYSTEMS WITHOUT THE EXPRESS WRITTEN APPROVAL OF FAIRCHILD SEMICONDUCTOR CORPORATION. As used herein:

1. Life support devices or systems are devices or systems which, (a) are intended for surgical implant into the body, or (b) support or sustain life, or (c) whose failure to perform when properly used in accordance with instructions for use provided in the labeling, can be reasonably expected to result in significant injury to the user.
2. A critical component is any component of a life support device or system whose failure to perform can be reasonably expected to cause the failure of the life support device or system, or to affect its safety or effectiveness.

PRODUCT STATUS DEFINITIONS

Definition of Terms

| Datasheet Identification | Product Status | Definition |
|--------------------------|------------------------|---|
| Advance Information | Formative or In Design | This datasheet contains the design specifications for product development. Specifications may change in any manner without notice. |
| Preliminary | First Production | This datasheet contains preliminary data, and supplementary data will be published at a later date. Fairchild Semiconductor reserves the right to make changes at any time without notice in order to improve design. |
| No Identification Needed | Full Production | This datasheet contains final specifications. Fairchild Semiconductor reserves the right to make changes at any time without notice in order to improve design. |
| Obsolete | Not In Production | This datasheet contains specifications on a product that has been discontinued by Fairchild semiconductor. The datasheet is printed for reference information only. |

Rev. 117