

LMV1031-20

Amplifier for Internal 3-Wire Analog Microphones and External Preamplifier

General Description

The LMV1031 audio amplifier is an ideal replacement for the JFET preamplifier that is currently used in the electret microphones. The LMV1031 is optimized for applications that require extended battery life, such as Bluetooth communication links. The supply current for the LMV1031 is only 72 μ A. This is a dramatic reduction from that required for a JFET equipped microphone. The LMV1031, with its separate output and supply pins, offers a higher PSRR and eliminates the need for additional external components.

The LMV1031 is guaranteed to operate from 2V to 5V supply voltage over the full temperature range, has a fixed voltage gain of 20 dB and enhanced SNR performance. The LMV1031 is optimized for an output biasing of 1.09V.

The LMV1031 has less than 200 Ω of output impedance over the full audio bandwidth. The gain response of the LMV1031 is flat within the audio band and is stable over the temperature range.

The LMV1031 is available in a large dome 4-bump ultra thin micro SMD package that can easily fit on the PCB inside the miniature microphone metal can (package). This package is designed for microphone PCBs requiring 1 kg adhesion criteria.

Features

(Typical LMV1031-20, 2V Supply; Unless Otherwise Noted)

- Signal to noise ratio 62 dB
- Output voltage noise (A-weighted) -86 dBV
- Low supply current 72 μ A
- Supply voltage 2V to 5V
- Input impedance >100 M Ω
- Max input signal 108 mV_{PP}
- Output voltage 1.09V
- Temperature range -40°C to 85°C
- Large Dome 4-Bump micro SMD package with improved adhesion technology.

Applications

- Mobile communications - Bluetooth
- Accessory microphone products
- Cellular phones
- PDAs

Block Diagram

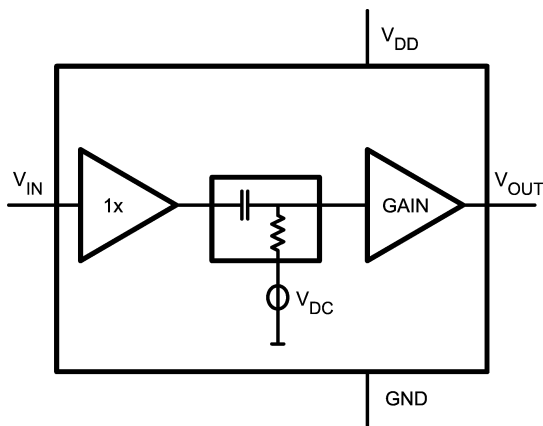

Electret Microphone

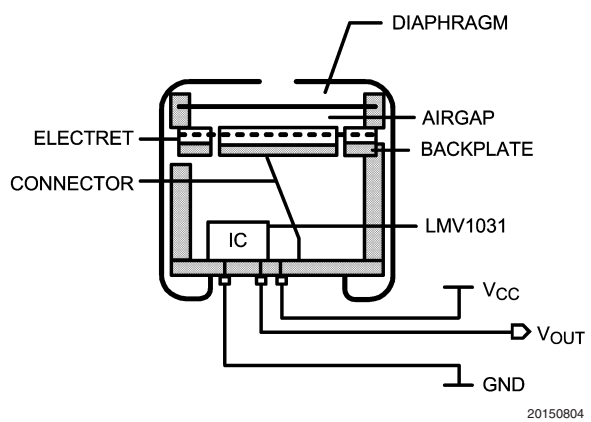

Absolute Maximum Ratings (Note 1)

If Military/Aerospace specified devices are required, please contact the National Semiconductor Sales Office/Distributors for availability and specifications.

ESD Tolerance (Note 2)	
Human Body Model	2500V
Machine Model	250V
Supply Voltage	
$V_{DD} - GND$	5.5V

Storage Temperature Range	-65°C to 150°C
Junction Temperature (Note 6)	150°C max
Mounting Temperature	
Infrared or Convection (20 sec.)	235°C

Operating Ratings (Note 1)

Supply Voltage	2V to 5V
Temperature Range	-40°C to +85°C

2V and 5V Electrical Characteristics (Note 3)

Unless otherwise specified, all limits are guaranteed for $T_J = 25^\circ\text{C}$ and $V_{DD} = 2\text{V}$ and 5V . **Boldface** limits apply at the temperature extremes.

Symbol	Parameter	Conditions	Min (Note 4)	Typ (Note 5)	Max (Note 4)	Units
I_{DD}	Supply Current	$V_{IN} = GND$		72	90 100	μA
SNR	Signal to Noise Ratio	$f = 1\text{ kHz}, V_{IN} = 18\text{ mV}_{PP}$		62		dB
THD	Total Harmonic Distortion	$f = 1\text{ kHz}, V_{IN} = 18\text{ mV}_{PP}$		0.18		%
e_n	Output Noise	A-Weighted		-86		dBV
A_V	Gain	$f = 1\text{ kHz}, V_{IN} = 18\text{ mV}_{PP}$	19.18 19.00	20.1	20.90 21.00	dB
f_{LOW}	Lower -3 dB Roll Off Frequency	$R_{SOURCE} = 50\Omega, V_{IN} = 18\text{ mV}_{PP}$		72		Hz
f_{HIGH}	Upper -3 dB Roll Off Frequency	$R_{SOURCE} = 50\Omega, V_{IN} = 18\text{ mV}_{PP}$		52		kHz
V_{IN}	Max Input Signal	$f = 1\text{ kHz}$ and $THD+N < 1\%$		108		mV_{PP}
Z_{IN}	Input Impedance			>100		$\text{M}\Omega$
C_{IN}	Input Capacitance			2		pF
V_{OUT}	Output Voltage	$V_{IN} = GND$	890 875	1090	1310 1325	mV
R_O	Output Impedance	$f = 1\text{ kHz}$		<200		Ω
PSRR	Power Supply Rejection Ratio	$2\text{V} < V_{DD} < 5\text{V}$		56		dB

Note 1: Absolute Maximum Ratings indicate limits beyond which damage to the device may occur. Operating Ratings indicate conditions for which the device is intended to be functional, but specific performance is not guaranteed. For guaranteed specifications and the test conditions, see the Electrical Characteristics.

Note 2: The human body model (HBM) is 1.5 k Ω in series with 100 pF. The machine model is 0 Ω in series with 200 pF.

Note 3: Electrical table values apply only for factory testing conditions at the temperature indicated. Factory testing conditions result in very limited self-heating of the device such that $T_J = T_A$. No guarantee of parametric performance is indicated in the electrical tables under conditions of internal self-heating where $T_J > T_A$.

Note 4: All limits are guaranteed by design or statistical analysis.

Note 5: Typical values represent the most likely parametric norm at the time of characterization.

Note 6: The maximum power dissipation is a function of $T_{J(MAX)}, \theta_{JA}$ and T_A . The maximum allowable power dissipation at any ambient temperature is $P_D = (T_{J(MAX)} - T_A)/\theta_{JA}$. All numbers apply for packages soldered directly onto a PC board.

Connection Diagram

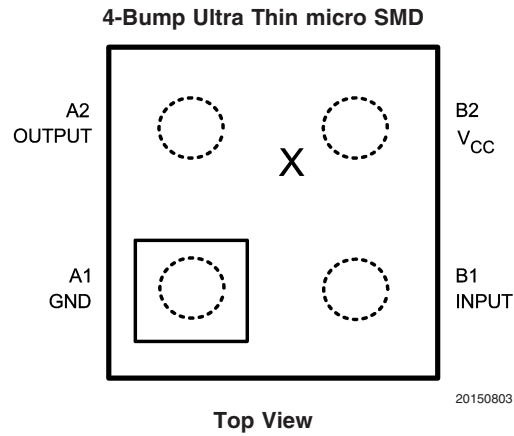

Note: - Pin numbers are referenced to package marking text orientation.

- The actual physical placement of the package marking will vary slightly from part to part. The package will designate the date code and will vary considerably. Package marking does not correlate to device type in any way.

Ordering Information

Package	Part Number	Package Marking	Transport Media	NSC Drawing
4-Bump Ultra Thin micro SMD lead free	LMV1031UR-20	Date Code	250 Units Tape and Reel	URA04JJA
	LMV1031URX-20		3k Units Tape and Reel	

Typical Performance Characteristics Unless otherwise specified, $V_S = 2V$, single supply, $T_A = 25^\circ C$

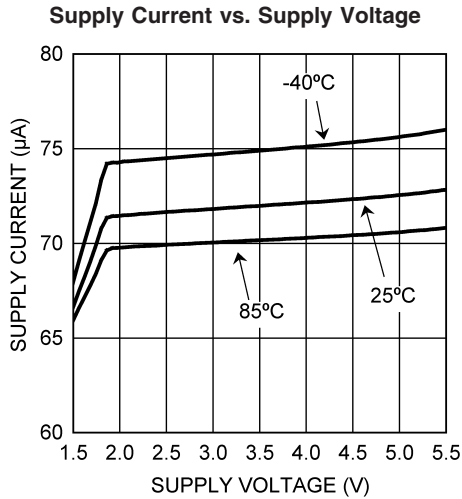

20150815

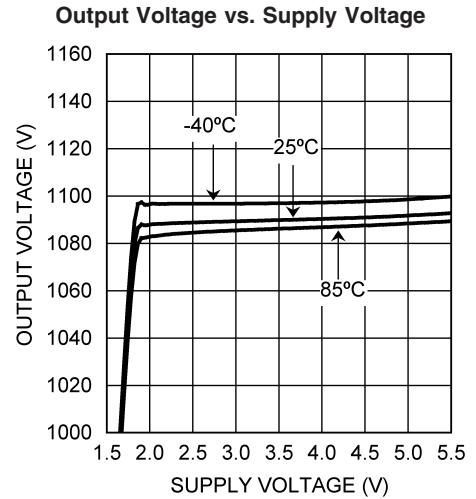

20150823

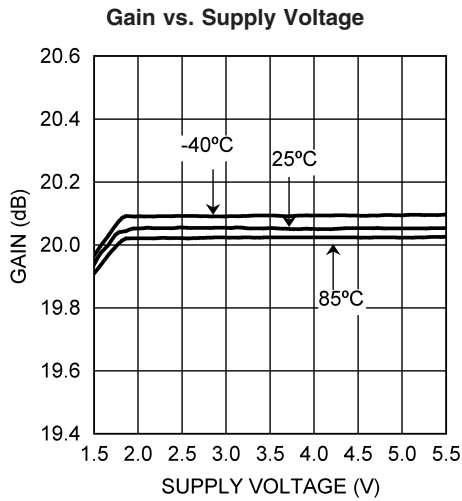

20150824

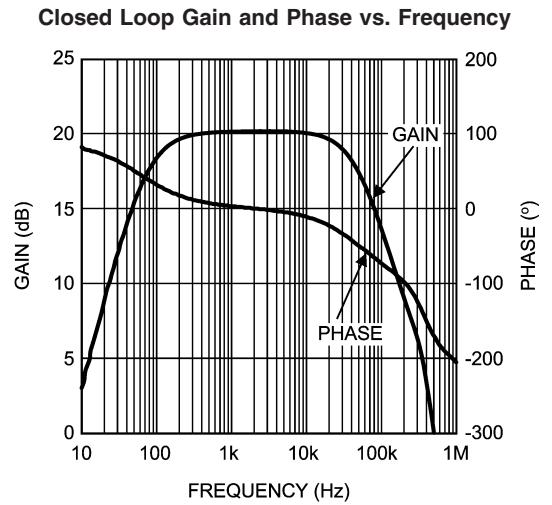

20150816

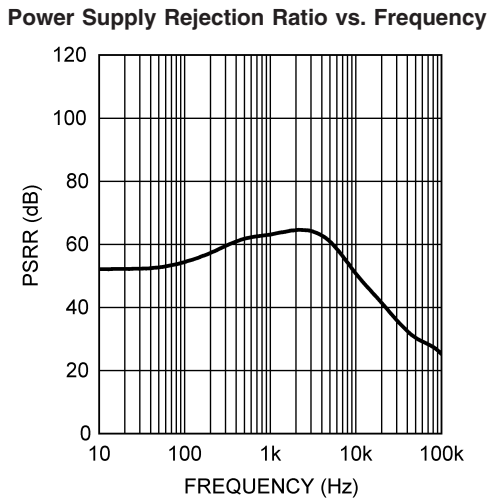

20150817

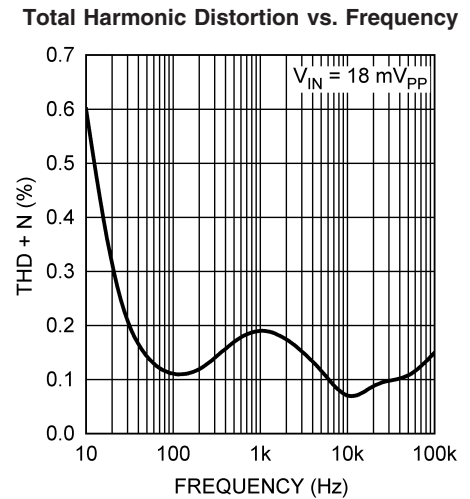

20150818

Typical Performance Characteristics

Unless otherwise specified, $V_S = 2V$, single supply, $T_A = 25^\circ C$ (Continued)

Total Harmonic Distortion vs. Input Voltage

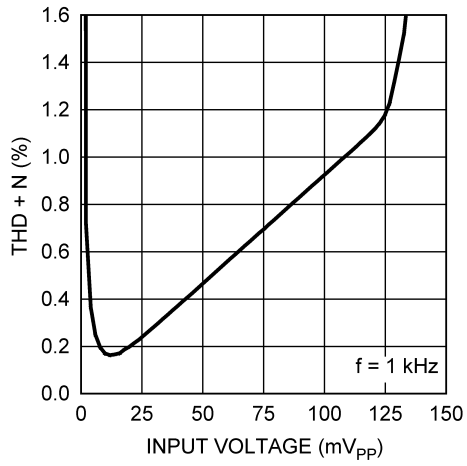

Output Voltage Noise vs. Frequency

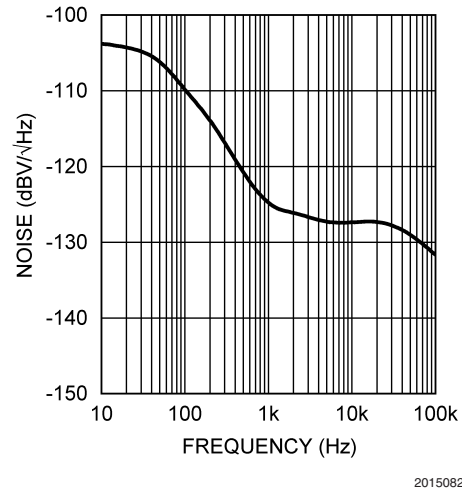

Application Section

LOW CURRENT

The LMV1031 has a low supply current which allows for a longer battery life. The low supply current of 72 μA makes this amplifier optimal for microphone applications which need to be always on.

BUILT-IN GAIN

The LMV1031 is offered in the space saving small micro SMD package which fits perfectly into the metal can of a microphone. This allows the LMV1031 to be placed on the PCB inside the microphone.

The bottom side of the PCB has the pins that connect the supply voltage to the amplifier and make the output available. The input of the amplifier is connected to the microphone via the PCB.

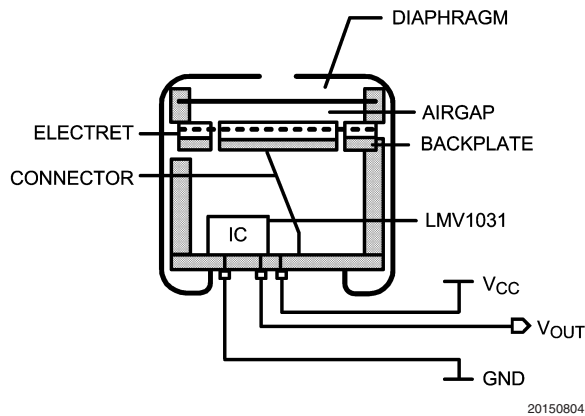
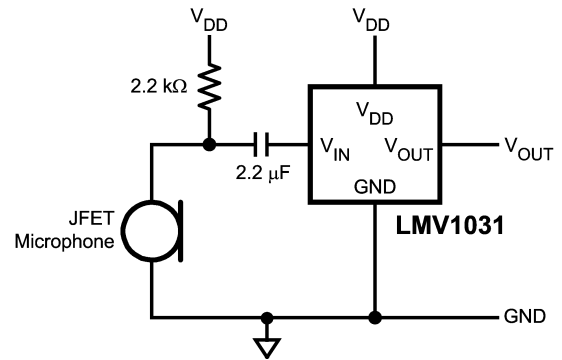

FIGURE 1. Built-in Gain

EXTERNAL PREAMPLIFIER APPLICATION

The LMV1031 can also be used outside of an ECM as a space saving external preamplifier. In this application, the LMV1031 follows a phantom biased JFET microphone in the circuit. This is shown in *Figure 2*. The input of the LMV1031 is connected to the microphone via a 2.2 μF capacitor. The advantages of this circuit over one with only a JFET microphone are the additional gain and the high pass filter supplied by the LMV1031. The high pass filter makes the output signal more robust and less sensitive to low frequency disturbances. In this configuration the LMV1031 should be placed as close as possible to the microphone.



20150802

FIGURE 2. LMV1031 as external preamplifier

A-WEIGHTED FILTER

The human ear has a frequency range from 20 Hz to about 20 kHz. Within this range the sensitivity of the human ear is not equal for each frequency. To approach the hearing response weighting filters are introduced. One of those filters is the A-weighted filter.

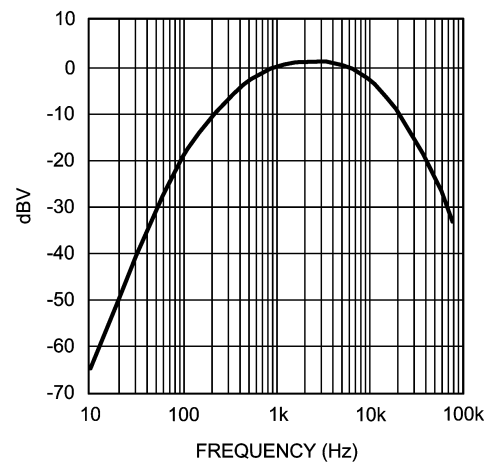

20150811

FIGURE 3. A-Weighted Filter

The A-weighted filter is commonly used in signal-to-noise ratio measurements, where sound is compared to device noise. It improves the correlation of the measured data to the signal-to-noise ratio perceived by the human ear.

OUTPUT CURRENT

The LMV1031 is designed for driving high ohmic loads with several milli amperes of output current. *Figure 4* shows the gain performance of the LMV1031 versus the sinking and sourcing current. The gain remains constant within the shown output current range. This sets the operating range of the LMV1031 with respect to the output current.

Application Section (Continued)

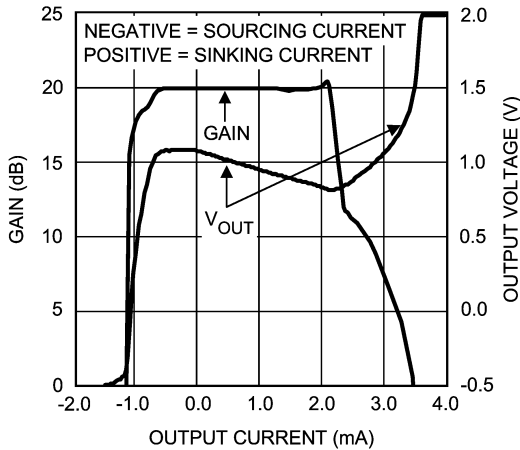

FIGURE 4. Performance vs. Output Current

MEASURING NOISE AND SNR

The overall noise of the LMV1031 is measured within the frequency band from 10 Hz to 22 kHz using an A-weighted filter. The input of the LMV1031 is connected to ground with a 5 pF capacitor.

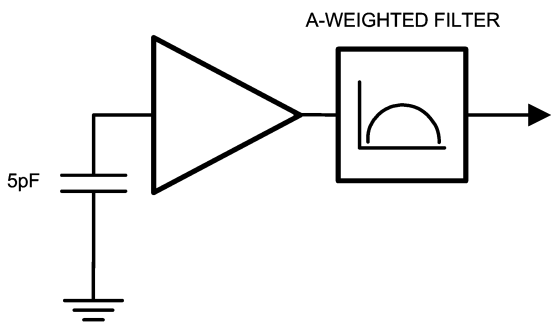

FIGURE 5. Noise Measurement Setup

The signal-to-noise ratio (SNR) is measured with a 1 kHz input signal of 18 mV_{PP} using an A-weighted filter. This represents a sound pressure level of 94 dB with a standard ECM sensitivity. No input capacitor is connected.

SOUND PRESSURE LEVEL

The volume of sound applied to a microphone is commonly stated as the pressure level with respect to the threshold of hearing of the human ear. This sound pressure level (SPL) in decibels is defined by:

$$\text{Sound pressure level (dB)} = 20 \log P_m/P_o$$

Where,

P_m is the measured sound pressure

P_o is the threshold of hearing (20 μ Pa)

In order to be able to calculate the resulting output voltage of the microphone for a given SPL, the sound pressure in dB SPL needs to be converted to the absolute sound pressure in dBPa. This is the sound pressure level in decibels which is referred to 1 Pascal (Pa).

The conversion is given by:

$$\text{dBPa} = \text{dB SPL} + 20 \cdot \log 20 \mu\text{Pa}$$

$$\text{dBPa} = \text{dB SPL} - 94 \text{ dB}$$

Translation from absolute sound pressure level to a voltage is specified by the sensitivity of the microphone. A conventional microphone has a sensitivity of -44 dBV/Pa.

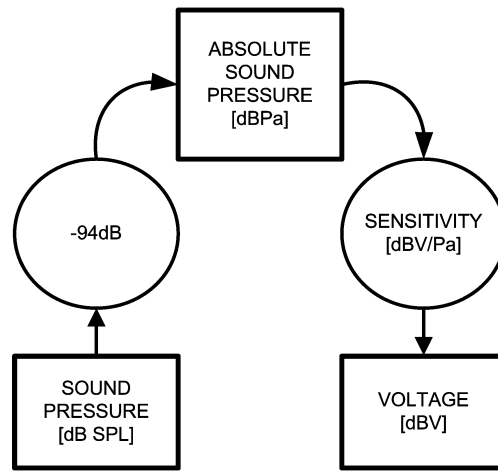

FIGURE 6. dB SPL to dBV Conversion

Example: Busy traffic is 70 dB

$$V_{OUT} = 70 - 94 - 44 = -68 \text{ dBV}$$

This is equivalent to 1.13 mV_{PP}

Since the LMV1031-20 has a gain of 10 times (20 dB) over the JFET, the output voltage of the microphone is 11.3 mV_{PP}. By replacing the JFET with the LMV1031-20, the sensitivity of the microphone is -24 dBV/Pa (-44 + 20).

LOW FREQUENCY CUT-OFF FILTER

The LMV1031 has a low cut-off filter on the output of the microphone, to reduce low frequency noises, such as wind and vibration. This also helps to reduce the proximity effect in directional microphones. This effect occurs when the sound source is very close to the microphone. The lower frequencies are amplified which gives a bass sound. This amplification can cause an overload, which results in a distortion of the signal.

Application Section (Continued)

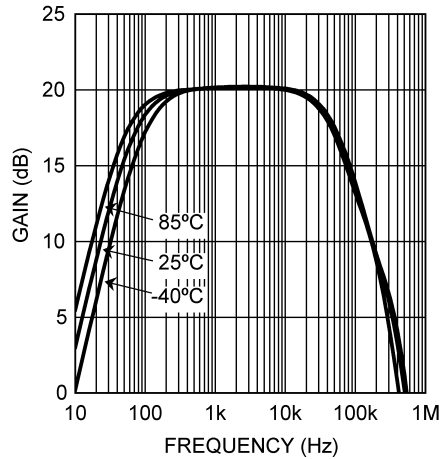

20150821

FIGURE 7. Gain vs. Frequency

The LMV1031 is optimized to be used in audio band applications. As shown in *Figure 7*, the LMV1031 provides a flat gain response within the audio band and offers excellent temperature stability.

ADVANTAGE OF THREE PINS

When implemented in an Electret Condenser Microphone (ECM) the LMV1031 adds the advantages of a three pin configuration. The third pin provides a low supply current, higher PSRR, and eliminates the need for additional external components.

It is well known that cell phone microphones are sensitive to noise pick-up. A conventional JFET circuit is sensitive to noise pick-up because of its high output impedance, which is usually around 2.2 k Ω . The LMV1031 is less sensitive to noise pick-up because it provides separate output and supply pins. Using separate pins greatly reduces the output impedance.

Physical Dimensions inches (millimeters)

unless otherwise noted

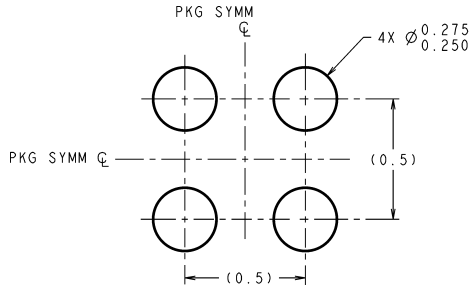

DIMENSIONS ARE IN MILLIMETERS
DIMENSIONS IN () FOR REFERENCE ONLY

LAND PATTERN RECOMMENDATION

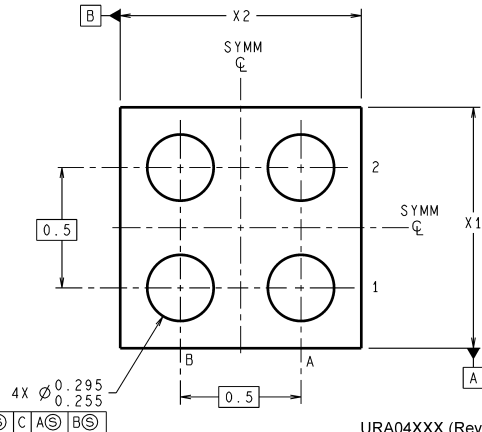
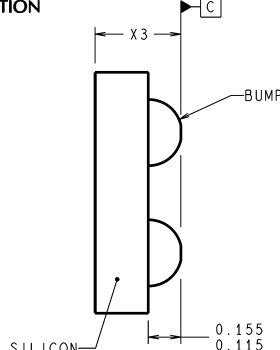
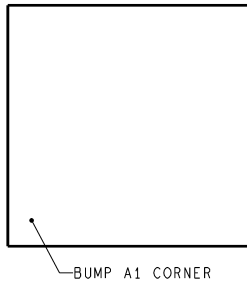

URA04XXX (Rev D)

NOTE: UNLESS OTHERWISE SPECIFIED.

- FOR SOLDER BUMP COMPOSITION, SEE "SOLDER INFORMATION" IN THE PACKAGING SECTION OF THE NATIONAL SEMICONDUCTOR WEB PAGE (www.national.com).
- RECOMMEND NON-SOLDER MASK DEFINED LANDING PAD.
- PIN A1 IS ESTABLISHED BY LOWER LEFT CORNER WITH RESPECT TO TEXT ORIENTATION.
- XXX IN DRAWING NUMBER REPRESENTS PACKAGE SIZE VARIATION WHERE X1 IS PACKAGE WIDTH, X2 IS PACKAGE LENGTH AND X3 IS PACKAGE HEIGHT.
- NO JEDEC REGISTRATION AS OF NOVEMBER 2004.

4-Bump Ultra Thin micro SMD with Large Dome Bump Technology NS Package Number URA04JJA

X1 = 1.179 mm X2 = 1.179 mm X3 = 0.35 mm

National does not assume any responsibility for use of any circuitry described, no circuit patent licenses are implied and National reserves the right at any time without notice to change said circuitry and specifications.

For the most current product information visit us at www.national.com.

LIFE SUPPORT POLICY

NATIONAL'S PRODUCTS ARE NOT AUTHORIZED FOR USE AS CRITICAL COMPONENTS IN LIFE SUPPORT DEVICES OR SYSTEMS WITHOUT THE EXPRESS WRITTEN APPROVAL OF THE PRESIDENT AND GENERAL COUNSEL OF NATIONAL SEMICONDUCTOR CORPORATION. As used herein:

- Life support devices or systems are devices or systems which, (a) are intended for surgical implant into the body, or (b) support or sustain life, and whose failure to perform when properly used in accordance with instructions for use provided in the labeling, can be reasonably expected to result in a significant injury to the user.
- A critical component is any component of a life support device or system whose failure to perform can be reasonably expected to cause the failure of the life support device or system, or to affect its safety or effectiveness.

BANNED SUBSTANCE COMPLIANCE

National Semiconductor manufactures products and uses packing materials that meet the provisions of the Customer Products Stewardship Specification (CSP-9-111C2) and the Banned Substances and Materials of Interest Specification (CSP-9-111S2) and contain no "Banned Substances" as defined in CSP-9-111S2.

Leadfree products are RoHS compliant.



National Semiconductor
Americas Customer
Support Center
Email: new.feedback@nsc.com
Tel: 1-800-272-9959

National Semiconductor
Europe Customer Support Center
Fax: +49 (0) 180-530 85 86
Email: europe.support@nsc.com
Deutsch Tel: +49 (0) 69 9508 6208
English Tel: +44 (0) 870 24 0 2171
Français Tel: +33 (0) 1 41 91 8790

National Semiconductor
Asia Pacific Customer
Support Center
Email: ap.support@nsc.com

National Semiconductor
Japan Customer Support Center
Fax: 81-3-5639-7507
Email: jpn.feedback@nsc.com

LMV1031-20 Amplifiers for Internal 3-Wire Analog Microphones and External Preamplifier

www.national.com

Tel: 81-3-5639-7560