

74LVC2G14

Dual inverting Schmitt trigger with 5 V tolerant input

Rev. 5 — 29 October 2010

Product data sheet

1. General description

The 74LVC2G14 provides two inverting buffers with Schmitt-trigger action.

The inputs can be driven from either 3.3 V or 5 V devices. This feature allows the use of this device in a mixed 3.3 V and 5 V environment. Schmitt-trigger action at the inputs makes the circuit tolerant of slower input rise and fall time. This device is fully specified for partial power-down applications using I_{OFF} . The I_{OFF} circuitry disables the output, preventing the damaging backflow current through the device when it is powered down.

2. Features and benefits

- Wide supply voltage range from 1.65 V to 5.5 V
- 5 V tolerant inputs for interfacing with 5 V logic
- High noise immunity
- Complies with JEDEC standard:
 - ◆ JESD8-7 (1.65 V to 1.95 V)
 - ◆ JESD8-5 (2.3 V to 2.7 V)
 - ◆ JESD8B/JESD36 (2.7 V to 3.6 V)
- ESD protection:
 - ◆ HBM JESD22-A114F exceeds 2000 V
 - ◆ MM JESD22-A115-A exceeds 200 V
- ± 24 mA output drive ($V_{CC} = 3.0$ V)
- CMOS low power consumption
- Latch-up performance exceeds 250 mA
- Direct interface with TTL levels
- Unlimited rise and fall times
- Input accepts voltages up to 5 V
- Multiple package options
- Specified from -40 °C to $+85$ °C and -40 °C to $+125$ °C.

3. Applications

- Wave and pulse shaper
- Astable multivibrator
- Monostable multivibrator



4. Ordering information

Table 1. Ordering information

| Type number | Package | | | Version |
|-------------|-------------------|-------|---|---------|
| | Temperature range | Name | Description | |
| 74LVC2G14GW | -40 °C to +125 °C | SC-88 | plastic surface-mounted package; 6 leads | SOT363 |
| 74LVC2G14GV | -40 °C to +125 °C | TSOP6 | plastic surface-mounted package (TSOP6); 6 leads | SOT457 |
| 74LVC2G14GM | -40 °C to +125 °C | XSON6 | plastic extremely thin small outline package; no leads; 6 terminals; body 1 × 1.45 × 0.5 mm | SOT886 |
| 74LVC2G14GF | -40 °C to +125 °C | XSON6 | plastic extremely thin small outline package; no leads; 6 terminals; body 1 × 1 × 0.5 mm | SOT891 |
| 74LVC2G14GN | -40 °C to +125 °C | XSON6 | extremely thin small outline package; no leads; 6 terminals; body 0.9 × 1.0 × 0.35 mm | SOT1115 |
| 74LVC2G14GS | -40 °C to +125 °C | XSON6 | extremely thin small outline package; no leads; 6 terminals; body 1.0 × 1.0 × 0.35 mm | SOT1202 |

5. Marking

Table 2. Marking codes

| Type number | Marking code ^[1] |
|-------------|-----------------------------|
| 74LVC2G14GW | VK |
| 74LVC2G14GV | V14 |
| 74LVC2G14GM | VK |
| 74LVC2G14GF | VK |
| 74LVC2G14GN | VK |
| 74LVC2G14GS | VK |

[1] The pin 1 indicator is located on the lower left corner of the device, below the marking code.

6. Functional diagram

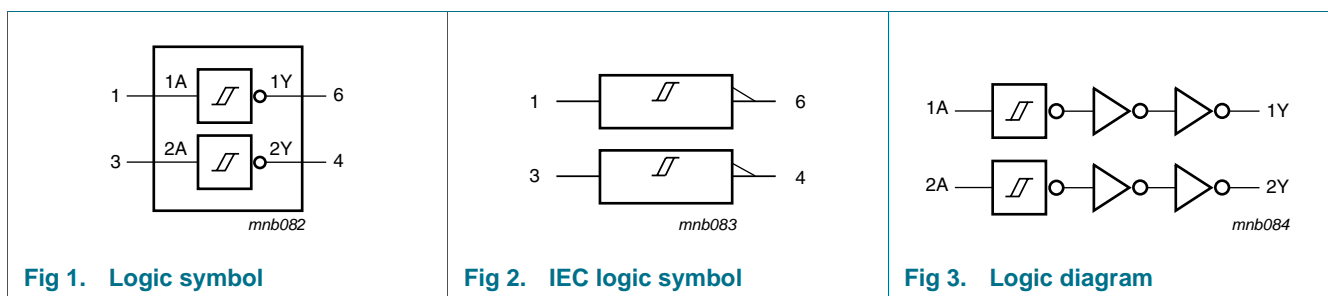

7. Pinning information

7.1 Pinning

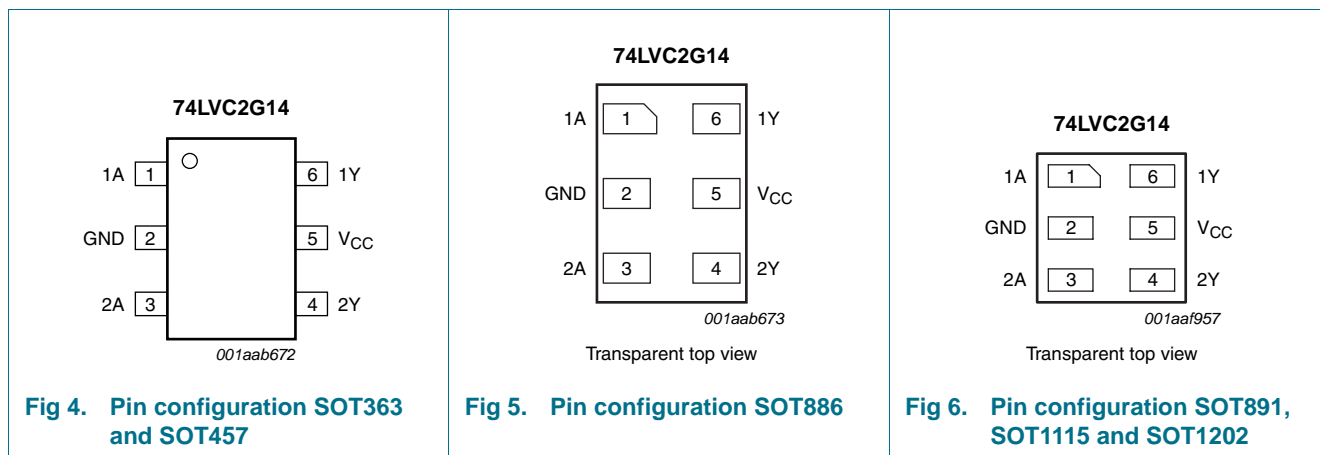

7.2 Pin description

Table 3. Pin description

| Symbol | Pin | Description |
|-----------------|-----|----------------|
| 1A | 1 | data input |
| GND | 2 | ground (0 V) |
| 2A | 3 | data input |
| 2Y | 4 | data output |
| V _{CC} | 5 | supply voltage |
| 1Y | 6 | data input |

8. Functional description

Table 4. Function table^[1]

| Input | Output |
|-------|--------|
| nA | nY |
| L | H |
| H | L |

[1] H = HIGH voltage level;
L = LOW voltage level.

9. Limiting values

Table 5. Limiting values

In accordance with the Absolute Maximum Rating System (IEC 60134). Voltages are referenced to GND (ground = 0 V).

| Symbol | Parameter | Conditions | Min | Max | Unit |
|-----------|-------------------------|---------------------------------|-------------|----------------|------|
| V_{CC} | supply voltage | | -0.5 | +6.5 | V |
| I_{IK} | input clamping current | $V_I < 0$ V | -50 | - | mA |
| V_I | input voltage | | [1] -0.5 | +6.5 | V |
| I_{OK} | output clamping current | $V_O > V_{CC}$ or $V_O < 0$ V | - | ± 50 | mA |
| V_O | output voltage | Active mode | [1][2] -0.5 | $V_{CC} + 0.5$ | V |
| | | Power-down mode | [1][2] -0.5 | +6.5 | V |
| I_O | output current | $V_O = 0$ V to V_{CC} | - | ± 50 | mA |
| I_{CC} | supply current | | - | 100 | mA |
| I_{GND} | ground current | | -100 | - | mA |
| P_{tot} | total power dissipation | $T_{amb} = -40$ °C to $+125$ °C | [3] - | 250 | mW |
| T_{stg} | storage temperature | | -65 | +150 | °C |

[1] The input and output voltage ratings may be exceeded if the input and output current ratings are observed.

[2] When $V_{CC} = 0$ V (Power-down mode), the output voltage can be 5.5 V in normal operation.

[3] For SC-88 and SC-74A packages: above 87.5 °C the value of P_{tot} derates linearly with 4.0 mW/K.
For XSON6 packages: above 45 °C the value of P_{tot} derates linearly with 2.4 mW/K.

10. Recommended operating conditions

Table 6. Recommended operating conditions

| Symbol | Parameter | Conditions | Min | Typ | Max | Unit |
|-----------|---------------------|---------------------------------|------|-----|----------|------|
| V_{CC} | supply voltage | | 1.65 | - | 5.5 | V |
| V_I | input voltage | | 0 | - | 5.5 | V |
| V_O | output voltage | Active mode | 0 | - | V_{CC} | V |
| | | Power-down mode; $V_{CC} = 0$ V | 0 | - | 5.5 | V |
| T_{amb} | ambient temperature | | -40 | - | +125 | °C |

11. Static characteristics

Table 7. Static characteristics

At recommended operating conditions; voltages are referenced to GND (ground = 0 V).

| Symbol | Parameter | Conditions | Min | Typ ^[1] | Max | Unit |
|--|---------------------------|---|-----------------------|--------------------|------|------|
| T_{amb} = -40 °C to +85 °C | | | | | | |
| V _{OH} | HIGH-level output voltage | V _I = V _{CC} or GND | | | | |
| | | I _O = -100 μA; V _{CC} = 1.65 V to 5.5 V | V _{CC} - 0.1 | - | - | V |
| | | I _O = -4 mA; V _{CC} = 1.65 V | 1.2 | - | - | V |
| | | I _O = -8 mA; V _{CC} = 2.3 V | 1.9 | - | - | V |
| | | I _O = -12 mA; V _{CC} = 2.7 V | 2.2 | - | - | V |
| | | I _O = -24 mA; V _{CC} = 3.0 V | 2.3 | - | - | V |
| | | I _O = -32 mA; V _{CC} = 4.5 V | 3.8 | - | - | V |
| V _{OL} | LOW-level output voltage | V _I = V _{CC} or GND | | | | |
| | | I _O = 100 μA; V _{CC} = 1.65 V to 5.5 V | - | - | 0.1 | V |
| | | I _O = 4 mA; V _{CC} = 1.65 V | - | - | 0.45 | V |
| | | I _O = 8 mA; V _{CC} = 2.3 V | - | - | 0.3 | V |
| | | I _O = 12 mA; V _{CC} = 2.7 V | - | - | 0.4 | V |
| | | I _O = 24 mA; V _{CC} = 3.0 V | - | - | 0.55 | V |
| | | I _O = 32 mA; V _{CC} = 4.5 V | - | - | 0.55 | V |
| I _I | input leakage current | V _I = 5.5 V or GND; V _{CC} = 0 V to 5.5 V | - | ±0.1 | ±5 | μA |
| I _{OFF} | power-off leakage current | V _I or V _O = 5.5 V; V _{CC} = 0 V | - | ±0.1 | ±10 | μA |
| I _{CC} | supply current | V _I = 5.5 V or GND; V _{CC} = 1.65 V to 5.5 V; I _O = 0 A | - | 0.1 | 10 | μA |
| ΔI _{CC} | additional supply current | V _I = V _{CC} - 0.6 V; I _O = 0 A; V _{CC} = 2.3 V to 5.5 V | - | 5 | 500 | μA |
| C _I | input capacitance | V _{CC} = 3.3 V; V _I = GND to V _{CC} | - | 3.5 | - | pF |
| T_{amb} = -40 °C to +125 °C | | | | | | |
| V _{OH} | HIGH-level output voltage | V _I = V _{CC} or GND | | | | |
| | | I _O = -100 μA; V _{CC} = 1.65 V to 5.5 V | V _{CC} - 0.1 | - | - | V |
| | | I _O = -4 mA; V _{CC} = 1.65 V | 0.95 | - | - | V |
| | | I _O = -8 mA; V _{CC} = 2.3 V | 1.7 | - | - | V |
| | | I _O = -12 mA; V _{CC} = 2.7 V | 1.9 | - | - | V |
| | | I _O = -24 mA; V _{CC} = 3.0 V | 2.0 | - | - | V |
| | | I _O = -32 mA; V _{CC} = 4.5 V | 3.4 | - | - | V |
| V _{OL} | LOW-level output voltage | V _I = V _{CC} or GND | | | | |
| | | I _O = 100 μA; V _{CC} = 1.65 V to 5.5 V | - | - | 0.1 | V |
| | | I _O = 4 mA; V _{CC} = 1.65 V | - | - | 0.7 | V |
| | | I _O = 8 mA; V _{CC} = 2.3 V | - | - | 0.45 | V |
| | | I _O = 12 mA; V _{CC} = 2.7 V | - | - | 0.6 | V |
| | | I _O = 24 mA; V _{CC} = 3.0 V | - | - | 0.8 | V |
| | | I _O = 32 mA; V _{CC} = 4.5 V | - | - | 0.8 | V |
| I _I | input leakage current | V _I = 5.5 V or GND; V _{CC} = 0 V to 5.5 V | - | - | ±20 | μA |

Table 7. Static characteristics ...continued

At recommended operating conditions; voltages are referenced to GND (ground = 0 V).

| Symbol | Parameter | Conditions | Min | Typ [1] | Max | Unit |
|-----------------|---------------------------|---|-----|---------|----------|---------|
| I_{OFF} | power-off leakage current | V_I or $V_O = 5.5$ V; $V_{CC} = 0$ V | - | - | ± 20 | μ A |
| I_{CC} | supply current | $V_I = 5.5$ V or GND; $V_{CC} = 1.65$ V to 5.5 V; $I_O = 0$ A | - | - | 40 | μ A |
| ΔI_{CC} | additional supply current | $V_I = V_{CC} - 0.6$ V; $I_O = 0$ A; $V_{CC} = 2.3$ V to 5.5 V | - | - | 5000 | μ A |

[1] All typical values are measured at maximum V_{CC} and $T_{amb} = 25$ °C.

Table 8. Transfer characteristics

Voltages are referenced to GND (ground = 0 V; for test circuit see [Figure 8](#))

| Symbol | Parameter | Conditions | -40 °C to +85 °C | | | -40 °C to +125 °C | | Unit |
|----------|----------------------------------|---|------------------|---------|------|-------------------|------|------|
| | | | Min | Typ [1] | Max | Min | Max | |
| V_{T+} | positive-going threshold voltage | see Figure 9 and Figure 10 | | | | | | |
| | | $V_{CC} = 1.8$ V | 0.70 | 1.10 | 1.50 | 0.70 | 1.70 | V |
| | | $V_{CC} = 2.3$ V | 1.00 | 1.40 | 1.80 | 1.00 | 2.00 | V |
| | | $V_{CC} = 3.0$ V | 1.30 | 1.76 | 2.20 | 1.30 | 2.40 | V |
| | | $V_{CC} = 4.5$ V | 1.90 | 2.47 | 3.10 | 1.90 | 3.30 | V |
| V_{T-} | negative-going threshold voltage | see Figure 9 and Figure 10 | | | | | | |
| | | $V_{CC} = 1.8$ V | 0.25 | 0.61 | 0.90 | 0.25 | 1.10 | V |
| | | $V_{CC} = 2.3$ V | 0.40 | 0.80 | 1.15 | 0.40 | 1.35 | V |
| | | $V_{CC} = 3.0$ V | 0.60 | 1.04 | 1.50 | 0.60 | 1.70 | V |
| | | $V_{CC} = 4.5$ V | 1.00 | 1.55 | 2.00 | 1.00 | 2.20 | V |
| V_H | hysteresis voltage | $(V_{T+} - V_{T-})$; see Figure 9 , Figure 10 and Figure 11 | | | | | | |
| | | $V_{CC} = 1.8$ V | 0.15 | 0.49 | 1.00 | 0.15 | 1.20 | V |
| | | $V_{CC} = 2.3$ V | 0.25 | 0.60 | 1.10 | 0.25 | 1.30 | V |
| | | $V_{CC} = 3.0$ V | 0.40 | 0.73 | 1.20 | 0.40 | 1.40 | V |
| | | $V_{CC} = 4.5$ V | 0.60 | 0.92 | 1.50 | 0.60 | 1.70 | V |
| | | $V_{CC} = 5.5$ V | 0.70 | 1.02 | 1.70 | 0.70 | 1.90 | V |

[1] All typical values are measured at $T_{amb} = 25$ °C

12. Dynamic characteristics

Table 9. Dynamic characteristics

Voltages are referenced to GND (ground = 0 V). For test circuit see [Figure 8](#).

| Symbol | Parameter | Conditions | -40 °C to +85 °C | | | -40 °C to +125 °C | | Unit |
|-----------------|-------------------------------|--|------------------|--------------------|------|-------------------|------|------|
| | | | Min | Typ ^[1] | Max | Min | Max | |
| t _{pd} | propagation delay | nA to nY; see Figure 7 ^[2] | | | | | | |
| | | V _{CC} = 1.65 V to 1.95 V | 1.0 | 5.6 | 11.0 | 1.0 | 12.0 | ns |
| | | V _{CC} = 2.3 V to 2.7 V | 0.5 | 3.7 | 6.5 | 0.5 | 7.2 | ns |
| | | V _{CC} = 2.7 V | 0.5 | 4.1 | 7.0 | 0.5 | 7.7 | ns |
| | | V _{CC} = 3.0 V to 3.6 V | 0.5 | 3.9 | 6.0 | 0.5 | 6.7 | ns |
| | | V _{CC} = 4.5 V to 5.5 V | 0.5 | 2.7 | 4.3 | 0.5 | 4.7 | ns |
| C _{PD} | power dissipation capacitance | V _I = GND to V _{CC} ; V _{CC} = 3.3 V ^[3] | - | 18.1 | - | - | - | pF |

[1] Typical values are measured at T_{amb} = 25 °C and V_{CC} = 1.8 V, 2.5 V, 2.7 V, 3.3 V and 5.0 V respectively.

[2] t_{pd} is the same as t_{PLH} and t_{PHL}.

[3] C_{PD} is used to determine the dynamic power dissipation (P_D in μW).

$$P_D = C_{PD} \times V_{CC}^2 \times f_i \times N + \sum(C_L \times V_{CC}^2 \times f_o) \text{ where:}$$

f_i = input frequency in MHz;

f_o = output frequency in MHz;

C_L = output load capacitance in pF;

V_{CC} = supply voltage in V;

N = number of inputs switching;

∑(C_L × V_{CC}² × f_o) = sum of outputs.

13. Waveforms

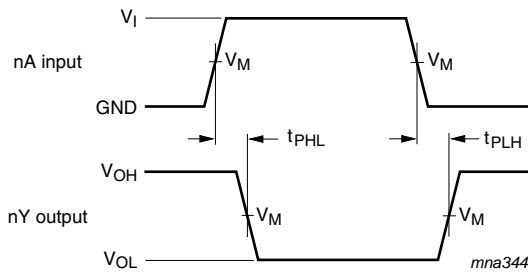

Measurement points are given in [Table 10](#).

V_{OL} and V_{OH} are typical output voltage levels that occur with the output load.

Fig 7. The data input (nA) to output (nY) propagation delays

Table 10. Measurement points

| Supply voltage | Input | Output |
|------------------|---------------------|---------------------|
| V_{CC} | V_M | V_M |
| 1.65 V to 1.95 V | $0.5 \times V_{CC}$ | $0.5 \times V_{CC}$ |
| 2.3 V to 2.7 V | $0.5 \times V_{CC}$ | $0.5 \times V_{CC}$ |
| 2.7 V | 1.5 V | 1.5 V |
| 3.0 V to 3.6 V | 1.5 V | 1.5 V |
| 4.5 V to 5.5 V | $0.5 \times V_{CC}$ | $0.5 \times V_{CC}$ |

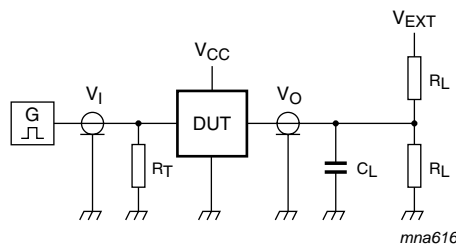

Test data is given in [Table 11](#).

Definitions for test circuit:

R_L = Load resistance.

C_L = Load capacitance including jig and probe capacitance.

R_T = Termination resistance should be equal to the output impedance Z_o of the pulse generator.

V_{EXT} = External voltage for measuring switching times.

Fig 8. Load circuitry for switching times

Table 11. Test data

| Supply voltage | Input | | Load | | V_{EXT} |
|------------------|----------|---------------|-------|--------------|--------------------|
| V_{CC} | V_I | $t_r = t_f$ | C_L | R_L | t_{PLH}, t_{PHL} |
| 1.65 V to 1.95 V | V_{CC} | ≤ 2.0 ns | 30 pF | 1 k Ω | open |
| 2.3 V to 2.7 V | V_{CC} | ≤ 2.0 ns | 30 pF | 500 Ω | open |
| 2.7 V | 2.7 V | ≤ 2.5 ns | 50 pF | 500 Ω | open |
| 3.0 V to 3.6 V | 2.7 V | ≤ 2.5 ns | 50 pF | 500 Ω | open |
| 4.5 V to 5.5 V | V_{CC} | ≤ 2.5 ns | 50 pF | 500 Ω | open |

14. Waveforms transfer characteristics

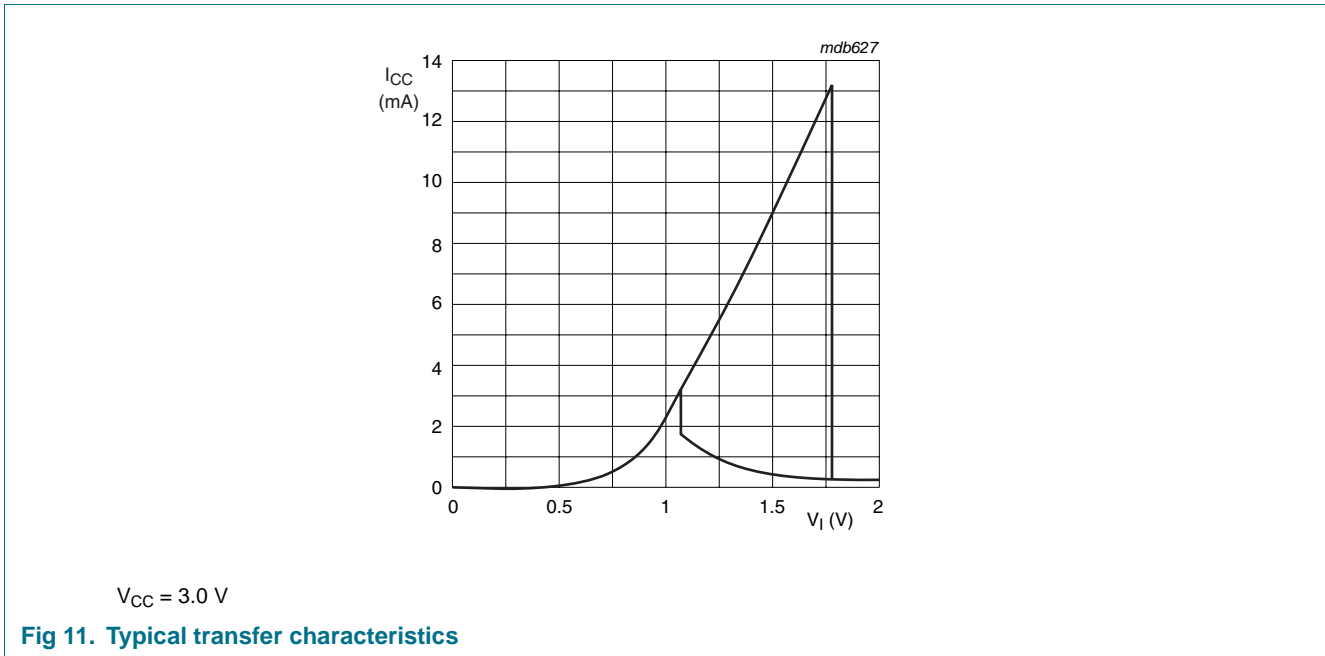
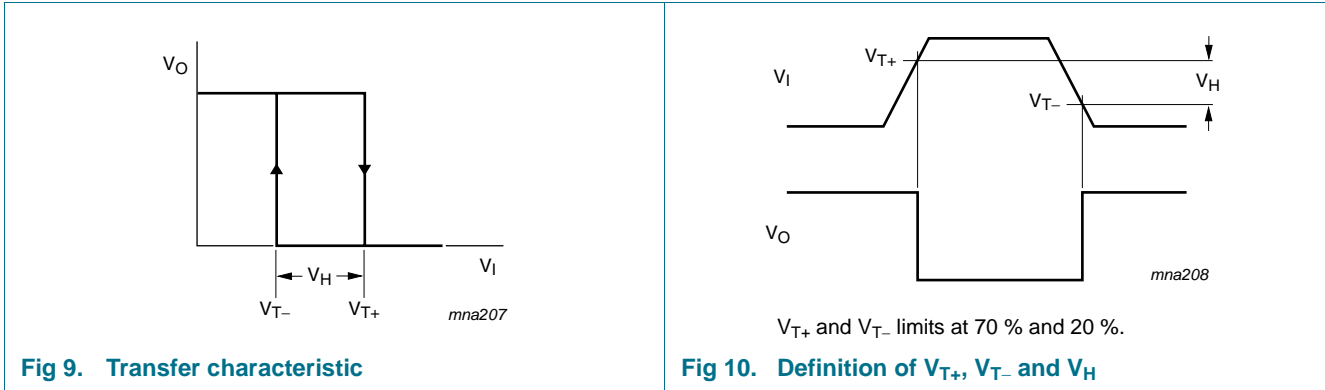

15. Application information

The slow input rise and fall times cause additional power dissipation, which can be calculated using the following formula:

$$P_{add} = f_i \times (t_r \times \Delta I_{CC(AV)} + t_f \times \Delta I_{CC(AV)}) \times V_{CC} \text{ where:}$$

P_{add} = additional power dissipation (μW);

f_i = input frequency (MHz);

t_r = input rise time (ns); 10 % to 90 %;

t_f = input fall time (ns); 90 % to 10 %;

$\Delta I_{CC(AV)}$ = average additional supply current (μA).

$\Delta I_{CC(AV)}$ differs with positive or negative input transitions, as shown in [Figure 12](#).

An example of a relaxation circuit using the 74LVC2G14 is shown in [Figure 13](#).

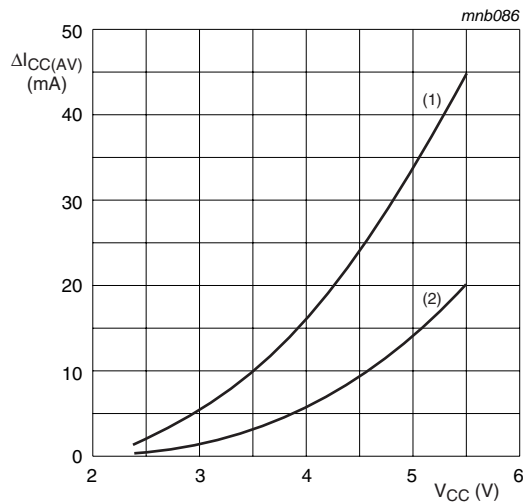

Linear change of V_I between 0.8 V to 2.0 V. All values given are typical unless otherwise specified.

- (1) Positive-going edge.
- (2) Negative-going edge.

Fig 12. Average I_{CC} as a function of V_{CC}

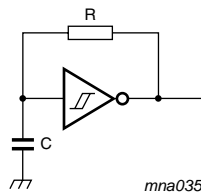

$$f = \frac{1}{T} \approx \frac{1}{0.8 \times RC}$$

Fig 13. Relaxation oscillator

16. Package outline

Plastic surface-mounted package; 6 leads

SOT363

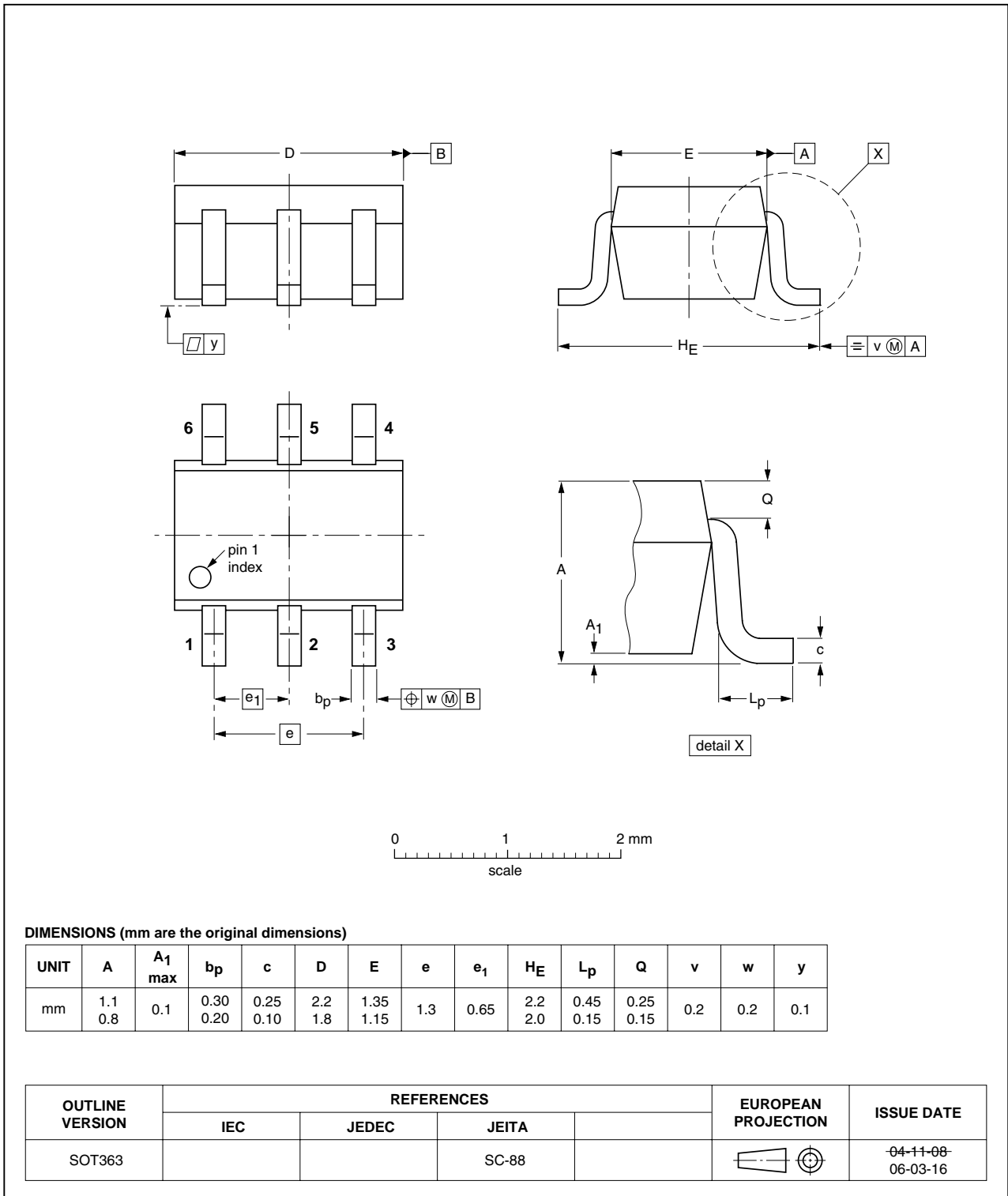

Fig 14. Package outline SOT363 (SC-88)

Plastic surface-mounted package (TSOP6); 6 leads

SOT457

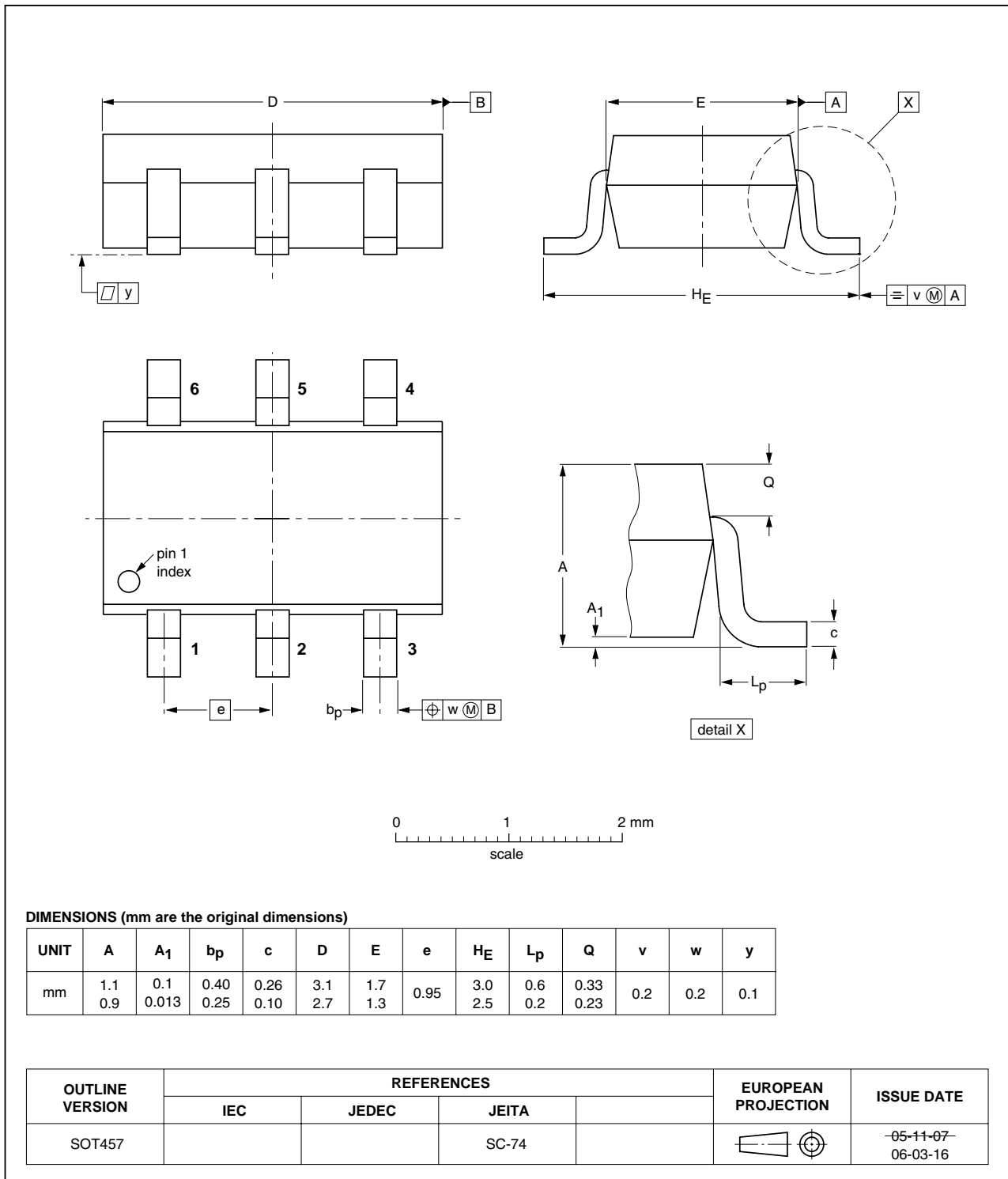

Fig 15. Package outline SOT457 (SC-74)

XSON6: plastic extremely thin small outline package; no leads; 6 terminals; body 1 x 1.45 x 0.5 mm

SOT886

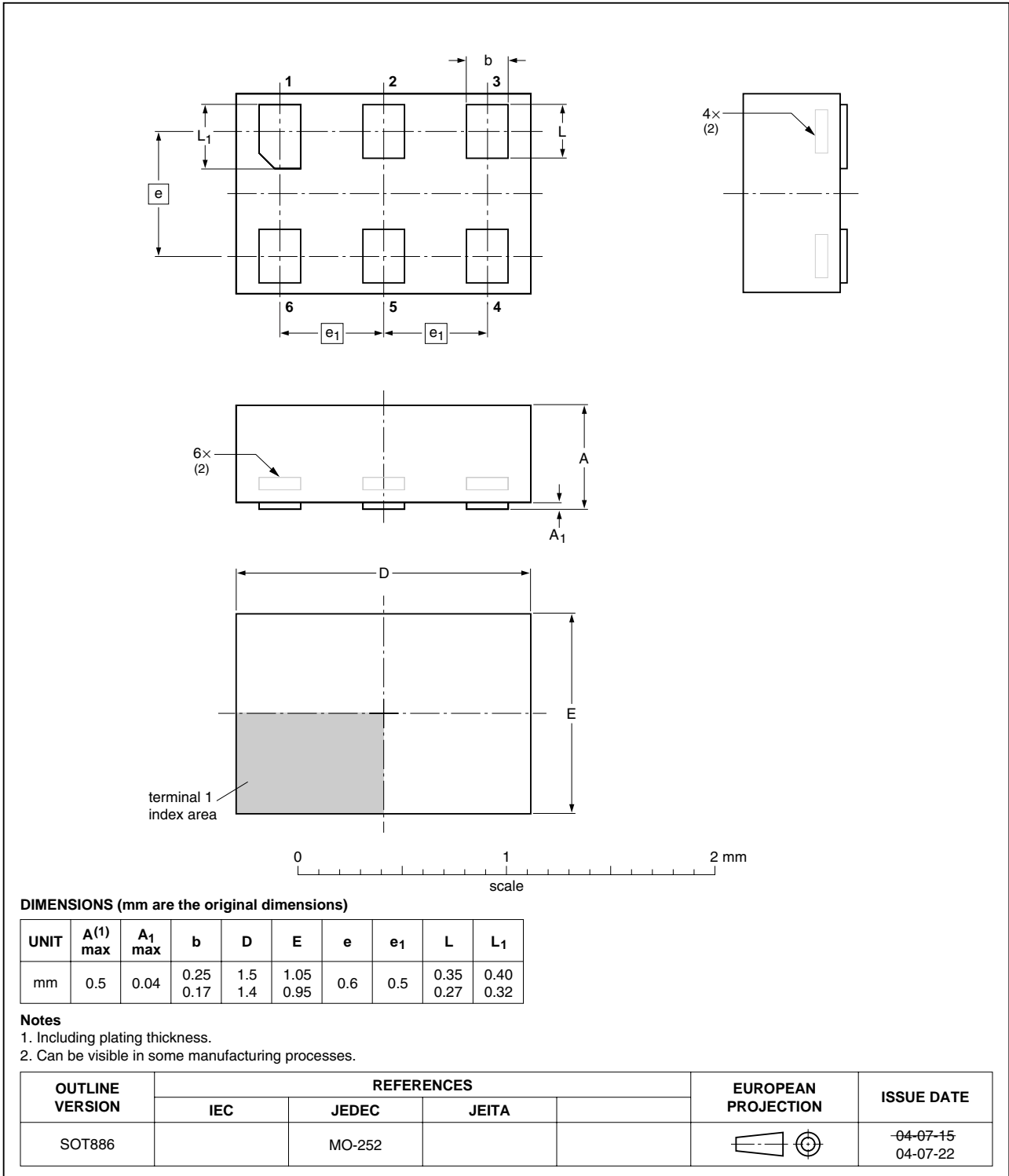

Fig 16. Package outline SOT886 (XSON6)

XSON6: plastic extremely thin small outline package; no leads; 6 terminals; body 1 x 1 x 0.5 mm

SOT891

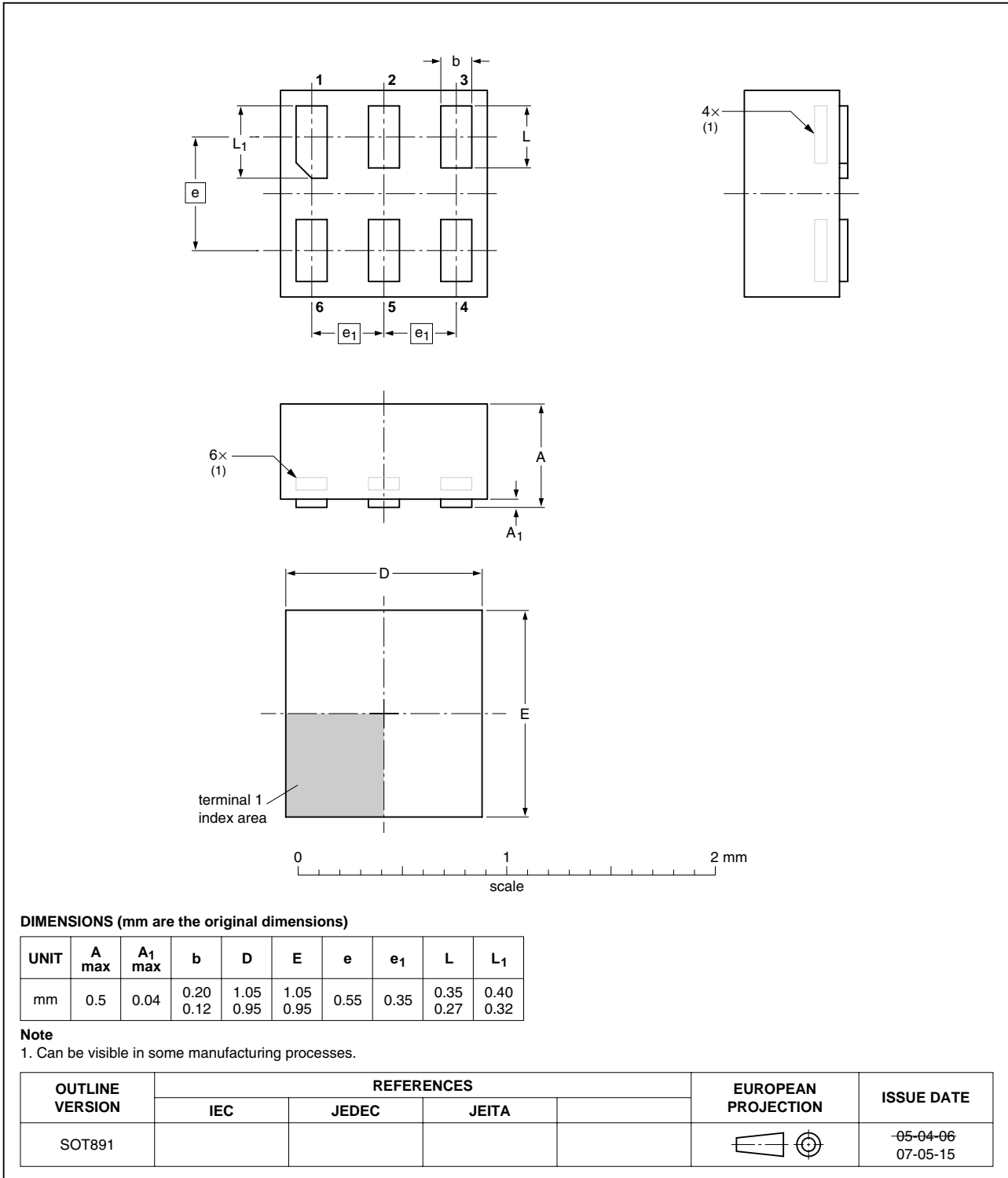

Fig 17. Package outline SOT891 (XSON6)

XSON6: extremely thin small outline package; no leads;
6 terminals; body 0.9 x 1.0 x 0.35 mm

SOT1115

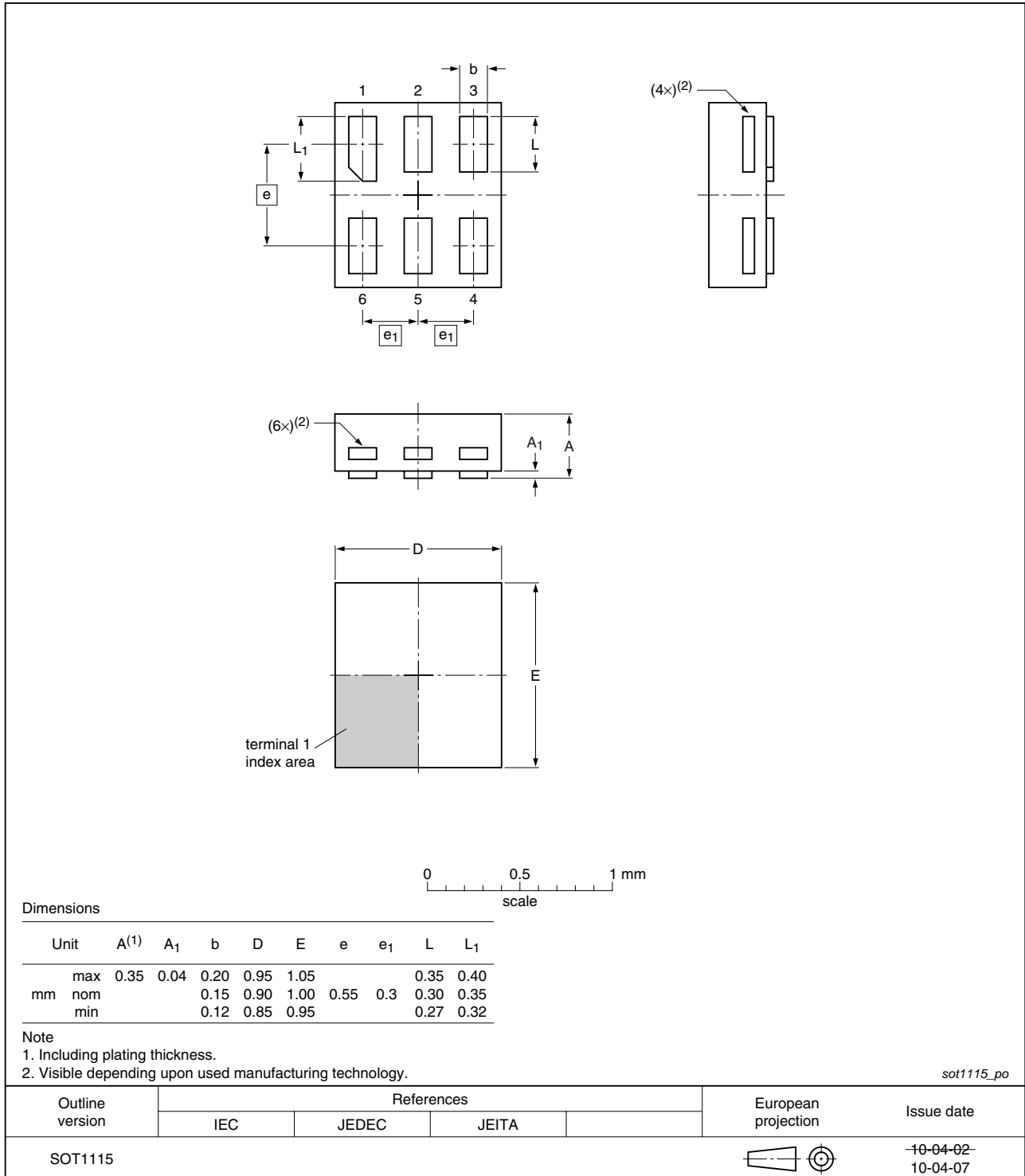

Fig 18. Package outline SOT1115 (XSON6)

XSON6: extremely thin small outline package; no leads;
6 terminals; body 1.0 x 1.0 x 0.35 mm

SOT1202

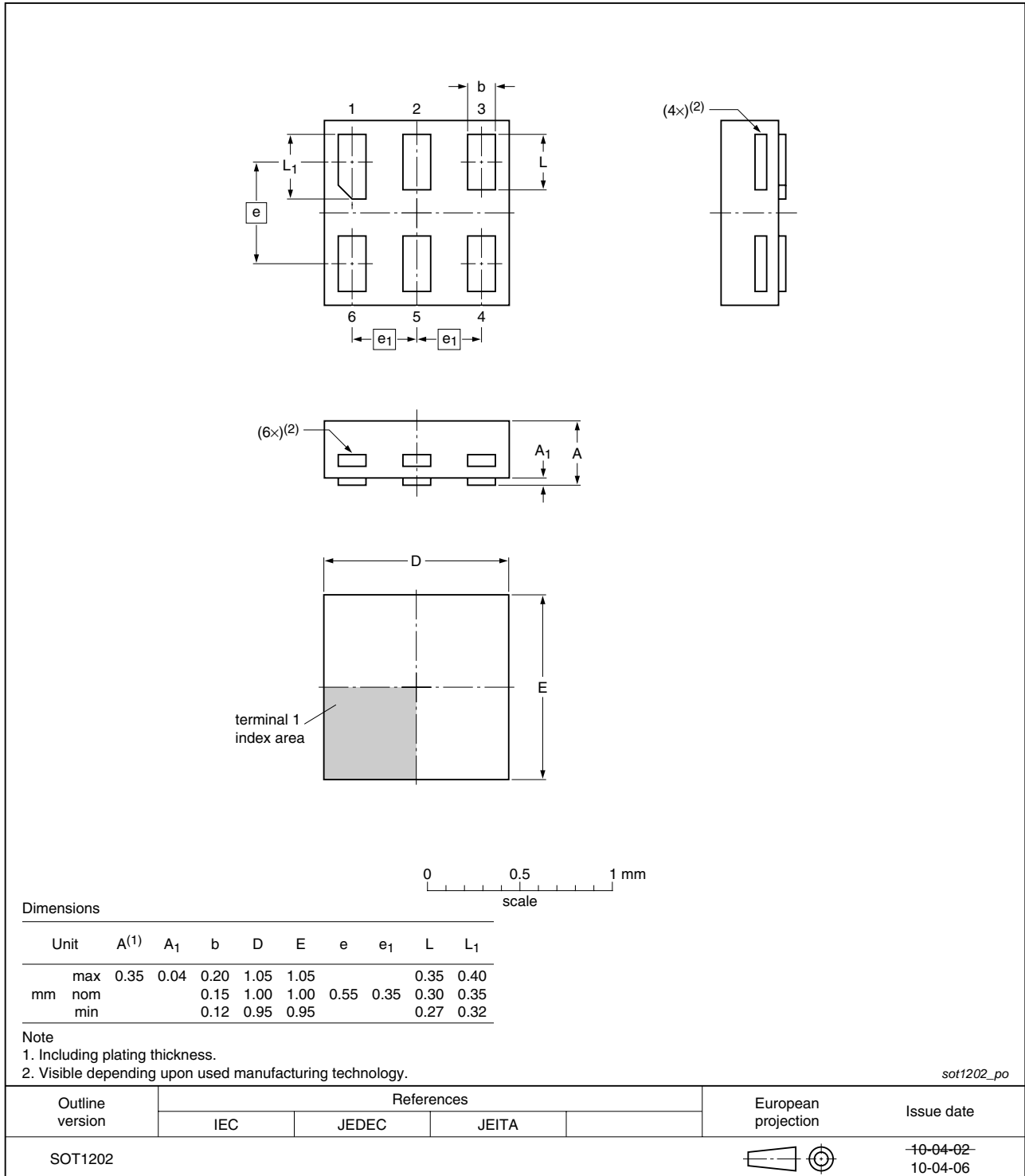

Fig 19. Package outline SOT1202 (XSON6)

17. Abbreviations

Table 12. Abbreviations

| Acronym | Description |
|---------|---|
| CMOS | Complementary Metal Oxide Semiconductor |
| TTL | Transistor-Transistor Logic |
| HBM | Human Body Model |
| ESD | ElectroStatic Discharge |
| MM | Machine Model |
| DUT | Device Under Test |

18. Revision history

Table 13. Revision history

| Document ID | Release date | Data sheet status | Change notice | Supersedes |
|----------------|--|-----------------------|---------------|---------------|
| 74LVC2G14 v.5 | 20101029 | Product data sheet | | 74LVC2G14 v.4 |
| Modifications: | <ul style="list-style-type: none"> Added type number 74LVC2G14GN (SOT1115/XSON6 package). Added type number 74LVC2G14GS (SOT1202/XSON6 package). | | | |
| 74LVC2G14 v.4 | 20070904 | Product data sheet | | 74LVC2G14 v.3 |
| 74LVC2G14 v.3 | 20070220 | Product data sheet | | 74LVC2G14 v.2 |
| 74LVC2G14 v.2 | 20040908 | Product specification | - | 74LVC2G14 v.1 |
| 74LVC2G14 v.1 | 20030731 | Product specification | | - |

19. Legal information

19.1 Data sheet status

| Document status ^{[1][2]} | Product status ^[3] | Definition |
|-----------------------------------|-------------------------------|---|
| Objective [short] data sheet | Development | This document contains data from the objective specification for product development. |
| Preliminary [short] data sheet | Qualification | This document contains data from the preliminary specification. |
| Product [short] data sheet | Production | This document contains the product specification. |

[1] Please consult the most recently issued document before initiating or completing a design.

[2] The term 'short data sheet' is explained in section "Definitions".

[3] The product status of device(s) described in this document may have changed since this document was published and may differ in case of multiple devices. The latest product status information is available on the Internet at URL <http://www.nxp.com>.

19.2 Definitions

Draft — The document is a draft version only. The content is still under internal review and subject to formal approval, which may result in modifications or additions. NXP Semiconductors does not give any representations or warranties as to the accuracy or completeness of information included herein and shall have no liability for the consequences of use of such information.

Short data sheet — A short data sheet is an extract from a full data sheet with the same product type number(s) and title. A short data sheet is intended for quick reference only and should not be relied upon to contain detailed and full information. For detailed and full information see the relevant full data sheet, which is available on request via the local NXP Semiconductors sales office. In case of any inconsistency or conflict with the short data sheet, the full data sheet shall prevail.

Product specification — The information and data provided in a Product data sheet shall define the specification of the product as agreed between NXP Semiconductors and its customer, unless NXP Semiconductors and customer have explicitly agreed otherwise in writing. In no event however, shall an agreement be valid in which the NXP Semiconductors product is deemed to offer functions and qualities beyond those described in the Product data sheet.

19.3 Disclaimers

Limited warranty and liability — Information in this document is believed to be accurate and reliable. However, NXP Semiconductors does not give any representations or warranties, expressed or implied, as to the accuracy or completeness of such information and shall have no liability for the consequences of use of such information.

In no event shall NXP Semiconductors be liable for any indirect, incidental, punitive, special or consequential damages (including - without limitation - lost profits, lost savings, business interruption, costs related to the removal or replacement of any products or rework charges) whether or not such damages are based on tort (including negligence), warranty, breach of contract or any other legal theory.

Notwithstanding any damages that customer might incur for any reason whatsoever, NXP Semiconductors' aggregate and cumulative liability towards customer for the products described herein shall be limited in accordance with the *Terms and conditions of commercial sale* of NXP Semiconductors.

Right to make changes — NXP Semiconductors reserves the right to make changes to information published in this document, including without limitation specifications and product descriptions, at any time and without notice. This document supersedes and replaces all information supplied prior to the publication hereof.

Suitability for use in automotive applications — This NXP Semiconductors product has been qualified for use in automotive applications. The product is not designed, authorized or warranted to be

suitable for use in medical, military, aircraft, space or life support equipment, nor in applications where failure or malfunction of an NXP Semiconductors product can reasonably be expected to result in personal injury, death or severe property or environmental damage. NXP Semiconductors accepts no liability for inclusion and/or use of NXP Semiconductors products in such equipment or applications and therefore such inclusion and/or use is at the customer's own risk.

Applications — Applications that are described herein for any of these products are for illustrative purposes only. NXP Semiconductors makes no representation or warranty that such applications will be suitable for the specified use without further testing or modification.

Customers are responsible for the design and operation of their applications and products using NXP Semiconductors products, and NXP Semiconductors accepts no liability for any assistance with applications or customer product design. It is customer's sole responsibility to determine whether the NXP Semiconductors product is suitable and fit for the customer's applications and products planned, as well as for the planned application and use of customer's third party customer(s). Customers should provide appropriate design and operating safeguards to minimize the risks associated with their applications and products.

NXP Semiconductors does not accept any liability related to any default, damage, costs or problem which is based on any weakness or default in the customer's applications or products, or the application or use by customer's third party customer(s). Customer is responsible for doing all necessary testing for the customer's applications and products using NXP Semiconductors products in order to avoid a default of the applications and the products or of the application or use by customer's third party customer(s). NXP does not accept any liability in this respect.

Limiting values — Stress above one or more limiting values (as defined in the Absolute Maximum Ratings System of IEC 60134) will cause permanent damage to the device. Limiting values are stress ratings only and (proper) operation of the device at these or any other conditions above those given in the Recommended operating conditions section (if present) or the Characteristics sections of this document is not warranted. Constant or repeated exposure to limiting values will permanently and irreversibly affect the quality and reliability of the device.

Terms and conditions of commercial sale — NXP Semiconductors products are sold subject to the general terms and conditions of commercial sale, as published at <http://www.nxp.com/profile/terms>, unless otherwise agreed in a valid written individual agreement. In case an individual agreement is concluded only the terms and conditions of the respective agreement shall apply. NXP Semiconductors hereby expressly objects to applying the customer's general terms and conditions with regard to the purchase of NXP Semiconductors products by customer.

No offer to sell or license — Nothing in this document may be interpreted or construed as an offer to sell products that is open for acceptance or the grant, conveyance or implication of any license under any copyrights, patents or other industrial or intellectual property rights.

Export control — This document as well as the item(s) described herein may be subject to export control regulations. Export might require a prior authorization from national authorities.

19.4 Trademarks

Notice: All referenced brands, product names, service names and trademarks are the property of their respective owners.

20. Contact information

For more information, please visit: <http://www.nxp.com>

For sales office addresses, please send an email to: salesaddresses@nxp.com

21. Contents

| | | |
|------|--|----|
| 1 | General description | 1 |
| 2 | Features and benefits | 1 |
| 3 | Applications | 1 |
| 4 | Ordering information | 2 |
| 5 | Marking | 2 |
| 6 | Functional diagram | 2 |
| 7 | Pinning information | 3 |
| 7.1 | Pinning | 3 |
| 7.2 | Pin description | 3 |
| 8 | Functional description | 3 |
| 9 | Limiting values | 4 |
| 10 | Recommended operating conditions | 4 |
| 11 | Static characteristics | 5 |
| 12 | Dynamic characteristics | 7 |
| 13 | Waveforms | 7 |
| 14 | Waveforms transfer characteristics | 9 |
| 15 | Application information | 10 |
| 16 | Package outline | 11 |
| 17 | Abbreviations | 17 |
| 18 | Revision history | 17 |
| 19 | Legal information | 18 |
| 19.1 | Data sheet status | 18 |
| 19.2 | Definitions | 18 |
| 19.3 | Disclaimers | 18 |
| 19.4 | Trademarks | 19 |
| 20 | Contact information | 19 |
| 21 | Contents | 20 |

Please be aware that important notices concerning this document and the product(s) described herein, have been included in section 'Legal information'.

© NXP B.V. 2010.

All rights reserved.

For more information, please visit: <http://www.nxp.com>

For sales office addresses, please send an email to: salesaddresses@nxp.com

Date of release: 29 October 2010

Document identifier: 74LVC2G14