

# Mono 7W Class D Amplifier

## General Description

The MAX9737 mono 7W Class D amplifier provides a high-performance, thermally efficient amplifier solution that offers up to 88% efficiency at a 12V supply. The device operates from 8V to 28V and provides a high 80dB PSRR, eliminating the need for a regulated power supply.

Filterless modulation allows the MAX9737 to pass CE EMI limits with 1m cables using only a low-cost ferrite bead and small-value capacitor on each output.

Comprehensive click-and-pop suppression circuitry reduces noise on power-up/down or into and out of shutdown or mute.

An input op amp allows the user to create a lowpass or highpass filter, and select an optimal gain. The internal precharge circuit ensures clickless/popless turn-on within 10ms.

The MAX9737 is available in the 24-pin, TQFN-EP package and is specified over the -40°C to +85°C temperature range.

## Applications

2.1 Notebook PCs  
LCD/PDP/CRT Monitors  
PC Surround Speakers  
MP3 Docking Stations

## Features

- ◆ 8V to 28V Supply Voltage Range
- ◆ Spread-Spectrum Modulation Enables Low-EMI Solution
- ◆ Passes EMI Limit with Up to 1m of Speaker Cable
- ◆ High 80dB PSRR
- ◆ Up to 88% Efficiency Eliminates Heatsink
- ◆ Thermal and Output Current Protection
- ◆ < 1µA Shutdown Mode
- ◆ Click-and-Pop Suppression
- ◆ < 10ms Turn-On Time
- ◆ Space-Saving, 4mm x 4mm x 0.8mm, 24-Pin TQFN Package

## Ordering Information

PART	TEMP RANGE	PIN-PACKAGE
MAX9737ETG+	-40°C to +85°C	24 TQFN-EP*

+Denotes a lead-free/RoHS-compliant package.

\*EP = Exposed pad.

## Simplified Diagram

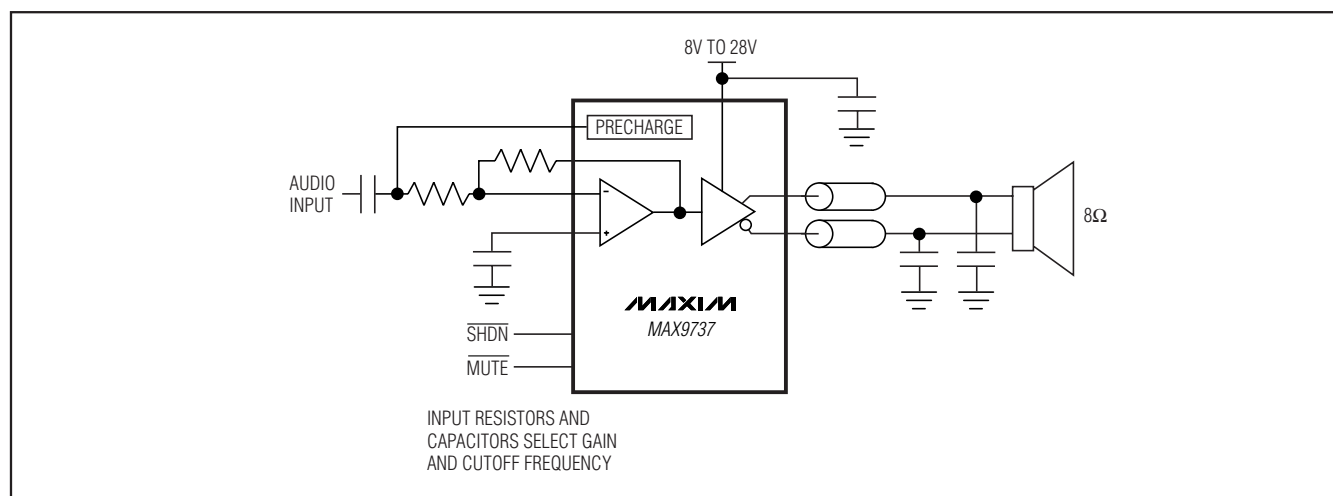

Pin Configuration and Typical Application Circuit appear at end of data sheet.

# Mono 7W Class D Amplifier

## ABSOLUTE MAXIMUM RATINGS

PVDD to PGND	-0.3V to +30V
AGND to PGND	-0.3V to +0.3V
IN, PRE, PC, COM to AGND	-0.3V to (V <sub>REG</sub> + 0.3V)
MUTE, SHDN to AGND	-0.3V to +6V
REG to AGND	-0.3V to (V <sub>S</sub> + 0.3V)
V <sub>S</sub> to AGND	-0.3V to +6V
OUT+, OUT- to PGND	-0.3V to (PVDD + 0.3V)
C1N to PGND	-0.3V to (PVDD + 0.3V)
C1P to PGND	(PVDD - 0.3V) to (V <sub>CHOLD</sub> + 0.3V)
CHOLD to PGND	(V <sub>C1P</sub> - 0.3V) to +36V
OUT+, OUT-, Short Circuit to PGND or PVDD	Continuous
Thermal Limits (Notes 1, 2)	
Continuous Power Dissipation (T <sub>A</sub> = +70°C)	
24-Pin TQFN Single-Layer PCB (derate 20.8mW/°C above +70°C)	1666.7mW
θ <sub>JA</sub>	48°C/W
θ <sub>JC</sub>	3°C/W

Continuous Power Dissipation	
24-Pin TQFN Multiple-Layer PCB (derate 27.8mW/°C above +70°C)	2222.2mW
θ <sub>JA</sub>	36°C/W
θ <sub>JC</sub>	3°C/W
Operating Temperature Range	-40°C to +85°C
Storage Temperature Range	-65°C to +150°C
Junction Temperature	+150°C
Lead Temperature (soldering, 10s)	+300°C

**Note 1:** Thermal performance of this device is highly dependent on PCB layout. See the *Applications Information* section for more detail.

**Note 2:** Package thermal resistances were obtained using the method described in JEDEC specification JESD51-7, using a four-layer board. For detailed information on package thermal considerations, refer to [www.maxim-ic.com/thermal-tutorial](http://www.maxim-ic.com/thermal-tutorial).

Stresses beyond those listed under "Absolute Maximum Ratings" may cause permanent damage to the device. These are stress ratings only, and functional operation of the device at these or any other conditions beyond those indicated in the operational sections of the specifications is not implied. Exposure to absolute maximum rating conditions for extended periods may affect device reliability.

## ELECTRICAL CHARACTERISTICS

(V<sub>PVDD</sub> = 12V, V<sub>AGND</sub> = V<sub>PGND</sub> = 0, V<sub>SHDN</sub> = V<sub>MUTE</sub> = 5V, C<sub>1</sub> = 0.1μF, C<sub>IN</sub> = 0.47μF, C<sub>2</sub> = C<sub>COM</sub> = C<sub>REG</sub> = 1μF, R<sub>IN</sub> = R<sub>FB</sub> = 20kΩ, R<sub>L</sub> = ∞, AC measurement bandwidth 22Hz to 22kHz, T<sub>A</sub> = T<sub>MIN</sub> to T<sub>MAX</sub>, unless otherwise noted. Typical values are at T<sub>A</sub> = +25°C.) (Note 3)

PARAMETER	SYMBOL	CONDITIONS	MIN	TYP	MAX	UNITS
<b>AMPLIFIER DC CHARACTERISTICS</b>						
Speaker-Supply Voltage Range	PVDD	Inferred from PSRR test	8		28	V
Undervoltage Lockout	UVLO			6.8		V
Quiescent Supply Current	I <sub>PVDD</sub>	T <sub>A</sub> = +25°C		15	20	mA
					25	
Shutdown Supply Current	I <sub>SHDN</sub>	V <sub>SHDN</sub> = 0, T <sub>A</sub> = +25°C		1	10	μA
REG Voltage	V <sub>REG</sub>		4.0	4.2	4.5	V
Preregulator Voltage	V <sub>S</sub>			4.85		V
COM Voltage	V <sub>COM</sub>		1.94	2.06	2.16	V
<b>INPUT AMPLIFIER CHARACTERISTICS</b>						
Capacitive Drive	C <sub>L</sub>	No sustained oscillation		30		pF
Output Swing		Sinking ±1mA (Note 4)		2.05		V
Open-Loop Gain	A <sub>VO</sub>			88		dB
Input Offset Voltage	V <sub>OS</sub>	IN to COM		±2		mV
Input Amplifier Slew Rate				2.5		V/μs
Input Amplifier Unity-Gain Bandwidth				3.5		MHz

# Mono 7W Class D Amplifier

## ELECTRICAL CHARACTERISTICS (continued)

( $V_{PVDD} = 12V$ ,  $V_{AGND} = V_{PGND} = 0$ ,  $V_{SHDN} = V_{MUTE} = 5V$ ,  $C_1 = 0.1\mu F$ ,  $C_{IN} = 0.47\mu F$ ,  $C_2 = C_{COM} = C_{REG} = 1\mu F$ ,  $R_{IN} = R_{FB} = 20k\Omega$ ,  $R_L = \infty$ , AC measurement bandwidth 22Hz to 22kHz,  $T_A = T_{MIN}$  to  $T_{MAX}$ , unless otherwise noted. Typical values are at  $T_A = +25^\circ C$ .) (Note 3)

PARAMETER	SYMBOL	CONDITIONS	MIN	TYP	MAX	UNITS
<b>OUTPUT AMPLIFIER CHARACTERISTICS</b>						
Output Amplifier Gain	$A_V$	Preamplifier gain = 0dB (Note 7)	13.1	13.6	14.1	dB
Output Current Limit			3	4.6		A
Output Offset	$V_{OS}$	OUT+ to OUT-, $T_A = +25^\circ C$		$\pm 2$	$\pm 10$	mV
Power-Supply Rejection Ratio	PSRR	$V_{PVDD} = 8V$ to $28V$ , $T_A = +25^\circ C$	65	80		dB
		$f = 1kHz$ , 100mV <sub>p-p</sub> ripple		88		
Output Power	$P_{OUT}$	THD+N = 10%, $R_L = 8\Omega$ (Note 5)	6	7.4		W
		THD+N = 10%, $R_L = 4\Omega$ (Note 6)		13		
THD + Noise	THD+N	$P_{OUT} = 2W$ , $f = 1kHz$ , $R_L = 8\Omega$ (Note 5)		0.06		%
Signal-to-Noise Ratio	SNR	A-weighted, $P_{OUT} = THD+N$ at 1%, $f_{IN} = 1kHz$		97		dB
Noise	$V_N$	A-weighted (Note 4)		100		$\mu V_{RMS}$
Efficiency	$\eta$	$P_{OUT} = 4W$		85		%
Click-and-Pop Level	$K_{CP}$	Peak voltage, 32 samples/second, A-weighted (Notes 4, 5, 8)	Into shutdown	38		dBV
			Out of shutdown	38		
			Into mute	38		
			Out of mute	38		
Switching Frequency			270	300	330	kHz
Spread-Spectrum Bandwidth				$\pm 4$		kHz
Thermal-Shutdown Level				+160		$^\circ C$
Thermal-Shutdown Hysteresis				30		$^\circ C$
Turn-On Time	$t_{ON}$	From shutdown to full operation		9	10	ms
<b>DIGITAL INTERFACE (SHDN, MUTE)</b>						
Input-Voltage High	$V_{INH}$		2			V
Input-Voltage Low	$V_{INL}$				0.8	V
Input-Voltage Hysteresis				50		mV
Input Leakage Current		$T_A = +25^\circ C$			$\pm 10$	$\mu A$

**Note 3:** All devices are 100% production tested at  $T_A = +25^\circ C$ , and all temperature limits are guaranteed by design.

**Note 4:** Amplifier inputs AC-coupled to GND.

**Note 5:**  $8\Omega$  resistive load in series with 68mH inductive load connected across OUT+ and OUT- outputs.

**Note 6:**  $4\Omega$  resistive load in series with 33 $\mu H$  inductive load connected across OUT+ and OUT- outputs for  $V_{PVDD} \leq 12V$ .

**Note 7:** Output amplifier gain is defined as:

$$20 \times \log \left( \frac{|(V_{OUT+}) - (V_{OUT-})|}{|V_{PRE}|} \right)$$

**Note 8:** Mode transition controlled by  $\overline{SHDN}$  and  $\overline{MUTE}$ .

# Mono 7W Class D Amplifier

## Typical Operating Characteristics

( $V_{PVDD} = 12V$ ,  $V_{GND} = V_{PGND} = 0$ ,  $V_{SHDN} = V_{MUTE} = 5V$ ,  $R_{IN} = R_{FB} = 20k\Omega$ , unless otherwise noted.)

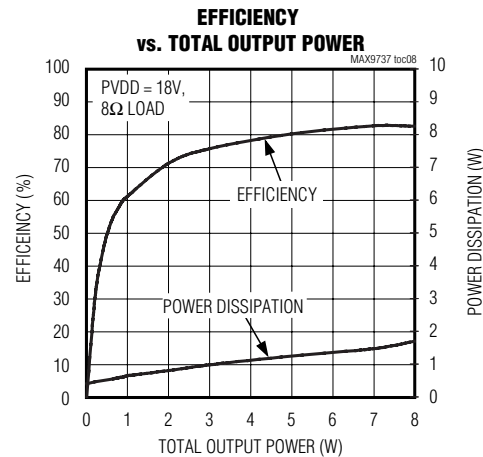
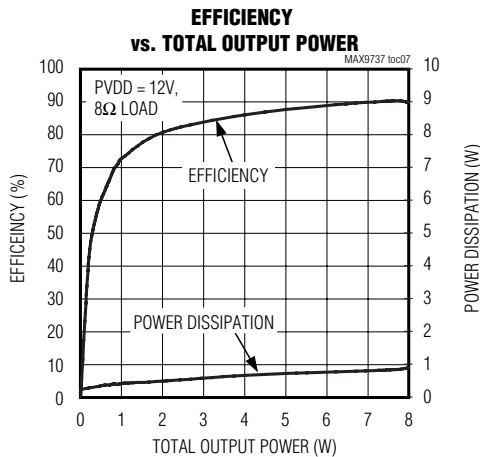
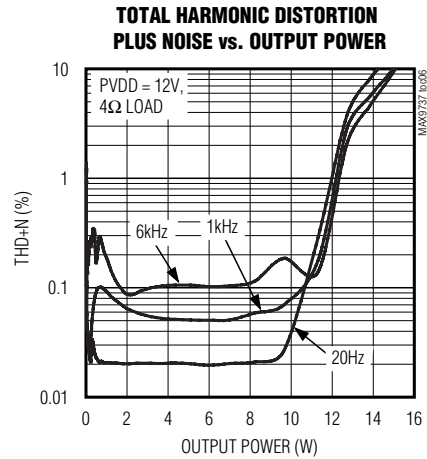
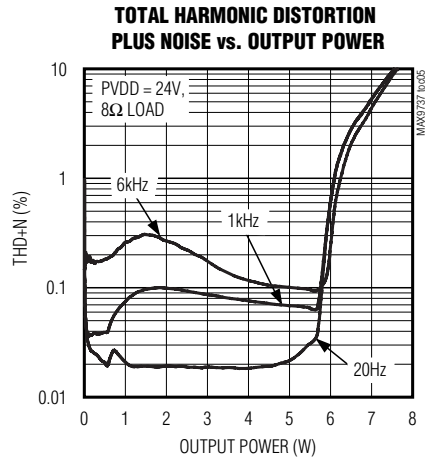
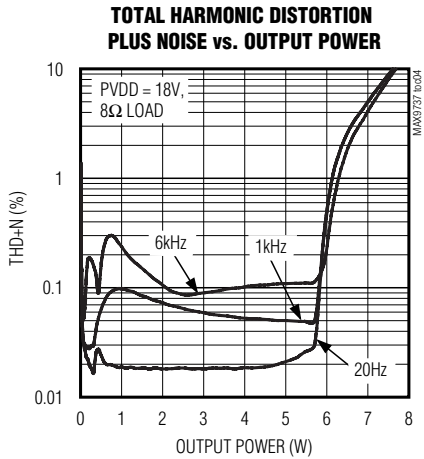
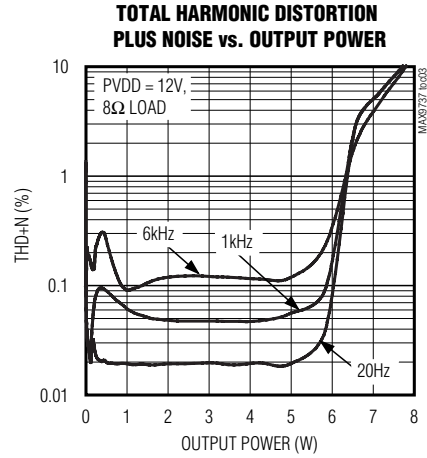
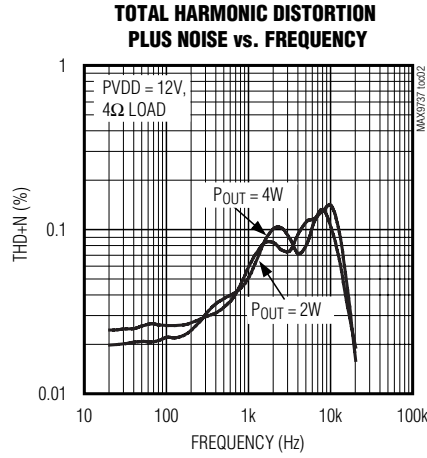
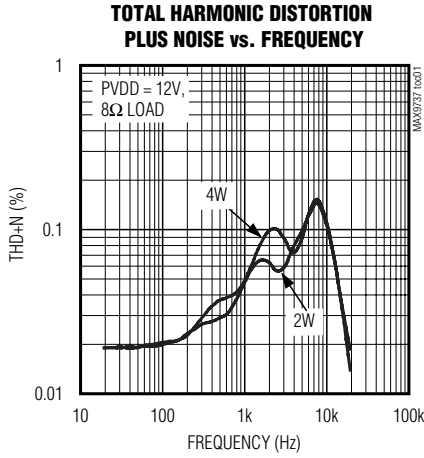

# Mono 7W Class D Amplifier

MAX9737

## Typical Operating Characteristics (continued)

( $V_{PVDD} = 12V$ ,  $V_{GND} = V_{PGND} = 0$ ,  $V_{SHDN} = V_{MUTE} = 5V$ ,  $R_{IN} = R_{FB} = 20k\Omega$ , unless otherwise noted.)

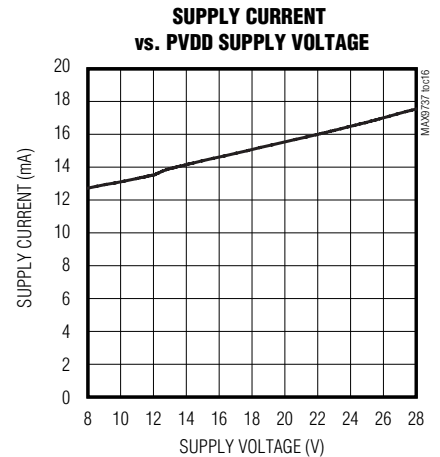
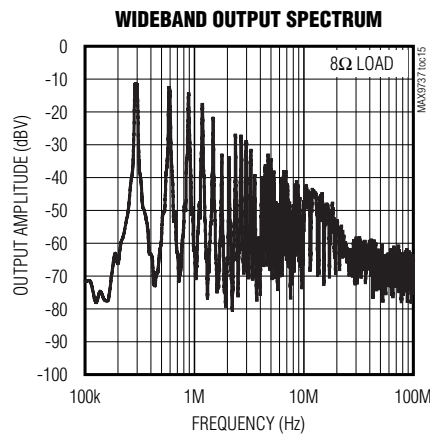
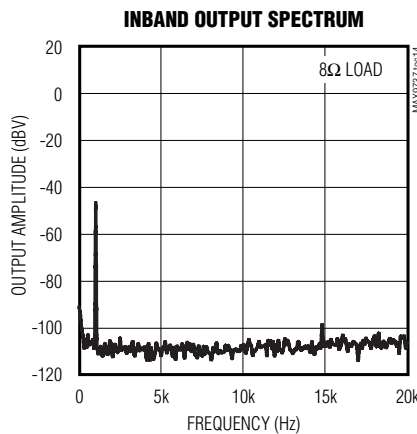
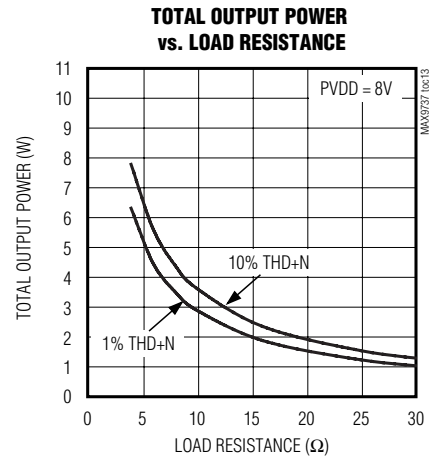
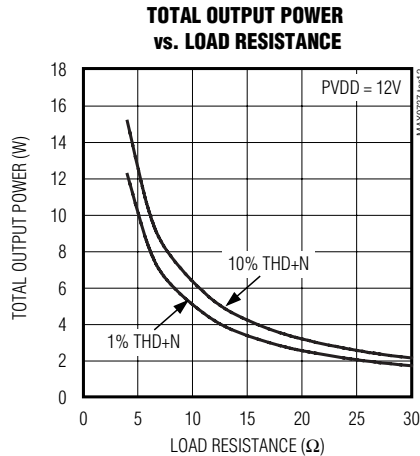
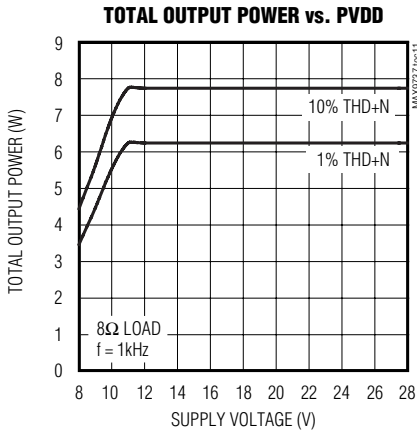
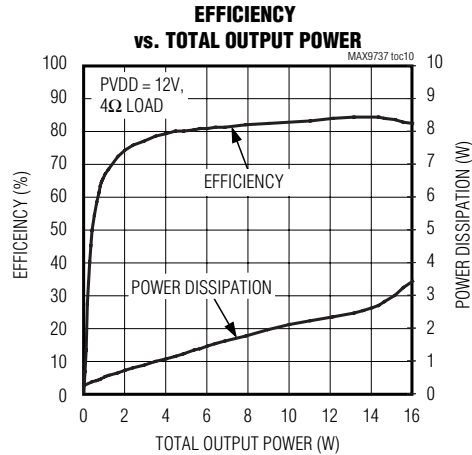
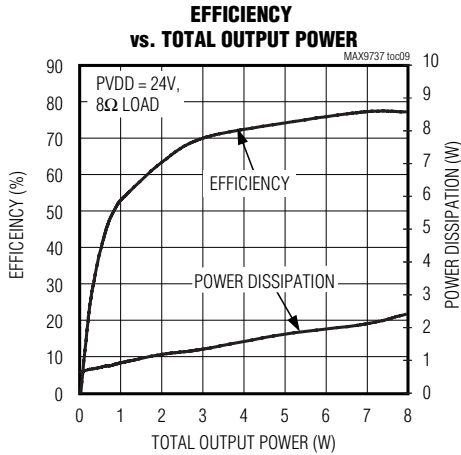

# Mono 7W Class D Amplifier

## Typical Operating Characteristics (continued)

( $V_{PVDD} = 12V$ ,  $V_{GND} = V_{PGND} = 0$ ,  $V_{\overline{SHDN}} = V_{\overline{MUTE}} = 5V$ ,  $R_{IN} = R_{FB} = 20k\Omega$ , unless otherwise noted.)

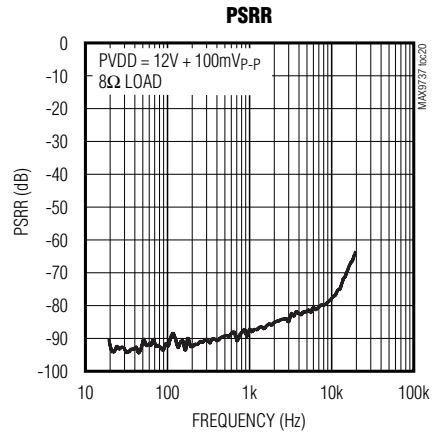
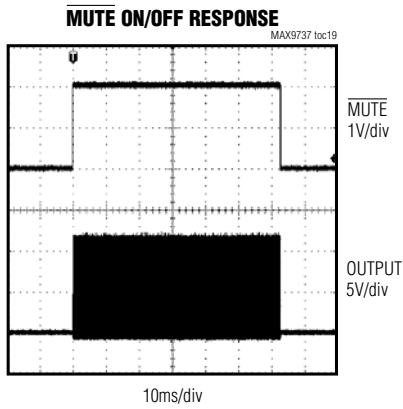
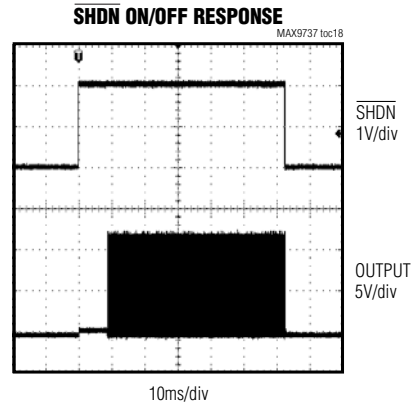
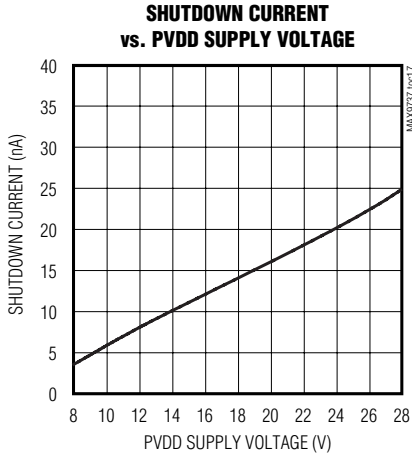

# Mono 7W Class D Amplifier

MAX9737

## Pin Description

PIN	NAME	FUNCTION
1, 17, 18	PVDD	Power Supply. Bypass PVDD to PGND with a 1 $\mu$ F capacitor connected to pin 1 and a 1 $\mu$ F capacitor connected to pins 17 and 18.
2	CHOLD	Charge-Pump Output. Connect a 1 $\mu$ F capacitor to PVDD.
3, 10, 11	AGND	Analog Ground
4	$\overline{\text{MUTE}}$	Mute Input. Drive $\overline{\text{MUTE}}$ low to place the device in mute mode.
5	$\overline{\text{SHDN}}$	Shutdown Input. Drive $\overline{\text{SHDN}}$ low to place the part in shutdown mode.
6	PC	Input Capacitor Precharge Connection. Connect between input resistor, R <sub>IN</sub> , and input coupling capacitor, C <sub>IN</sub> .
7	IN	Op Amp Inverting Input.
8	PRE	Op Amp Output. PRE is the output of the input operational amplifier.
9	COM	Internal 2.0V Bias. Bypass COM to AGND with a 1 $\mu$ F capacitor.
12	REG	Internal 4.2V Bias. Bypass REG to AGND with a 1 $\mu$ F capacitor.
13, 14	V <sub>S</sub>	Internal 5.0V Bias. Bypass V <sub>S</sub> to AGND with a 1 $\mu$ F capacitor.
15	C1N	Charge-Pump, Flying-Capacitor Negative Terminal. Connect C1N to C1P through a 0.1 $\mu$ F capacitor.
16	C1P	Charge-Pump, Flying-Capacitor Positive Terminal. Connect C1P to C1N through a 0.1 $\mu$ F capacitor.
19, 20	OUT-	Negative Speaker Output
21, 22	PGND	Power Ground
23, 24	OUT+	Positive Speaker Output
—	EP	Exposed Pad. Must be externally connected to PGND.

## Detailed Description

The MAX9737 filterless, mono class D audio power amplifier offers Class AB audio performance and Class D efficiency with minimal board space. The device operates from an 8V to 28V supply range.

The MAX9737 features filterless, spread-spectrum modulation, externally set gain and a low-power shutdown mode that reduces supply current to less than 1 $\mu$ A. Comprehensive click-and-pop suppression and precharge circuitry reduce noise into and out of shutdown or mute within 10ms.

### Spread-Spectrum Modulation

The MAX9737 features a unique spread-spectrum switching modulation that flattens EMI wideband spectral components, reducing radiated emissions from the speaker and cables. The switching frequency of the Class D amplifier varies randomly by  $\pm 4$ kHz around the 300kHz center frequency. Instead of a large amount of spectral energy present at multiples of the switching frequency, the energy is spread over a bandwidth that increases with frequency. Above a few MHz, the wideband spectrum looks like white noise for EMI purposes.

A proprietary amplifier topology ensures this white noise does not corrupt the noise floor in the audio bandwidth.

### Efficiency

The high efficiency of a Class D amplifier is due to the output transistors acting as switches and therefore consume negligible power. Power loss associated with the Class D output stage is due to the MOSFET I<sup>2</sup>R losses, switching losses, and quiescent current.

Although the theoretical best efficiency of a linear amplifier is 78% at peak output power, under typical music reproduction levels, the efficiency falls to below 40%. The MAX9737 exhibits > 80% efficiency under the same conditions (Figure 1).

### Shutdown

The MAX9737 features a shutdown mode that reduces power consumption to less than 1 $\mu$ A (typ), extending battery life in portable applications. Drive  $\overline{\text{SHDN}}$  low to place the device in low-power shutdown mode. In shutdown mode, the outputs are high impedance and the common-mode voltage at the output decays to zero.

# Mono 7W Class D Amplifier

## Mute Function

The MAX9737 features a mute mode where the signal is attenuated at the speaker and the outputs stop switching. To mute the MAX9737, drive MUTE low.

## Click-and-Pop Suppression

The MAX9737 features comprehensive click-and-pop suppression and precharge circuitry that reduce audible transients on startup and shutdown. The precharge circuit enables the amplifier within 10ms without any clicks or pops. Connect PC between the input resistor (R<sub>IN</sub>) and the input capacitor (C<sub>IN</sub>). For optimal click-and-pop suppression, use a 0.47μF input coupling capacitor (C<sub>IN</sub>).

## Current Limit

When output current exceeds the current limit, 4.6A (typ), the MAX9737 disables the outputs and initiates a 450μs startup sequence. The shutdown and startup sequence is repeated until the output fault is removed. Properly designed applications do not enter current-limit mode unless the output is short circuited or connected incorrectly.

## Thermal Shutdown

When the die temperature exceeds the thermal-shutdown threshold, +160°C (typ), the MAX9737 outputs are disabled. When the die temperature decreases by 30°C, normal operation resumes. Some causes of thermal shutdown are excessively low load impedance, poor thermal contact between the MAX9737's exposed pad and the PCB, elevated ambient temperature, or poor PCB layout and assembly.

## Applications Information

### Filterless Class D Operation

The MAX9737 meets EN55022B EMC radiation limits with an inexpensive ferrite bead and capacitor filter when the speaker leads are less than or equal to 1m (Figure 3). Select a ferrite bead with 100Ω to 600Ω impedance, and rated for 2A. The capacitor value varies based on the ferrite bead chosen and the speaker lead length. See Figure 2 for the correct connections of these components.

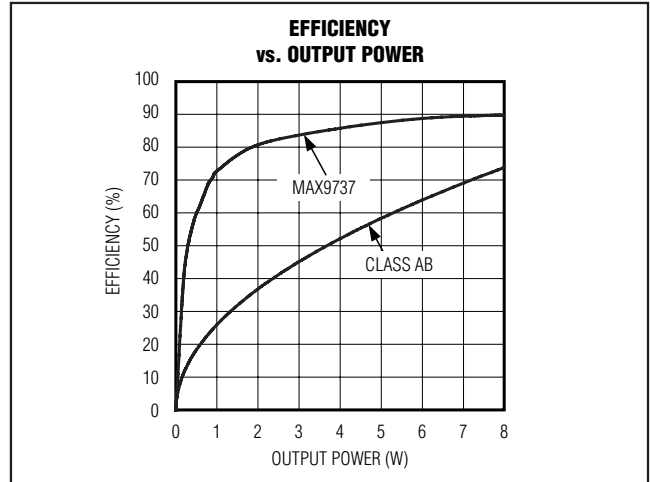

Figure 1. MAX9737 Efficiency vs. Class AB Efficiency

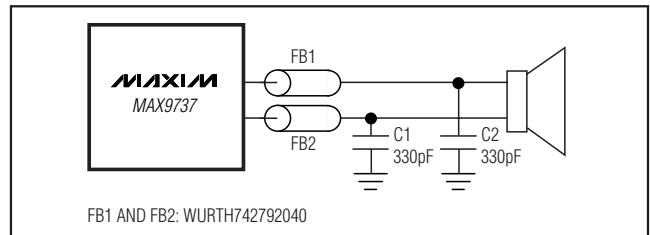

Figure 2. Ferrite Bead Filter Configuration

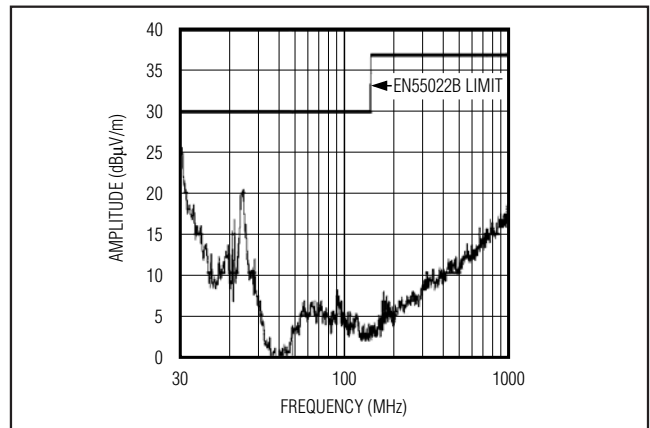

Figure 3. MAX9737 EMI Performance with 1m Twisted-Pair Speaker Cable

Table 1. Suggested Values for LC Filter

R <sub>L</sub> (Ω)	L1, L2 (μH)	C1 (μF)	C2, C3 (μF)	C4, C5 (μF)	R1, R2 (Ω)
4	10	0.47	0.10	0.22	10
8	15	0.15	0.15	0.15	15



# Mono 7W Class D Amplifier

MAX9737

When evaluating the MAX9737 with a ferrite bead filter and resistive load, include a series inductor (68μH for 8Ω load and 33μH for 4Ω load) to model typical loudspeaker's behavior. Omitting the series inductor reduces the efficiency, the THD+N performance and the output power of the MAX9737. When evaluating with a loudspeaker, no series inductor is required.

## Inductor-Based Output Filters

Some applications use the MAX9737 with a full inductor/capacitor-based (LC) output filter. See Figure 4 for the correct connections of these components.

The load impedance of the speaker determines the filter component selection (see Table 1).

Inductors L1 and L2 and capacitor C1 form the primary output filter. Capacitors C2 and C3 provide common-mode filtering to reduce radiated emissions. Capacitors C4 and C5, plus resistors R1 and R2, form a Zobel at the output. A Zobel corrects the output loading to compensate for the rising impedance of the loudspeaker. Without a Zobel, the filter exhibits peaking near the cut-off frequency.

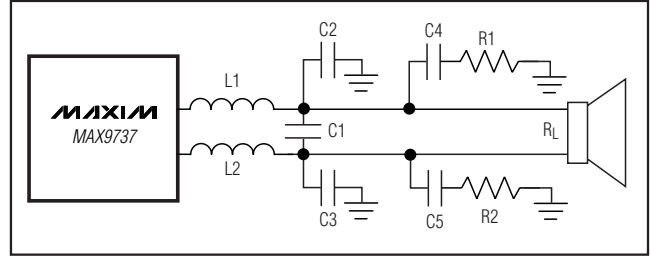

Figure 4. LC Filter Configuration

## Component Selection

### Gain-Setting Resistors

The output stage provides a fixed internal gain in addition to the externally set input stage gain. The fixed-output stage gain is set at 13.6dB (4.8V/V). Set overall gain by using resistors R<sub>F</sub> and R<sub>IN</sub> (Figure 5) as follows:

$$A_V = -4.8 \left( \frac{R_F}{R_{IN}} \right) V/V$$

where A<sub>V</sub> is the desired voltage gain. Choose R<sub>F</sub> between 10kΩ and 50kΩ.

The PRE terminal is an operational amplifier output, allowing the MAX9737 to be configured as a filter or an equalizer.

### Input Capacitor

An input capacitor, C<sub>IN</sub>, in conjunction with the input resistor, R<sub>IN</sub>, of the MAX9737 forms a highpass filter that removes the DC bias from an incoming signal. The AC-coupling capacitor allows the amplifier to bias the signal to an optimum DC level. Assuming negligible source impedance, the -3dB point of the highpass filter is given by:

$$f_{-3dB} = \frac{1}{2\pi R_{IN} C_{IN}}$$

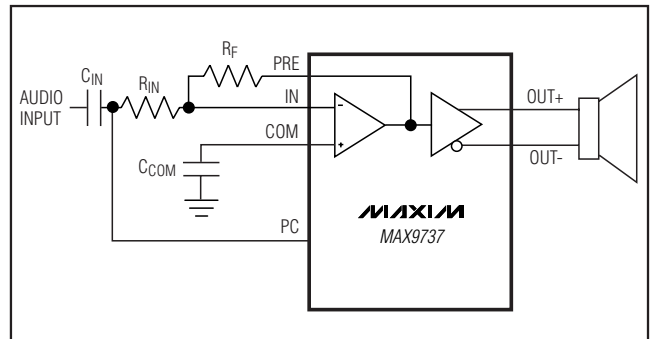

Figure 5. Preamplifier Gain Configuration

Choose C<sub>IN</sub> such that f<sub>-3dB</sub> is well below the lowest frequency of interest. To reduce low-frequency distortion, use capacitors whose dielectrics have low-voltage coefficients. Capacitors with high-voltage coefficients cause increased distortion close to f<sub>-3dB</sub>. For best click-and-pop suppression, use a 0.47μF input capacitor.

### COM Capacitor

COM is the output of the internally generated DC bias voltage. Bypass COM with a 1μF capacitor to AGND.

### Regulator Capacitor

REG is the output of the internally generated DC bias voltage. Bypass REG with a 1μF capacitor to AGND.

### Power Supplies

The MAX9737 features separate supplies for signal and power portions of the device, allowing for the optimum combination of headroom, power dissipation and noise immunity. The speaker amplifiers are powered from PVDD and can range from 8V to 28V. The remainder of the device is powered by an internal 5V regulator, V<sub>S</sub>.

### Internal Regulator

The MAX9737 features an internal 5V regulator, V<sub>S</sub>, powered from PVDD. Bypass V<sub>S</sub> with a 1μF capacitor to AGND.

# Mono 7W Class D Amplifier

## Typical Application Circuit

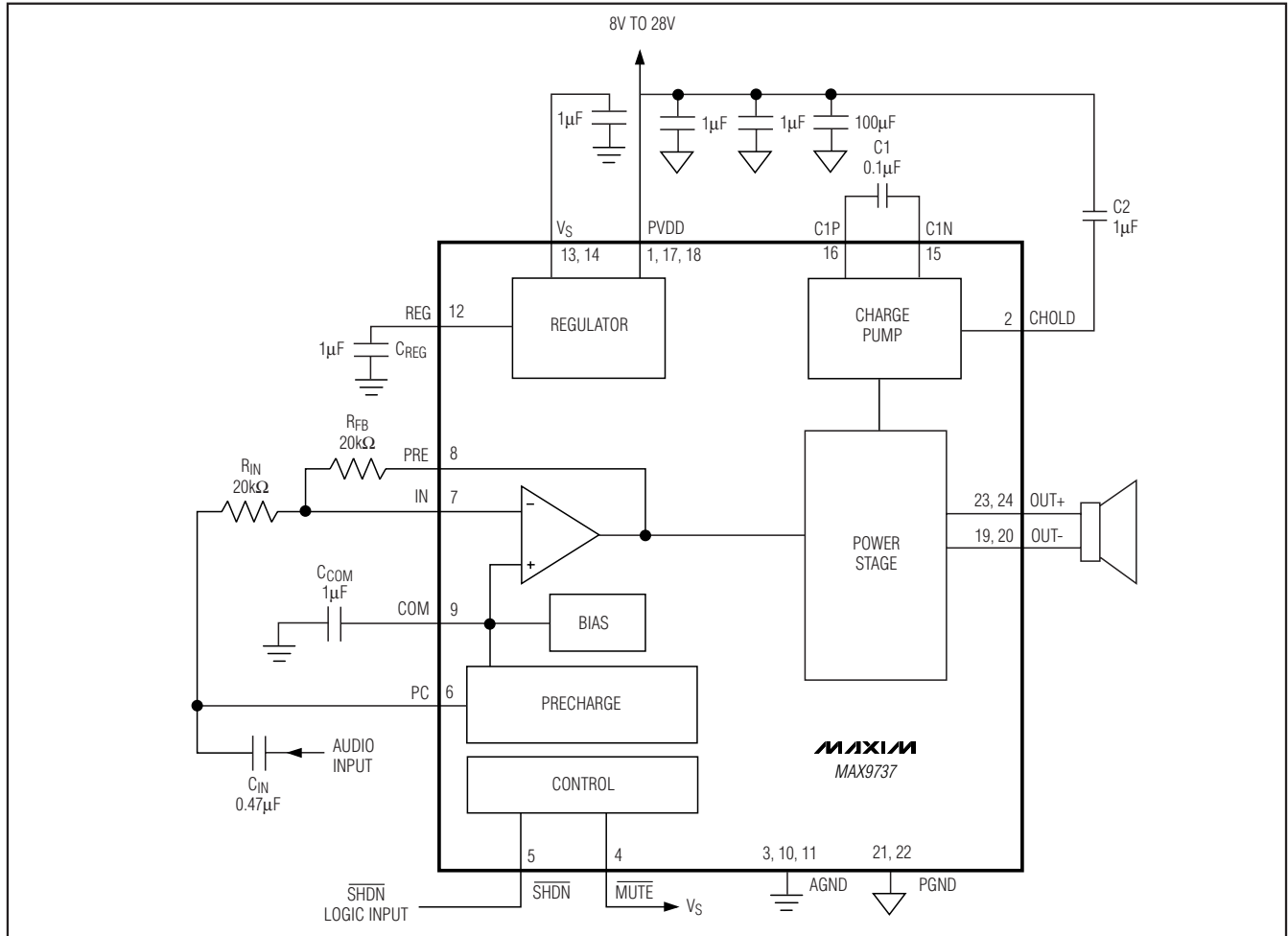

### Supply Bypassing, Layout, and Grounding

Proper layout and grounding are essential for optimum performance. Use wide traces for the power-supply inputs and amplifier outputs to minimize losses due to parasitic trace resistance. Proper grounding improves audio performance, minimizes crosstalk between channels, and prevents switching noise from coupling into the audio signal. Connect PGND and AGND at a single point on the PCB. Route all traces that carry switching transients away from AGND and the traces/components in the audio signal path.

Bypass PVDD with two 1µF capacitors to PGND. Place the bypass capacitors as close as possible to the MAX9737. Place a 100µF capacitor between PVDD and PGND. Bypass Vs, VCOM, and VREG with a 1µF capacitor to AGND.

Use wide, low-resistance output traces. Current drawn from the outputs increases as load impedance decreases. High-output trace resistance decreases the power delivered to the load. The MAX9737 TQFN package features an exposed thermal pad on its underside. This pad lowers the package's thermal resistance by providing a heat conduction path from the die to the PCB. Connect the exposed thermal pad to PGND by using a large pad and multiple vias to the PGND plane.

# Mono 7W Class D Amplifier

**MAX9737**

## Pin Configuration

## Chip Information

PROCESS: BiCMOS

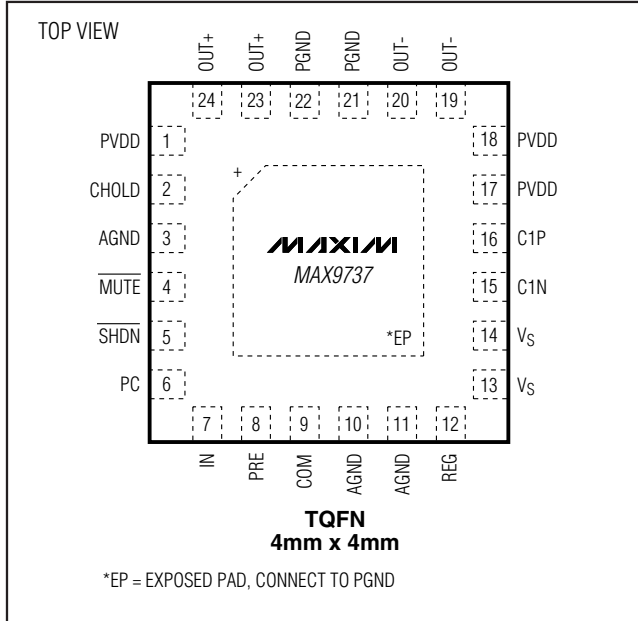

# Mono 7W Class D Amplifier

## Package Information

For the latest package outline information and land patterns, go to [www.maxim-ic.com/packages](http://www.maxim-ic.com/packages).

PACKAGE TYPE	PACKAGE CODE	DOCUMENT NO.
24 TQFN-EP	T2444+4	<a href="#">21-0139</a>

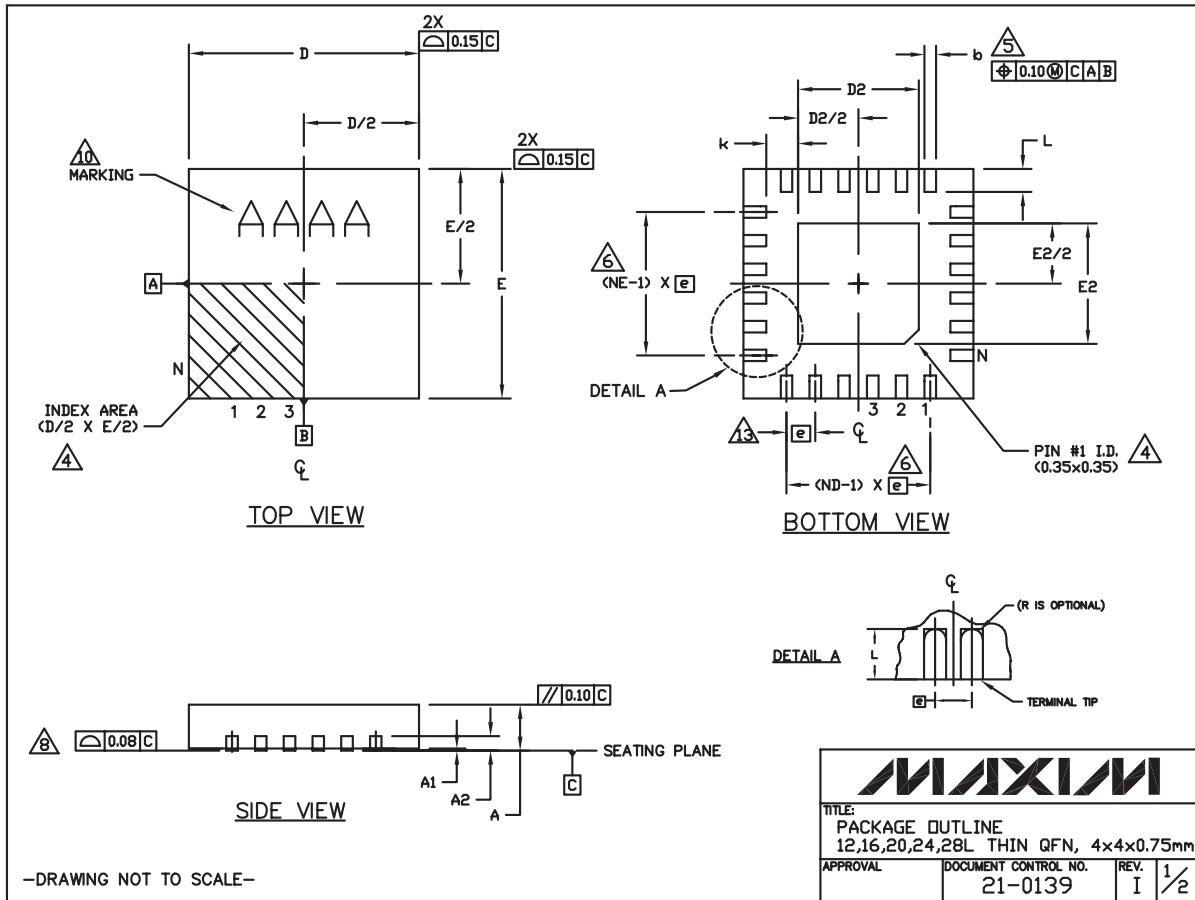

# Mono 7W Class D Amplifier

## Package Information (continued)

For the latest package outline information and land patterns, go to [www.maxim-ic.com/packages](http://www.maxim-ic.com/packages).

MAX9737

COMMON DIMENSIONS															
PKG	12L 4x4			16L 4x4			20L 4x4			24L 4x4			28L 4x4		
REF.	MIN.	NDM.	MAX.	MIN.	NDM.	MAX.	MIN.	NDM.	MAX.	MIN.	NDM.	MAX.	MIN.	NDM.	MAX.
A	0.70	0.75	0.80	0.70	0.75	0.80	0.70	0.75	0.80	0.70	0.75	0.80	0.70	0.75	0.80
A1	0.0	0.02	0.05	0.0	0.02	0.05	0.0	0.02	0.05	0.0	0.02	0.05	0.0	0.02	0.05
A2	0.20 REF			0.20 REF			0.20 REF			0.20 REF			0.20 REF		
b	0.25	0.30	0.35	0.25	0.30	0.35	0.20	0.25	0.30	0.18	0.23	0.30	0.15	0.20	0.25
D	3.90	4.00	4.10	3.90	4.00	4.10	3.90	4.00	4.10	3.90	4.00	4.10	3.90	4.00	4.10
E	3.90	4.00	4.10	3.90	4.00	4.10	3.90	4.00	4.10	3.90	4.00	4.10	3.90	4.00	4.10
e	0.80 BSC.			0.65 BSC.			0.50 BSC.			0.50 BSC.			0.40 BSC.		
k	0.25	-	-	0.25	-	-	0.25	-	-	0.25	-	-	0.25	-	-
L	0.45	0.55	0.65	0.45	0.55	0.65	0.45	0.55	0.65	0.30	0.40	0.50	0.30	0.40	0.50
N	12			16			20			24			28		
ND	3			4			5			6			7		
NE	3			4			5			6			7		
JeDEC Var.	WGGB			WGGC			WGGD-1			WGGD-2			VGGE		

EXPOSED PAD VARIATIONS						
PKG. CODES	D2			E2		
	MIN.	NDM.	MAX.	MIN.	NDM.	MAX.
T1244-3	1.95	2.10	2.25	1.95	2.10	2.25
T1244-4	1.95	2.10	2.25	1.95	2.10	2.25
T1644-3	1.95	2.10	2.25	1.95	2.10	2.25
T1644-4	1.95	2.10	2.25	1.95	2.10	2.25
T2044-2	1.95	2.10	2.25	1.95	2.10	2.25
T2044-3	1.95	2.10	2.25	1.95	2.10	2.25
T2444-2	1.95	2.10	2.25	1.95	2.10	2.25
T2444-3	2.45	2.60	2.63	2.45	2.60	2.63
T2444-4	2.45	2.60	2.63	2.45	2.60	2.63
T2444M-4	2.45	2.60	2.63	2.45	2.60	2.63
T2444M-1	2.45	2.60	2.63	2.45	2.60	2.63
T2844-1	2.50	2.60	2.70	2.50	2.60	2.70

NOTES:

- DIMENSIONING & TOLERANCING CONFORM TO ASME Y14.5M-1994.
- ALL DIMENSIONS ARE IN MILLIMETERS. ANGLES ARE IN DEGREES.
- N IS THE TOTAL NUMBER OF TERMINALS.
- THE TERMINAL #1 IDENTIFIER AND TERMINAL NUMBERING CONVENTION SHALL CONFORM TO JESD 95-1 SPP-012. DETAILS OF TERMINAL #1 IDENTIFIER ARE OPTIONAL, BUT MUST BE LOCATED WITHIN THE ZONE INDICATED. THE TERMINAL #1 IDENTIFIER MAY BE EITHER A MOLD OR MARKED FEATURE.
- DIMENSION b APPLIES TO METALLIZED TERMINAL AND IS MEASURED BETWEEN 0.25mm AND 0.30mm FROM TERMINAL TIP.
- ND AND NE REFER TO THE NUMBER OF TERMINALS ON EACH D AND E SIDE RESPECTIVELY.
- DEPOPULATION IS POSSIBLE IN A SYMMETRICAL FASHION.
- COPLANARITY APPLIES TO THE EXPOSED HEAT SINK SLUG AS WELL AS THE TERMINALS.
- DRAWING CONFORMS TO JEDEC MO220, EXCEPT FOR T2444-3, T2444-4 AND T2844-1.
- MARKING IS FOR PACKAGE ORIENTATION REFERENCE ONLY.
- COPLANARITY SHALL NOT EXCEED 0.08mm.
- WARPAGE SHALL NOT EXCEED 0.10mm.
- LEAD CENTERLINES TO BE AT TRUE POSITION AS DEFINED BY BASIC DIMENSION 'e', ±0.05.
- NUMBER OF LEADS SHOWN ARE FOR REFERENCE ONLY.
- ALL DIMENSIONS ARE THE SAME FOR LEADED (-) & PbFREE (+) PACKAGE CODES.

		
TITLE: PACKAGE OUTLINE 12,16,20,24,28L THIN QFN, 4x4x0.75mm		
APPROVAL	DOCUMENT CONTROL NO. 21-0139	REV. I 2/2

-DRAWING NOT TO SCALE-

Maxim cannot assume responsibility for use of any circuitry other than circuitry entirely embodied in a Maxim product. No circuit patent licenses are implied. Maxim reserves the right to change the circuitry and specifications without notice at any time.

Maxim Integrated Products, 120 San Gabriel Drive, Sunnyvale, CA 94086 408-737-7600 13