

LM48411 Boomer[®] Audio Power Amplifier Series

Ultra-Low EMI, Filterless, 2.5W, Stereo, Class D Audio Power Amplifier with E²S

General Description

The LM48411 is a single supply, high efficiency, 2.5W/channel Class D audio amplifier. The LM48411 features National's Enhanced Emissions Suppression (E²S) system, that features a unique patent-pending ultra low EMI, spread spectrum, PWM architecture, that significantly reduces RF emissions while preserving audio quality and efficiency. The E²S system improves battery life, reduces external component count, board area consumption, system cost, and simplifying design.

The LM48411 is designed to meet the demands of mobile phones and other portable communication devices. Operating on a single 5V supply, it is capable of delivering 2.5W/channel of continuous output power to a 4Ω load with less than 10% THD+N. Its flexible power supply requirements allow operation from 2.4V to 5.5V. The wide band spread spectrum architecture of the LM48411 reduces EMI-radiated emissions due to the modulator frequency.

The LM48411 features high efficiency compared to a conventional Class AB amplifier. The E²S system includes an advanced, patent-pending edge rate control (ERC) architecture that further reduce emissions by minimizing the high frequency component of the device output, while maintaining high quality audio reproduction and high efficiency ($\eta = 87\%$ at $V_{DD} = 3.6V$, $P_O = 500mW$). Four gain options are pin selectable through GAIN0 and GAIN1 pins.

The LM48411 features a low-power consumption shutdown mode. Shutdown may be enabled by driving the Shutdown pin to a logic low (GND).

Output short circuit protection prevents the device from being damaged during fault conditions. Superior click and pop suppression eliminates audible transients on power up/down and during shutdown. Independent left/right shutdown control maximizes power savings in mixed mono/stereo applications.

Key Specifications

■ Efficiency at 3.6V, 500mW into 8Ω speaker	87% (typ)
■ Efficiency at 3.6V, 100mW into 8Ω speaker	80% (typ)
■ Efficiency at 5V, 1W into 8Ω speaker	88% (typ)
■ Quiescent current, 3.6V supply	4.2mA (typ)
■ Power Output at $V_{DD} = 5V$ $R_L = 4\Omega$, THD $\leq 10\%$	2.5W (typ)
■ Power Output at $V_{DD} = 5V$ $R_L = 8\Omega$, THD $\leq 10\%$	1.5W (typ)
■ Total shutdown power supply current	0.01μA (typ)
■ Single supply range	2.4V to 5.5V

Features

- E²S system reduces EMI preserving Audio Quality and Efficiency
- Output short circuit protection
- Stereo Class D Operation
- No output filter required for inductive loads
- Logic selectable gain
- Independent shutdown control
- Minimum external components
- "Click and pop" suppression circuitry
- Micro-power shutdown mode
- Available in space-saving 0.5mm pitch micro SMD package

Applications

- Mobile phones
- PDAs
- Portable electronic devices

LM48411 RF Emissions

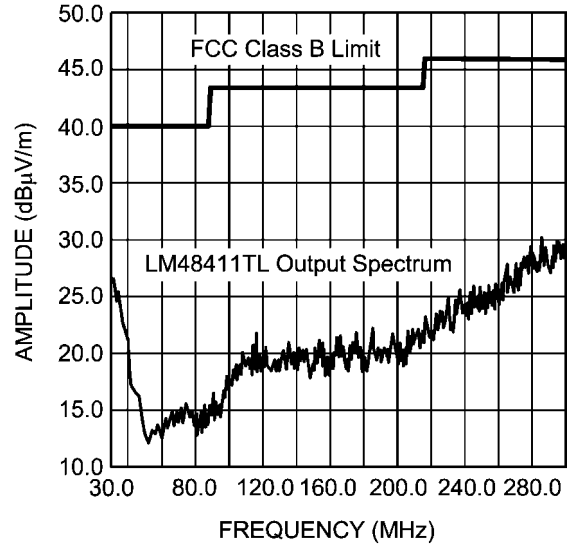

30009586

FIGURE 1. RF Emissions — 3in cable

Typical Application

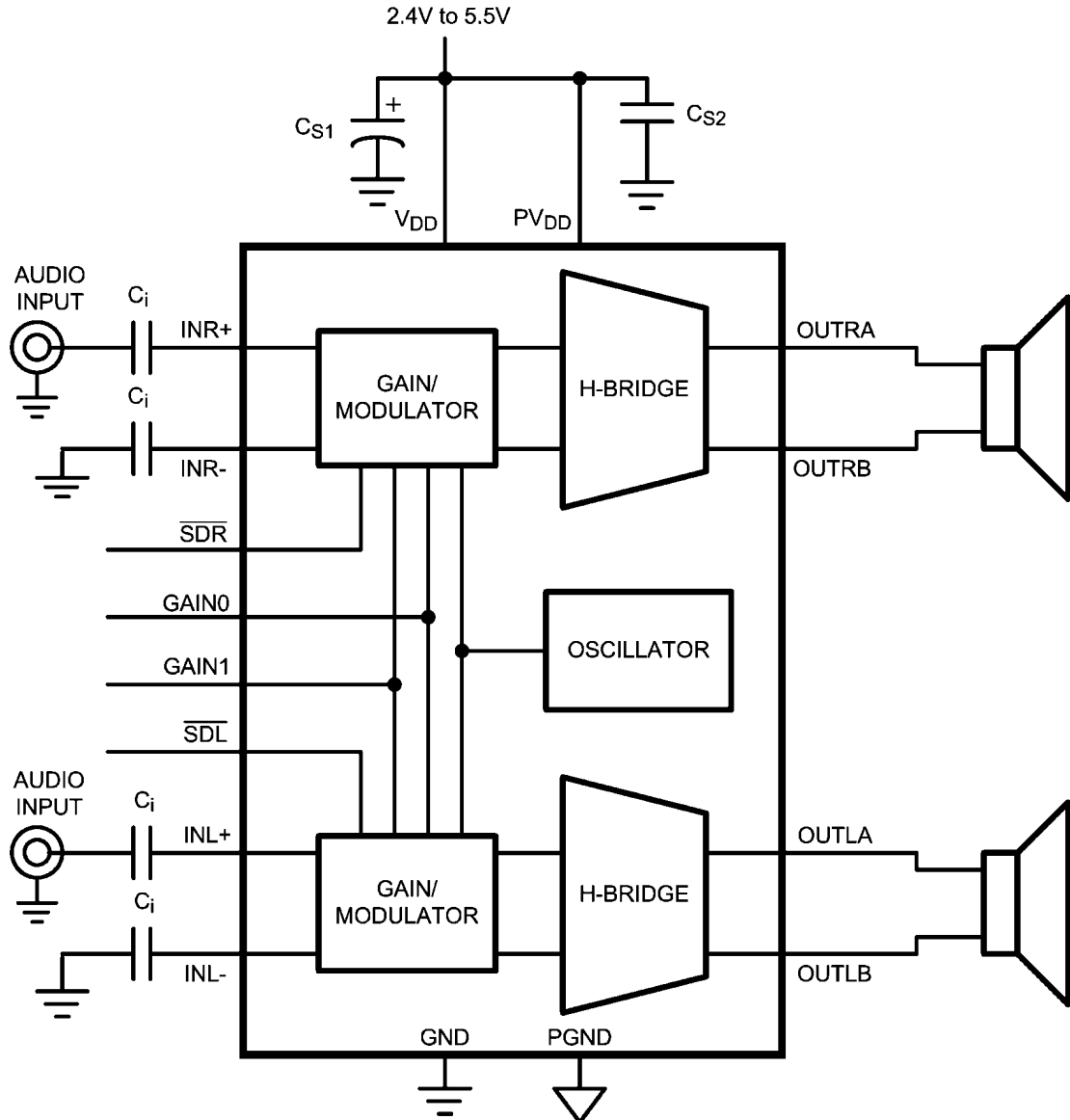

30009501

FIGURE 2. Typical Audio Amplifier Application Circuit

Connection Diagrams

16 Bump micro SMD Package

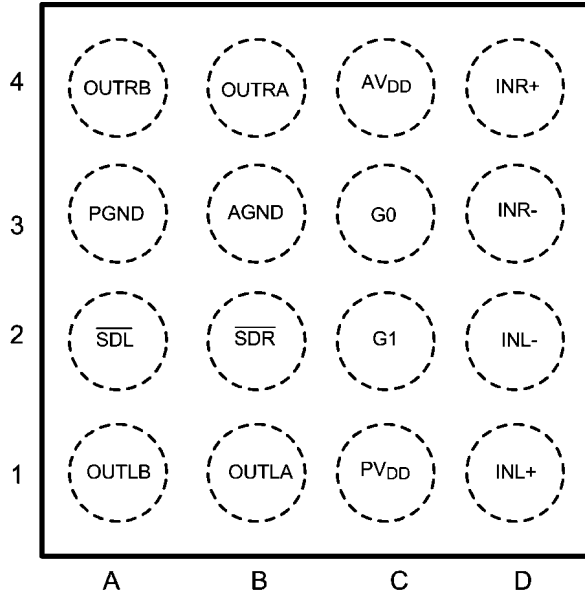

Top View
Order Number LM48411TL
See NS Package Number TLA16ACA

30009502

micro SMD Marking

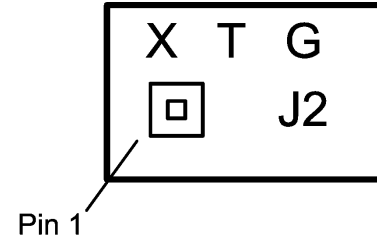

Top View
X — Date Code
T — Die Traceability
G — Boomer Family
J2 — LM48411TL

30009557

Pin Descriptions

Bump	Name	Function
A1	OUTLB	Left Channel output B
A2	$\overline{\text{SDL}}$	Left channel active low shutdown
A3	PGND	Power GND
A4	OUTRB	Right channel output B
B1	OUTLA	Left channel output A
B2	$\overline{\text{SDR}}$	Right channel active low shutdown
B3	AGND	Ground
B4	OUTRA	Right channel output A
C1	PV _{DD}	Power V _{DD}
C2	G1	Gain setting input 1
C3	G0	Gain setting input 0
C4	AV _{DD}	Power supply
D1	INL+	Non-inverting left channel input
D2	INL-	Inverting left channel input
D3	INR-	Inverting right channel input
D4	INR+	Non-inverting right channel input

Absolute Maximum Ratings (Notes 1, 2)

If Military/Aerospace specified devices are required, please contact the National Semiconductor Sales Office/Distributors for availability and specifications.

Supply Voltage (Note 1)	6.0V
Storage Temperature	-65°C to +150°C
Voltage at Any Input Pin	$V_{DD} + 0.3V \geq V \geq GND - 0.3V$
Power Dissipation (Note 3)	Internally Limited
ESD Rating, all other pins (Note 4)	2.0kV
ESD Rating (Note 5)	200V
Junction Temperature (T_{JMAX})	150°C

Thermal Resistance

 θ_{JA} (micro SMD)

63.6°C/W

Soldering Information

See AN-1112 "microSMD Wafers Level Chip Scale Package."

Operating Ratings (Notes 1, 2)

Temperature Range

 $T_{MIN} \leq T_A \leq T_{MAX}$ $-40^\circ\text{C} \leq T_A \leq 85^\circ\text{C}$

Supply Voltage

 $2.4V \leq V_{DD} \leq 5.5V$

Electrical Characteristics The following specifications apply for $A_V = 6\text{dB}$, $R_L = 15\mu\text{H} + 8\Omega$, $f = 1\text{kHz}$, unless otherwise specified. Limits apply for $T_A = 25^\circ\text{C}$. $V_{DD} = 3.6V$.

Symbol	Parameter	Conditions	LM48411		Units (Limits)
			Typical	Limit	
			(Note 6)	(Notes 7, 8)	
I_{VOS}	Differential Output Offset Voltage	$V_I = 0V$, $A_V = 2V/V$, $V_{DD} = 2.4V$ to $5.0V$	5		mV
I_{DD}	Quiescent Power Supply Current	$V_{IN} = 0V$, No Load, $V_{DD} = 5.0V$	5.1	7.5	mA (max)
		$V_{IN} = 0V$, No Load, $V_{DD} = 3.6V$	4.2	6.0	mA (max)
		$V_{IN} = 0V$, No Load, $V_{DD} = 2.4V$	3.0	4.5	mA (max)
		$V_{IN} = 0V$, $R_L = 8\Omega$, $V_{DD} = 5.0V$	5.2		mA
		$V_{IN} = 0V$, $R_L = 8\Omega$, $V_{DD} = 3.6V$	4.2		mA
		$V_{IN} = 0V$, $R_L = 8\Omega$, $V_{DD} = 2.4V$	3.0		mA
I_{SD}	Shutdown Current	$V_{SDR} = V_{SDL} = GND$	0.01	1.0	μA (max)
V_{SDIH}	Shutdown voltage input high	For SDR, SDL		1.4	V (min)
V_{SDIL}	Shutdown voltage input low	For SDR, SDL		0.4	V (max)
A_V	Gain	$GAIN0, GAIN1 = GND$ $R_L = \infty$	6	6 ± 0.5	dB
		$GAIN0 = V_{DD}$, $GAIN1 = GND$ $R_L = \infty$	12	12 ± 0.5	dB
		$GAIN0 = GND$, $GAIN1 = V_{DD}$ $R_L = \infty$	18	18 ± 0.5	dB
		$GAIN0, GAIN1 = V_{DD}$ $R_L = \infty$	24	24 ± 0.5	dB
R_{IN}	Input Resistance	$A_V = 6\text{dB}$	56		$\text{k}\Omega$
		$A_V = 12\text{dB}$	37.5		$\text{k}\Omega$
		$A_V = 18\text{dB}$	22.5		$\text{k}\Omega$
		$A_V = 24\text{dB}$	12.5		$\text{k}\Omega$
T_{WU}	Wake Up Time	$V_{SDR/SDL} = 0.4V$	4.2		ms

Symbol	Parameter	Conditions	LM48411		Units (Limits)
			Typical	Limit	
			(Note 6)	(Notes 7, 8)	
P _O	Output Power	R _L = 15μH + 4Ω + 15μH THD = 10% (max) f = 1kHz, 22kHz BW V _{DD} = 5V V _{DD} = 3.6V V _{DD} = 2.5V	2.5 1.2 530		W W mW
		R _L = 15μH + 4Ω + 15μH THD = 1% (max) f = 1kHz, 22kHz BW V _{DD} = 5V V _{DD} = 3.6V V _{DD} = 2.5V	2.0 1.0 430		W W mW
P _O	Output Power	R _L = 15μH + 8Ω + 15μH THD = 10% (max) f = 1kHz, 22kHz BW			
		V _{DD} = 5V	1.5		W
		V _{DD} = 3.6V	760	600	mW (min)
		V _{DD} = 2.5V	330		mW
		R _L = 15μH + 8Ω + 15μH THD = 1% (max) f = 1kHz, 22kHz BW			
		V _{DD} = 5V	1.25		W
		V _{DD} = 3.6V	615		mW
V _{DD} = 2.5V	270		mW		
THD+N	Total Harmonic Distortion + Noise	P _O = 500mW, f = 1kHz, R _L = 8Ω	0.05		%
		P _O = 300mW, f = 1kHz, R _L = 8Ω	0.03		%
PSRR	Power Supply Rejection Ratio (Input Referred)	V _{Ripple} = 200mV _{PP} Sine, f _{Ripple} = 217Hz, V _{DD} = 3.6, 5V Inputs to AC GND, C ₁ = 2μF	78		dB
		V _{Ripple} = 200mV _{PP} Sine, f _{Ripple} = 1kHz, V _{DD} = 3.6, 5V Inputs to AC GND, C ₁ = 2μF	77		dB
SNR	Signal to Noise Ratio	V _{DD} = 5V, P _O = 1W _{RMS}	96		dB
ε _{OUT}	Output Noise (Input Referred)	V _{DD} = 3.6V, A Weighted	22		μV _{RMS}
CMRR	Common Mode Rejection Ratio (Input Referred)	V _{DD} = 3.6V, V _{Ripple} = 1V _{PP} Sine f _{Ripple} = 217Hz	64		dB
η	Efficiency	V _{DD} = 5V, P _{OUT} = 1W R _L = 8Ω	88		%
Xtalk	Crosstalk	P _O = 500mW, f = kHz	84		dB

Note 1: "Absolute Maximum Ratings" indicate limits beyond which damage to the device may occur, including inoperability and degradation of device reliability and/or performance. Functional operation of the device and/or non-degradation at the Absolute Maximum Ratings or other conditions beyond those indicated in the Recommended Operating Conditions is not implied. The Recommended Operating Conditions indicate conditions at which the device is functional and the device should not be operated beyond such conditions. All voltages are measured with respect to the ground pin, unless otherwise specified

Note 2: The Electrical Characteristics tables list guaranteed specifications under the listed Recommended Operating Conditions except as otherwise modified or specified by the Electrical Characteristics Conditions and/or Notes. Typical specifications are estimations only and are not guaranteed.

Note 3: The maximum power dissipation must be derated at elevated temperatures and is dictated by T_{JMAX} , θ_{JA} , and the ambient temperature, T_A . The maximum allowable power dissipation is $P_{DMAX} = (T_{JMAX} - T_A) / \theta_{JA}$ or the number given in Absolute Maximum Ratings, whichever is lower. For the LMxxxx, see Power Derating curves for additional information.

Note 4: Human body model, applicable std. JESD22-A114C.

Note 5: Machine model, applicable std. JESD22-A115-A.

Note 6: Typical values represent most likely parametric norms at $T_A = +25^\circ\text{C}$, and at the Recommended Operation Conditions at the time of product characterization and are not guaranteed.

Note 7: Datasheet min/max specification limits are guaranteed by test or statistical analysis.

Note 8: Shutdown current is measured in a normal room environment. Exposure to direct sunlight will increase I_{SD} by a maximum of $2\mu\text{A}$. The Shutdown pin should be driven as close as possible to GND for minimal shutdown current and to V_{DD} for the best THD performance in PLAY mode. See the Application Information section under SHUTDOWN FUNCTION for more information.

Note 9: The performance graphs were taken using the Audio Precision AUX-0025 Switching Amplifier measurement Filter in series with the LC filter on the demo board.

Typical Performance Characteristics

THD+N vs Frequency
 $V_{DD} = 2.5\text{V}$, $R_L = 8\Omega$, $P_O = 100\text{mW/channel}$
 $A_V = 6\text{dB}$

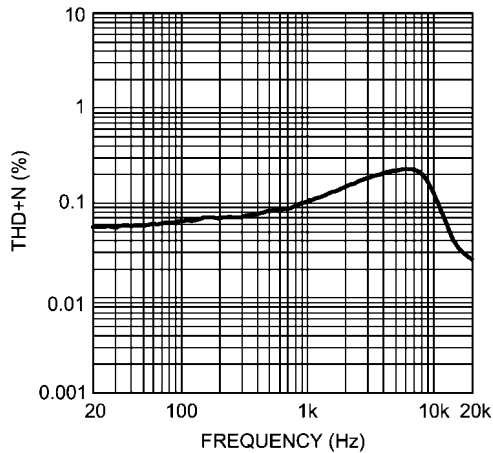

30009540

THD+N vs Frequency
 $V_{DD} = 3.6\text{V}$, $R_L = 8\Omega$, $P_O = 250\text{mW/channel}$
 $A_V = 6\text{dB}$

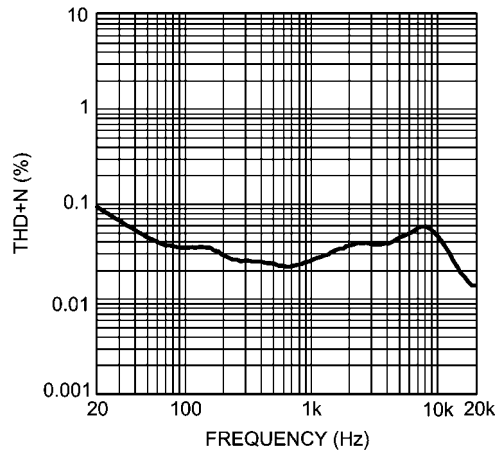

30009546

THD+N vs Frequency
 $V_{DD} = 5.0\text{V}$, $R_L = 8\Omega$, $P_O = 375\text{mW/channel}$
 $A_V = 6\text{dB}$

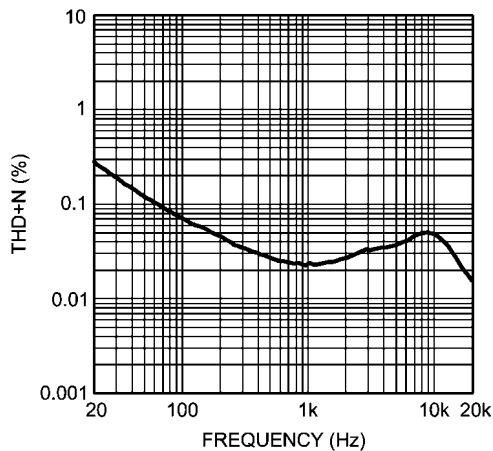

30009549

THD+N vs Frequency
 $V_{DD} = 2.5\text{V}$, $R_L = 4\Omega$, $P_O = 100\text{mW/channel}$
 $A_V = 6\text{dB}$

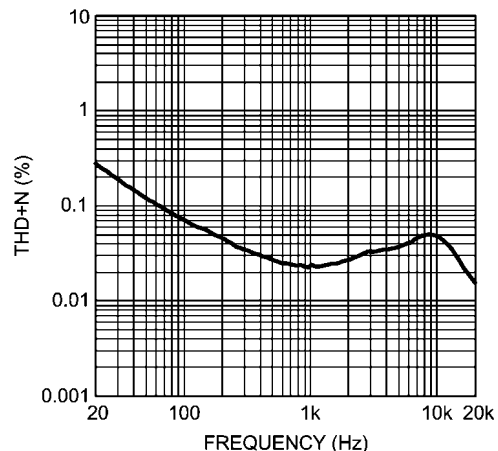

30009552

THD+N vs Frequency
 $V_{DD} = 3.6V, R_L = 4\Omega, P_O = 250mW/channel$
 $A_V = 6dB$

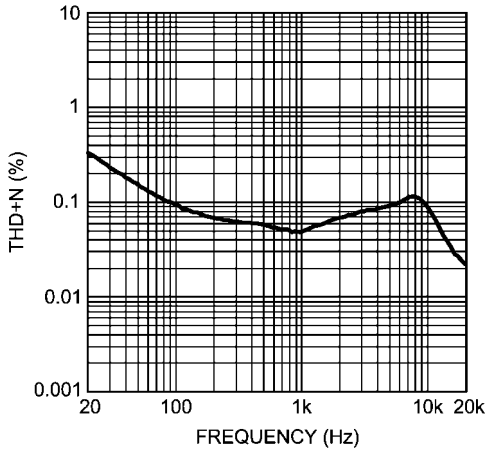

30009556

THD+N vs Frequency
 $V_{DD} = 5.0V, R_L = 4\Omega, P_O = 375mW/channel$
 $A_V = 6dB$

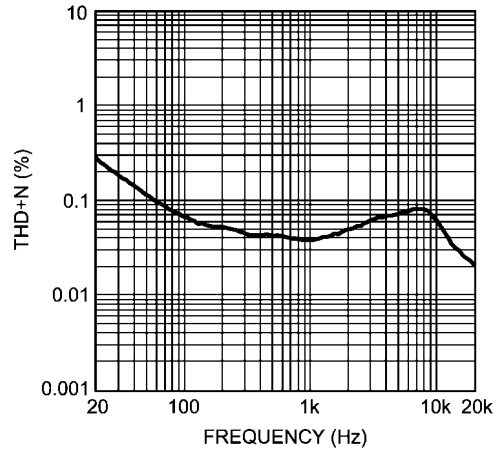

30009558

THD+N vs Output Power
 $V_{DD} = 2.5V, R_L = 8\Omega, A_V = 6dB$

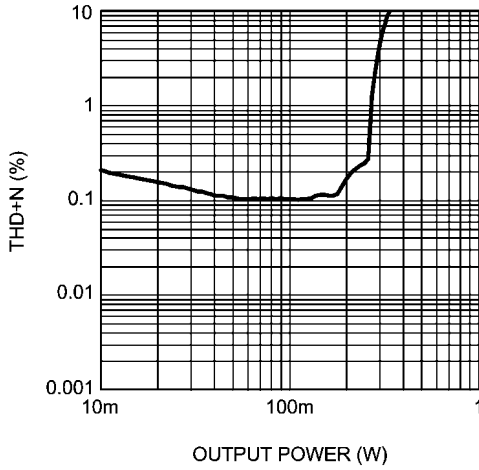

30009574

THD+N vs Output Power
 $V_{DD} = 2.5V, R_L = 8\Omega, A_V = 24dB$

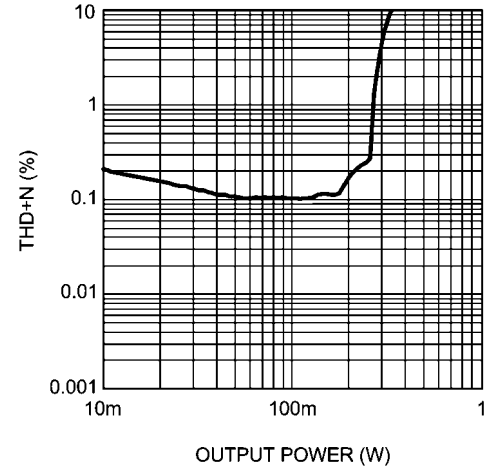

30009575

THD+N vs Output Power
 $V_{DD} = 3.6V, R_L = 8\Omega, A_V = 6dB$

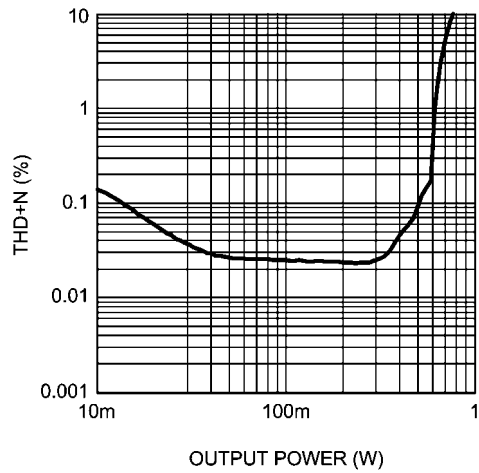

30009578

THD+N vs Output Power
 $V_{DD} = 3.6V, R_L = 8\Omega, A_V = 24dB$

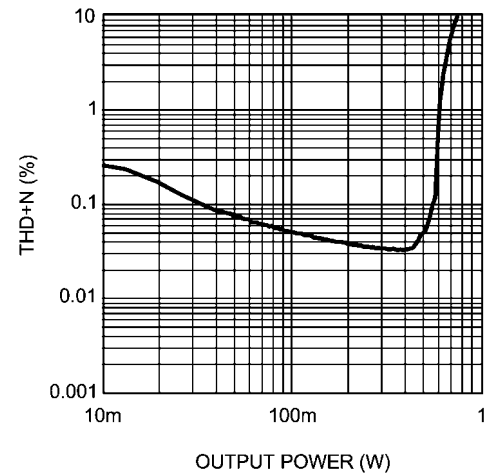

30009579

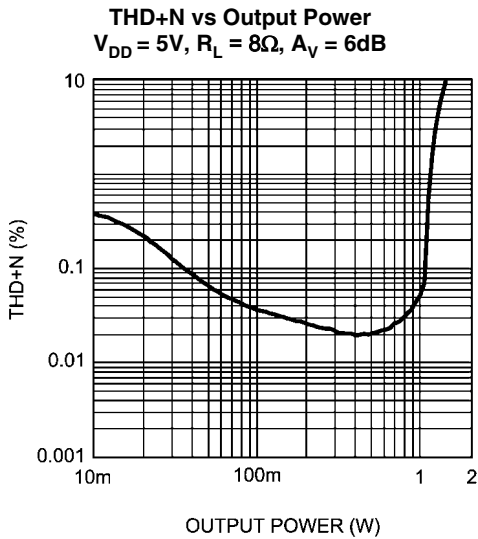

30009582

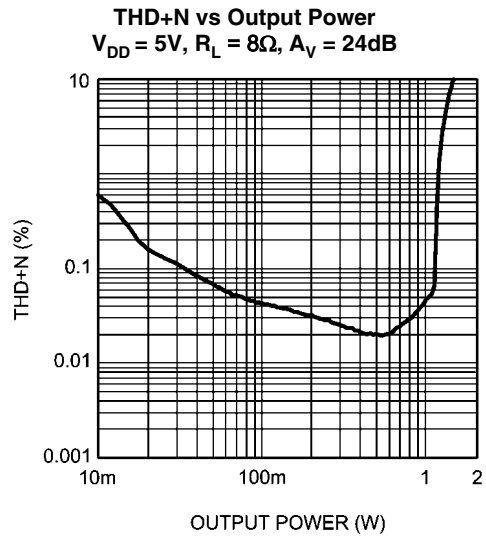

30009583

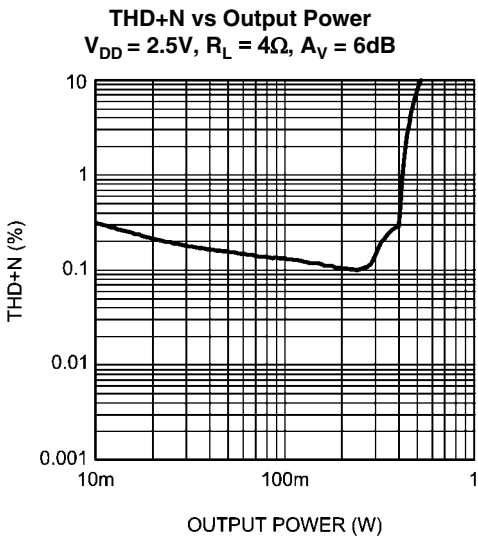

30009572

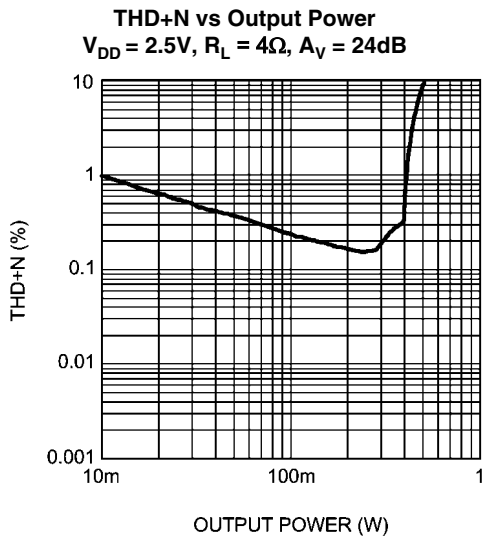

30009573

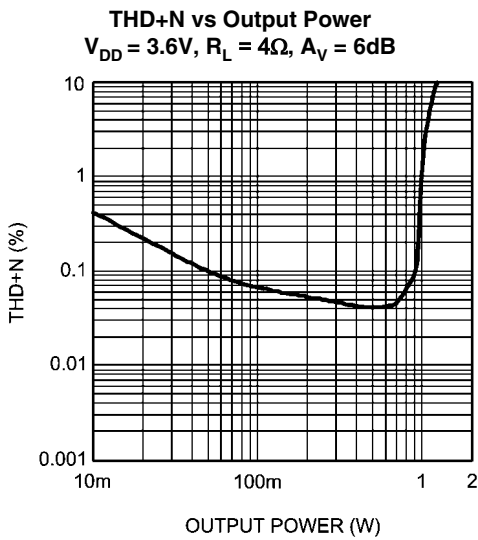

30009576

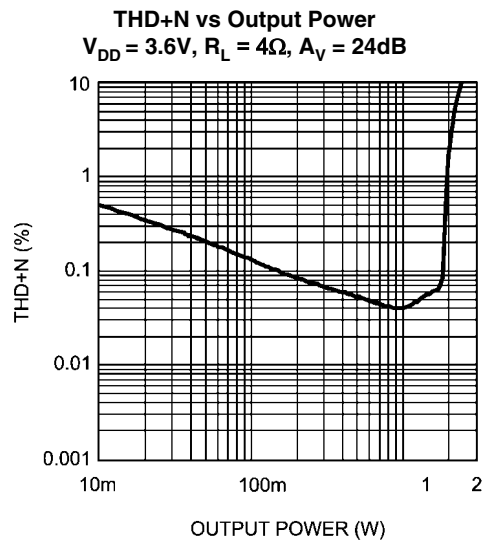

30009577

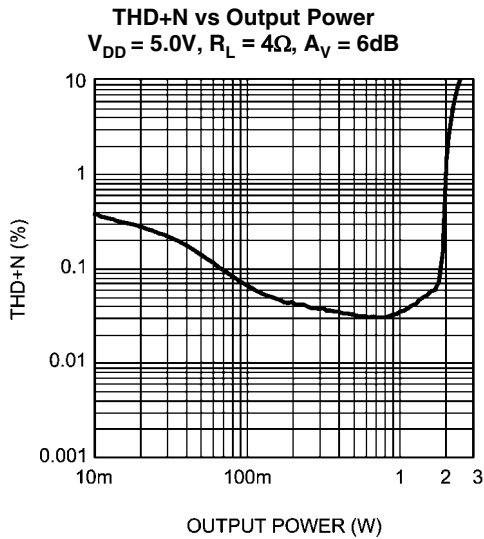

30009580

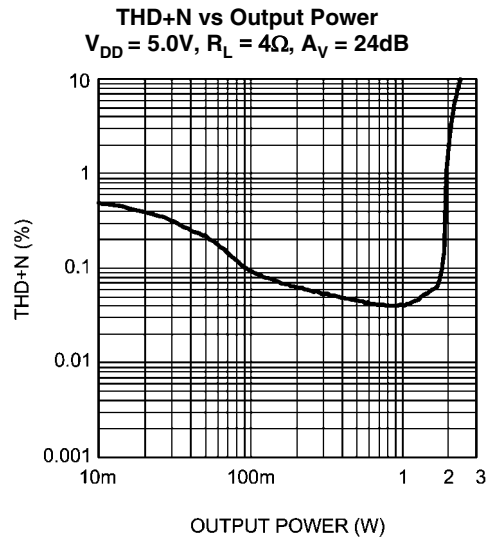

30009581

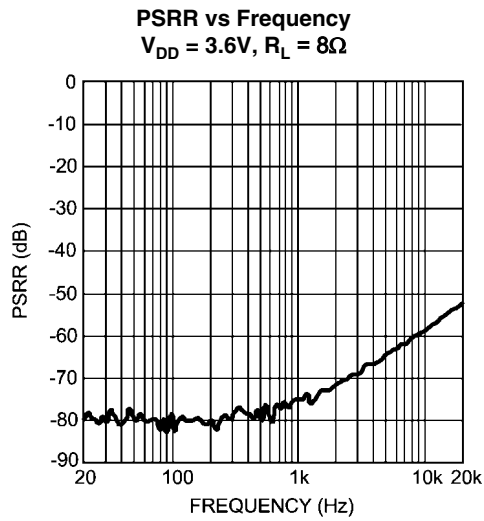

30009568

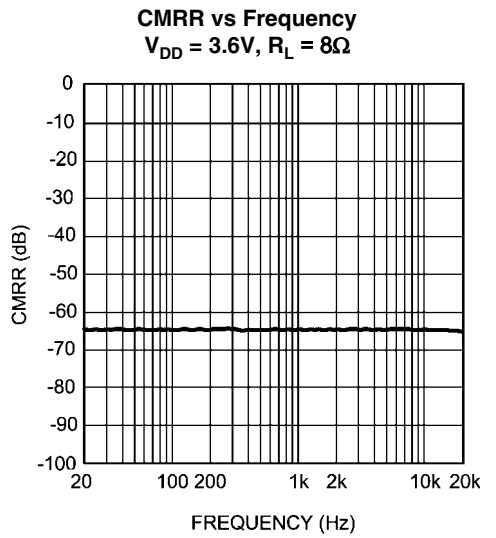

30009571

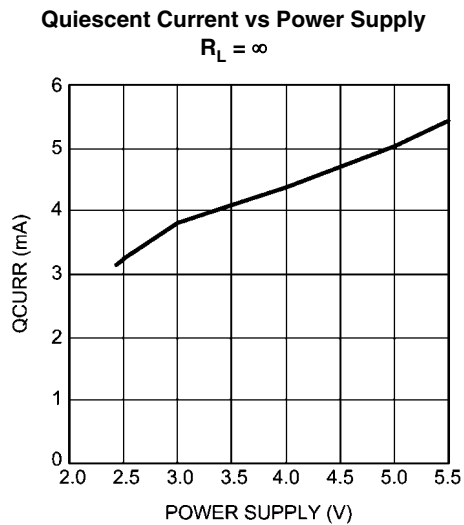

30009542

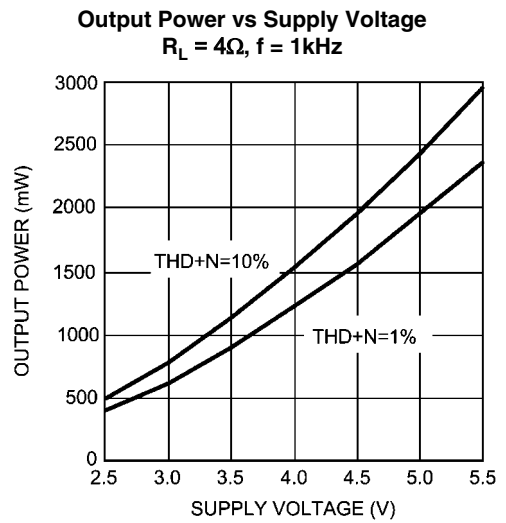

30009561

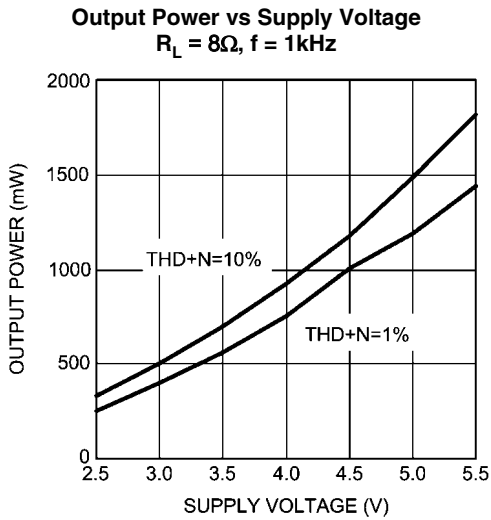

30009562

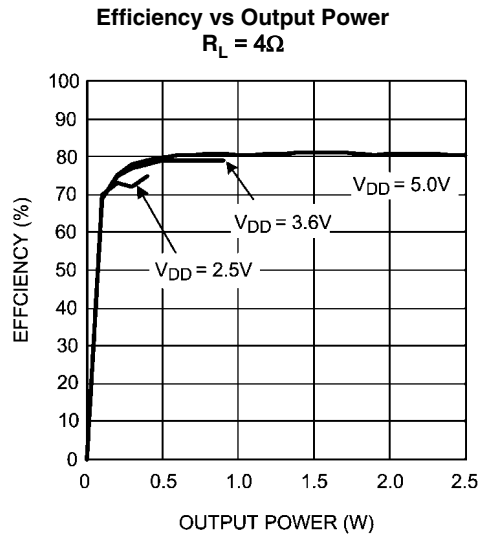

30009569

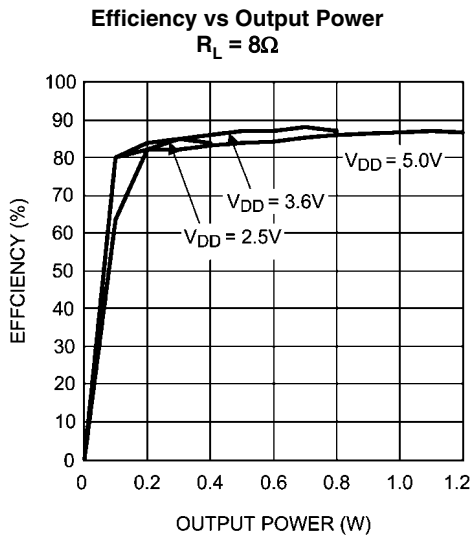

30009570

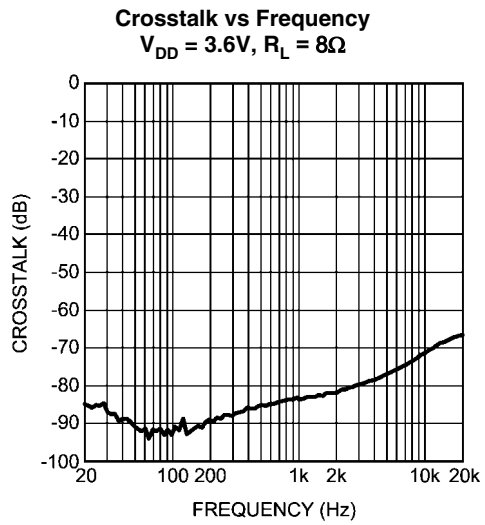

30009563

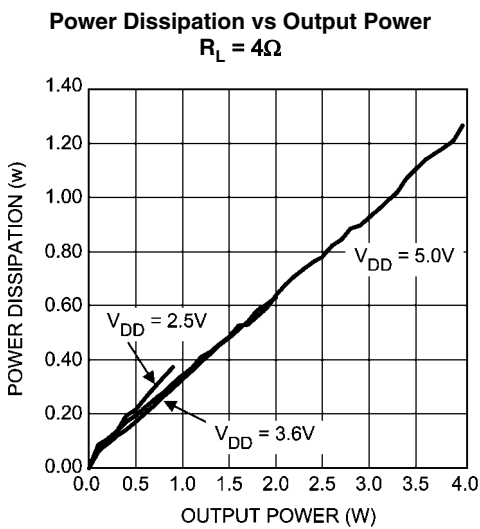

30009566

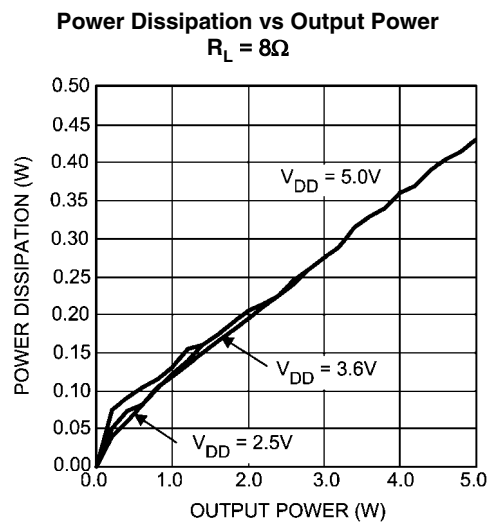

30009567

External Components Description

(Figure 2)

Components		Functional Description
1.	C_S	Supply bypass capacitor which provides power supply filtering. Refer to the Power Supply Bypassing section for information concerning proper placement and selection of the supply bypass capacitor.
2.	C_I	Input AC coupling capacitor which blocks the DC voltage at the amplifier's input terminals.

Application Information

GENERAL AMPLIFIER FUNCTION

The LM48411 features a filterless modulation scheme. The differential outputs of the device switch at 300kHz from V_{DD} to GND. When there is no input signal applied, the two outputs (V_{O1} and V_{O2}) switch with a 50% duty cycle, with both outputs in phase. Because the outputs of the LM48411 are differential, the two signals cancel each other. This results in no net voltage across the speaker, thus there is no load current during an idle state, conserving power.

With an input signal applied, the duty cycle (pulse width) of the LM48411 outputs changes. For increasing output voltages, the duty cycle of V_{O1} increases, while the duty cycle of V_{O2} decreases. For decreasing output voltages, the converse occurs, the duty cycle of V_{O2} increases while the duty cycle of V_{O1} decreases. The difference between the two pulse widths yields the differential output voltage.

SPREAD SPECTRUM MODULATION

The LM48411 features a filterless spread spectrum modulation scheme that eliminates the need for output filters, ferrite beads or chokes. The switching frequency varies by $\pm 30\%$ about a 300kHz center frequency, reducing the wideband spectral content, improving EMI emissions radiated by the speaker and associated cables and traces. Where a fixed frequency class D exhibits large amounts of spectral energy at multiples of the switching frequency, the spread spectrum architecture of the LM48411 spreads that energy over a larger bandwidth. The cycle-to-cycle variation of the switching period does not affect the audio reproduction of efficiency.

ENHANCED EMISSIONS SUPPRESSION SYSTEM (E²S)

The LM48411 features National's patent-pending E²S system that reduces EMI, while maintaining high quality audio reproduction and efficiency. The E²S system features a synchronizable oscillator with selectable spread spectrum, and advanced edge rate control (ERC). The LM48411 ERC greatly reduces the high frequency components of the output square waves by controlling the output rise and fall times, slowing the transitions to reduce RF emissions, while maximizing THD+N and efficiency performance.

POWER DISSIPATION AND EFFICIENCY

In general terms, efficiency is considered to be the ratio of useful work output divided by the total energy required to produce it with the difference being the power dissipated, typically, in the IC. The key here is "useful" work. For audio systems, the energy delivered in the audible bands is considered useful including the distortion products of the input signal. Sub-sonic (DC) and super-sonic components (>22kHz) are not useful. The difference between the power flowing from the power supply and the audio band power being transduced is dissipated in the LM48411 and in the transducer load. The amount of power dissipation in the LM48411 is very low. This is because the ON resistance of the switches used to form the output waveforms is typically less than 0.25Ω . This leaves only the transducer load as a potential "sink" for the small excess of input power over audio band output power. The LM48411 dissipates only a fraction of the excess power requiring no additional PCB area or copper plane to act as a heat sink.

DIFFERENTIAL AMPLIFIER EXPLANATION

As logic supply voltages continue to shrink, designers are increasingly turning to differential analog signal handling to preserve signal to noise ratios with restricted voltage swing. The LM48411 is a fully differential amplifier that features differential input and output stages. A differential amplifier amplifies the difference between the two input signals. Traditional audio power amplifiers have typically offered only single-ended inputs resulting in a 6dB reduction in signal to noise ratio relative to differential inputs. The LM48411 also offers the possibility of DC input coupling which eliminates the two external AC coupling, DC blocking capacitors. The LM48411 can be used, however, as a single ended input amplifier while still retaining its fully differential benefits. In fact, completely unrelated signals may be placed on the input pins. The LM48411 simply amplifies the difference between the signals. A major benefit of a differential amplifier is the improved common mode rejection ratio (CMRR) over single input amplifiers. The common-mode rejection characteristic of the differential amplifier reduces sensitivity to ground offset related noise injection, especially important in high noise applications.

PCB LAYOUT CONSIDERATIONS

As output power increases, interconnect resistance (PCB traces and wires) between the amplifier, load and power supply create a voltage drop. The voltage loss on the traces between the LM48411 and the load results in lower output power and decreased efficiency. Higher trace resistance between the supply and the LM48411 has the same effect as a poorly regulated supply, increased ripple on the supply line also reducing the peak output power. The effects of residual trace resistance increases as output current increases due to higher output power, decreased load impedance or both. To maintain the highest output voltage swing and corresponding peak output power, the PCB traces that connect the output pins to the load and the supply pins to the power supply should be as wide as possible to minimize trace resistance.

The use of power and ground planes will give the best THD +N performance. While reducing trace resistance, the use of power planes also creates parasite capacitors that help to filter the power supply line.

The inductive nature of the transducer load can also result in overshoot on one or both edges, clamped by the parasitic diodes to GND and V_{DD} in each case. From an EMI standpoint, this is an aggressive waveform that can radiate or conduct to other components in the system and cause interference. It is essential to keep the power and output traces short and well shielded if possible. Use of ground planes, beads, and micro-strip layout techniques are all useful in preventing unwanted interference.

As the distance from the LM48411 and the speaker increase, the amount of EMI radiation will increase since the output wires or traces acting as antenna become more efficient with length. What is acceptable EMI is highly application specific. Ferrite chip inductors placed close to the LM48411 may be needed to reduce EMI radiation. The value of the ferrite chip is very application specific.

SHUTDOWN FUNCTION

In order to reduce power consumption while not in use, the LM48411 contains shutdown circuitry that reduces current draw to less than 0.01µA. The trigger point for shutdown is shown as a typical value in the Electrical Characteristics Tables and in the Shutdown Hysteresis Voltage graphs found in the **Typical Performance Characteristics** section. It is best to switch between ground and supply for minimum current usage while in the shutdown state. While the LM48411 may be disabled with shutdown voltages in between ground and supply, the idle current will be greater than the typical 0.01µA value.

The LM48411 has an internal resistor connected between GND and Shutdown pins. The purpose of this resistor is to eliminate any unwanted state changes when the Shutdown pin is floating. The LM48411 will enter the shutdown state when the Shutdown pin is left floating or if not floating, when the shutdown voltage has crossed the threshold. To minimize the supply current while in the shutdown state, the Shutdown pin should be driven to GND or left floating. If the Shutdown pin is not driven to GND, the amount of additional resistor current due to the internal shutdown resistor can be found by Equation (1) below.

$$(V_{SD} - GND) / 300k\Omega \quad (1)$$

With only a 0.5V difference, an additional 1.7µA of current will be drawn while in the shutdown state.

AUDIO AMPLIFIER POWER SUPPLY BYPASSING FILTERING

Proper power supply bypassing is critical for low noise performance and high PSRR. Place the supply bypass capacitor as close to the device as possible. Typical applications employ a voltage regulator with 10µF and 0.1µF bypass capacitors that increase supply stability. These capacitors do not eliminate the need for bypassing of the LM48411 supply pins. A 1µF capacitor is recommended.

Build of Materials

Designator	Description	Footprint	Quantity
C1, C2	Ceramic Capacitor 0.1µF, 50V, 10%	805	2
C3 – C6	Tantalum Capacitors 1µF 20V, 10%, Size A	1206	4
C11	Tantalum Capacitors 10µF 20V, 10% Size B	1411	1
JP1–5, JP8–11	Jumper Header Vertical Mount 2X1 0.100		9
JP6, JP7	Jumper Header Vertical Mount 3x1 0.100		2

AUDIO AMPLIFIER INPUT CAPACITOR SELECTION

Input capacitors may be required for some applications, or when the audio source is single-ended. Input capacitors block the DC component of the audio signal, eliminating any conflict between the DC component of the audio source and the bias voltage of the LM48411. The input capacitors create a high-pass filter with the input resistance R_i . The -3dB point of the high pass filter is found using Equation 1 below.

$$f = 1 / 2\pi R_i C_i \quad (2)$$

The values for R_i can be found in the EC table for each gain setting.

The input capacitors can also be used to remove low frequency content from the audio signal. Small speakers cannot reproduce, and may even be damaged by low frequencies. High pass filtering the audio signal helps protect the speakers. When the LM48411 is using a single-ended source, power supply noise on the ground is seen as an input signal. Setting the high-pass filter point above the power supply noise frequencies, 217 Hz in a GSM phone, for example, filters out the noise such that it is not amplified and heard on the output. Capacitors with a tolerance of 10% or better are recommended for impedance matching and improved CMRR and PSRR.

AUDIO AMPLIFIER GAIN SETTING

The LM48411 features four internally configured gain settings. The device gain is selected through the two logic inputs, G0 and G1. The gain settings are as shown in the following table.

LOGIC INPUT		GAIN	
G1	G0	V/V	dB
0	0	2	6
0	1	4	12
1	0	8	18
1	1	16	24

Demonstration Board Schematic

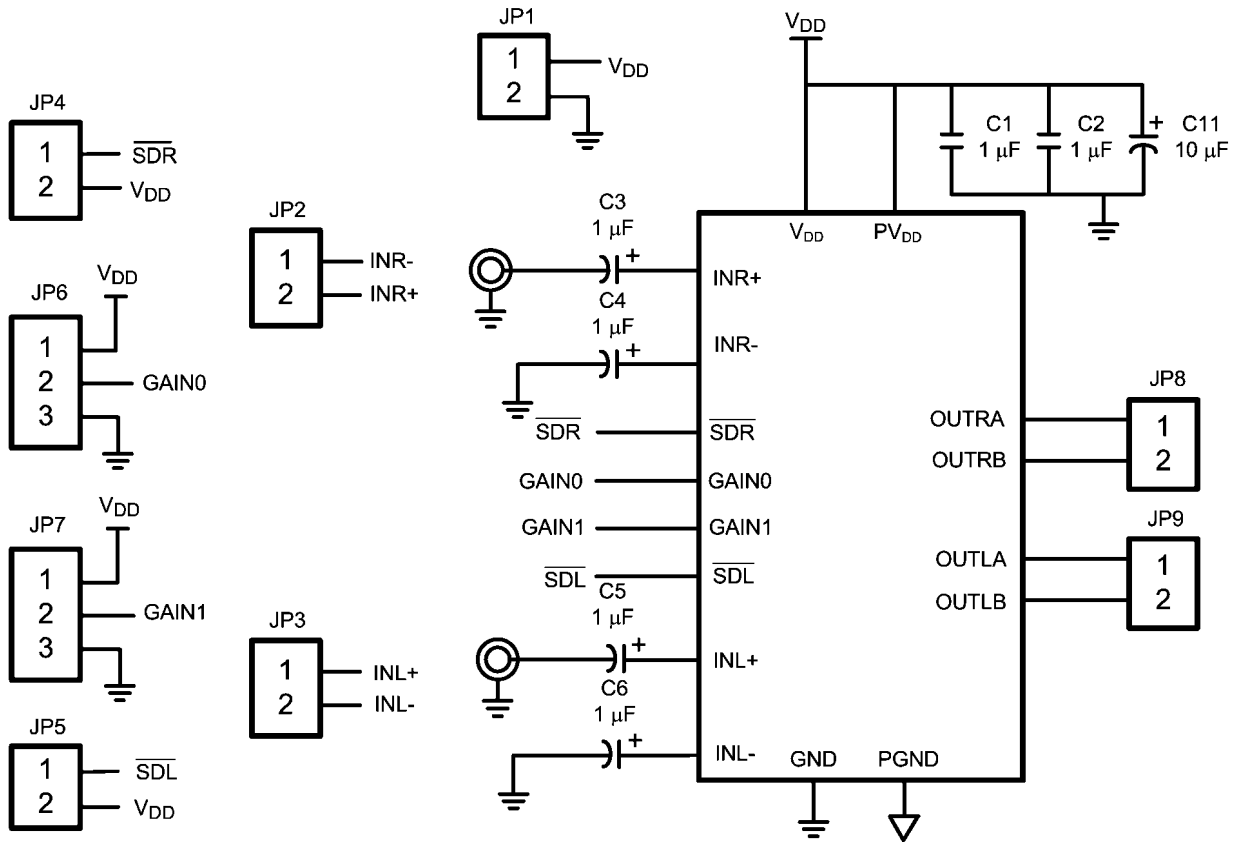

30009592

Demonstration Board Layout

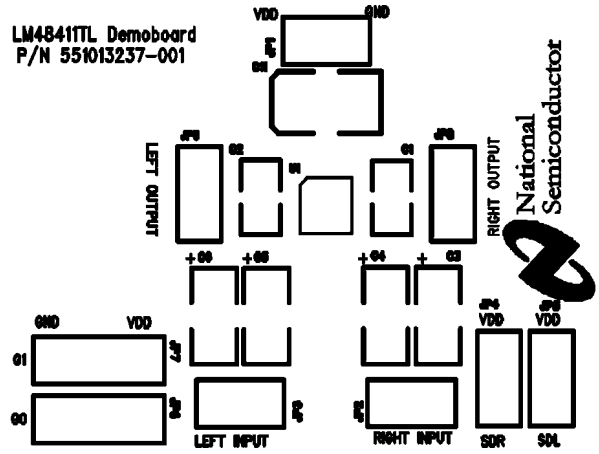

Top Silkscreen Layer

30009591

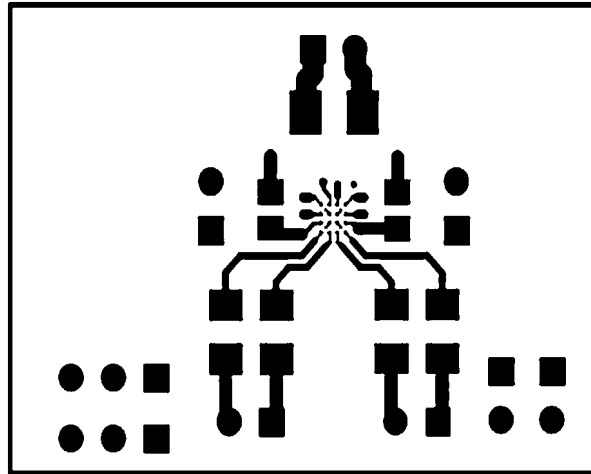

Top Layer

30009590

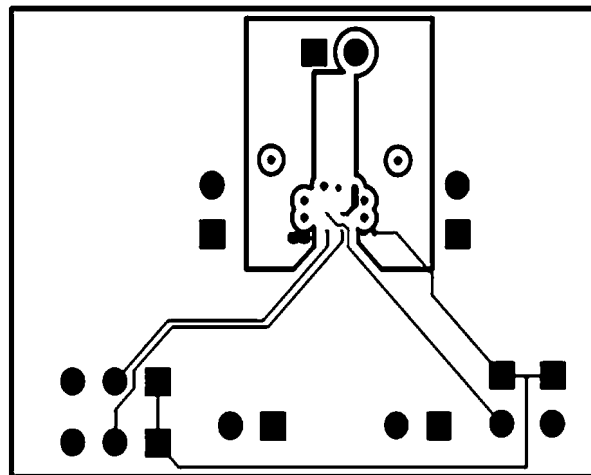

Mid 1 Layer

30009588

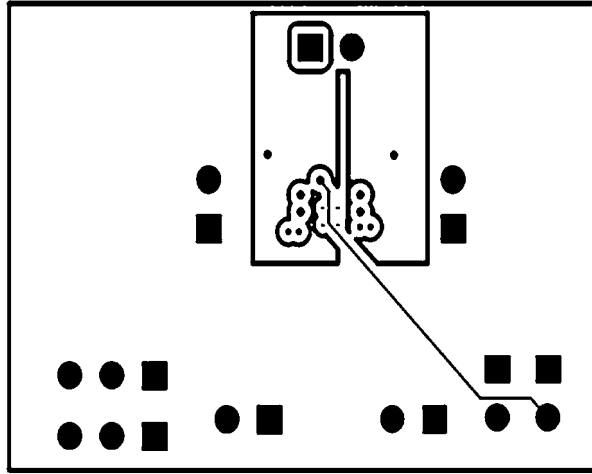

30009589

Mid 2 Layer

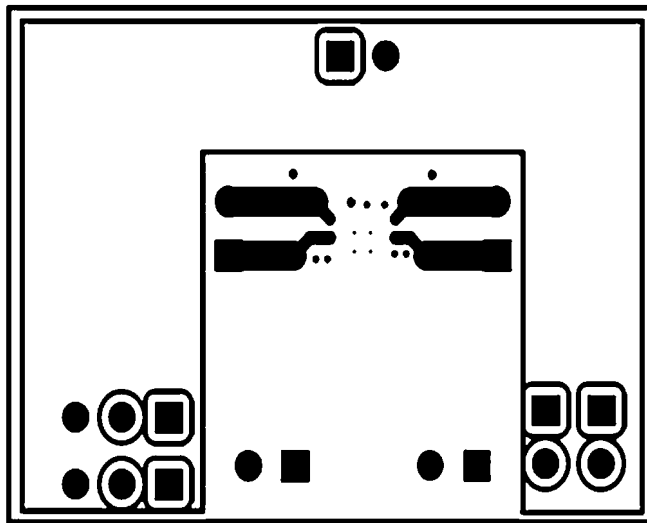

30009587

Bottom Layer

Revision History

Rev	Date	Description
1.0	09/21/07	Initial release.
1.1	10/01/07	Fixed few typos.
1.2	11/30/07	Added the demo boards and BOM.
1.3	12/19/07	Edited the 16–bump micro SMD package diagram and the Pin Description table.
1.4	01/08/08	Edited the 16–bump micro SMD package diagram.
1.5	06/27/08	Text edits.
1.6	07/03/08	Text edits (under SHUTDOWN FUNCTION).

Physical Dimensions inches (millimeters) unless otherwise noted

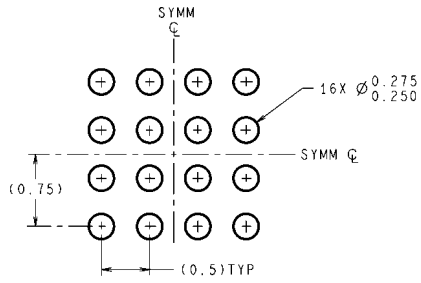

DIMENSIONS ARE IN MILLIMETERS
DIMENSIONS IN () FOR REFERENCE ONLY

LAND PATTERN RECOMMENDATION

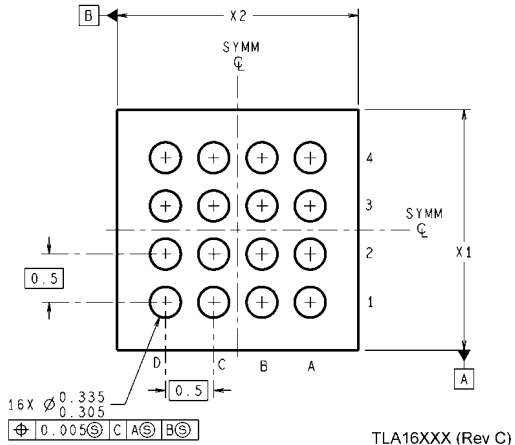
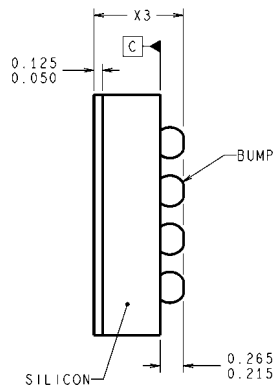
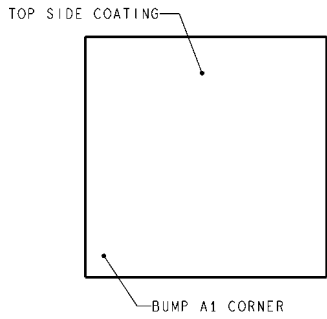

TLA16XXX (Rev C)

16 Bump micro SMD
Order Number LM48411TL
NS Package Number TLA16ACA
X1 = 1.996mm X2 = 2.047mm X3 = 0.6mm

Notes

For more National Semiconductor product information and proven design tools, visit the following Web sites at:

Products		Design Support	
Amplifiers	www.national.com/amplifiers	WEBENCH	www.national.com/webench
Audio	www.national.com/audio	Analog University	www.national.com/AU
Clock Conditioners	www.national.com/timing	App Notes	www.national.com/appnotes
Data Converters	www.national.com/adc	Distributors	www.national.com/contacts
Displays	www.national.com/displays	Green Compliance	www.national.com/quality/green
Ethernet	www.national.com/ethernet	Packaging	www.national.com/packaging
Interface	www.national.com/interface	Quality and Reliability	www.national.com/quality
LVDS	www.national.com/lvds	Reference Designs	www.national.com/refdesigns
Power Management	www.national.com/power	Feedback	www.national.com/feedback
Switching Regulators	www.national.com/switchers		
LDOs	www.national.com/lido		
LED Lighting	www.national.com/led		
PowerWise	www.national.com/powerwise		
Serial Digital Interface (SDI)	www.national.com/sdi		
Temperature Sensors	www.national.com/tempsensors		
Wireless (PLL/VCO)	www.national.com/wireless		

THE CONTENTS OF THIS DOCUMENT ARE PROVIDED IN CONNECTION WITH NATIONAL SEMICONDUCTOR CORPORATION ("NATIONAL") PRODUCTS. NATIONAL MAKES NO REPRESENTATIONS OR WARRANTIES WITH RESPECT TO THE ACCURACY OR COMPLETENESS OF THE CONTENTS OF THIS PUBLICATION AND RESERVES THE RIGHT TO MAKE CHANGES TO SPECIFICATIONS AND PRODUCT DESCRIPTIONS AT ANY TIME WITHOUT NOTICE. NO LICENSE, WHETHER EXPRESS, IMPLIED, ARISING BY ESTOPPEL OR OTHERWISE, TO ANY INTELLECTUAL PROPERTY RIGHTS IS GRANTED BY THIS DOCUMENT.

TESTING AND OTHER QUALITY CONTROLS ARE USED TO THE EXTENT NATIONAL DEEMS NECESSARY TO SUPPORT NATIONAL'S PRODUCT WARRANTY. EXCEPT WHERE MANDATED BY GOVERNMENT REQUIREMENTS, TESTING OF ALL PARAMETERS OF EACH PRODUCT IS NOT NECESSARILY PERFORMED. NATIONAL ASSUMES NO LIABILITY FOR APPLICATIONS ASSISTANCE OR BUYER PRODUCT DESIGN. BUYERS ARE RESPONSIBLE FOR THEIR PRODUCTS AND APPLICATIONS USING NATIONAL COMPONENTS. PRIOR TO USING OR DISTRIBUTING ANY PRODUCTS THAT INCLUDE NATIONAL COMPONENTS, BUYERS SHOULD PROVIDE ADEQUATE DESIGN, TESTING AND OPERATING SAFEGUARDS.

EXCEPT AS PROVIDED IN NATIONAL'S TERMS AND CONDITIONS OF SALE FOR SUCH PRODUCTS, NATIONAL ASSUMES NO LIABILITY WHATSOEVER, AND NATIONAL DISCLAIMS ANY EXPRESS OR IMPLIED WARRANTY RELATING TO THE SALE AND/OR USE OF NATIONAL PRODUCTS INCLUDING LIABILITY OR WARRANTIES RELATING TO FITNESS FOR A PARTICULAR PURPOSE, MERCHANTABILITY, OR INFRINGEMENT OF ANY PATENT, COPYRIGHT OR OTHER INTELLECTUAL PROPERTY RIGHT.

LIFE SUPPORT POLICY

NATIONAL'S PRODUCTS ARE NOT AUTHORIZED FOR USE AS CRITICAL COMPONENTS IN LIFE SUPPORT DEVICES OR SYSTEMS WITHOUT THE EXPRESS PRIOR WRITTEN APPROVAL OF THE CHIEF EXECUTIVE OFFICER AND GENERAL COUNSEL OF NATIONAL SEMICONDUCTOR CORPORATION. As used herein:

Life support devices or systems are devices which (a) are intended for surgical implant into the body, or (b) support or sustain life and whose failure to perform when properly used in accordance with instructions for use provided in the labeling can be reasonably expected to result in a significant injury to the user. A critical component is any component in a life support device or system whose failure to perform can be reasonably expected to cause the failure of the life support device or system or to affect its safety or effectiveness.

National Semiconductor and the National Semiconductor logo are registered trademarks of National Semiconductor Corporation. All other brand or product names may be trademarks or registered trademarks of their respective holders.

Copyright© 2008 National Semiconductor Corporation

For the most current product information visit us at www.national.com



National Semiconductor Americas Technical Support Center
 Email: support@nsc.com
 Tel: 1-800-272-9959

National Semiconductor Europe Technical Support Center
 Email: europe.support@nsc.com
 German Tel: +49 (0) 180 5010 771
 English Tel: +44 (0) 870 850 4288

National Semiconductor Asia Pacific Technical Support Center
 Email: ap.support@nsc.com

National Semiconductor Japan Technical Support Center
 Email: jpn.feedback@nsc.com