

LM4930 Boomer® Audio Power Amplifier Series

Audio Subsystem with Stereo Headphone & Mono Speaker Amplifiers

General Description

The LM4930 is an integrated audio subsystem that supports voice and digital audio functions. The LM4930 includes a high quality I²S input stereo DAC, a voice band codec, a stereo headphone amplifier and a high-power mono speaker amplifier. It is primarily designed for demanding applications in mobile phones and other portable devices.

The LM4930 features an I²S serial interface for full range audio, a 16-bit PCM bi-directional serial interface for the voice band codec and an two-wire interface for control. The full range music path features an SNR of 86dB with a 16-bit 48kHz input. The stereo DAC can also be used while the voice codec is in use. The headphone amplifier delivers 25mW_{RMS} to a 32Ω single-ended stereo load with less than 0.5% distortion (THD+N) when AV_{DD} = 3V. The mono speaker amplifier delivers up to 330mW into an 8Ω load with less than 1% distortion when AV_{DD} = 3V.

The LM4930 employs advanced techniques to reduce power consumption, to reduce controller overhead and to eliminate click and pop. Boomer audio power amplifiers were designed specifically to provide high quality output power with a minimal amount of external components. It is, therefore, ideally suited for mobile phone and other low voltage applications where minimal power consumption is a primary requirement.

Key Specifications

■ P _{LS OUT} at AV _{DD} = 5.0V, 8Ω 1% THD+N	1W (typ)
■ P _{LS OUT} at AV _{DD} = 3.0V, 8Ω 1% THD+N	330mW (typ)
■ P _{H/P OUT} at AV _{DD} = 3.0V, 32Ω 0.5% THD+N	25mW (typ)
■ Supply voltage range	
DV _{DD} (Note 8)	2.6V to 4.5V
AV _{DD} (Note 8)	2.6V to 5.5V
■ Total shutdown current	2μA (typ)
■ PSRR at 217Hz, AV _{DD} = 3V	50dB (typ)

Features

- 16-bit resolution 48kHz stereo DAC
- 16-bit resolution 8kHz voice codec
- I²S digital audio data serial interface
- Two-wire serial control interface
- PCM voice audio data serial interface
- 25mW/channel stereo headphone amplifier
- 330mW mono 8Ω amplifier (at AV_{DD} = 3.0V)
- 32-step volume control for audio output amplifiers
- No snubber networks or bootstrap capacitors are required by the headphone or hands-free amplifiers
- Digital sidetone generation with adjustable attenuation
- Gain controllable headphone amp, mono BTL amp, mic preamp
- Available in the 36-bump micro SMD and 44-lead LLP packages

Applications

- Mobile Phones
- Mobile/low power audio appliances
- PDAs

Typical Application

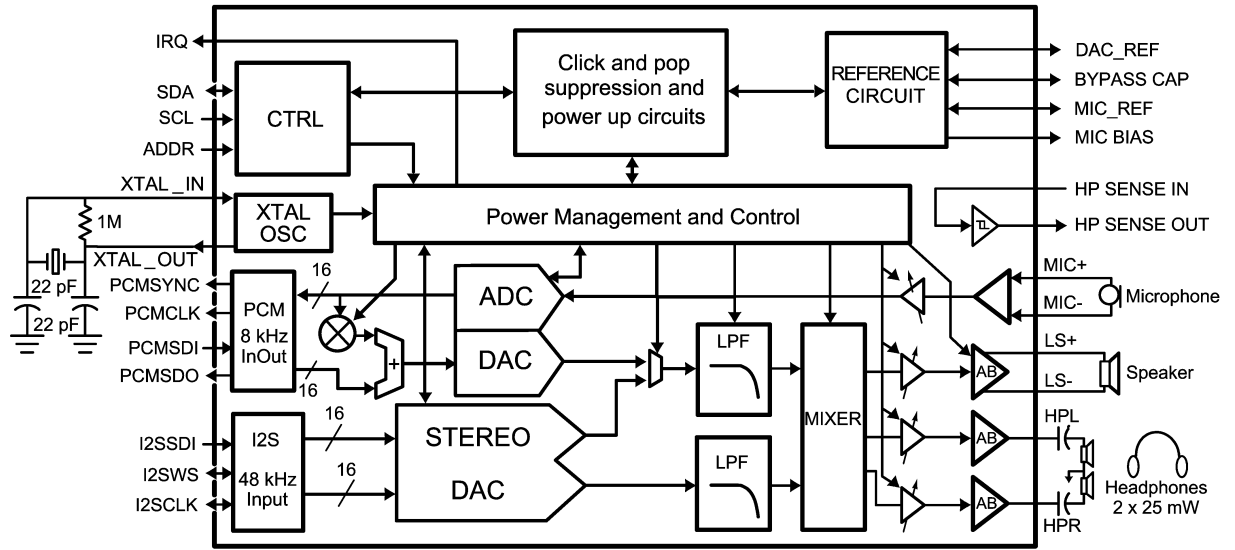

20072003

FIGURE 1. Typical I²S + Voice codec application circuit for mobile phones

Connection Diagrams

36-Bump micro SMD

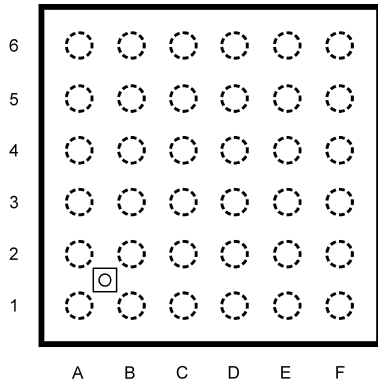

Top View

Order Number LM4930ITL
See NS Package Number MKT - TLA36KRA

micro SMD Marking

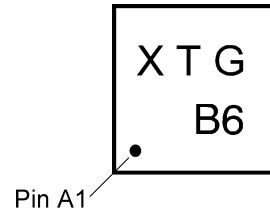

Top View
X - Date Code
T - Die Traceability
G - Boomer Family
B6 - LM4930ITL

44 - Lead LLP

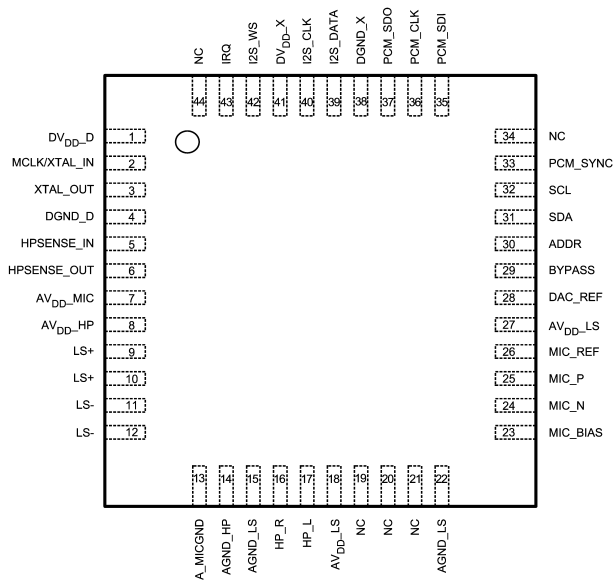

Top View

Order Number LM4930LQ
See NS Package Number MKT - LQA44A

44 - Lead LLP Marking

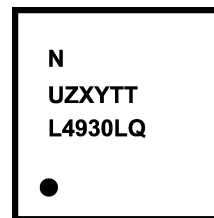

Top View
N - National Logo
U - Wafer Fab Code
Z - Assembly Plant Code
XY - Two Digit Date Code
TT - Die Run Code
L4930LQ - LM4930LQ

Pin Descriptions

A1	MIC_P	Microphone positive differential input
A2	MIC_N	Microphone negative differential input
A3	AVDD_MIC	Analog V_{dd} for microphone preamp
A4	DAC_REF	D/A converter reference voltage
A5	SDA	Two-wire control interface serial data pin
A6	SCL	Two-wire control interface serial clock pin
B1	AGND_MIC	Analog ground for microphone preamp
B2	MIC_BIAS	Microphone bias supply output (2V)
B3	MIC_REF	Internal fixed-reference bypass capacitor decoupling pin
B4	ADDR	Control bus address select pin
B5	PCM_SDI	PCM serial data in
B6	PCM_CLK	PCM Serial clock pin
C1	AVDD_HP	Analog V_{dd} for headphone amplifier
C2	NC	No Connect
C3	BYPASS	Half-supply bypass capacitor decoupling pin
C4	PCM_SYNC	PCM Frame sync pin
C5	I2S_DATA	I ² S serial data input
C6	DGND_D	Digital ground
D1	HP_L	Headphone amplifier connection (Left)
D2	HP_R	Headphone amplifier connection (Right)
D3	HPSENSE_IN	Connection for sense pin of headphone jack
D4	PCM_SDO	PCM serial data out
D5	I2S_CLK	I ² S serial bit clock
D6	DVDD_D	Digital V_{dd}
E1	AGND_HP	Analog ground for headphone amplifier
E2	LS-	Loudspeaker amplifier BTL negative out (-)
E3	HPSENSE_OUT	Logic output pin to indicate headphone connection status. Outputs logic high when HPSENSE_IN is high and outputs logic low when HPSENSE_IN is low. See Figure 5 for suggested application circuit
E4	IRQ	LM4930 mode status indicator pin
E5	I2S_WS	I ² S word select
E6	XTAL_OUT	Negative feedback source for external crystal MCLK
F1	AGND_LS	Analog ground for loudspeaker amplifier
F2	LS+	Loudspeaker amplifier BTL positive out (+)
F3	AVDD_LS	Analog V_{DD} for loudspeaker amplifier
F4	DGND_X	Digital ground
F5	DVDD_X	Digital V_{DD}
F6	MCLK/XTAL_IN	12.288MHz or 24.576MHz Master Clock from crystal (via XTAL OUT) or external source

System Control Registers

The LM4930 is controlled with a two-wire serial interface. This interface is used to configure the operating mode, digital interfaces, and delta-sigma modulators. The LM4930 is

controlled by writing information into a series of write-only registers, each with its own unique 7 bit address. The following registers are programmable:

BASIC CONFIG REGISTER

This register is used to configure the I²S and PCM interfaces as well as the 48kHz DAC module. The 7 bit address for the BASICCONFIG register is XX10000. (X = 0 if ADDR is set to logic 0) (X = 1 if ADDR is set to logic 1)

BASIC CONFIGURATION (XX1000). (Set = logic 1, Clear = logic 0)

BIT	15	14	13	12	11	10	9	8	7	6	5	4	3	2	1	0
RESET	0	0	0	0	0	0	0	0	0	0	0	0	0	0	0	0

Address	Register	Description																																																												
3:0	MODE	The LM4930 can be placed in one of several modes that dictate the basic operation. When a new mode is selected the LM4930 will change operation silently and will re-configure the power management profile automatically. The modes are described as follows: (Note 14)																																																												
		<table border="1"> <thead> <tr> <th>Mode</th> <th>Mono Speaker Amplifier Source</th> <th>Headphone Left Source</th> <th>Headphone Right Source</th> <th>Comment</th> </tr> </thead> <tbody> <tr> <td>0000</td> <td>None</td> <td>None</td> <td>None</td> <td>Powerdown mode</td> </tr> <tr> <td>0001</td> <td>None</td> <td>None</td> <td>None</td> <td>Standby mode</td> </tr> <tr> <td>0010</td> <td>Voice</td> <td>None</td> <td>None</td> <td>Mono speaker mode</td> </tr> <tr> <td>0011</td> <td>None</td> <td>Voice</td> <td>Voice</td> <td>Headphone call mode</td> </tr> <tr> <td>0100</td> <td>Voice</td> <td>Voice</td> <td>Voice</td> <td>Conference call mode</td> </tr> <tr> <td>0101</td> <td>Audio (L+R)</td> <td>None</td> <td>None</td> <td>L+R mixed to mono speaker</td> </tr> <tr> <td>0110</td> <td>None</td> <td>Audio (Left)</td> <td>Audio (Right)</td> <td>Headphone stereo audio</td> </tr> <tr> <td>0111</td> <td>Audio (L+R)</td> <td>Audio (Left)</td> <td>Audio (Right)</td> <td>L+R mixed to mono speaker + stereo headphone audio</td> </tr> <tr> <td>1000</td> <td>Audio (Left)</td> <td>Voice</td> <td>Voice</td> <td>Mixed Mode</td> </tr> <tr> <td>1001</td> <td>Voice + Audio (Left)</td> <td>Voice</td> <td>Voice</td> <td>Mixed mode</td> </tr> <tr> <td>1010</td> <td>Voice</td> <td>Audio (Left)</td> <td>Audio (Left)</td> <td>Mixed Mode</td> </tr> </tbody> </table>	Mode	Mono Speaker Amplifier Source	Headphone Left Source	Headphone Right Source	Comment	0000	None	None	None	Powerdown mode	0001	None	None	None	Standby mode	0010	Voice	None	None	Mono speaker mode	0011	None	Voice	Voice	Headphone call mode	0100	Voice	Voice	Voice	Conference call mode	0101	Audio (L+R)	None	None	L+R mixed to mono speaker	0110	None	Audio (Left)	Audio (Right)	Headphone stereo audio	0111	Audio (L+R)	Audio (Left)	Audio (Right)	L+R mixed to mono speaker + stereo headphone audio	1000	Audio (Left)	Voice	Voice	Mixed Mode	1001	Voice + Audio (Left)	Voice	Voice	Mixed mode	1010	Voice	Audio (Left)	Audio (Left)	Mixed Mode
		Mode	Mono Speaker Amplifier Source	Headphone Left Source	Headphone Right Source	Comment																																																								
		0000	None	None	None	Powerdown mode																																																								
		0001	None	None	None	Standby mode																																																								
		0010	Voice	None	None	Mono speaker mode																																																								
		0011	None	Voice	Voice	Headphone call mode																																																								
		0100	Voice	Voice	Voice	Conference call mode																																																								
		0101	Audio (L+R)	None	None	L+R mixed to mono speaker																																																								
		0110	None	Audio (Left)	Audio (Right)	Headphone stereo audio																																																								
		0111	Audio (L+R)	Audio (Left)	Audio (Right)	L+R mixed to mono speaker + stereo headphone audio																																																								
		1000	Audio (Left)	Voice	Voice	Mixed Mode																																																								
		1001	Voice + Audio (Left)	Voice	Voice	Mixed mode																																																								
1010	Voice	Audio (Left)	Audio (Left)	Mixed Mode																																																										
4	SOFT_RESET	Resets the LM4930, excluding the control registers																																																												
5	PCM_LONG	If set the PCM interface uses a long frame sync. (Note 12)																																																												
6	PCM_COMPANDED	If set the 8 MSBs are presumed to be companded data and the 8 LSBs are ignored. (Note 12)																																																												
7	PCM_LAW	If set, the companded G711 data is set to be A-law, else μ -law is assumed (Note 12)																																																												
8:9	PCM_SYNC_MODE	Sets 1 (00h), 2 (01h) or 4(10h) 16 bit frames per sync. The PCM_SDO pin is tri-stated during the latter frames. (Note 12)																																																												
10	PCM_ALWAYS_ON	This bit should be set if another codec is using the PCM bus. When set, the LM4930 will drive the clock and sync signals in all modes except Powerdown (Note 12)																																																												
11	I2S_M/S	I2S master or slave select. If set then I2S = master. Cleared = slave																																																												
12	I2S_RES	I2S resolution select. If set then 32 bits per frame. If cleared then 16 bits per frame																																																												
13	RSVD	RESERVED (Note 13)																																																												
14	RSVD	RESERVED (Note 13)																																																												
15	RSVD	RESERVED (Note 13)																																																												

System Control Registers (Continued)

VOICE/TEST CONFIG REGISTERS

This register configures the voiceband codec, sidetone attenuation, and selected control functions. The 7 bit address for the VOICE TESTCONFIG register is XX10001. (X = 0 if ADDR is set to logic 0) (X = 1 if ADDR is set to logic 1)

VOICETESTCONFIG (XX10001). (Set = logic 1, Clear = logic 0)

BIT	15	14	13	12	11	10	9	8	7	6	5	4	3	2	1	0
RESET	0	0	0	0	0	0	0	0	0	0	0	0	0	0	0	0

Address	Register	Description																																				
0	CLASS	If set, configures the chip for use with an external class D or linear amplifier and turns the BTL speaker output into a buffer. (Note 12)																																				
4:1	SIDESTONE_ATTEN	<p>Programs the attenuation of the digital sidetone. Attenuation is set as follows:</p> <table border="1"> <thead> <tr> <th>4:1</th> <th>Sidetone Attenuation</th> <th>4:1</th> <th>Sidetone Attenuation</th> </tr> </thead> <tbody> <tr> <td>0000</td> <td>Mute</td> <td>1000</td> <td>-9dB</td> </tr> <tr> <td>0001</td> <td>-30dB</td> <td>1001</td> <td>-6dB</td> </tr> <tr> <td>0010</td> <td>-27dB</td> <td>1010</td> <td>-3dB</td> </tr> <tr> <td>0011</td> <td>-24dB</td> <td>1011</td> <td>0dB</td> </tr> <tr> <td>0100</td> <td>-21dB</td> <td>1100</td> <td>Mute</td> </tr> <tr> <td>0101</td> <td>-18dB</td> <td>1101</td> <td>Mute</td> </tr> <tr> <td>0110</td> <td>-15dB</td> <td>1110</td> <td>Mute</td> </tr> <tr> <td>0111</td> <td>-12dB</td> <td>1111</td> <td>Mute</td> </tr> </tbody> </table>	4:1	Sidetone Attenuation	4:1	Sidetone Attenuation	0000	Mute	1000	-9dB	0001	-30dB	1001	-6dB	0010	-27dB	1010	-3dB	0011	-24dB	1011	0dB	0100	-21dB	1100	Mute	0101	-18dB	1101	Mute	0110	-15dB	1110	Mute	0111	-12dB	1111	Mute
4:1	Sidetone Attenuation	4:1	Sidetone Attenuation																																			
0000	Mute	1000	-9dB																																			
0001	-30dB	1001	-6dB																																			
0010	-27dB	1010	-3dB																																			
0011	-24dB	1011	0dB																																			
0100	-21dB	1100	Mute																																			
0101	-18dB	1101	Mute																																			
0110	-15dB	1110	Mute																																			
0111	-12dB	1111	Mute																																			
5	AUTOSIDE	This feature is included for use with the mono speaker in hands-free applications where sidetones may not be desirable. If set, the sidetone is always muted in modes when voice is played on the mono speaker (0010, 0100, 1001, and 1010), otherwise the sidetone is present at whatever level is set in the attenuation control register																																				
6	CLOCK_DIV	If set, allows for the use of a 24.576MHz crystal. Default setting is for 12.288MHz crystal. (Note 12)																																				
7	ZXD_DISABLE	Disables the zero crossing detect in the stereo DAC to guarantee immediate mode changes rather than waiting for a zero cross. (Note 11)																																				
8:9	RSVD	RESERVED (Note 13)																																				
10:11	CAP_SIZE	<p>Set to accommodate different bypass capacitor values to give correct turn-off delay and click/pop performance. Value is set as follows: (Note 12)</p> <table border="1"> <thead> <tr> <th>10:11</th> <th>Delay</th> <th>Bypass Capacitor Size</th> </tr> </thead> <tbody> <tr> <td>00</td> <td>25ms</td> <td>0.1μF</td> </tr> <tr> <td>01</td> <td>50ms</td> <td>0.39μF</td> </tr> <tr> <td>10</td> <td>85ms</td> <td>1μF</td> </tr> <tr> <td>11</td> <td>RESERVED</td> <td>RESERVED</td> </tr> </tbody> </table>	10:11	Delay	Bypass Capacitor Size	00	25ms	0.1 μ F	01	50ms	0.39 μ F	10	85ms	1 μ F	11	RESERVED	RESERVED																					
10:11	Delay	Bypass Capacitor Size																																				
00	25ms	0.1 μ F																																				
01	50ms	0.39 μ F																																				
10	85ms	1 μ F																																				
11	RESERVED	RESERVED																																				
12	ZXDS_SLOW	If set, this forces the stereo DAC outputs to wait for a zero crossing before powering down																																				
13	MUTE_LS	If set, mutes the loudspeaker amplifier in any mode where it is not already muted																																				
14	MUTE_HP	If set, mutes the headphone amplifier in any mode where it is not already muted																																				
15	MUTE_MIC	If set, mutes the microphone preamp																																				

System Control Registers (Continued)

GAIN CONFIG REGISTERS

This register is used to control the gain of the headphone amplifier, the loudspeaker amplifier, and the microphone preamplifier. The 7 bit address for the GAINCONFIG register is XX10010. (X = 0 if ADDR is set to logic 0) (X = 1 if ADDR is set to logic 1)

GAINCONFIG (XX10010). (Set = logic 1, Clear = logic 0)

BIT	15	14	13	12	11	10	9	8	7	6	5	4	3	2	1	0
RESET	0	0	0	0	0	0	0	0	0	0	0	0	0	0	0	0

Address	Register	Description																																																																				
4:0	LOUDSPKR_GAIN	Programs the gain of the loudspeaker amplifier. Gain is set as follows:																																																																				
		<table border="1"> <thead> <tr> <th>4:0</th> <th>Loudspeaker Gain</th> <th>4:0</th> <th>Loudspeaker Gain</th> </tr> </thead> <tbody> <tr> <td>00000</td> <td>-34.5dB</td> <td>10000</td> <td>-10.5dB</td> </tr> <tr> <td>00001</td> <td>-33dB</td> <td>10001</td> <td>-9dB</td> </tr> <tr> <td>00010</td> <td>-31.5dB</td> <td>10010</td> <td>-7.5dB</td> </tr> <tr> <td>00011</td> <td>-30dB</td> <td>10011</td> <td>-6dB</td> </tr> <tr> <td>00100</td> <td>-28.5dB</td> <td>10100</td> <td>-4.5dB</td> </tr> <tr> <td>00101</td> <td>-27dB</td> <td>10101</td> <td>-3dB</td> </tr> <tr> <td>00110</td> <td>-25.5dB</td> <td>10110</td> <td>-1.5dB</td> </tr> <tr> <td>00111</td> <td>-24dB</td> <td>10111</td> <td>0dB</td> </tr> <tr> <td>01000</td> <td>-22.5dB</td> <td>11000</td> <td>1.5dB</td> </tr> <tr> <td>01001</td> <td>-21dB</td> <td>11001</td> <td>3dB</td> </tr> <tr> <td>01010</td> <td>-19.5dB</td> <td>11010</td> <td>4.5dB</td> </tr> <tr> <td>01011</td> <td>-18dB</td> <td>11011</td> <td>6dB</td> </tr> <tr> <td>01100</td> <td>-16.5dB</td> <td>11100</td> <td>7.5dB</td> </tr> <tr> <td>01101</td> <td>-15dB</td> <td>11101</td> <td>9dB</td> </tr> <tr> <td>01110</td> <td>-13.5dB</td> <td>11110</td> <td>10.5dB</td> </tr> <tr> <td>01111</td> <td>-12dB</td> <td>11111</td> <td>12dB</td> </tr> </tbody> </table>	4:0	Loudspeaker Gain	4:0	Loudspeaker Gain	00000	-34.5dB	10000	-10.5dB	00001	-33dB	10001	-9dB	00010	-31.5dB	10010	-7.5dB	00011	-30dB	10011	-6dB	00100	-28.5dB	10100	-4.5dB	00101	-27dB	10101	-3dB	00110	-25.5dB	10110	-1.5dB	00111	-24dB	10111	0dB	01000	-22.5dB	11000	1.5dB	01001	-21dB	11001	3dB	01010	-19.5dB	11010	4.5dB	01011	-18dB	11011	6dB	01100	-16.5dB	11100	7.5dB	01101	-15dB	11101	9dB	01110	-13.5dB	11110	10.5dB	01111	-12dB	11111	12dB
		4:0	Loudspeaker Gain	4:0	Loudspeaker Gain																																																																	
		00000	-34.5dB	10000	-10.5dB																																																																	
		00001	-33dB	10001	-9dB																																																																	
		00010	-31.5dB	10010	-7.5dB																																																																	
		00011	-30dB	10011	-6dB																																																																	
		00100	-28.5dB	10100	-4.5dB																																																																	
		00101	-27dB	10101	-3dB																																																																	
		00110	-25.5dB	10110	-1.5dB																																																																	
		00111	-24dB	10111	0dB																																																																	
		01000	-22.5dB	11000	1.5dB																																																																	
		01001	-21dB	11001	3dB																																																																	
		01010	-19.5dB	11010	4.5dB																																																																	
		01011	-18dB	11011	6dB																																																																	
		01100	-16.5dB	11100	7.5dB																																																																	
01101	-15dB	11101	9dB																																																																			
01110	-13.5dB	11110	10.5dB																																																																			
01111	-12dB	11111	12dB																																																																			
9:5	HP_GAIN	Programs the gain of the headphone amplifier. Gain is set as follows:																																																																				
		<table border="1"> <thead> <tr> <th>9:5</th> <th>Headphone Gain</th> <th>9:5</th> <th>Headphone Gain</th> </tr> </thead> <tbody> <tr> <td>00000</td> <td>-46dB</td> <td>10000</td> <td>-22.5dB</td> </tr> <tr> <td>00001</td> <td>-45dB</td> <td>10001</td> <td>-21dB</td> </tr> <tr> <td>00010</td> <td>-43.5dB</td> <td>10010</td> <td>-19.5dB</td> </tr> <tr> <td>00011</td> <td>-42db</td> <td>10011</td> <td>-18dB</td> </tr> <tr> <td>00100</td> <td>-40.5dB</td> <td>10100</td> <td>-16.5dB</td> </tr> <tr> <td>00101</td> <td>-39dB</td> <td>10101</td> <td>-15dB</td> </tr> <tr> <td>00110</td> <td>-37.5dB</td> <td>10110</td> <td>-13.5dB</td> </tr> <tr> <td>00111</td> <td>-36dB</td> <td>10111</td> <td>-12dB</td> </tr> <tr> <td>01000</td> <td>-34.5dB</td> <td>11000</td> <td>-10.5dB</td> </tr> <tr> <td>01001</td> <td>-33dB</td> <td>11001</td> <td>-9dB</td> </tr> <tr> <td>01010</td> <td>-31.5dB</td> <td>11010</td> <td>-7.5dB</td> </tr> <tr> <td>01011</td> <td>-30dB</td> <td>11011</td> <td>-6dB</td> </tr> <tr> <td>01100</td> <td>-28.5dB</td> <td>11100</td> <td>-4.5dB</td> </tr> <tr> <td>01101</td> <td>-27dB</td> <td>11101</td> <td>-3dB</td> </tr> <tr> <td>01110</td> <td>-25.5dB</td> <td>11110</td> <td>-1.5dB</td> </tr> <tr> <td>01111</td> <td>-24dB</td> <td>11111</td> <td>0dB</td> </tr> </tbody> </table>	9:5	Headphone Gain	9:5	Headphone Gain	00000	-46dB	10000	-22.5dB	00001	-45dB	10001	-21dB	00010	-43.5dB	10010	-19.5dB	00011	-42db	10011	-18dB	00100	-40.5dB	10100	-16.5dB	00101	-39dB	10101	-15dB	00110	-37.5dB	10110	-13.5dB	00111	-36dB	10111	-12dB	01000	-34.5dB	11000	-10.5dB	01001	-33dB	11001	-9dB	01010	-31.5dB	11010	-7.5dB	01011	-30dB	11011	-6dB	01100	-28.5dB	11100	-4.5dB	01101	-27dB	11101	-3dB	01110	-25.5dB	11110	-1.5dB	01111	-24dB	11111	0dB
		9:5	Headphone Gain	9:5	Headphone Gain																																																																	
		00000	-46dB	10000	-22.5dB																																																																	
		00001	-45dB	10001	-21dB																																																																	
		00010	-43.5dB	10010	-19.5dB																																																																	
		00011	-42db	10011	-18dB																																																																	
		00100	-40.5dB	10100	-16.5dB																																																																	
		00101	-39dB	10101	-15dB																																																																	
		00110	-37.5dB	10110	-13.5dB																																																																	
		00111	-36dB	10111	-12dB																																																																	
		01000	-34.5dB	11000	-10.5dB																																																																	
		01001	-33dB	11001	-9dB																																																																	
		01010	-31.5dB	11010	-7.5dB																																																																	
		01011	-30dB	11011	-6dB																																																																	
		01100	-28.5dB	11100	-4.5dB																																																																	
01101	-27dB	11101	-3dB																																																																			
01110	-25.5dB	11110	-1.5dB																																																																			
01111	-24dB	11111	0dB																																																																			
13:10	MIC_GAIN	Programs the gain of the microphone amplifier. Gain is set as follows:																																																																				

System Control Registers (Continued)

GAIN CONFIG REGISTERS (Continued)

		13:10	Mic Preamp Gain
		0000	17dB
		0001	19dB
		0010	21dB
		0011	23dB
		0100	25dB
		0101	27dB
		0110	29dB
		0111	31dB
		1000	33dB
		1001	35dB
		1010	37dB
		1011	39dB
		1100	41dB
		1101	43dB
		1110	45dB
		1111	47dB
15:14	RSVD	RESERVED (Note 13)	

Timing Diagrams

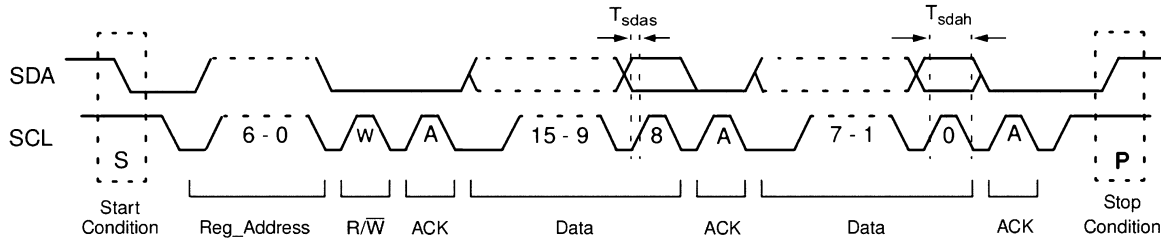

20072009

FIGURE 2. Two-wire control Interface Timing Diagram

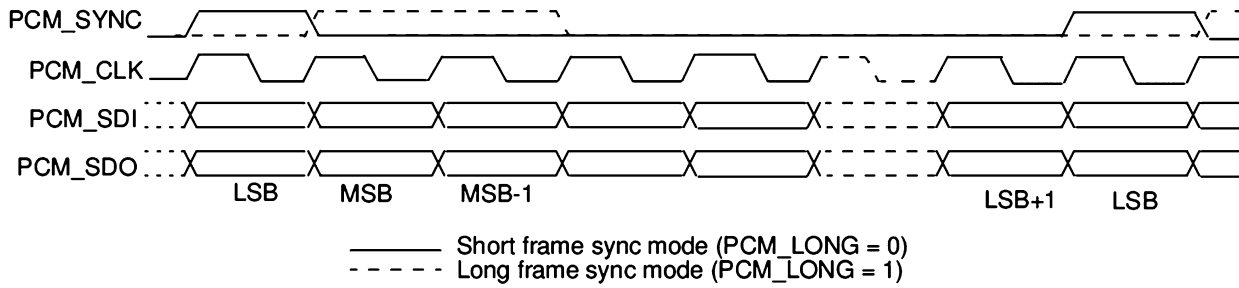

20072008

FIGURE 3. PCM Receive Timing Diagram

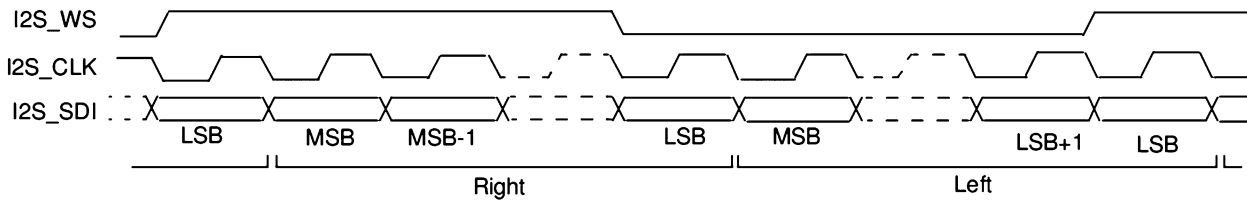

20072007

FIGURE 4. I²S Transmit Timing Diagram

Absolute Maximum Ratings (Notes 1, 2)

If Military/Aerospace specified devices are required, please contact the National Semiconductor Sales Office/Distributors for availability and specifications.

Analog Supply Voltage	6.0V
Digital Storage Supply Voltage	6.0V
Storage temperature	-65°C to +150°C
Power Dissipation (Note 3)	Internally Limited
ESD Susceptibility	
Human Body Model (Note 4)	2000V
Machine Model (Note 5)	200V
Junction temperature	150°C

Thermal Resistance

 θ_{JA} - TLA36KRA

105°C/W

 θ_{JA} - LQA44A (Note 17)

27°C/W

Operating Ratings (Note 3)

Temperature Range

 $T_{MIN} \leq T_A \leq T_{MAX}$ $-30^\circ\text{C} \leq T_A \leq +85^\circ\text{C}$

Supply Voltage

 DV_{DD} (Note 8)

2.6V - 4.5V

 AV_{DD} (Note 8)

2.6V - 5.5V

Electrical Characteristics $DV_{DD} = 3.3\text{V}$, $AV_{DD} = 5\text{V}$, $R_{LHP} = 32\Omega$, $R_{LHF} = 8\Omega$

(Notes 1, 2, 8)

The following specifications apply for the circuit shown in Figure 1, unless otherwise specified. Limits apply for $T_A = 25^\circ\text{C}$.

Symbol	Parameter	Conditions	LM4930		Units (Limits)
			Typical (Note 6)	Limits (Notes 7, 15)	
DI_{DD}	Digital Power Supply Current	$f_{MCLK} = 12.288\text{MHz}$			
		Output Mode = "0010"	2		
		Output Mode = "0011"			
		Output Mode = "0100"			
DI_{DD}	Digital Power Supply Current	Output Mode = "0101"	4.4		
		Output Mode = "0110"			
		Output Mode = "0111"			
		Output Mode = "1000"	4.9	8	mA (max)
AI_{DD}	Analog Power Supply Quiescent Current	$f_{MCLK} = 12.288\text{MHz}$; No Load			
		Output Mode = "0010"	7.0		
		Output Mode = "0011"	6.3		
		Output Mode = "0100"	8.0		
		Output Mode = "0101"	8.2		
		Output Mode = "0110"	7.4		
		Output Mode = "0111"	8.7		
		Output Mode = "1000"	9.5	14	mA (max)
		Output Mode = "1001"			
Output Mode = "1010"					
DI_{SD}	Digital Powerdown Current	$f_{MCLK} = 12.288\text{MHz}$ Output Mode = "0000" Powerdown Mode	1	7	μA (max)
AI_{SD}	Analog Powerdown Current	$f_{MCLK} = 12.288\text{MHz}$ Output Mode = "0000" Powerdown Mode	1	2	μA (max)
DI_{ST}	Digital Standby Current	$f_{MCLK} = 12.288\text{MHz}$ Output Mode = "0001" Standby Mode	1.4	2	mA (max)
AI_{ST}	Analog Standby Current	$f_{MCLK} = 12.288\text{MHz}$ Output Mode = "0001" Standby Mode	230	1000	μA (max)
V_{FS_LS}	Full-Scale Output Voltage (Mono speaker amplifier)	CLASS = 0; 0dB gain setting; 8 Ω BTL load (Note 10)	2.5		V_{P-P}
V_{FS_HP}	Full-Scale Output Voltage (Headphone amplifier)	0dB gain setting; 32 Ω Stereo Load (Note 10)	2.5		V_{P-P}

Electrical Characteristics $V_{DD} = 3.3V$, $A_{V_{DD}} = 5V$, $R_{LHP} = 32\Omega$, $R_{LHF} = 8\Omega$

(Notes 1, 2, 8) (Continued)

The following specifications apply for the circuit shown in Figure 1, unless otherwise specified. Limits apply for $T_A = 25^\circ C$.

Symbol	Parameter	Conditions	LM4930		Units (Limits)
			Typical (Note 6)	Limits (Notes 7, 15)	
V_{MIC_BIAS}	Mic Bias Voltage		2.0		V
THD+N	Headphone Amplifier Total Harmonic Motion Distortion + Noise	$f_{IN} = 1\text{ kHz}$, $P_{OUT} = 7.5\text{mW}$; 32Ω Stereo Load	0.07		%
P_{OHP}	Headphone Amplifier Output Power	THD+N = 0.5%, $f_{OUT} = 1\text{ kHz}$	27	20	mW (min)
P_{OLS}	Mono Speaker Amplifier Output Power	THD+N = 1%, $f_{OUT} = 1\text{ kHz}$	1		W
PSRR	Power Supply Rejection Ratio	$C_{BYPASS} = 1.0\mu F$ $C_{DAC_REF} = 1.0\mu F$ $V_{RIPPLE} = 200\text{mV}_{P-P}$ @ 217Hz, MIC_P, MIC_N terminated with 10Ω to ground	55	45	dB (min)
SNR (Voice)	Signal-to-Noise Ratio (Voice DAC Path)	Signal = V_o at $f = 1\text{ kHz}$ @1% THD+N, 32Ω Stereo Load; Noise = digital zero, A-weighted, 0dB gain setting	72		dB
SNR (Music)	Signal-to-Noise Ratio (Music Audio Path)	Signal = V_o at $f = 1\text{ kHz}$ @1% THD+N, 32Ω Stereo Load; Noise = digital zero, A-weighted; 0dB gain setting	86		dB
DR (Voice)	Dynamic Range (Voice DAC Path)	Signal = V_o at $f = 1\text{ kHz}$ @1% THD+N, 32Ω Stereo Load; Noise for -60dBFS digital input; A-weighted; 0dB gain setting	72		dB
DR (Music)	Dynamic Range (Music Audio Path)	Signal = V_o at $f = 1\text{ kHz}$ @1% THD+N, 32Ω Stereo Load; Noise for -60dBFS digital input; A-weighted, 0dB gain setting	86		dB
SNR_{ADC}	Signal-to-Noise Ratio (Voice ADC Path)	Reference signal = 0dBFS MIC_P, MIC_N terminated with 10Ω to ground; A-weighted; 47dB MIC preamp gain setting	75		dB
DR_{ADC}	Dynamic Range (Voice ADC Path)	Reference signal = 0dBFS Noise for -60dBFS digital input; A-weighted; 47dB MIC preamp gain setting	75		dB
X_{TALK}	Stereo Channel-to-Channel Crosstalk	$f_s = 48\text{ kHz}$, $f_{IN} = 1\text{ kHz}$ sinewave at -3 dB_{FS}	75		dB
V_{MIC-IN}	Maximum Differential MIC Input Voltage	17dB MIC Preamp gain setting	570		mV_{P-P}
R_{VDAC}	Voice DAC Ripple	300Hz - 3.3kHz through head-phone output.	+/-0.15	+/-0.2	dB (max)
R_{VADC}	Voice ADC Ripple	300Hz - 3.3kHz through head-phone output.	+/-0.25	+/-0.3	dB (max)
PB_{VDAC}	Voice DAC Passband	-3dB Point	3.46		kHz
SBA_{VDAC}	Voice DAC Stopband Attenuation	Above 4kHz	72		dB
UPB_{VADC}	Voice ADC Upper Passband Cutoff Frequency.	Upper -3dB Point	3.47		kHz

Electrical Characteristics $V_{DD} = 3.3V$, $A_{V_{DD}} = 5V$, $R_{LHP} = 32\Omega$, $R_{LHF} = 8\Omega$

(Notes 1, 2, 8) (Continued)

The following specifications apply for the circuit shown in Figure 1, unless otherwise specified. Limits apply for $T_A = 25^\circ C$.

Symbol	Parameter	Conditions	LM4930		Units (Limits)
			Typical (Note 6)	Limits (Notes 7, 15)	
LPB_{VADC}	Voice ADC Lower Passband Cutoff Frequency.	Lower -3dB Point	0.230		kHz
SBA_{VADC}	Voice ADC Stopband Attenuation	Above 4kHz	65		dB
SBA_{NOTCH}	Voice ADC Notch Attenuation	Centered on 55Hz, figure gives worst case attenuation for 50Hz & 60Hz.	58		dB
R_{DAC}	Audio DAC Ripple	20Hz - 20kHz through head-phone output.	+/-0.1	+/-0.2	dB (max)
PB_{DAC}	Audio DAC Passband Width	-3dB point	22.7		kHz
SBA_{DAC}	Audio DAC Stopband Attenuation	Above 24kHz	76		dB
DR_{DAC}	Audio DAC Dynamic Range Digital Filter Section	Signal = VO at f = 1kHz @ 1% THD+N; f = 1kHz; Noise for -60dBFS digital input; 0dB gain; A-weighted	97		dB
SNR_{DAC}	Audio DAC SNR Digital Filter Section	Signal = VO at f = 1kHz @ 1% THD+N; f = 1kHz; Noise for -60dBFS digital input; 0dB gain; A-weighted	97		dB
ΔA_{CH-CH}	Stereo Channel-to-Channel Gain Mismatch		0.3		dB
V_{IL}	Digital Input: Logic Low Voltage Level		0.4		V
V_{IH}	Digital Input: Logic High Voltage Level		1.4		V
	Volume Control Range (Headphone amplifiers)	Maximum Attenuation Minimum Attenuation	-46.5 0		dB dB
	Volume Control Range (Mono speaker amplifier)	Minimum Gain Maximum Gain	-34.5 12		dB dB
	Volume Control Step Size (Output amplifiers)		1.5		dB
	Volume Control Range (Microphone Preamp)	Minimum Gain Maximum Gain	17 47		dB dB
	Volume Control Step Size (Microphone Preamp)		2		dB
	Side Tone Attenuation Range	Maximum Attenuation Minimum Attenuation	-30 0		dB dB
	Side Tone Attenuation Step Size		3		dB
f_{MCLK}	MCLK frequency	CLOCK_DIV = 0 CLOCK_DIV = 1	12.288 24.576		MHz MHz
	MCLK Duty Cycle		50	40 60	% (min) % (max)
f_{CONV}	Sampling Clock Frequency (Note 9)		48		kHz
f_{CLKSCL}	SCL_CLK Frequency		400		kHz
$t_{RISESCL}$	SCL_CLK, SCL_DATA Rise Time		300		ns
$t_{FALLSCL}$	SCL_CLK, SDA_DATA Fall Time		300		ns
t_{SDAH}	SDA_DATA Hold Time		500		ns
t_{SDAS}	SDA_DATA Setup Time		500		ns

Electrical Characteristics $DV_{DD} = 3.3V$, $AV_{DD} = 5V$, $R_{LHP} = 32\Omega$, $R_{LHF} = 8\Omega$

(Notes 1, 2, 8) (Continued)

The following specifications apply for the circuit shown in Figure 1, unless otherwise specified. Limits apply for $T_A = 25^\circ C$.

Symbol	Parameter	Conditions	LM4930		Units (Limits)
			Typical (Note 6)	Limits (Notes 7, 15)	
f_{CLKPCM}	PCM_CLK Frequency	PCM_SYNC_MODE = 00	128		kHz
		PCM_SYNC_MODE = 01	256		
		PCM_SYNC_MODE = 10	512		
	PCM_CLK Duty Cycle		50	40 60	% (min) % (max)
f_{CLKI2S}	I2S_CLK Frequency	I2S_RES = 0	1.536		MHz
		I2S_RES = 1	3.072		
	I2S_CLK Duty Cycle		50	40 60	% (min) % (max)

Electrical Characteristics $DV_{DD} = 3V$, $AV_{DD} = 3V$, $R_{LHP} = 32\Omega$, $R_{LHF} = 8\Omega$

(Notes 1, 2, 3)

The following specifications apply for the circuit shown in Figure 1, unless otherwise specified. Limits apply for $T_A = 25^\circ C$.

Symbol	Parameter	Conditions	LM4930		Units (Limits)
			Typical (Note 6)	Limits (Notes 7, 15)	
DI_{DD}	Digital Power Supply Current	$f_{MCLK} = 12.288MHz$ Output Mode = "0010" Output Mode = "0011" Output Mode = "0100"	1.6		
		Output Mode = "0101" Output Mode = "0110" Output Mode = "0111"	3.8		
		Output Mode = "1000" Output Mode = "1001" Output Mode = "1010"	4.2	7	mA (max)
AI_{DD}	Analog Power Supply Quiescent Current	$f_{MCLK} = 12.288MHz$; No Load			
		Output Mode = "0010"	5.8		
		Output Mode = "0011"	5.1		
		Output Mode = "0100"	6.5		
		Output Mode = "0101"	6.4		
		Output Mode = "0110"	5.8		
		Output Mode = "0111"	7.0		
	Output Mode = "1000" Output Mode = "1001" Output Mode = "1010"	7.5	12	mA (max)	
DI_{SD}	Digital Powerdown Current	$f_{MCLK} = 12.288MHz$ Output Mode = "0000" Powerdown Mode	1	7	μA (max)
AI_{SD}	Analog Powerdown Current	$f_{MCLK} = 12.288MHz$ Output Mode = "0000" Powerdown Mode	0.6	1.5	μA (max)
DI_{ST}	Digital Standby Current	$f_{MCLK} = 12.288MHz$ Output Mode = "0001" Standby Mode	1.1	1.7	mA (max)

Electrical Characteristics $DV_{DD} = 3V, AV_{DD} = 3V, R_{LHP} = 32\Omega, R_{LHF} = 8\Omega$

(Notes 1, 2, 3) (Continued)

The following specifications apply for the circuit shown in Figure 1, unless otherwise specified. Limits apply for $T_A = 25^\circ\text{C}$.

Symbol	Parameter	Conditions	LM4930		Units (Limits)
			Typical (Note 6)	Limits (Notes 7, 15)	
I_{ST}	Analog Standby Current	$f_{MCLK} = 12.288\text{MHz}$ Output Mode = "0001" Standby Mode	100	300	μA (max)
V_{FS_LS}	Full-Scale Output Voltage (Mono speaker amplifier)	CLASS = 0; 0dB gain setting; 8Ω BTL load (Note 10)	2.5		V_{P-P}
V_{FS_HP}	Full-Scale Output Voltage (Headphone amplifier)	0dB gain setting; 32Ω Stereo Load (Note 10)	2.5		V_{P-P}
V_{MIC_BIAS}	Mic Bias Voltage		2		V
THD+N	Headphone Amplifier Total Harmonic Distortion + Noise	$f_{IN} = 1\text{kHz}, P_{OUT} = 7.5\text{mW}$	0.07		%
P_{OHP}	Headphone Amplifier Output Power	THD+N = 0.5%, $f_{OUT} = 1\text{kHz}$	25	15	mW (min)
P_{OLS}	Mono Speaker Amplifier Output Power	THD+N = 1%, $f_{OUT} = 1\text{kHz}$	330	270	mW (min)
PSRR	Power Supply Rejection Ratio	$C_{BYPASS} = 1.0\mu\text{F}$ $C_{DAC_REF} = 1.0\mu\text{F}$ $V_{RIPPLE} = 200\text{mV}_{P-P} @ 217\text{Hz}$	50	42	dB (min)
SNR (Voice)	Signal-to-Noise Ratio (Voice DAC Path)	Signal = V_o at $f = 1\text{kHz}$ @1% THD+N, 32Ω Stereo Load; Noise = digital zero, A-weighted; 0dB gain setting	72		dB
SNR (Music)	Signal-to-Noise Ratio (Music Audio Path)	Signal = V_o at $f = 1\text{kHz}$ @1% THD+N, 32Ω Stereo Load; Noise = digital zero, A-weighted; 0dB gain setting	86		dB
DR (Voice)	Dynamic Range (Voice DAC Path)	Signal = V_o at $f = 1\text{kHz}$ @1% THD+N, 32Ω Stereo Load; Noise for -60dBFS digital input; A-weighted, 0dB gain setting	72		dB
DR (Music)	Dynamic Range (Music Audio Path)	Signal = V_o at $f = 1\text{kHz}$ @1% THD+N, 32Ω Stereo Load; Noise for -60dBFS digital input; A-weighted, 0dB gain setting	86		dB
SNR_{ADC}	Signal-to-Noise Ratio (Voice ADC Path)	Reference signal = 0dBFS MIC_P, MIC_N terminated with 10Ω to ground; A-weighted; 47dB MIC preamp gain setting	75		dB
DR_{ADC}	Dynamic Range (Voice ADC Path)	Reference signal = 0dBFS Noise for -60dBFS digital input; A-weighted; 47dB MIC preamp gain setting	75		dB
X_{TALK}	Stereo Channel-to-Channel Crosstalk	$f_s = 48\text{kHz}, f_{IN} = 1\text{kHz}$ sinewave at -3dB_{FS}	73		dB
V_{MIC-IN}	Maximum Differential MIC Input Voltage	17dB MIC Preamp gain setting	570		mV_{P-P}
R_{VDAC}	Voice DAC Ripple	300Hz - 3.3kHz through head-phone output.	+/-0.15	+/-0.2	dB (max)
R_{VADC}	Voice ADC Ripple	300Hz - 3.3kHz through head-phone output.	+/-0.25	+/-0.3	dB (max)
PB_{VDAC}	Voice DAC Passband	-3dB Point	3.46		kHz

Electrical Characteristics $V_{DD} = 3V$, $A_{V_{DD}} = 3V$, $R_{LHP} = 32\Omega$, $R_{LHF} = 8\Omega$

(Notes 1, 2, 3) (Continued)

The following specifications apply for the circuit shown in Figure 1, unless otherwise specified. Limits apply for $T_A = 25^\circ C$.

Symbol	Parameter	Conditions	LM4930		Units (Limits)
			Typical (Note 6)	Limits (Notes 7, 15)	
$SBA_{V_{DAC}}$	Voice DAC Stopband Attenuation	Above 4kHz	72		dB
$UPB_{V_{ADC}}$	Voice ADC Upper Passband Cutoff Frequency.	Upper -3dB Point	3.47		kHz
$LPB_{V_{ADC}}$	Voice ADC Lower Passband Cutoff Frequency.	Lower -3dB Point	0.230		kHz
$SBA_{V_{ADC}}$	Voice ADC Stopband Attenuation	Above 4kHz	65		dB
SBA_{NOTCH}	Voice ADC Notch Attenuation	Centered on 55Hz, figure gives worst case attenuation for 50Hz & 60Hz.	58		dB
R_{DAC}	Audio DAC Ripple	20Hz - 20kHz through head-phone output.	+/-0.1	+/-0.2	dB (max)
PB_{DAC}	Audio DAC Passband Width	-3dB point	22.7		kHz
SBA_{DAC}	Audio DAC Stopband Attenuation	Above 24kHz	76		dB
DR_{DAC}	Audio DAC Dynamic Range Digital Filter Section	Signal = VO at f = 1kHz @ 1% THD+N; f = 1kHz; Noise for -60dBFS digital input; 0dB gain; A-weighted	97		dB
SNR_{DAC}	Audio DAC SNR Digital Filter Section	Signal = VO at f = 1kHz @ 1% THD+N; f = 1kHz; Noise for -60dBFS digital input; 0dB gain; A-weighted	97		dB
ΔA_{CH-CH}	Stereo Channel-to-Channel Gain Mismatch		0.3		dB
V_{IL}	Digital Input: Logic Low Voltage Level		0.4		V
V_{IH}	Digital Input: Logic High Voltage Level		1.4		V
	Volume Control Range (Headphone amplifiers)	Maximum Attenuation Minimum Attenuation	-46.5 0		dB dB
	Volume Control Range (Mono speaker amplifier)	Minimum Gain Maximum Gain	-34.5 12		dB dB
	Volume Control Step Size (Output amplifiers)		1.5		dB
	Volume Control Range (Microphone Preamp)	Minimum Gain Maximum Gain	17 47		dB dB
	Volume Control Step Size (Microphone Preamp)		2		dB
	Side Tone Attenuation Range	Maximum Attenuation Minimum Attenuation	-30 0		dB dB
	Side Tone Attenuation Step Size		3		dB
f_{MCLK}	MCLK frequency	CLOCK_DIV = 0 CLOCK_DIV = 1	12.288 24.576		MHz MHz
	MCLK Duty Cycle		50	40 60	% (min) % (max)
f_{CONV}	Sampling Clock Frequency	(Note 9)	48		kHz
f_{CLKSCL}	SCL_CLK Frequency		400		kHz
$t_{RISESCL}$	SCL_CLK, SCL_DATA Rise Time		300		ns
$t_{FALLSCL}$	SCL_CLK, SDA_DATA Fall Time		300		ns
t_{SDAH}	SDA_DATA Hold Time		500		ns

Electrical Characteristics $DV_{DD} = 3V, AV_{DD} = 3V, R_{LHP} = 32\Omega, R_{LHF} = 8\Omega$

(Notes 1, 2, 3) (Continued)

The following specifications apply for the circuit shown in Figure 1, unless otherwise specified. Limits apply for $T_A = 25^\circ\text{C}$.

Symbol	Parameter	Conditions	LM4930		Units (Limits)
			Typical (Note 6)	Limits (Notes 7, 15)	
t_{SDAS}	SDA_DATA Setup Time		500		ns
f_{CLKPCM}	PCM_CLK Frequency	PCM_SYNC_MODE = 00	128		kHz
		PCM_SYNC_MODE = 01	256		kHz
		PCM_SYNC_MODE = 10	512		kHz
	PCM_CLK Duty Cycle		50	40 60	% (min) % (max)
f_{CLKI2S}	I2S_CLK Frequency	I2S_RES = 0	1.536		MHz
		I2S_RES = 1	3.072		MHz
	I2S_CLK Duty Cycle		50	40 60	% (min) % (max)

Note 1: Absolute Maximum Ratings indicate limits beyond which damage to the device may occur. Operating Ratings indicate conditions for which the device is functional but do not guarantee specific performance limits. Electrical Characteristics state DC and AC electrical specifications under particular test conditions which guarantee specific performance limits. This assumes that the device is within the Operating Ratings. Specifications are not guaranteed for parameters where no limit is given, however, the typical value is a good indication of device performance.

Note 2: All voltages are measured with respect to the relevant GND pin unless otherwise specified.

Note 3: The maximum power dissipation must be derated at elevated temperatures and is dictated by T_{JMAX}, θ_{JA} , and the ambient temperature, T_A . The maximum allowable power dissipation is $P_{DMAX} = (T_{JMAX} - T_A) / \theta_{JA}$ or the number given in Absolute Maximum Ratings, whichever is lower. For the LM4930, see power derating currents for more information.

Note 4: Human body model: 100pF discharged through a 1.5k Ω resistor.

Note 5: Machine model: 220pF - 240pF discharged through all pins.

Note 6: Typicals are measured at 25°C and represent the parametric norm.

Note 7: Limits are guaranteed to National's AOQL (Average Outgoing Quality Level).

Note 8: Best operation is achieved by maintaining $3.0V \leq AV_{DD} \leq 5.0$ and $3.0V \leq DV_{DD} \leq 3.6V$. AV_{DD} must be equal to or greater than DV_{DD} , for proper operation.

Note 9: The sampling clock frequency is equal to the master clock frequency divided by 256. ($f_{conv} = f_{MCLK}/256$)

Note 10: This value represents the 0dB output level of the given amplifier for the given analog supply voltage. Gain values given in the GAINCONFIG register are relative to these full-scale values for each output amplifier.

Note 11: To ensure a successful transition into Powerdown Mode, ZXD_DISABLE must be set whenever there is no audio input signal present.

Note 12: It is recommended to alter this bit only while the part is in Powerdown Mode.

Note 13: Reserved bits should be set to zero when programming the associated register.

Note 14: With the exception of Standby Mode, rapid switching between modes should be avoided. Rapid switching between modes will not ensure that the desired mode will be activated.

Note 15: Datasheet min/max specification limits are guaranteed by design, test, or statistical analysis.

Note 16: 0dBm0 = -3dBFS for the PCM voice codec and 0dBm0 = -1dBFS for the I²S DAC, unless otherwise specified.

Note 17: The given θ_A is for an LM4930 packaged in an LQA44A with the Exposed-DAP soldered to an exposed 2in² area of 1oz printed circuit board copper with 16 thermal vias as described in National AN-1187.

Typical Performance Characteristics (Note 16)

MIC PreAmp + ADC Frequency Response (MIC Gain = 17dB)

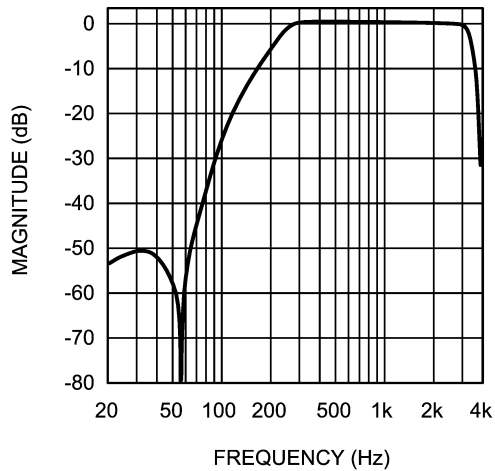

20072015

MIC PreAmp + ADC Frequency Response Zoom (MIC Gain = 17dB)

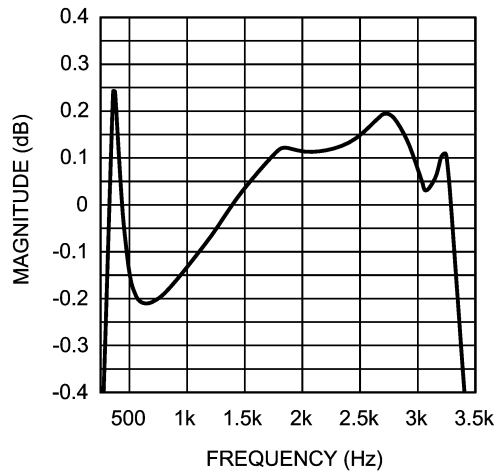

20072016

MIC PreAmp + ADC Frequency Response (MIC Gain = 47dB)

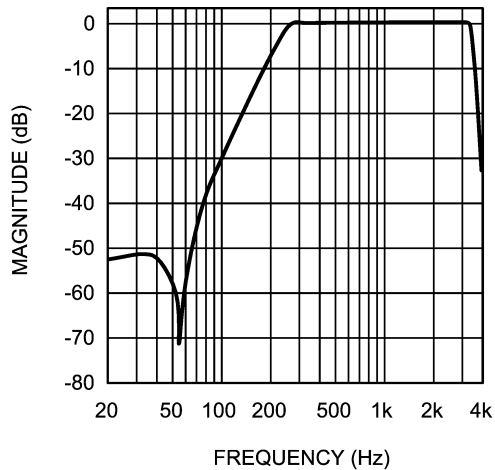

20072017

MIC PreAmp + ADC Frequency Response Zoom (MIC Gain = 47dB)

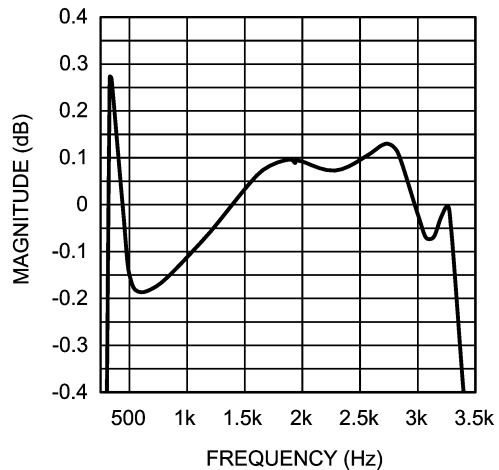

20072018

MIC PreAmp + ADC Frequency Response High Cutoff (MIC Gain = 17dB)

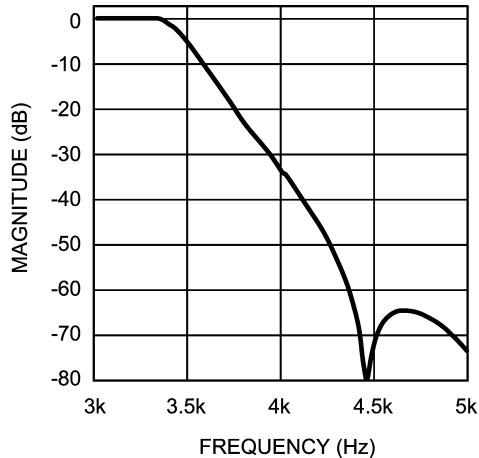

20072019

MIC PreAmp + ADC Frequency Response High Cutoff (MIC Gain = 47dB)

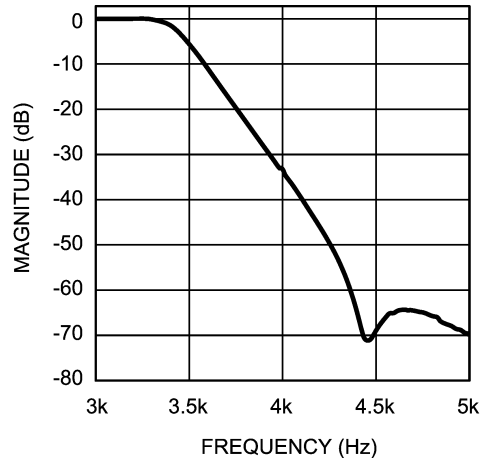

20072020

Typical Performance Characteristics (Note 16) (Continued)

MIC PreAmp + ADC Frequency Response Low Cutoff
(MIC Gain = 17dB)

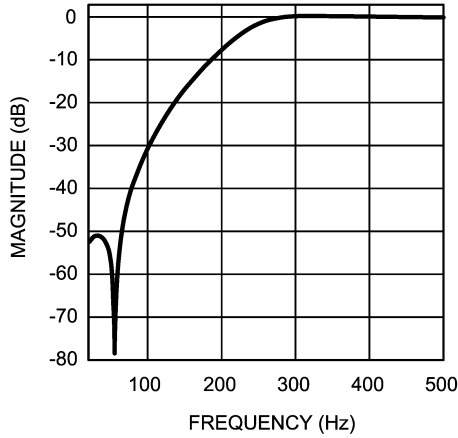

MIC PreAmp + ADC Frequency Response Low Cutoff
(MIC Gain = 47dB)

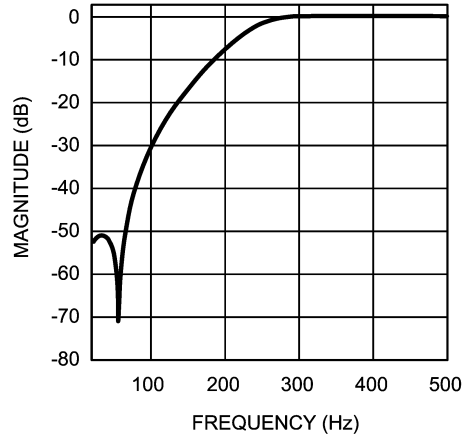

ADC THD+N vs MIC Input Voltage
(MIC Gain = 17dB)

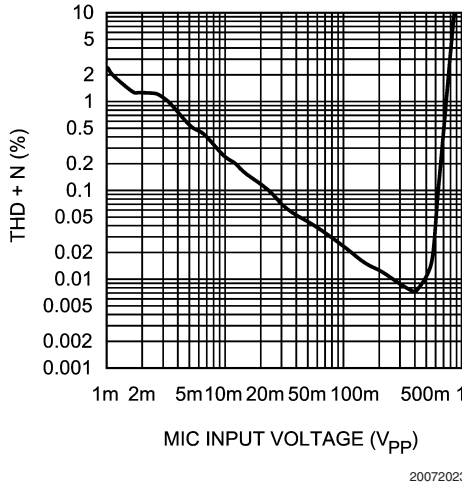

ADC THD+N vs MIC Input Voltage
(MIC Gain = 47dB)

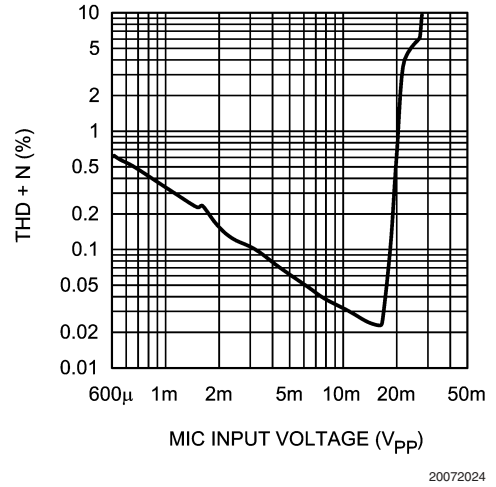

MIC PreAmp + ADC PSRR vs Frequency
Top Trace = 47dB MIC Gain, Bottom Trace = 17dB MIC Gain

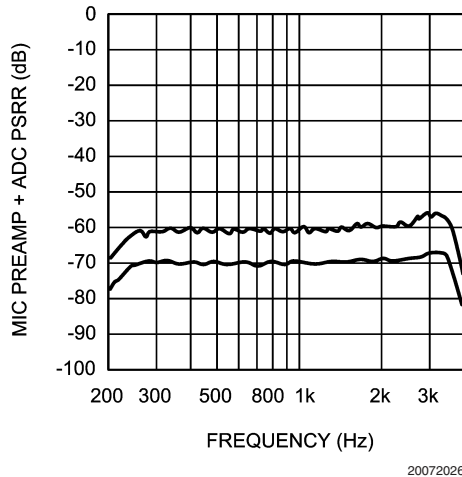

Headphone Sense In Hysteresis Loop
(AV_{DD} = 3V)

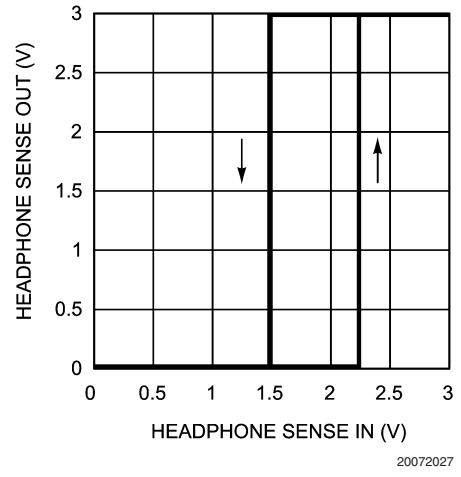

Typical Performance Characteristics (Note 16) (Continued)

Headphone Sense In Hysteresis Loop
($AV_{DD} = 5V$)

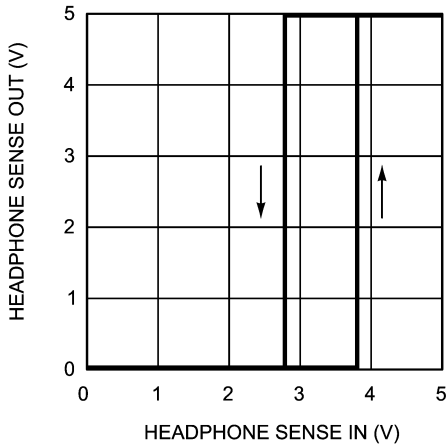

20072028

I²S DAC Frequency Response
(Handsfree Output)

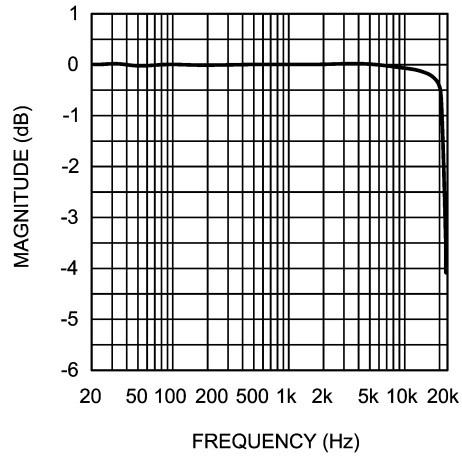

20072029

I²S DAC Frequency Response Zoom
(Handsfree Output)

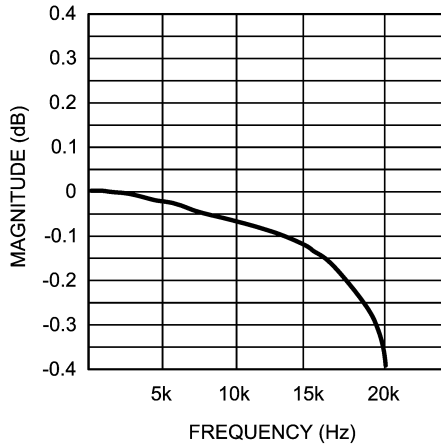

20072030

I²S DAC Frequency Response Zoom
(Headphone Output)

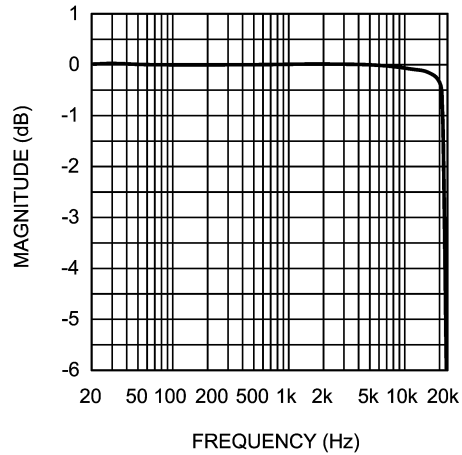

20072031

I²S DAC Frequency Response Zoom
(Headphone Output)

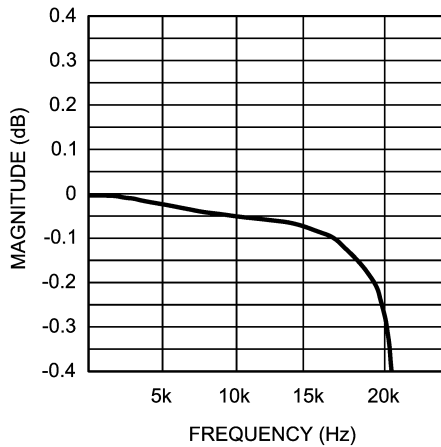

20072032

THD+N vs I²S Input Voltage
(Handsfree Output, 0dB Handsfree Gain)

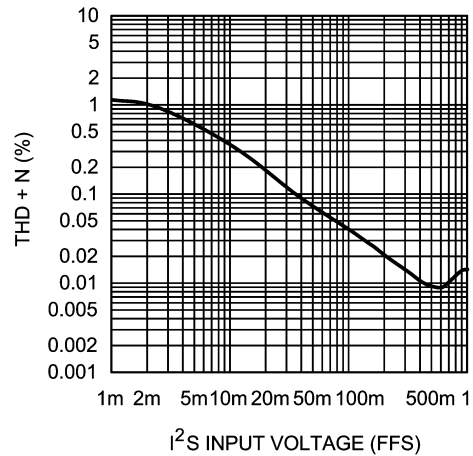

20072038

Typical Performance Characteristics (Note 16) (Continued)

THD+N vs I²S Input Voltage
(Headphone Output, 0dB Headphone Gain)

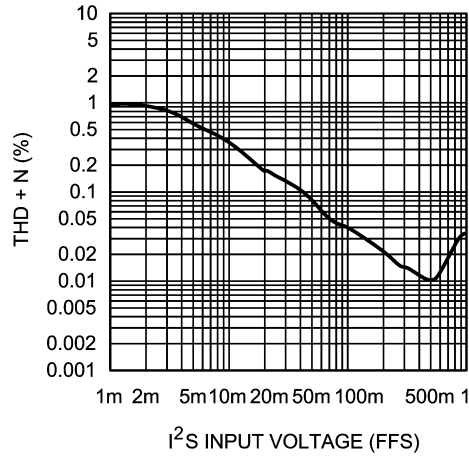

I²S DAC Crosstalk
(Top Trace = Left to Right, Bottom Trace = Right to Left)

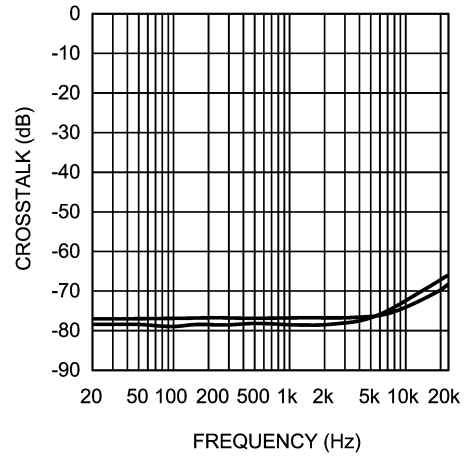

MIC Bias Dropout Voltage vs MIC Bias Current

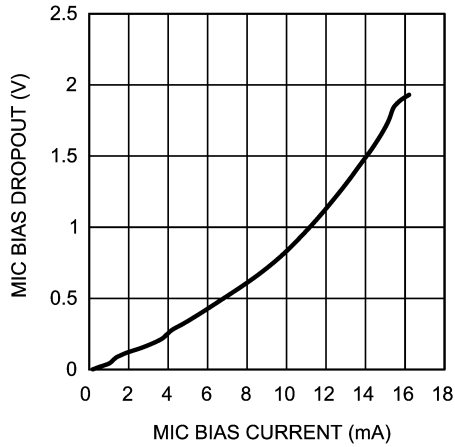

PCM DAC Frequency Response (Handsfree Output)

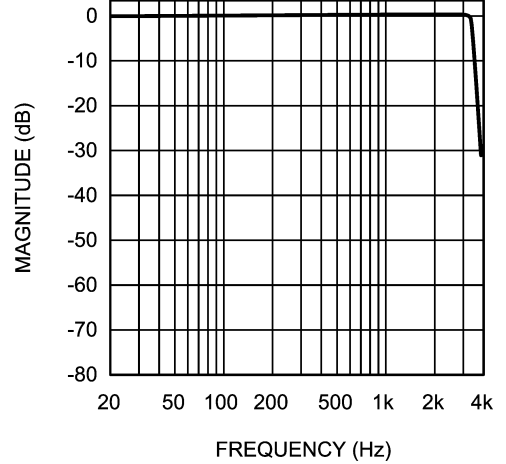

PCM DAC Frequency Response Zoom (Handsfree Output)

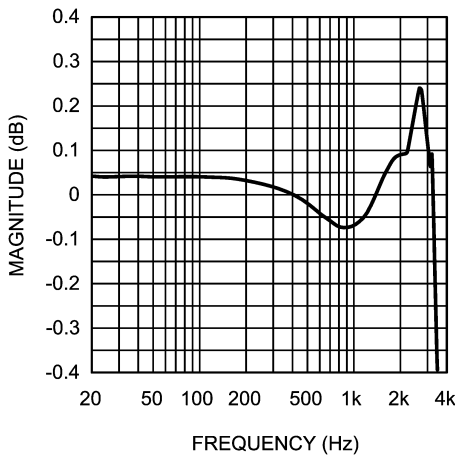

PCM DAC Frequency Response (Headphone Output)

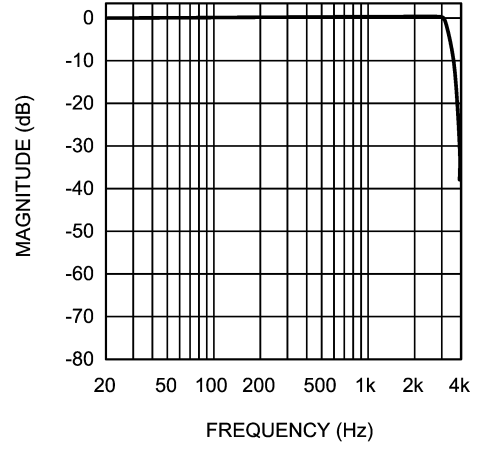

Typical Performance Characteristics (Note 16) (Continued)

PCM DAC Frequency Response Zoom
(Headphone Output)

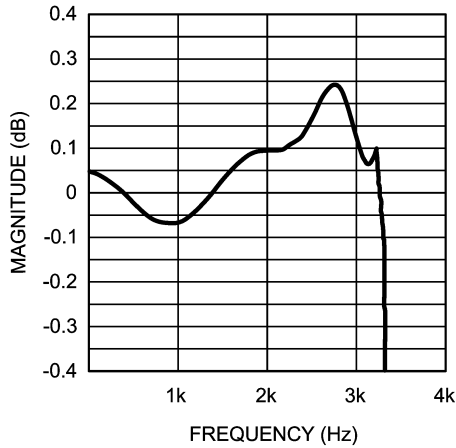

20072051

THD+N vs PCM Input Voltage
(Handsfree Output, 0dB Handsfree Gain)

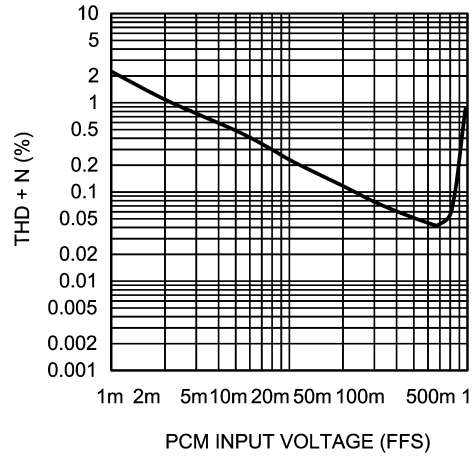

20072052

THD+N vs PCM Input Voltage
(Headphone Output, 0dB Headphone Gain)

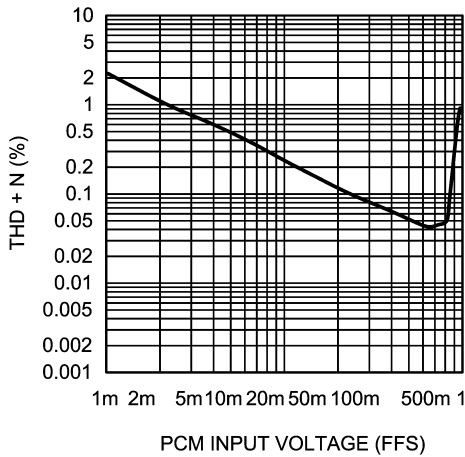

20072053

Crosstalk
(AV_{DD} = 5V and AV_{DD} = 3V, Headphone Output)

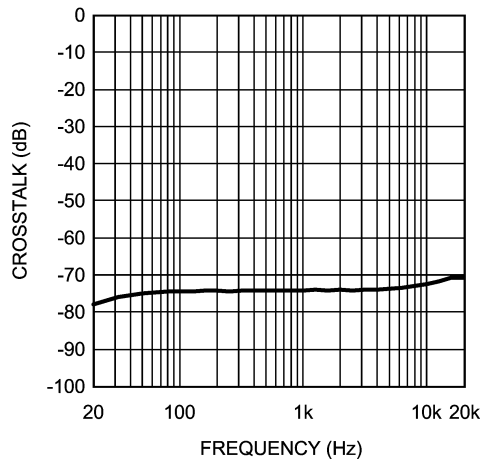

200720F9

PSRR vs Frequency
(AV_{DD} = 3V, R_L = 16Ω, Headphone Output)

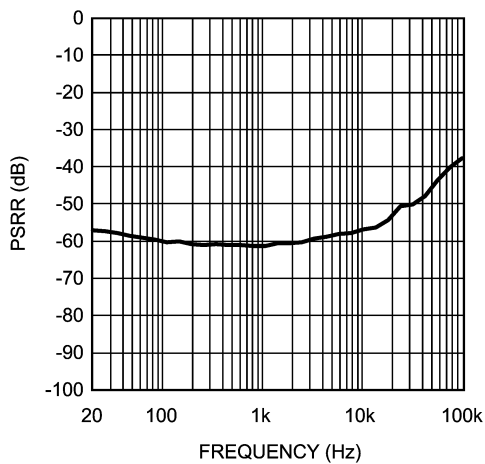

200720G0

PSRR vs Frequency
(AV_{DD} = 3V, R_L = 32Ω, Headphone Output)

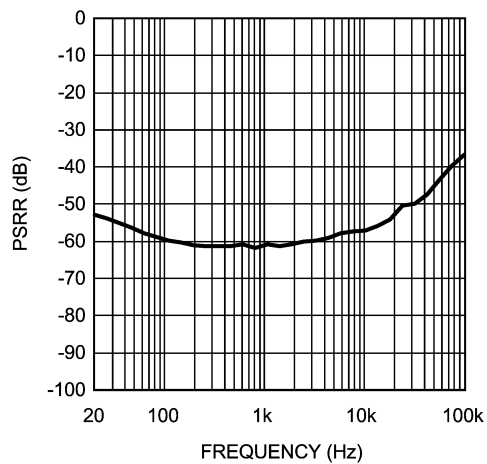

200720G1

Typical Performance Characteristics (Note 16) (Continued)

PSRR vs Frequency
($AV_{DD} = 3V, R_L = 8\Omega, \text{Handsfree Output}$)

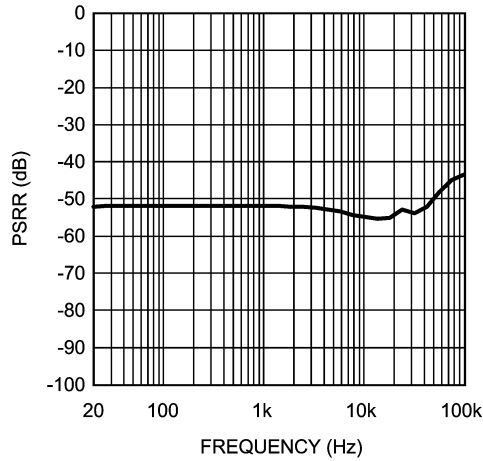

200720G2

PSRR vs Frequency
($AV_{DD} = 5V, R_L = 16\Omega, \text{Headphone Output}$)

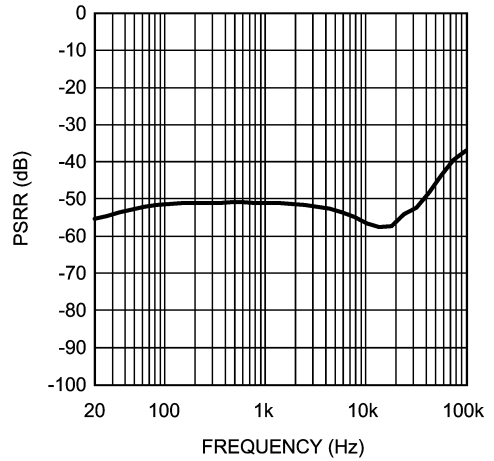

200720G3

PSRR vs Frequency
($AV_{DD} = 5V, R_L = 32\Omega, \text{Headphone Output}$)

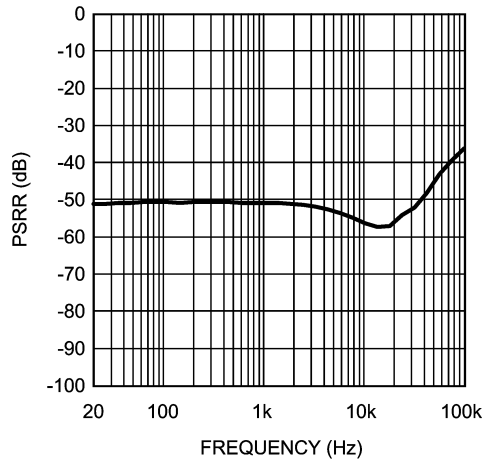

200720G4

PSRR vs Frequency
($AV_{DD} = 5V, R_L = 8\Omega, \text{Handsfree Output}$)

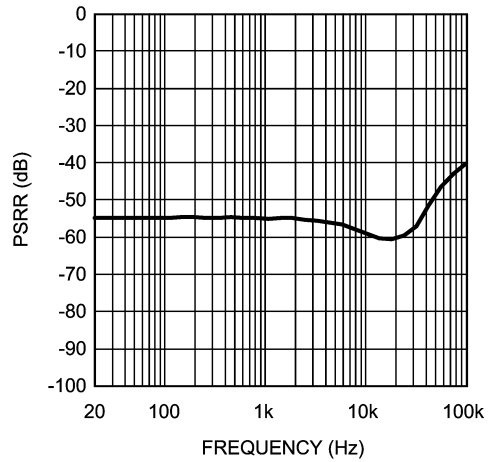

200720G5

THD+N vs Frequency
($AV_{DD} = 3V, R_L = 8\Omega, P_O = 150mW, \text{Handsfree Output}$)

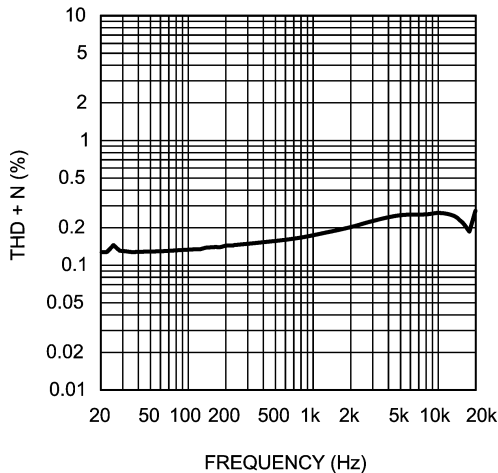

20072001

THD+N vs Frequency
($AV_{DD} = 5V \text{ and } AV_{DD} = 3V, R_L = 16\Omega, P_O = 15mW, \text{Headphone Output}$)

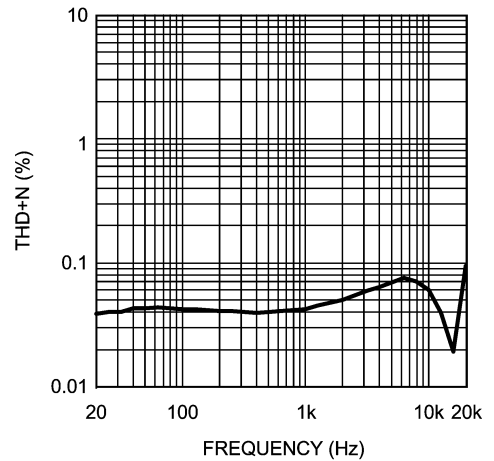

200720G7

Typical Performance Characteristics (Note 16) (Continued)

THD+N vs Frequency
 ($AV_{DD} = 5V$ and $AV_{DD} = 3V$, $R_L = 32\Omega$, $P_O = 7.5mW$,
 Headphone Output)

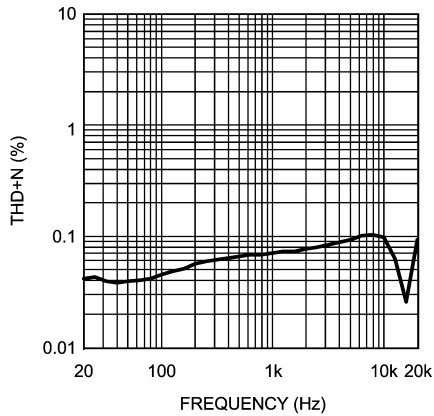

200720G8

THD+N vs Frequency
 ($AV_{DD} = 5V$, $R_L = 8\Omega$, $P_O = 250mW$, Handsfree Output)

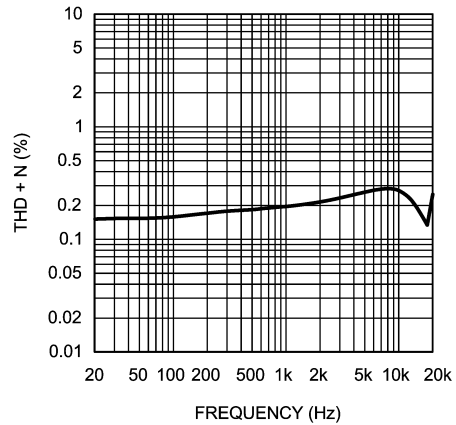

20072025

THD+N vs Output Power
 ($AV_{DD} = 3V$, $R_L = 16\Omega$, $f = 1kHz$, Headphone Output)

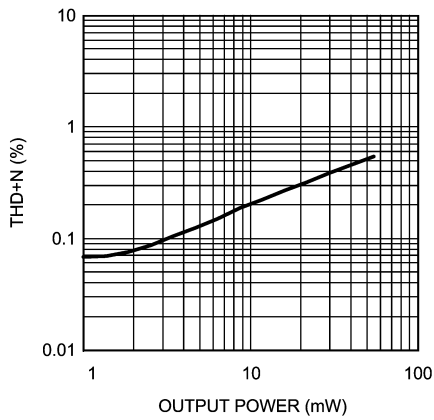

200720H0

THD+N vs Output Power
 ($AV_{DD} = 3V$, $R_L = 8\Omega$, $f = 1kHz$, Handsfree Output)

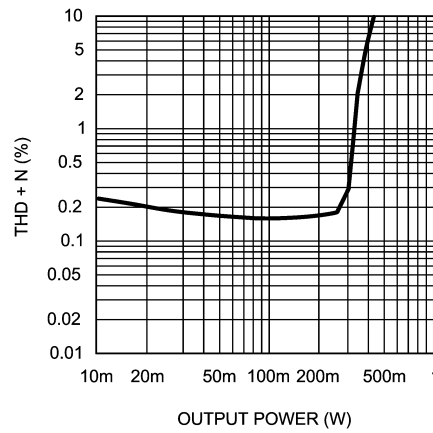

20072033

THD+N vs Output Power
 ($AV_{DD} = 5V$ and $AV_{DD} = 3V$, $R_L = 32\Omega$, $f = 1kHz$,
 Headphone Output)

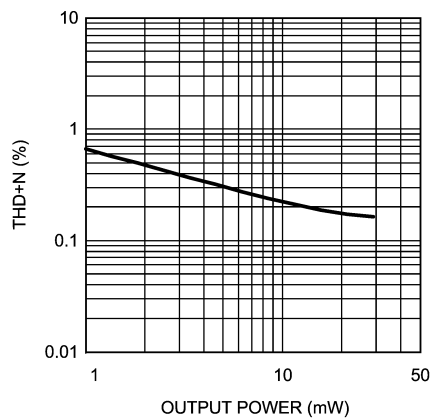

200720H3

THD+N vs Output Power
 ($AV_{DD} = 5V$ and $AV_{DD} = 3V$, $R_L = 16\Omega$, $f = 1kHz$,
 Headphone Output)

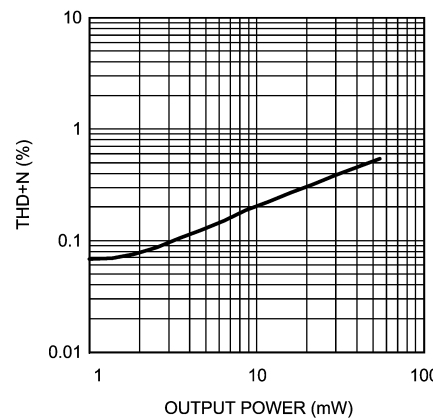

200720H4

Typical Performance Characteristics (Note 16) (Continued)

THD+N vs Output Power
 ($AV_{DD} = 5V, R_L = 8\Omega, f = 1kHz, \text{Handsfree Output}$)

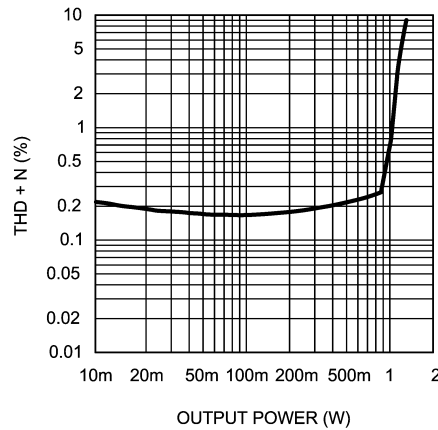

20072034

Application Information

REFERENCE DESIGN BOARD AND LAYOUT

LM4930ITL Board Layout

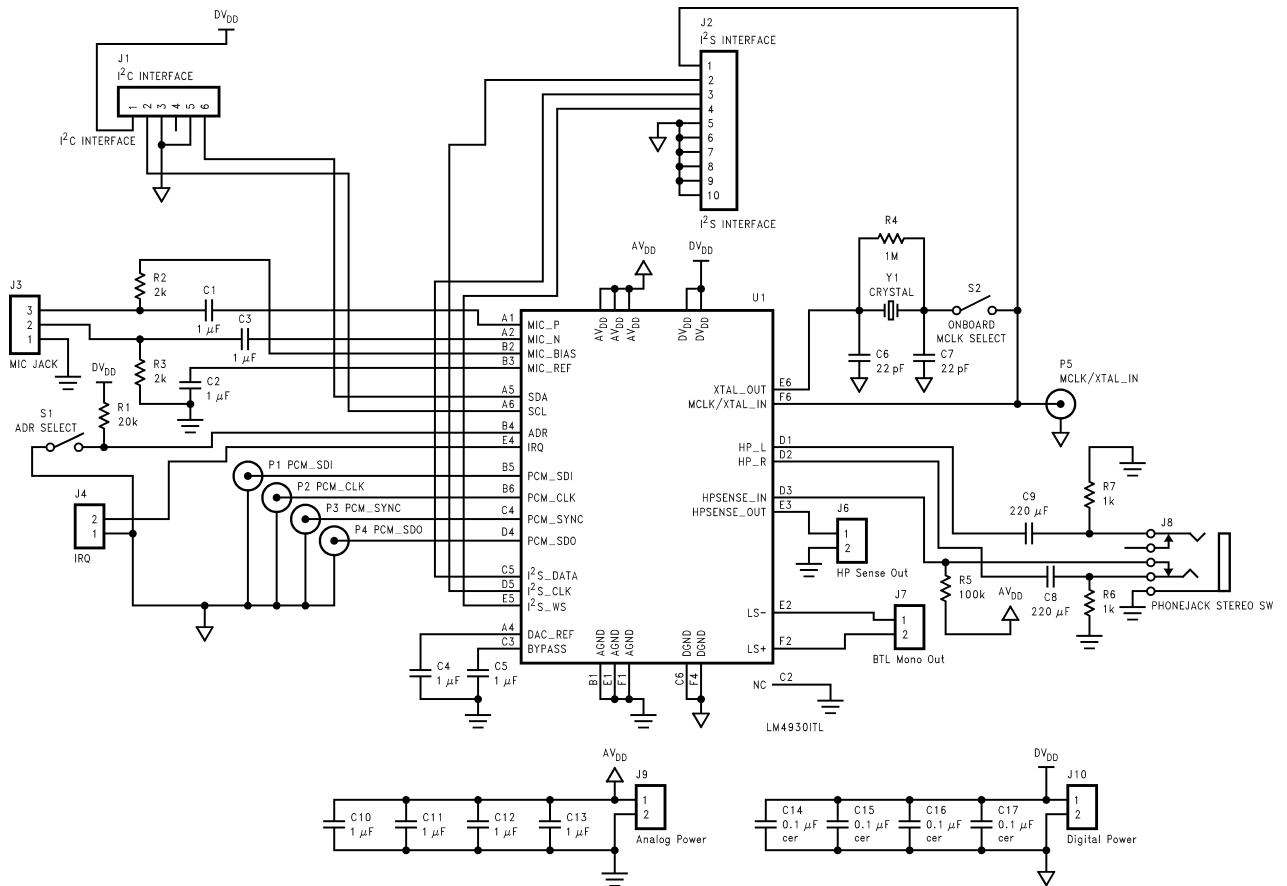

20072014

FIGURE 5. LM4930ITL Demo Board Schematic

Application Information (Continued)

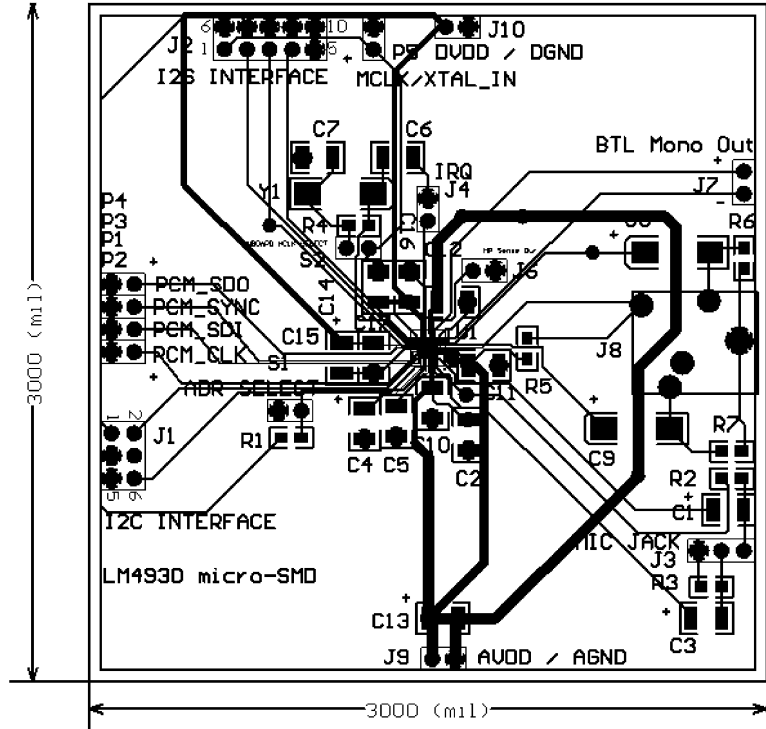

20072006

FIGURE 6. LM4930ITL Demo Board Composite View

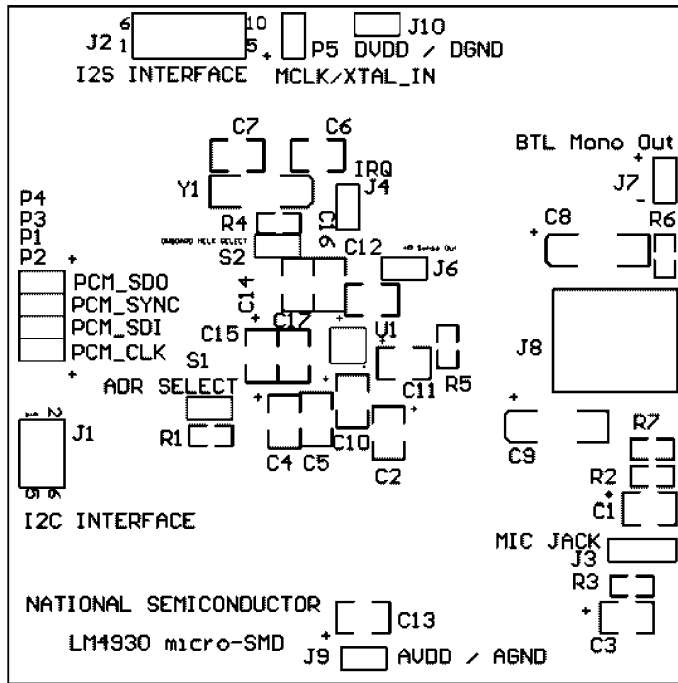

20072005

FIGURE 7. LM4930ITL Demo Board Silkscreen

Application Information (Continued)

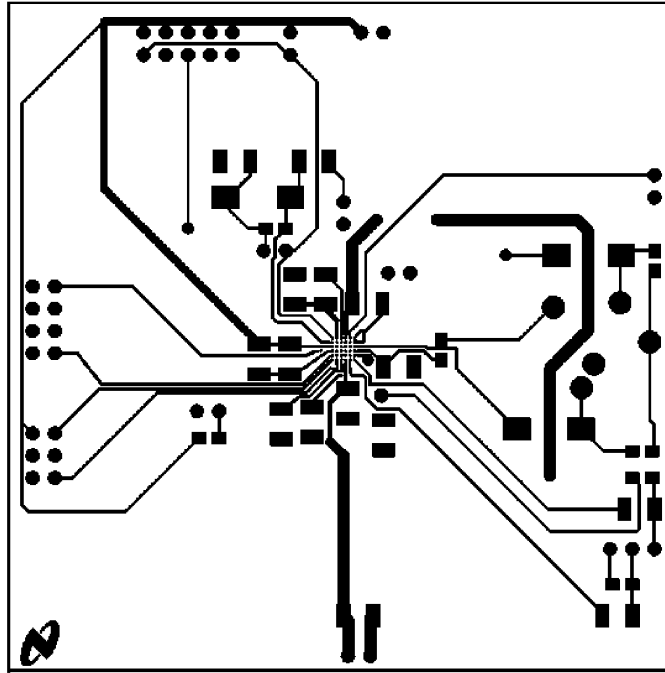

20072004

FIGURE 8. LM4930ITL Demo Board Top Layer

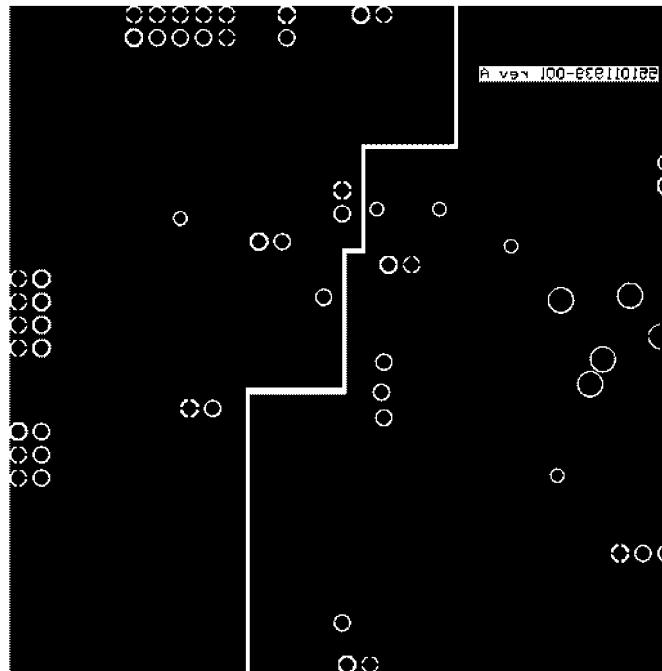

20072013

FIGURE 9. LM4930ITL Demo Board Bottom Layer

Application Information (Continued)

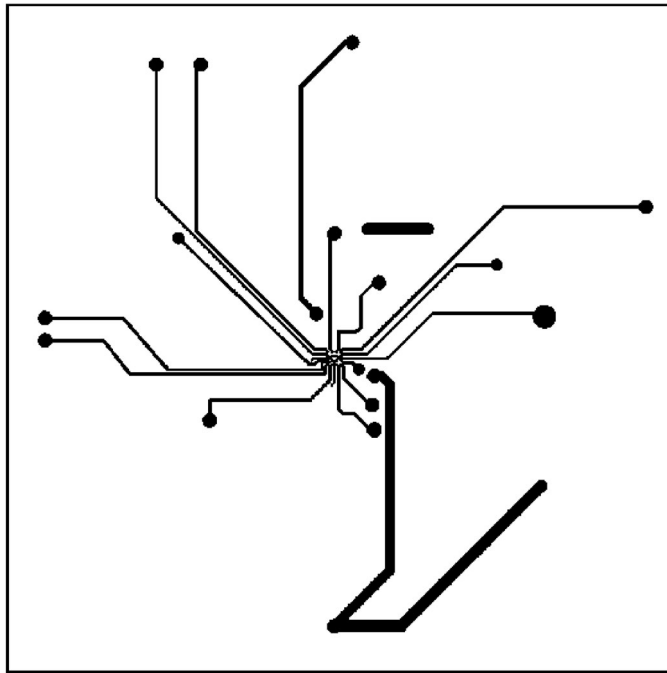

20072012

FIGURE 10. LM4930ITL Demo Board Inner Layer 1

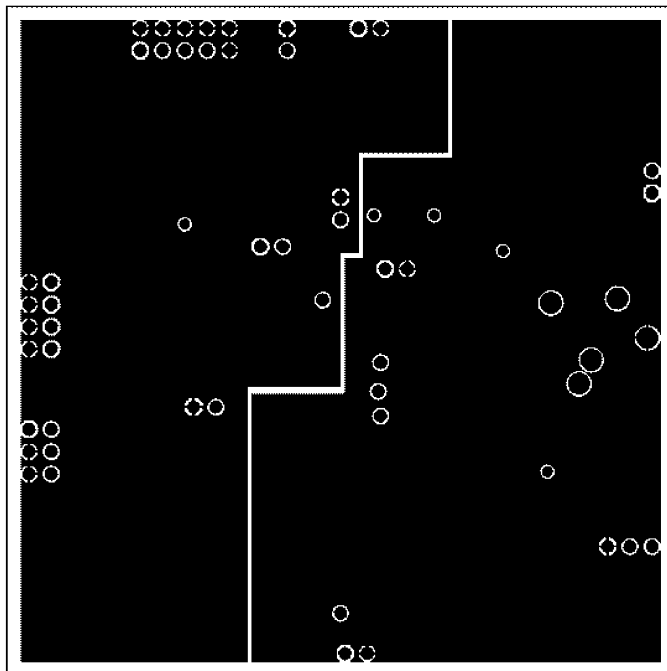

20072011

FIGURE 11. LM4930ITL Demo Board Inner Layer 2

Application Information (Continued)

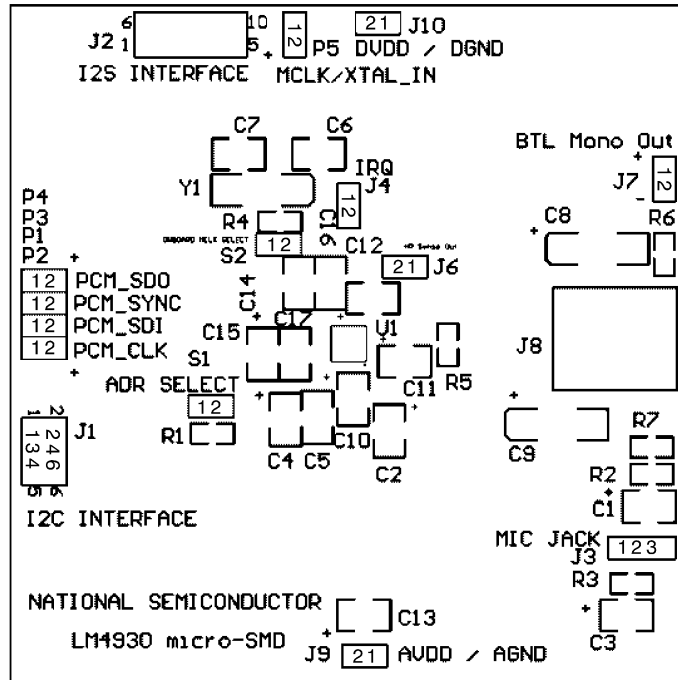

20072010

FIGURE 12. Pin Markings for LM4930ITL demo board

BILL OF MATERIALS FOR LM4930

LM4930 Demo Board Bill Of Materials

Comment	Footprint	Designators
1k	0805	R6, R7
2k	0805	R2, R3
20k	0805	R1
100k	0805	R5
1M	0805	R4
22pF	1210	C6, C7
0.01 μ F cer	1210	C16, C17
0.1 μ F cer	1210	C14, C15
1 μ F	1210	C1, C2, C3, C4, C5, C10, C11, C12, C13
220 μ F	7243	C8, C9
CRYSTAL	7243	Y1
PHONE JACK STEREO SW STEREO HEADPHONE JACK (3.5MM) J8		

Application Information (Continued)**Two-wire control Interface (J1)**

Pin	Function
1	DVDD
2	SCL
3	DGND
4	NC
5	DGND
6	SDA

PCM Interface (P4, P3, P1, P2)

Header	Function
P1	PCM_SDI
P2	PCM_CLK
P3	PCM_SYNC
P4	PCM_SDO

I2S Interface (J2)

Pin	Function
1	MCLK
2	I2S-CLK
3	I2S-DATA
4	I2S-WS
5	DGND
6	DGND
7	DGND
8	DGND
9	DGND
10	DGND

MIC Jack

Pin	Function
1	AGND
2	MIC-
3	MIC+

**Misc Jumpers and Headers
DVDD/DGND (J10)**

Pin	Function
1	DGND
2	AVDD

**Misc Jumpers and Headers
AVDD/AGND (J9)**

Pin	Function
1	AGND
2	AVDD

**Misc Jumpers and Headers
MCLK/XTAL_IN (P5)**

Pin	Function
-----	----------

Application Information (Continued)

Misc Jumpers and Headers MCLK/XTAL_IN (P5) (Continued)

1	DGND
2	MCLK/XTAL_IN

ADR SELECT (S1)

Jumper IN = LOW

Control interface responds to addresses 001000b (BASICCONFIG), 0010001b (VOICETESTCONFIG), and 0010010b (GAIN-CONFIG)

Jumper OUT = HIGH

Control interface responds to addresses 111000b (BASICCONFIG), 1110001b (VOICETESTCONFIG), and 1110010b (GAIN-CONFIG)

HP Sense Out (J6)

Pin	Function
1	AGND
2	HPSense_Out

IRQ (J4)

Pin	Function
1	DGND
2	IRQ

Onboard MCLK Select (S2)

Jumper IN = Onboard MCLK

Jumper OUT = External MCLK

LM4930ITL DEMO BOARD OPERATION

The LM4930ITL demo board is a complete evaluation platform, designed to give easy access to the control pins of the part and comprise all the necessary external passive components. Besides the separate analog (J9) and digital (J10) supply connectors, the board features seven other major input and control blocks: a two wire interface bus (J1) for the control lines, a PCM interface bus (P1-P4) for voiceband digital audio, an I2S interface bus (J2) for full-range digital audio, an analog mic jack input (J3) for connection to an external microphone, a BTL mono output (J7) for connection to an external speaker, a stereo headphone output (J8), and an external MCLK input (P5) for use in place of the crystal on the demoboard.

Two-wire Interface Bus (J1)

This is the main control bus for the LM4930. It is a two-wire interface with an SDA line (data) and SCL line (clock). Each transmission from the baseband controller to the LM4930 is given MSB first and must follow the timing intervals given in the Electrical Characteristics section of the datasheet to create the start and stop conditions for a proper transmission. The start condition is detected if SCL is high on the falling edge of SDA. The stop condition is detected if SCL is high on the rising edge of SDA. Repeated start signals are handled correctly. Data is then transmitted as shown in Figure 2. After the start condition has been achieved the chip address is sent, followed by a set write bit, wait for ack (SDA will be pulled low by LM4930), data bits 15-8, wait for ACK (SDA will be pulled low by LM4930), data bits 7-0, wait for ACK (SDA will be pulled low by LM4930) and finally the stop condition is given.

This same sequence follows for any control bus transmission to the LM4930. The chip address is hardwire selected by the ADR Select pin which may be jumpered high or low with its application at S1 on the demo board. The chip address is then given as a combination of the identifying bits for the LM4930 plus the 2-bit address of the desired control register (00b = BasicConfig, 01b = VoicetestConfig, 10b = GainConfig). Acceptable addresses are shown here in Table 1.

Table 1. LM4930 Control Bus Addresses

Address Bits							Register Address
ADR = 0							
6	5	4	3	2	1	0	
0	0	1	0	0	0	0	0
0	0	1	0	0	0	0	1
0	0	1	0	0	1	0	
ADR = 1							
1	1	1	0	0	0	0	
1	1	1	0	0	0	1	
1	1	1	0	0	1	0	

Data is sampled only if the address is in range and the R/W bit is clear. Data for each register is given in the System Control Registers section of the datasheet. National Semiconductor also features a special control board for quick evaluation of the LM4930 demo board with your PC. This is a serial control interface board, complete with header com-

Application Information (Continued)

patible with the interface header (J1) on the LM4930 board. This also features demonstration software to allow for complete control and evaluation of the various modes and functions of the LM4930 through the bus.

Pullup resistors are required to achieve reliable operation. 750Ω pullup resistors on the SDA and SCL lines achieves best results when used with National's parallel-to-serial interface board. Lower value pullup resistors will decrease the rise and fall times on the bus which will in turn decrease susceptibility to bus noise that may cause a false trigger. The cost comes at extra current use. Control bus reliability will thus depend largely on bus noise and may vary from design to design. Low noise is critical for reliable operation.

PCM Bus Interface (P1, P2, P3, P4)

PCM_SDO (P4), PCM_SYNC (P3), PCM_SDI (P1), and PCM_CLK (P2) form the PCM interface bus for simple communication with most baseband ICs with voiceband communications and follow the PCM-1900 communications standard. The PCM interface features frame lengths of 16, 32, or 64 bits, A-law and u-law companding, linear mode, short or long frame sync, an energy-saving power down mode, and master only operation.

The PCM bus does not support a slave mode. It operates as a master only. Thus PCM_SYNC and PCM_CLK are solely generated by the LM4930. PCM_SYNC is the word sync line for the bus. It operates at a fixed frequency of 8kHz and may be set in the BASICCONFIG register (bit 5 PCM_LONG) for short or long frame sync. A short frame sync is 1 PCM_CLK cycle (PCM_LONG=0), a long frame sync is 2 PCM_CLK cycles long (PCM_LONG=1). A long sync pulse is also delayed one clock cycle relative to a short sync pulse. This is illustrated in Figure 3. PCM_CLK is the bit clock for the bus. Its frequency depends on the number of 16-bit frames per sync pulse and can be 128kHz, 256kHz, 512kHz.

The other two lines, PCM_SDO and PCM_SDI, are for serial data out and serial data in, respectively. The type of data may also be set in the BASICCONFIG register by bits 6 and 7. Bit 6 controls whether the data is linear or companded. If set to 1, the 8 MSBs are presumed to be companded data and the 8 LSBs are ignored. If cleared to 0, the data is treated as 2's complement PCM data. Bit 7 controls which PCM law is used if Bit 6 is set for companded (G711) data. If set to 1, the companded data is assumed to be A-law. If cleared to 0, the companded data is treated as μ-law.

Bits 8:9 of the BASICCONFIG register set the PCM_SYNC_MODE settings. This controls the number of 16 bit frames per sync pulse. The feature allows the LM4930 to function harmoniously with other devices or channels on the PCM bus by adjusting the number of 16 bit frames per sync pulse to 1 (00b), 2 (01b), or 4 (10b). The LM4930 will transmit PCM data in the first frame and then tri-state the PCM_SDO pin on later frames.

In addition, the LM4930 provides control to allow the PCM_CLK and PCM_SYNC clocks to continue functioning even when the LM4930 is in Standby mode. By setting bit 10 of the BASICCONFIG register to 1 PCM_ALWAYS_ON is enabled and the LM4930 will continue to drive the PCM clock and sync lines when in Standby mode. This bit should be set if another codec is using the PCM bus. Powerdown mode will disable these outputs.

I2S Interface Bus (J2)

The I2S standard provides a uni-directional serial interface designed specifically for digital audio. For the LM4930, the interface provides access to a 48kHz, 16 bit full-range stereo audio DAC. This interface uses a three port system of clock (I2S_CLK), data (I2S_DATA), and word (I2S_WS). The clock and word lines can be either master or slave as set by bit 11 in the BASICCONFIG register.

A bit clock (I2S_CLK) at 32 or 64 times the sample frequency is established by the I2S system master and a word select (I2S_WS) line is driven at a frequency equal to the sampling rate of the audio data, in this case 48kHz. The word line is registered to change on the negative edge of the bit clock. The serial data (I2S_DATA) is sent MSB first, again registered on the negative edge of the bit clock, delayed by 1 bit clock cycle relative to the changing of the word line (typical I2S format - see Figure 4).

The resolution of the I2S interface may be set by modifying the I2S_RES bit (bit 12) in the BASICCONFIG register. If set to 1, the LM4930 operates at 32 bits per frame (3.072MHz). If cleared to 0, then 16 bits per frame is selected (1.536MHz). This has a corresponding effect on the bit clock.

The I2S Interface Bus also provides for an additional MCLK connection to an external device from the LM4930 demo board. This may be used in conjunction with National Semiconductors SPDIF->I2S Conversion Board for quick evaluation. This board features a connection header that interfaces with pins 1-5 of the I2S Interface Bus. Pins 6-10 are provided as digital ground references for the case of discrete connections.

MCLK/XTAL_IN (P5)

This is the input for an external Master Clock. The jumper at S2 must be removed (disconnecting the onboard crystal from the circuit) when using an external Master Clock.

BTL Mono Out (J7)

This is the mono speaker output, designed for use with an 8 ohm speaker. The outputs are driven in bridge-tied-load (BTL) mode, so both sides have signal. Outputs are normally biased at one half AVDD when the LM4930 is in active mode.

Additionally, if the CLASS bit is set to 1 in the VOICETEST-CONFIG register (bit 0) the BTL mono output is internally configured as a buffer amplifier designed for use with an external class D amp.

Stereo Headphone Out (J8)

This is the stereo headphone output. Each channel is single-ended, with 220uF DC blocking capacitors mounted on the demo board. The jack features a typical stereo headphone pinout.

A headphone sense pin is provided at J6. This pin provides a clean logic high or low output to indicate the presence of headphones in the headphone jack. A common application circuit for this is given in the Reference Board Schematic shown in Figure 5. In this application HPSENSE_IN is pulled low by the 1k ohm resistor when no headphone is present. This gives a corresponding logic low output on the HPSENSE_OUT pin. When a headphone is placed in the jack the 1k ohm pull-down is disconnected and a 100k ohm pull-up resistor creates a high voltage condition on HPSENSE_IN. This in turn creates a logic high on HPSENSE_OUT. This output may be used to reliably drive an external microcontroller with headphone status.

Application Information (Continued)

MIC Jack (J3)

This jack is for connection to an external microphone like the kind typically found in mobile phones. Pin 1 is GND, pin 2 is the negative input pin, and pin 3 is the positive pin, with phantom voltage supplied by MIC_BIAS on the LM4930.

IRQ (J4)

This pin provides simple status updates from the LM4930 to an external microcontroller if desired. IRQ is logic high when the LM4930 is in a stable state and changes to low when changing modes. This can also be useful for simple software/driver development to monitor mode changes, or as a simple debugging tool.

BASIC OPERATION

The LM4930 is a highly integrated audio subsystem with many different operating modes available. These modes may be controlled in the BASICCONFIG register in bits 3:0. These mode settings are shown in the BASICCONFIG register table and are described here below:

Powerdown Mode (0000b)

Part is powered down, analog outputs are not biased. This is a minimum current mode. All part features are shut down.

Standby Mode (0001b)

The LM4930 is powered down, but outputs are still biased at one half AVDD. This comes at some current cost, but provides a much faster turn-on time with zero "click and pop" transients on the headphone out. Standby mode can be toggled into and out of rapidly and is ideal for saving power whenever continuous audio is not a requirement. All other part functions are suspended unless PCM_ALWAYS_ON (bit 10 in BASICCONFIG register) is enabled, in which case PCM_CLK and PCM_SYNC will continue to function.

Mono Speaker Mode (0010b)

Part is active. All analog outputs are biased. Audio from the voiceband codec is routed to the mono speaker out. Stereo headphone out is silent.

Headphone Call Mode (0011b)

Part is active. All analog outputs are biased. Audio from voiceband codec is routed to the stereo headphones. Both left and right channels are the same. Mono speaker out is silent.

Conference Call Mode (0100b)

Part is active. All analog outputs are biased. Audio from the voiceband codec is routed to the mono speaker out and to the stereo headphones.

L+R Mixed to Mono Speaker (0101b)

Part is active. All analog outputs are biased. Full-range audio from the 16bit/48kHz audio DAC is mixed together and routed to the mono speaker out. Stereo headphones are silent.

Headphone Stereo Audio (0110b)

Part is active. All analog outputs are biased. Full-range audio from the 16bit/48kHz audio DAC is sent to the stereo headphone jack. Each channel is heard discretely. The mono speaker is silent.

L+R Mixed to Mono Speaker + Stereo Headphone Audio (0111b)

Part is active. All analog outputs are biased. Full-range audio from the 16bit/48kHz audio DAC is sent discretely to the stereo headphone jack and also mixed together and sent to the mono speaker out.

Mixed Mode (1000b)

Part is active. All analog outputs are biased. This provides one channel (the left channel) of full range audio to the mono speaker out. Audio from the voiceband codec is then sent to the stereo headphones, the same on each channel.

Mixed Mode (1001b)

Part is active. All analog outputs are biased. Mixed voiceband and full-range audio (left channel only) is sent to the mono speaker out. Audio from the voiceband codec only is sent to the stereo headphones, the same on each channel.

Mixed Mode (1010b)

Part is active. All analog outputs are biased. Audio from the voiceband codec is sent to the mono speaker out. The left channel only of the full range audio is then sent to both the left and right channels of the stereo headphone out.

REGISTERS

The LM4930 starts on power-up with all registers cleared in Powerdown mode. Powerdown mode is the recommended time to make setup changes to the digital interfaces (PCM bus, I2S bus). Although the configuration registers can be changed in any mode, changes made during Standby or Powerdown prevent unwanted audio artifacts that may occur during rapid mode changes with the outputs active. The LM4930 also features a soft reset. This reset is enabled by setting bit 4 of the BASICCONFIG register.

The VOICETESTCONFIG register is used to set various configuration parameters on the voiceband and full-range audio codecs. SIDETONE_ATTEN (bits 4:1) refers to the level of signal from the MIC input that is fed back into the analog audio output path (commonly used in headphone applications and killed in hands-free applications). Setting the AUTOSIDE bit (bit 5) automatically mutes the sidetone in voice over mono speaker modes so feedback isn't an issue.

Quick mute functions are also located in this register, with bits 13:15 muting the mono speaker amp, the headphone amp, and the mic preamp respectively.

This register also has a CLOCK_DIV bit (bit 6) which, if set, allows for the use of a 24.576MHz clock instead of the default 12.288MHz.

The GAINCONFIG register is used to control the gain of the mono speaker amp, the headphone amp, and the mic preamp. This allows flexible mono speaker gains from -34.5dB to +12dB in 1.5dB steps, headphone amp gains of -46.5dB to 0dB in 1.5dB steps, and mic preamp gains of 17dB to 47dB in 2dB steps. Gain levels may be modified in any mode, but may wait for a zero cross detect in the DAC to eliminate volume control artifacts. This wait for zero cross may be disabled by setting the ZXD_DISABLE bit (bit 7) in the VOICETESTCONFIG register to allow immediate changes.

ANALOG INPUTS AND OUTPUTS

The LM4930 features an analog mono BTL output for connection to an 8Ω external speaker. This output can provide up to 1W of power into an 8Ω load with a 5V analog supply.

Application Information (Continued)

A single-ended stereo headphone output is also featured, providing up to 30mW of power per channel into 32Ω with a 5V analog supply.

A Headphone Sense output is provided on J6 for connection to an external controller. This pin goes high when a head-

phone is present (when used as shown in Figure 5) and will function in all modes independent of other operations the LM4930 may be currently processing.

The MIC Jack input (J3) provides for a low level analog input. Pin 3 provides the power to the MIC and the positive input of the LM4930. Gain for the MIC preamp is set in the GAIN-CONFIG register.

Physical Dimensions inches (millimeters) unless otherwise noted

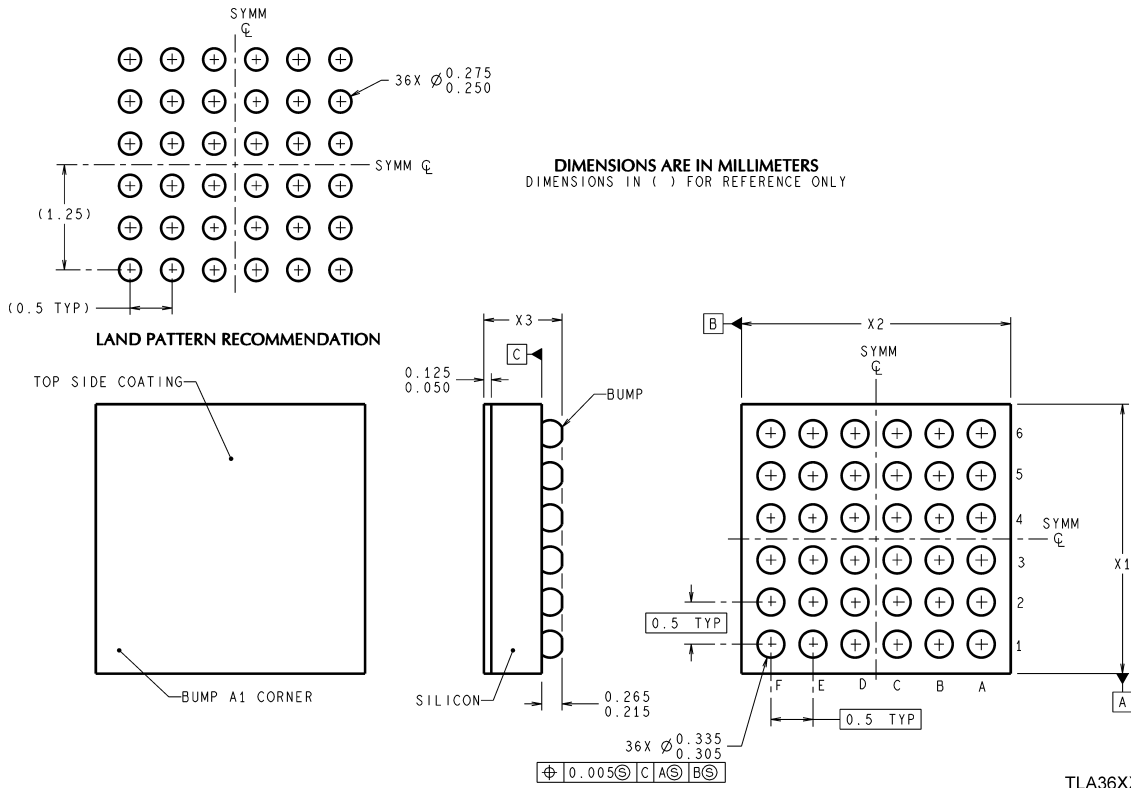

36-Bump micro SMD
Order Number LM4930ITL
NS Package Number TLA36KRA
 $X_1 = 3.230 \pm 0.03\text{mm}$ $X_2 = 3.408 \pm 0.03$ $X_3 = 0.600 \pm 0.075$

Physical Dimensions inches (millimeters) unless otherwise noted (Continued)

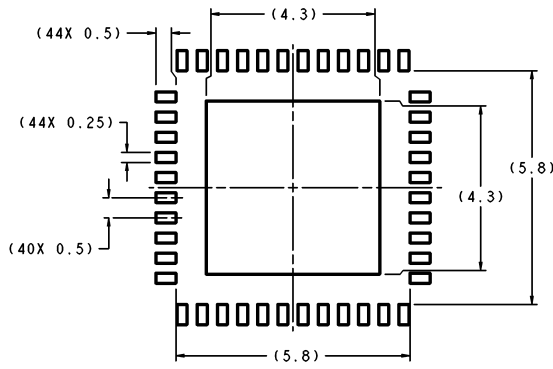

DIMENSIONS ARE IN MILLIMETERS

RECOMMENDED LAND PATTERN
1:1 RATION WITH PKG SOLDER PADS

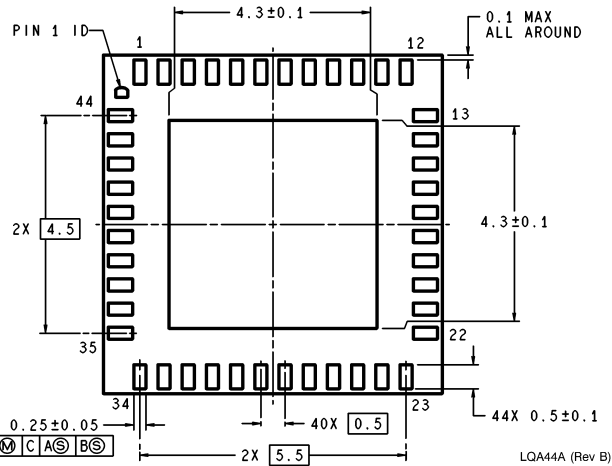
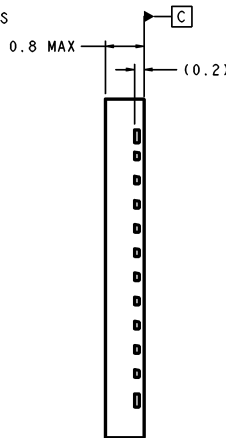
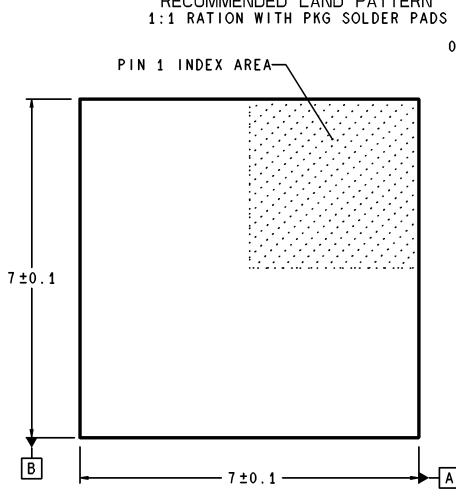

LQA44A (Rev B)

LLP Package
Order Number LM4930LQ
NS Package Number LQA44A

LIFE SUPPORT POLICY

NATIONAL'S PRODUCTS ARE NOT AUTHORIZED FOR USE AS CRITICAL COMPONENTS IN LIFE SUPPORT DEVICES OR SYSTEMS WITHOUT THE EXPRESS WRITTEN APPROVAL OF THE PRESIDENT AND GENERAL COUNSEL OF NATIONAL SEMICONDUCTOR CORPORATION. As used herein:

1. Life support devices or systems are devices or systems which, (a) are intended for surgical implant into the body, or (b) support or sustain life, and whose failure to perform when properly used in accordance with instructions for use provided in the labeling, can be reasonably expected to result in a significant injury to the user.
2. A critical component is any component of a life support device or system whose failure to perform can be reasonably expected to cause the failure of the life support device or system, or to affect its safety or effectiveness.

BANNED SUBSTANCE COMPLIANCE

National Semiconductor certifies that the products and packing materials meet the provisions of the Customer Products Stewardship Specification (CSP-9-111C2) and the Banned Substances and Materials of Interest Specification (CSP-9-111S2) and contain no "Banned Substances" as defined in CSP-9-111S2.



National Semiconductor
Americas Customer Support Center
Email: new.feedback@nsc.com
Tel: 1-800-272-9959

National Semiconductor
Europe Customer Support Center
Fax: +49 (0) 180-530 85 86
Email: europa.support@nsc.com
Deutsch Tel: +49 (0) 69 9508 6208
English Tel: +44 (0) 870 24 0 2171
Français Tel: +33 (0) 1 41 91 8790

National Semiconductor
Asia Pacific Customer Support Center
Email: ap.support@nsc.com

National Semiconductor
Japan Customer Support Center
Fax: 81-3-5639-7507
Email: jpn.feedback@nsc.com
Tel: 81-3-5639-7560

www.national.com

National does not assume any responsibility for use of any circuitry described, no circuit patent licenses are implied and National reserves the right at any time without notice to change said circuitry and specifications.