

LM4755

Stereo 11W Audio Power Amplifier with Mute

General Description

The LM4755 is a stereo audio amplifier capable of delivering 11W per channel of continuous average output power to a 4Ω load or 7W per channel into 8Ω using a single 24V supply at 10% THD+N. The internal mute circuit and pre-set gain resistors provide for a very economical design solution.

Output power specifications at both 20V and 24V supplies and low external component count offer high value to consumer electronic manufacturers for stereo TV and compact stereo applications. The LM4755 is specifically designed for single supply operation.

Key Specifications

- Output power at 10% THD with 1kHz into 4Ω at $V_{CC} = 24V$: 11W (typ)
- Output power at 10% THD with 1kHz into 8Ω at $V_{CC} = 24V$: 7W (typ)
- Closed loop gain: 34dB (typ)
- P_O at 10% THD+N @ 1kHz into 4Ω single-ended TO-263 package at $V_{CC}=12V$: 2.5W (typ)

- P_O at 10% THD+N @ 1kHz into 8Ω bridged TO-263 package at $V_{CC}=12V$: 5W (typ)

Features

- Drives 4Ω and 8Ω loads
- Integrated mute function
- Internal Gain Resistors
- Minimal external components needed
- Single supply operation
- Internal current limiting and thermal protection
- Compact 9-lead TO-220 package
- Wide supply range 9V - 40V

Applications

- Stereos TVs
- Compact stereos
- Mini component stereos

Typical Application

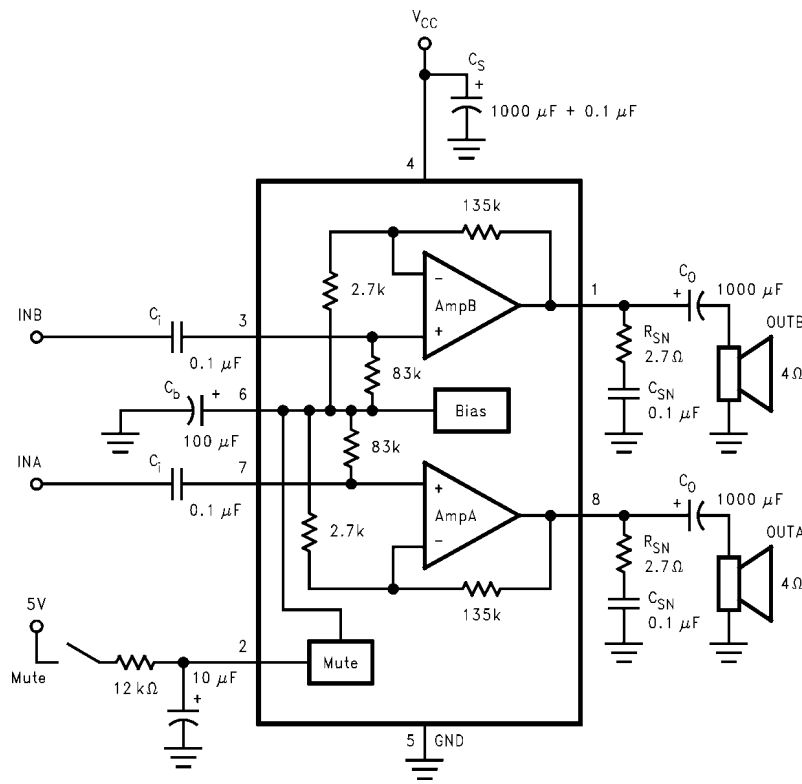
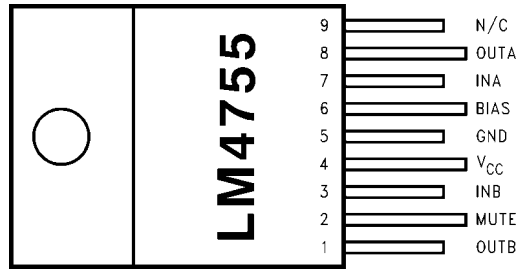

FIGURE 1. Typical Audio Amplifier Application Circuit

Connection Diagrams

Plastic Package



10005902

Package Description
Top View
Order Number LM4755T
Package Number TA09A

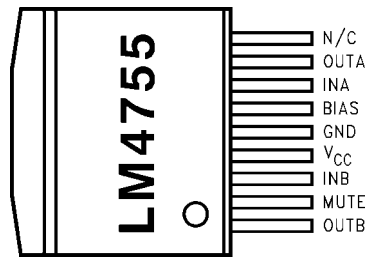

10005936

Top View
Order Number LM4755TS
Package Number TS9A

Absolute Maximum Ratings (Note 2)

If Military/Aerospace specified devices are required, please contact the National Semiconductor Sales Office/Distributors for availability and specifications.

Supply Voltage	40V
Input Voltage	±0.7V
Input Voltage at Output Pins (Note 8)	GND -0.4V
Output Current	Internally Limited
Power Dissipation (Note 3)	62.5W
ESD Susceptibility (Note 4)	2 kV
Junction Temperature	150°C

Soldering Information

T Package (10 seconds)

250°C

Storage Temperature

-40°C to 150°C

Operating Ratings

Temperature Range

$$T_{\text{MIN}} \leq T_A \leq T_{\text{MAX}}$$

$$-40^\circ\text{C} \leq T_A \leq +85^\circ\text{C}$$

Supply Voltage

9V to 32V

 θ_{JC}

2°C/W

 θ_{JA}

76°C/W

Electrical Characteristics

The following specifications apply to each channel with $V_{\text{CC}} = 24\text{V}$, $T_A = 25^\circ\text{C}$ unless otherwise specified.

Symbol	Parameter	Conditions	LM4755		Units (Limits)
			Typical (Note 5)	Limit	
I_{TOTAL}	Total Quiescent Power Supply Current	Mute Off	10	15	mA(max)
		Mute On	7	7	mA(min)
P_{O}	Output Power (Continuous Average per Channel)	$f = 1\text{ kHz}$, THD+N = 10%, $R_L = 8\Omega$	7		W
		$f = 1\text{ kHz}$, THD+N = 10%, $R_L = 4\Omega$	11	10	W(min)
		$V_S = 20\text{V}$, $R_L = 8\Omega$	4		W
		$V_S = 20\text{V}$, $R_L = 4\Omega$	7		W
		$f = 1\text{ kHz}$, THD+N = 10%, $R_L = 4\Omega$ $V_S = 12\text{V}$, TO-263 Pkg.	2.5		W
THD	Total Harmonic Distortion	$f = 1\text{ kHz}$, $P_{\text{O}} = 1\text{ W/ch}$, $R_L = 8\Omega$	0.08		%
V_{OSW}	Output Swing	$P_{\text{O}} = 10\text{W}$, $R_L = 8\Omega$	15		V
		$P_{\text{O}} = 10\text{W}$, $R_L = 4\Omega$	14		V
X_{TALK}	Channel Separation	See Apps. Circuit $f = 1\text{ kHz}$, $V_{\text{O}} = 4\text{ Vrms}$	55		dB
PSRR	Power Supply Rejection Ratio	See Apps. Circuit $f = 120\text{ Hz}$, $V_{\text{O}} = 1\text{ mVrms}$	50		dB
V_{ODV}	Differential DC Output Offset Voltage	$V_{\text{IN}} = 0\text{V}$	0.09	0.4	V(max)
SR	Slew Rate		2		V/ μs
R_{IN}	Input Impedance		83		k Ω
PBW	Power Bandwidth	3 dB BW at $P_{\text{O}} = 2.5\text{W}$, $R_L = 8\Omega$	65		kHz
A_{VCL}	Closed Loop Gain (Internally Set)	$R_L = 8\Omega$	34	33	dB(min)
				35	dB(max)
ϵ_{IN}	Noise	IHF-A Weighting Filter, $R_L = 8\Omega$ Output Referred	0.2		mVrms
I_{O}	Output Short Circuit Limit	$V_{\text{IN}} = 0.5\text{V}$, $R_L = 2\Omega$		2	A(min)
Mute Pin V_{IL}	Mute Low Input Voltage	Not in Mute Mode		0.8	V(max)
V_{IH}	Mute High Input Voltage	In Mute Mode	2.0	2.5	V(min)
A_{M}	Mute Attenuation	$V_{\text{MUTE}} = 5.0\text{V}$	80		dB

Note 1: All voltages are measured with respect to the GND pin (5), unless otherwise specified.

Note 2: Absolute Maximum Ratings indicate limits beyond which damage to the device may occur. Operating Ratings indicate conditions for which the device is functional, but do not guarantee specific performance limits. Electrical Characteristics state DC and AC electrical specifications under particular test conditions which guarantee specific performance limits. This assumes that the device is within the Operating Ratings. Specifications are not guaranteed for parameters where no limit is given, however, the typical value is a good indication of device performance.

Note 3: For operating at case temperatures above 25°C, the device must be derated based on a 150°C maximum junction temperature and a thermal resistance of $\theta_{JC} = 2^{\circ}\text{C}/\text{W}$ (junction to case). Refer to the section Determining the Maximum Power Dissipation in the **Application Information** section for more information.

Note 4: Human body model, 100 pF discharged through a 1.5 k Ω resistor.

Note 5: Typicals are measured at 25°C and represent the parametric norm.

Note 6: Limits are guaranteed that all parts are tested in production to meet the stated values.

Note 7: The TO-263 Package is not recommended for $V_S > 16\text{V}$ due to impractical heatsinking limitations.

Note 8: The outputs of the LM4755 cannot be driven externally in any mode with a voltage lower than -0.4V below GND or permanent damage to the LM4755 will result.

Equivalent Schematic

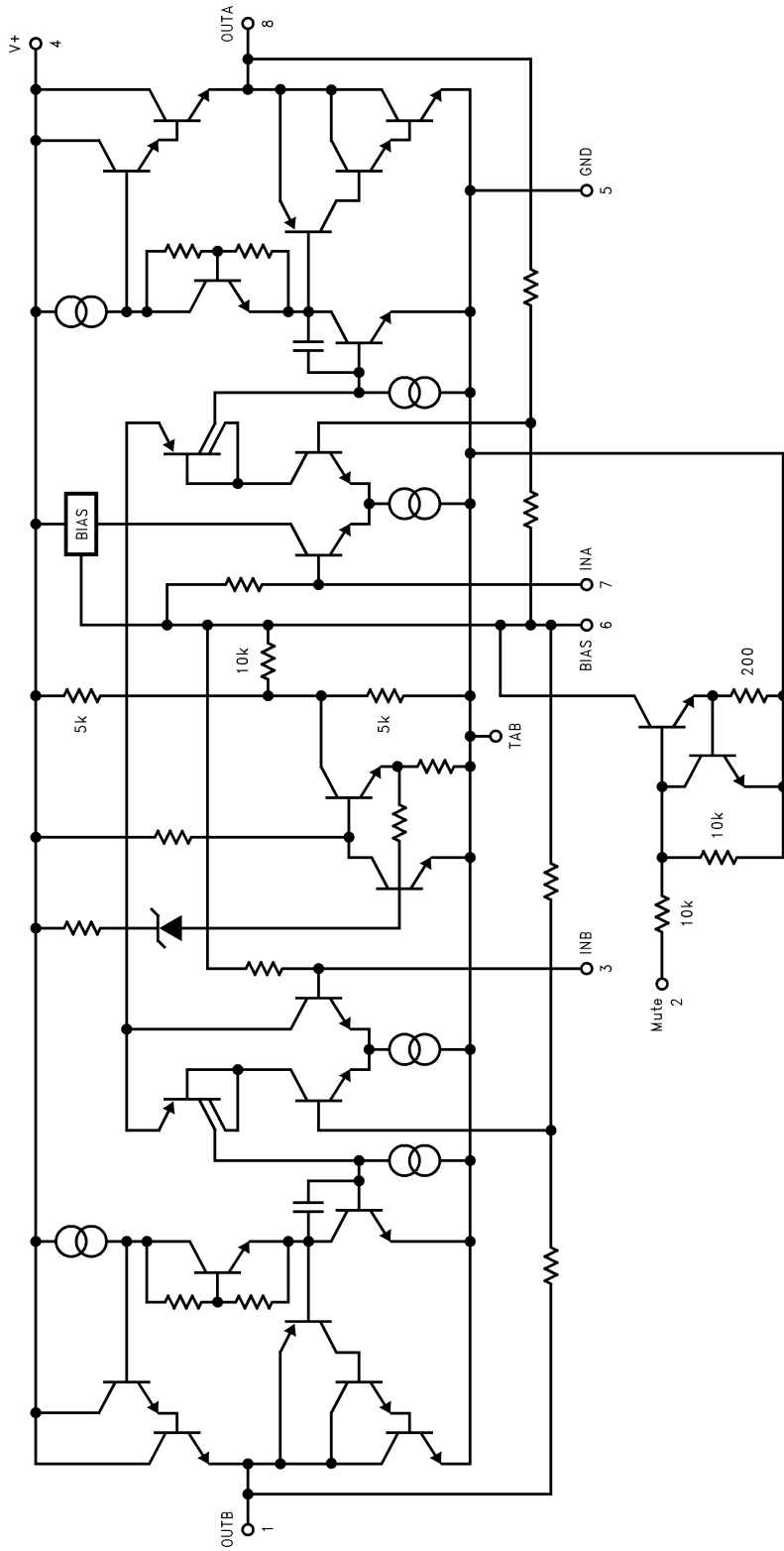

10005903

Test Circuit

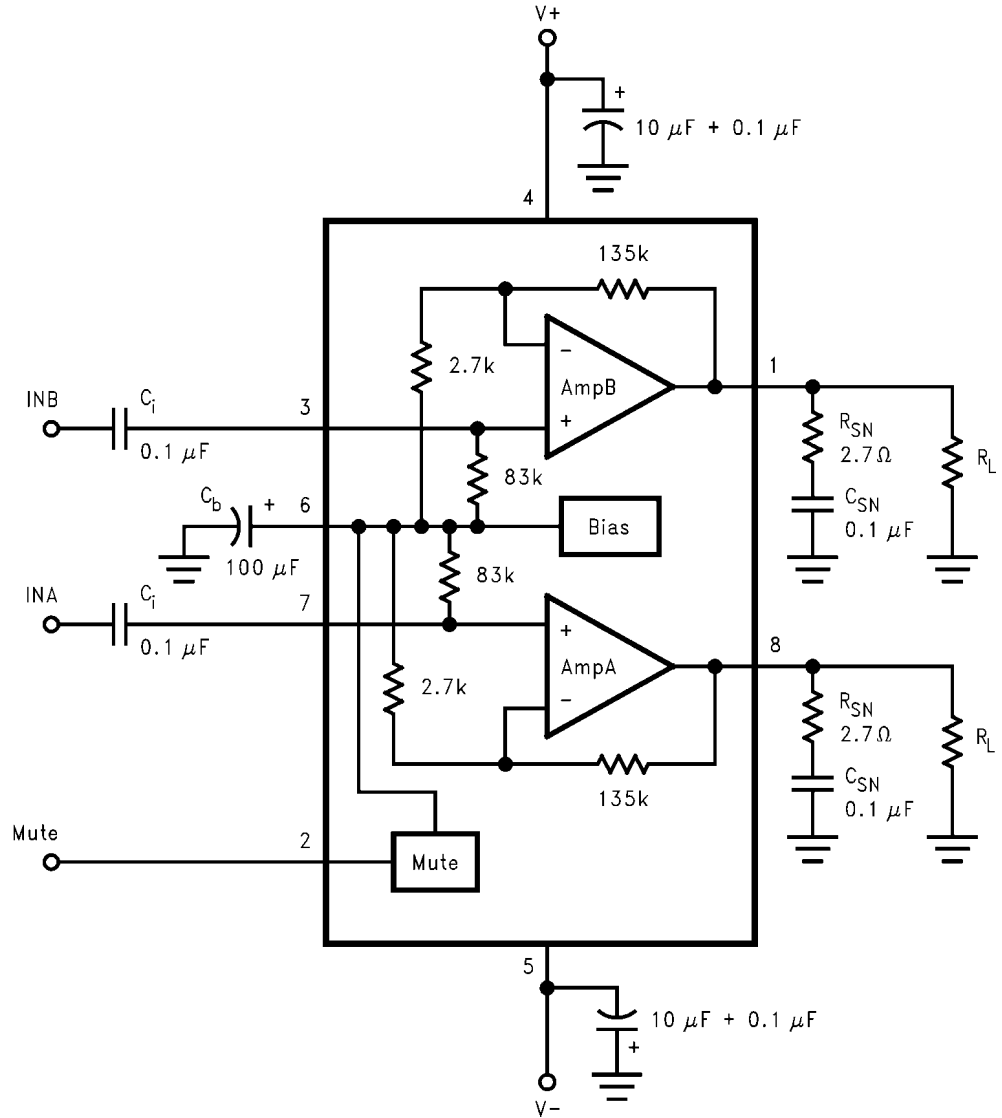

10005904

FIGURE 2. Test Circuit

System Application Circuit

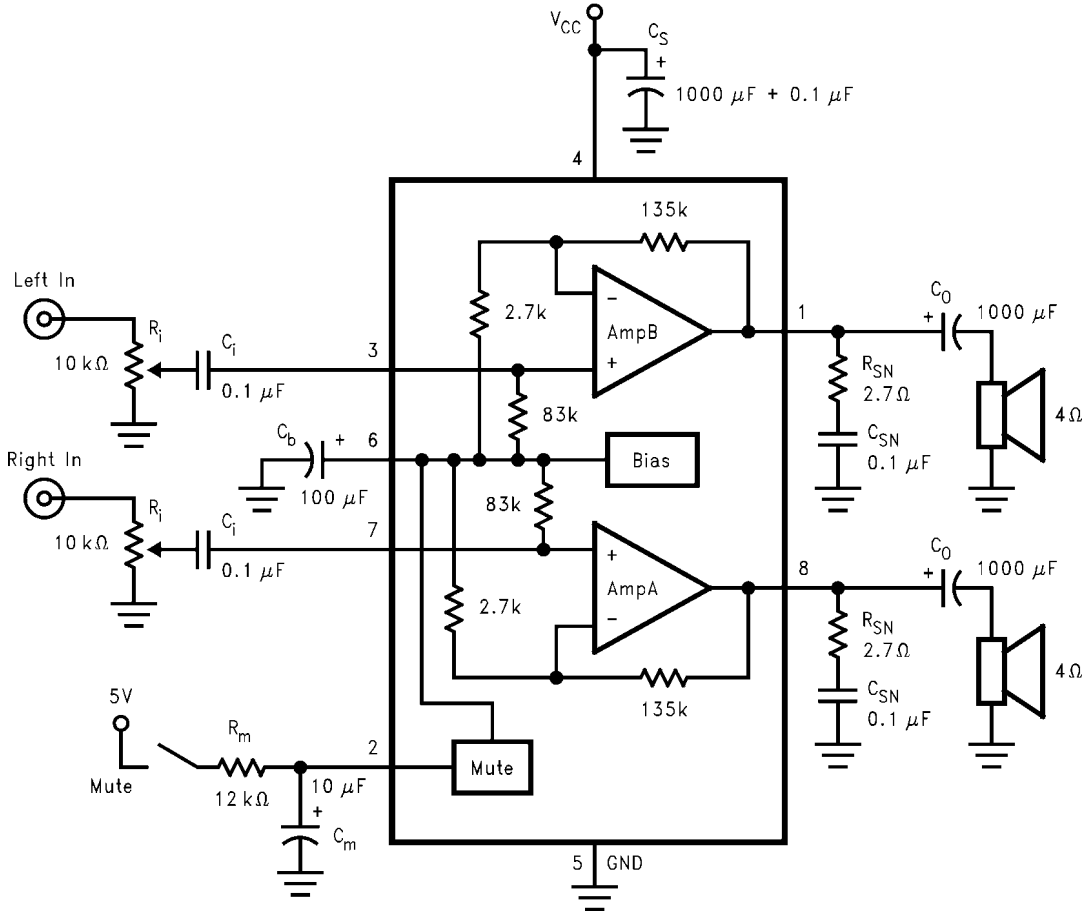

10005905

FIGURE 3. Circuit for External Components Description

External Components Description

Components	Function Description
1, 2 C_S	Provides power supply filtering and bypassing.
3, 4 R_{SN}	Works with C_{SN} to stabilize the output stage from high frequency oscillations.
5, 6 C_{SN}	Works with R_{SN} to stabilize the output stage from high frequency oscillations.
7 C_b	Provides filtering for the internally generated half-supply bias generator.
8, 9 C_i	Input AC coupling capacitor which blocks DC voltage at the amplifier's input terminals. Also creates a high pass filter with $f_c=1/(2 \cdot \pi \cdot R_{in} \cdot C_{in})$.
10, 11 C_o	Output AC coupling capacitor which blocks DC voltage at the amplifier's output terminal. Creates a high pass filter with $f_c=1/(2 \cdot \pi \cdot R_{out} \cdot C_{out})$.
12, 13 R_i	Voltage control - limits the voltage level allowed to the amplifier's input terminals.
14 R_m	Works with C_m to provide mute function timing.
15 C_m	Works with R_m to provide mute function timing.

Typical Performance Characteristics (Note 5)

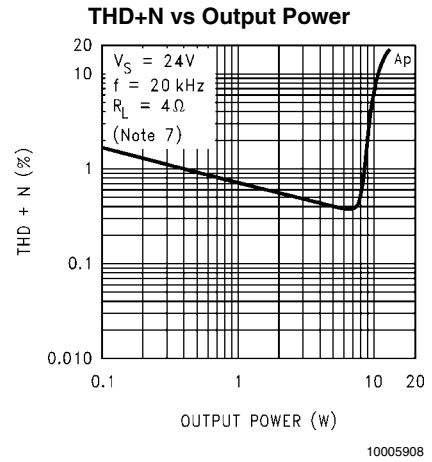
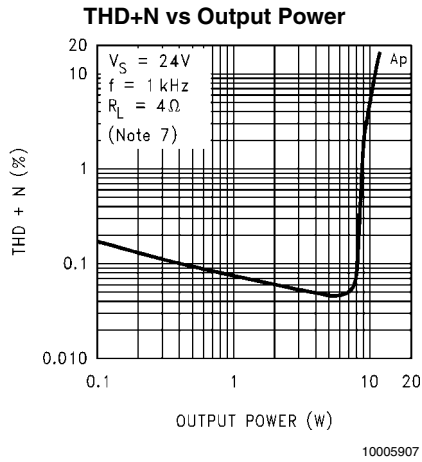
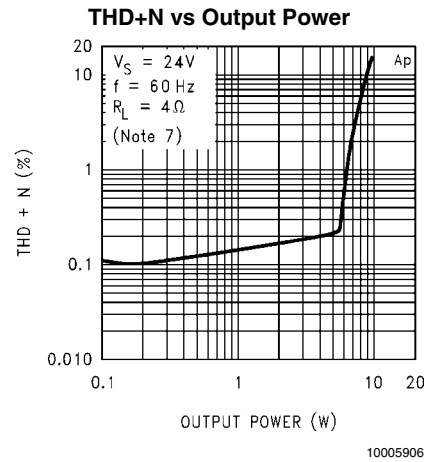
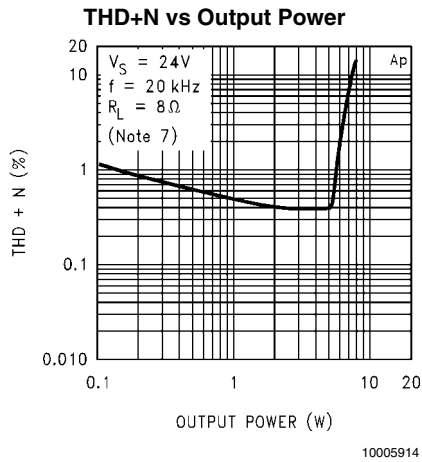
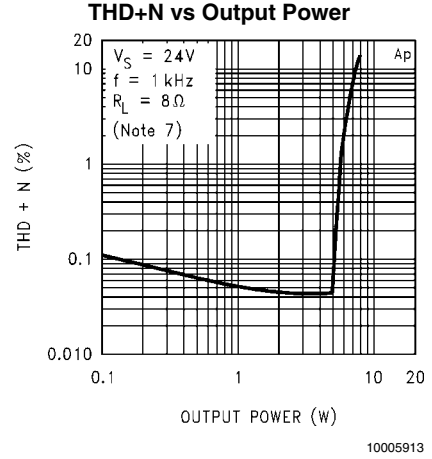
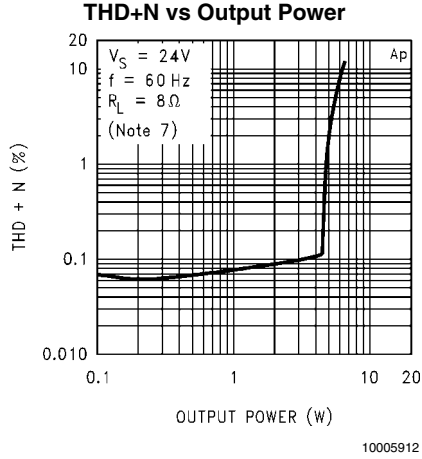

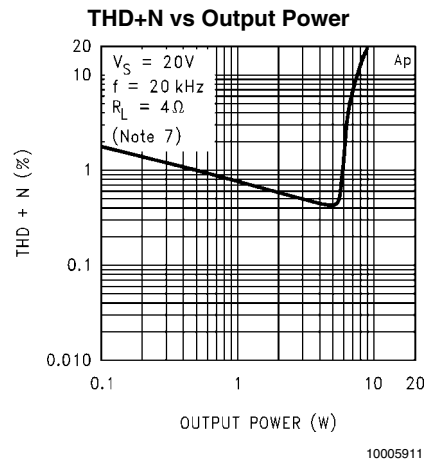
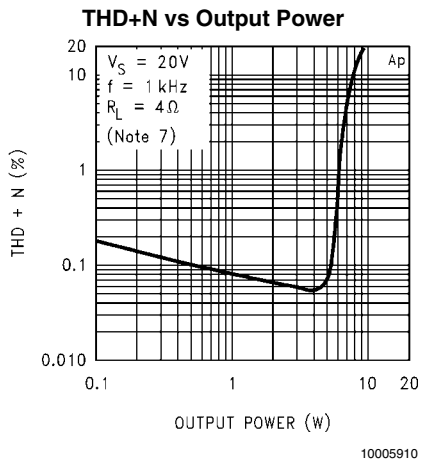
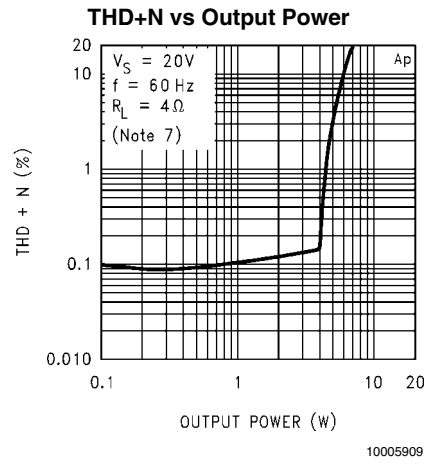
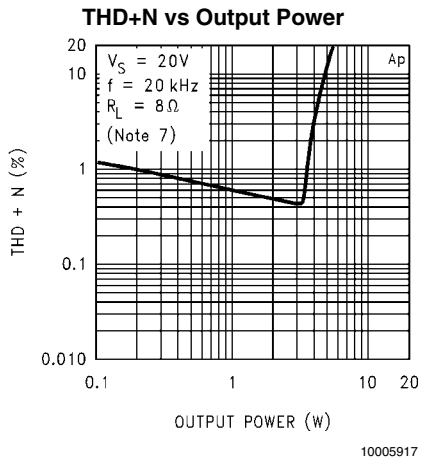
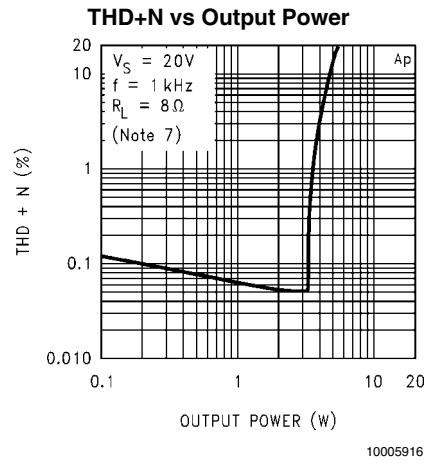
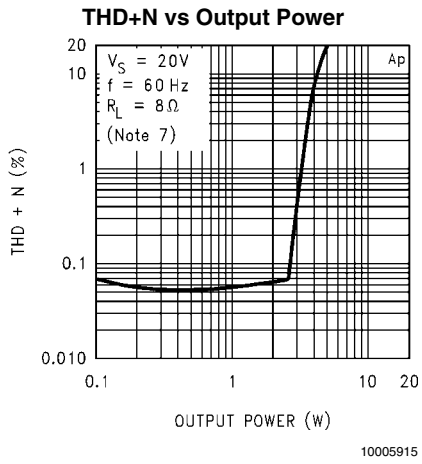

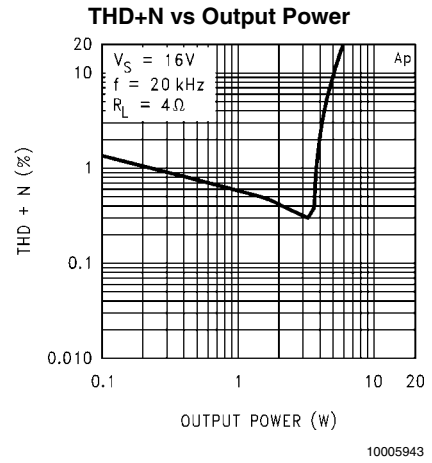
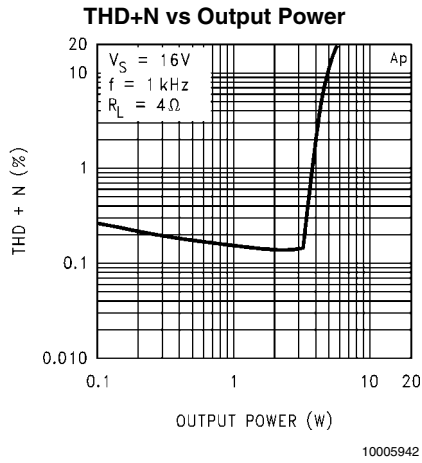
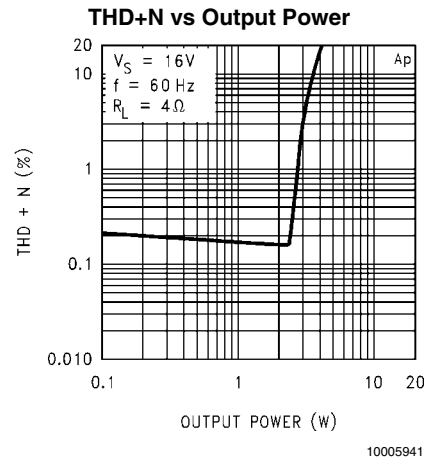
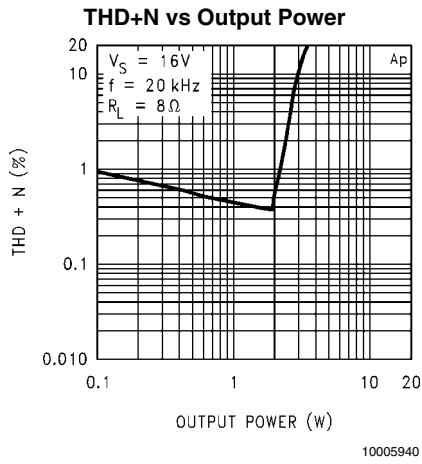
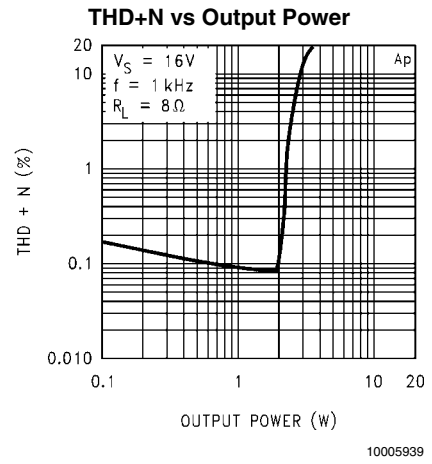
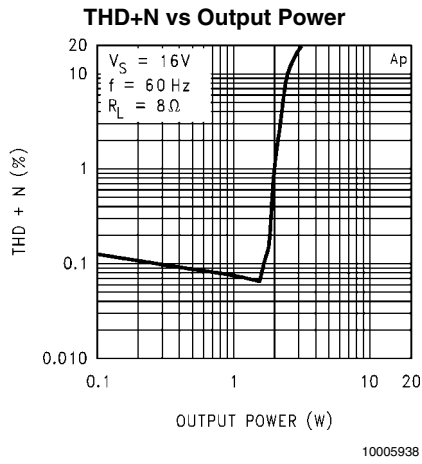

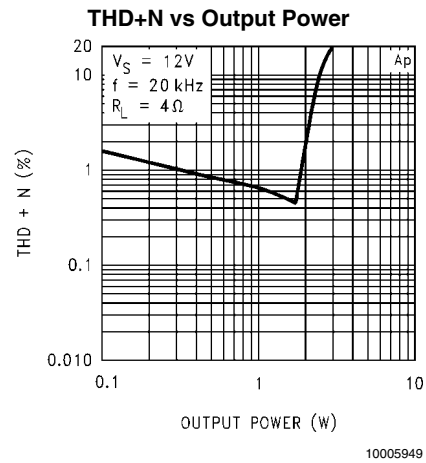
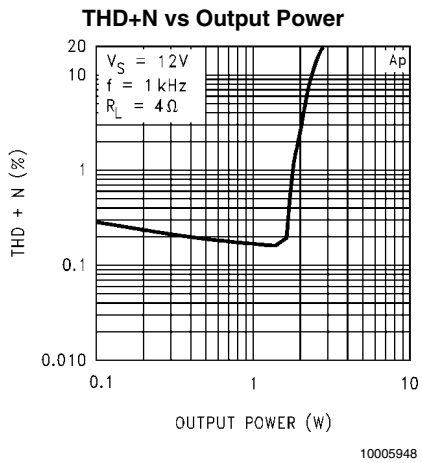
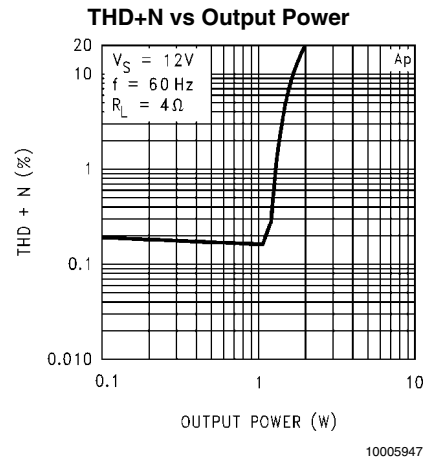
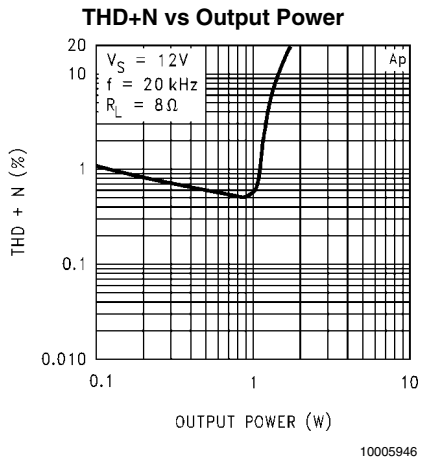
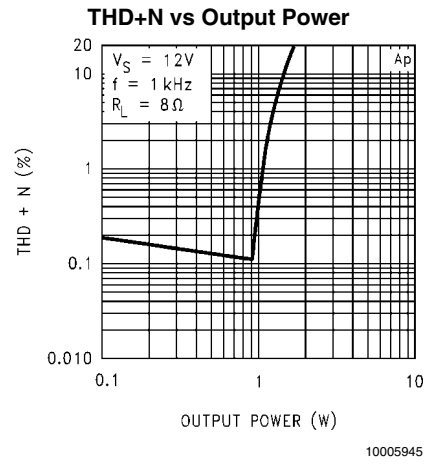
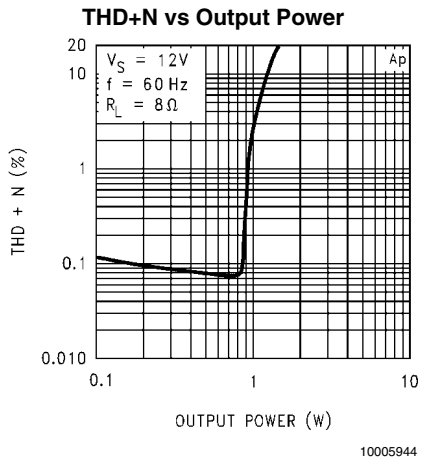

Output Power vs Supply Voltage

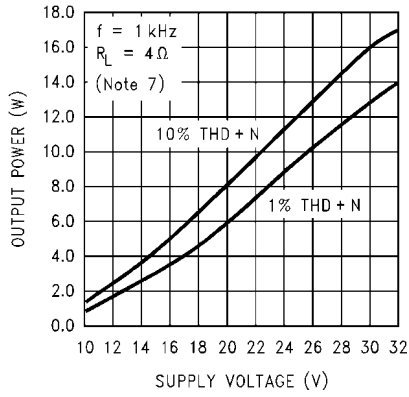

10005918

Output Power vs Supply Voltage

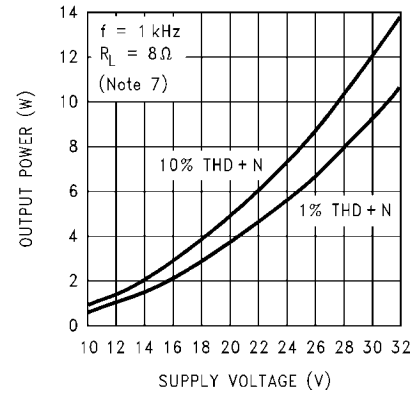

10005919

Frequency Response

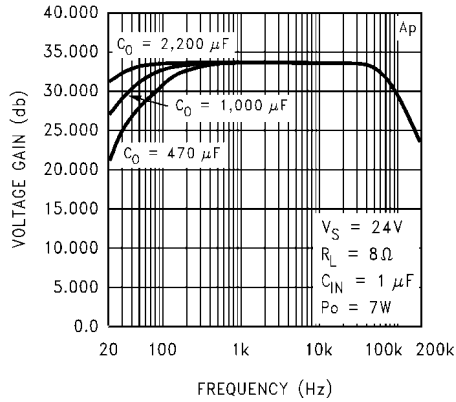

10005920

THD+N vs Frequency

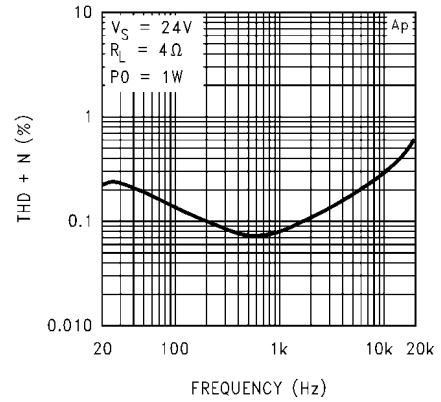

10005921

THD+N vs Frequency

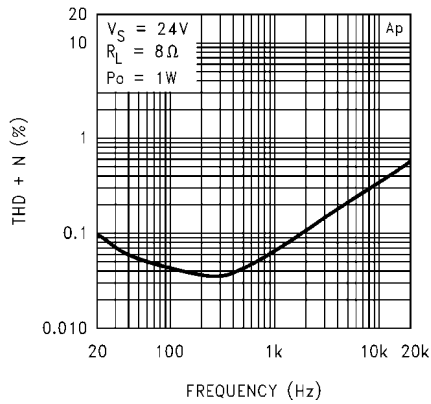

10005922

Frequency Response

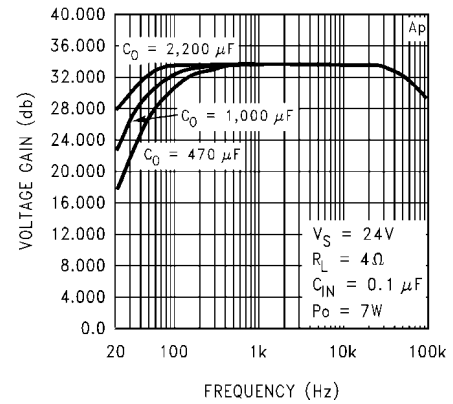

10005923

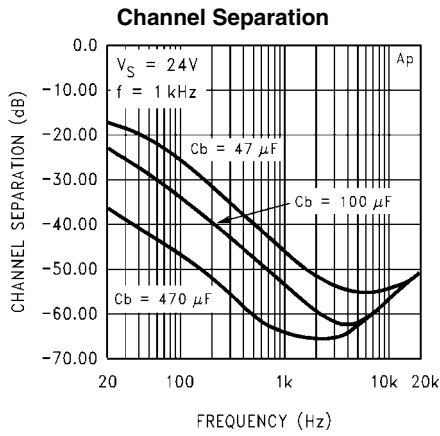

10005924

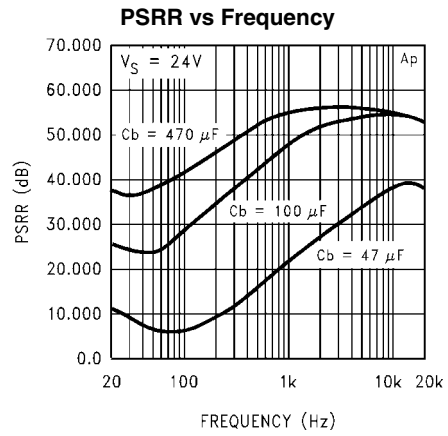

10005925

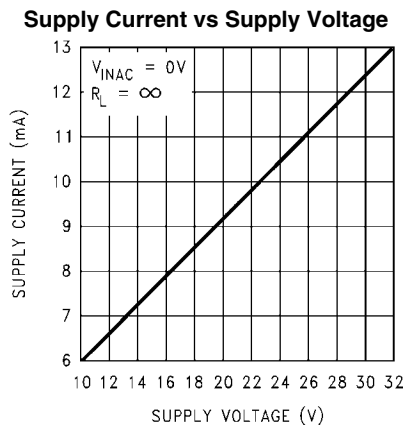

10005926

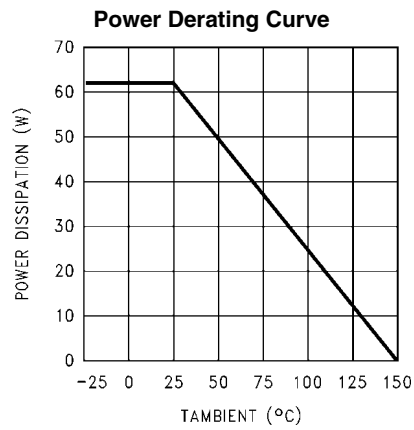

10005927

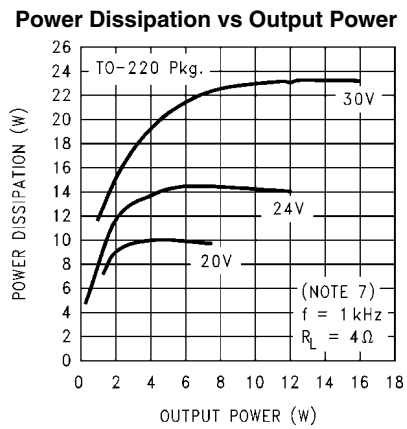

10005928

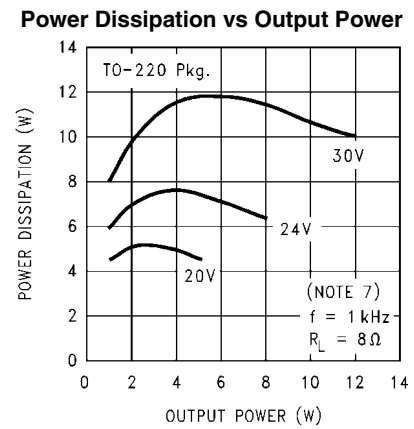

10005929

Power Dissipation vs Output Power

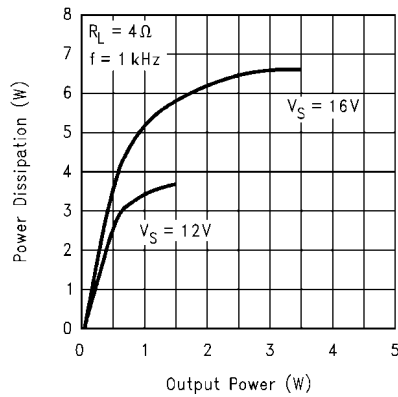

10005960

Power Dissipation vs Output Power

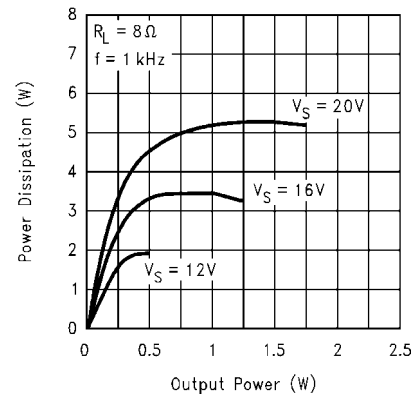

10005961

Application Information

The LM4755 contains circuitry to pull down the bias line internally, effectively shutting down the input stage. An external R-C should be used to adjust the timing of the pull-down. If the bias line is pulled down too quickly, currents induced in the internal bias resistors will cause a momentary DC voltage to appear across the inputs of each amplifier's internal differential pair, resulting in an output DC shift towards V_{supply} . An R-C timing circuit should be used to limit the pull-down time such that output "pops" and signal feedthroughs will be minimized. The pull-down timing is a function of a number of factors, including the internal mute circuitry, the voltage used to activate the mute, the bias capacitor, the half-supply voltage, and internal resistances used in the half-supply generator. *Table 1* shows a list of recommended values for the external R-C.

TABLE 1. Recommended Values for Mute Circuit

V_{MUTE}	V_{CC}	R_m	C_m
5V	12V	18 k Ω	10 μ F
5V	15V	18 k Ω	10 μ F
5V	20V	12 k Ω	10 μ F
5V	24V	12 k Ω	10 μ F
5V	28V	8.2 k Ω	10 μ F
5V	30V	8.2 k Ω	10 μ F

CAPACITOR SELECTION AND FREQUENCY RESPONSE

With the LM4755, as in all single supply amplifiers, AC coupling capacitors are used to isolate the DC voltage present at

the inputs (pins 3, 7) and outputs (pins 1, 8). As mentioned earlier in the **External Components** section these capacitors create high-pass filters with their corresponding input/output impedances. The **Typical Application Circuit** shown in *Figure 1* shows input and output capacitors of 0.1 μ F and 1,000 μ F respectively. At the input, with an 83 k Ω typical input resistance, the result is a high pass 3 dB point occurring at 19 Hz. There is another high pass filter at 39.8 Hz created with the output load resistance of 4 Ω . Careful selection of these components is necessary to ensure that the desired frequency response is obtained. The Frequency Response curves in the **Typical Performance Characteristics** section show how different output coupling capacitors affect the low frequency roll-off.

OPERATING IN BRIDGE-MODE

Though designed for use as a single-ended amplifier, the LM4755 can be used to drive a load differentially (bridge-mode). Due to the low pin count of the package, only the non-inverting inputs are available. An inverted signal must be provided to one of the inputs. This can easily be done with the use of an inexpensive op-amp configured as a standard inverting amplifier. An LF353 is a good low-cost choice. Care must be taken, however, for a bridge-mode amplifier must theoretically dissipate four times the power of a single-ended type. The load seen by each amplifier is effectively half that of the actual load being used, thus an amplifier designed to drive a 4 Ω load in single-ended mode should drive an 8 Ω load when operating in bridge-mode.

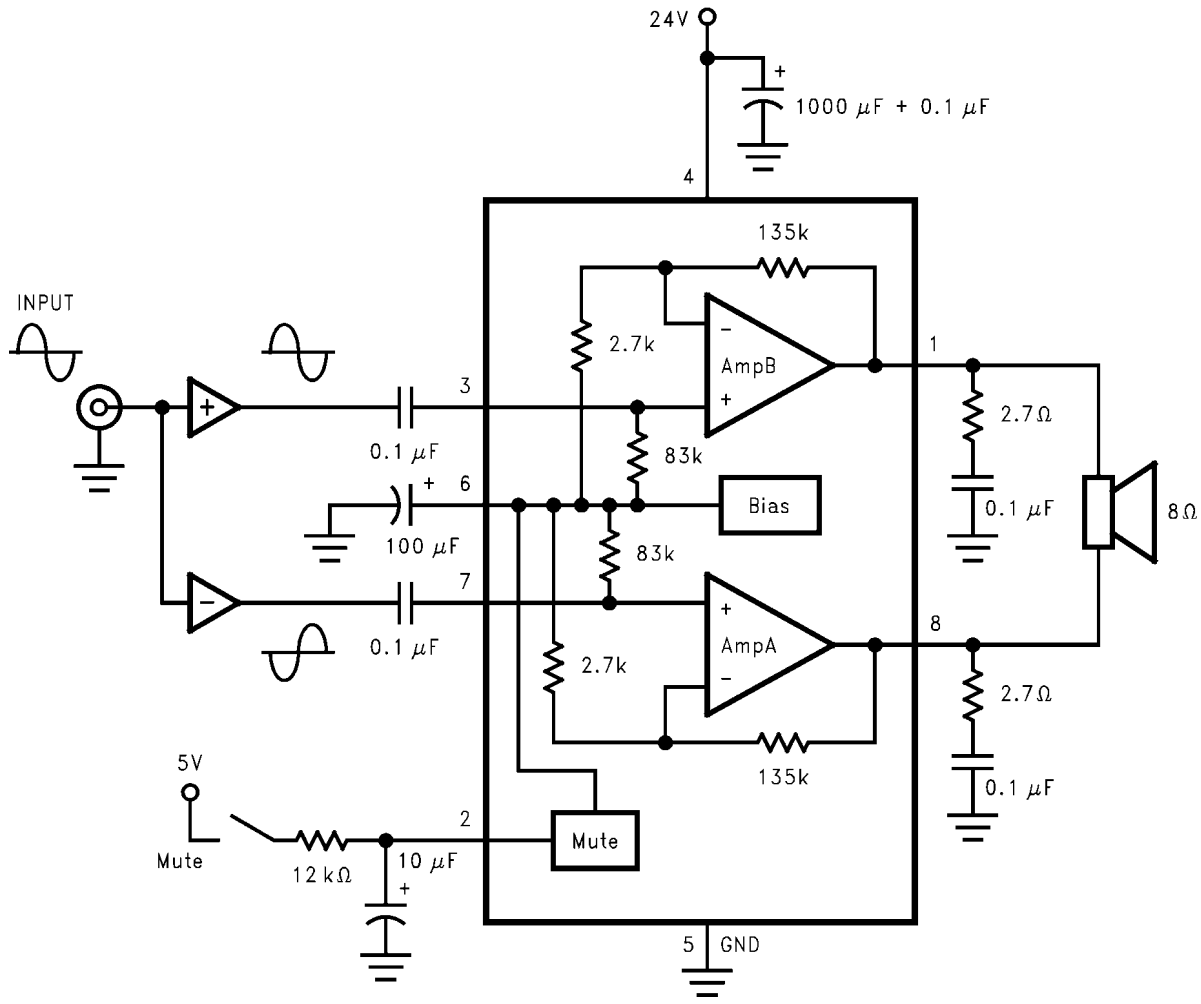

10005930

FIGURE 4. Bridge-Mode Application

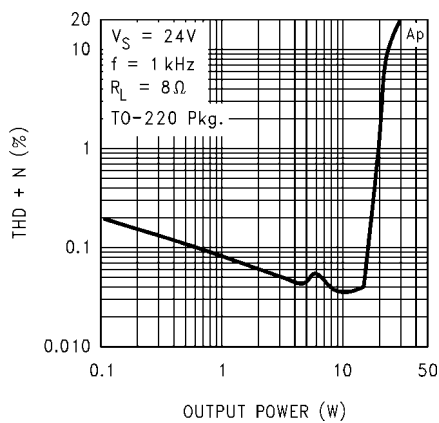

10005931

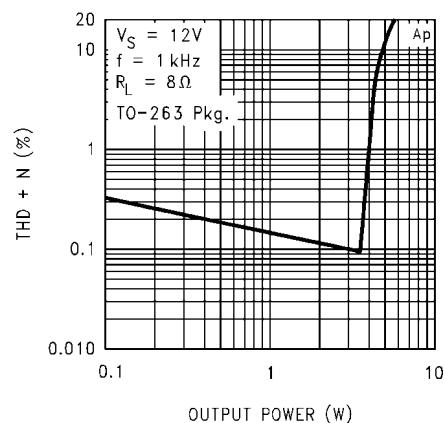

10005937

FIGURE 5. THD+N vs P_{OUT} for Bridge-Mode Application

PREVENTING OSCILLATIONS

With the integration of the feedback and bias resistors on-chip, the LM4755 fits into a very compact package. However, due to the close proximity of the non-inverting input pins to the corresponding output pins, the inputs should be AC terminated at all times. If the inputs are left floating, the amplifier will have a positive feedback path through high impedance coupling, resulting in a high frequency oscillation. In most applications, this termination is typically provided by the previous stage's source impedance. If the application will require an external signal, the inputs should be terminated to ground with a resistance of 50 k Ω or less on the AC side of the input coupling capacitors.

UNDERVOLTAGE SHUTDOWN

If the power supply voltage drops below the minimum operating supply voltage, the internal under-voltage detection circuitry pulls down the half-supply bias line, shutting down the preamp section of the LM4755. Due to the wide operating supply range of the LM4755, the threshold is set to just under 9V. There may be certain applications where a higher threshold voltage is desired. One example is a design requiring a high operating supply voltage, with large supply and bias capacitors, and there is little or no other circuitry connected to the main power supply rail. In this circuit, when the power is disconnected, the supply and bias capacitors will discharge at a slower rate, possibly resulting in audible output distortion as the decaying voltage begins to clip the output signal. An external circuit may be used to sense for the desired threshold, and pull the bias line (pin 6) to ground to disable the input preamp. *Figure 6* shows an example of such a circuit. When the voltage across the zener diode drops below its threshold, current flow into the base of Q1 is interrupted. Q2 then turns on, discharging the bias capacitor. This discharge rate is governed by several factors, including the bias capacitor value, the bias voltage, and the resistor at the emitter of Q2. An equation for approximating the value of the emitter discharge resistor, R, is given below:

$$R = (0.7v) / (Cb \cdot (V_{CC}/2) / 0.1s)$$

Note that this is only a linearized approximation based on a discharge time of 0.1s. The circuit should be evaluated and adjusted for each application.

As mentioned earlier in the **Built-in Mute Circuit** section, when using an external circuit to pull down the bias line, the rate of discharge will have an effect on the turn-off induced distortions. Please refer to the **Built-in Mute Circuit** section for more information.

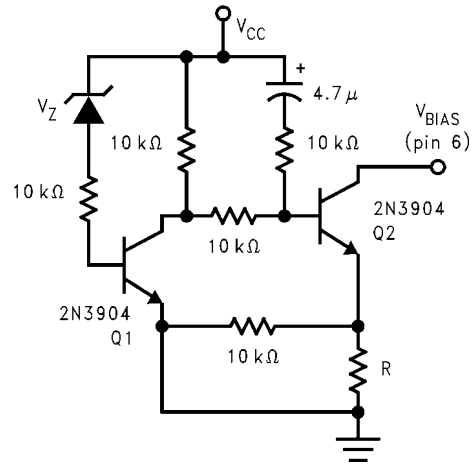

10005932

FIGURE 6. External Undervoltage Pull-Down

THERMAL CONSIDERATIONS

Heat Sinking

Proper heatsinking is necessary to ensure that the amplifier will function correctly under all operating conditions. A heatsink that is too small will cause the die to heat excessively and will result in a degraded output signal as the thermal protection circuitry begins to operate.

The choice of a heatsink for a given application is dictated by several factors: the maximum power the IC needs to dissipate, the worst-case ambient temperature of the circuit, the junction-to-case thermal resistance, and the maximum junction temperature of the IC. The heat flow approximation equation used in determining the correct heatsink maximum thermal resistance is given below:

$$T_J - T_A = P_{D\text{MAX}} \cdot (\theta_{JC} + \theta_{CS} + \theta_{SA})$$

where:

$P_{D\text{MAX}}$ = maximum power dissipation of the IC

T_J ($^{\circ}\text{C}$) = junction temperature of the IC

T_A ($^{\circ}\text{C}$) = ambient temperature

θ_{JC} ($^{\circ}\text{C}/\text{W}$) = junction-to-case thermal resistance of the IC

θ_{CS} ($^{\circ}\text{C}/\text{W}$) = case-to-heatsink thermal resistance (typically 0.2 to 0.5 $^{\circ}\text{C}/\text{W}$)

θ_{SA} ($^{\circ}\text{C}/\text{W}$) = thermal resistance of heatsink

When determining the proper heatsink, the above equation should be re-written as:

$$\theta_{SA} \leq [(T_J - T_A) / P_{D\text{MAX}}] - \theta_{JC} - \theta_{CS}$$

TO-263 HEATSINKING

Surface mount applications will be limited by the thermal dissipation properties of printed circuit board area. The TO-263 package is not recommended for surface mount applications with $V_S > 16\text{V}$ due to limited printed circuit board area. There are TO-263 package enhancements, such as clip-on heatsinks and heatsinks with adhesives, that can be used to improve performance.

Standard FR-4 single-sided copper clad will have an approximate Thermal resistance (θ_{SA}) ranging from:

1.5 x 1.5 in. sq.	20–27 $^{\circ}\text{C}/\text{W}$	($T_A = 28^{\circ}\text{C}$, Sine wave testing, 1 oz. Copper)
2 x 2 in. sq.	16–23 $^{\circ}\text{C}/\text{W}$	

The above values for θ_{SA} vary widely due to dimensional proportions (i.e. variations in width and length will vary θ_{SA}).

For audio applications, where peak power levels are short in duration, this part will perform satisfactory with less heatsinking/copper clad area. As with any high power design proper bench testing should be undertaken to assure the design can dissipate the required power. Proper bench testing requires attention to worst case ambient temperature and air flow. At high power dissipation levels the part will show a tendency to increase saturation voltages, thus limiting the undistorted power levels.

DETERMINING MAXIMUM POWER DISSIPATION

For a single-ended class AB power amplifier, the theoretical maximum power dissipation point is a function of the supply voltage, V_S , and the load resistance, R_L and is given by the following equation:

(single channel)

$$P_{DMAX} (W) = [V_S^2 / (2 \cdot \pi^2 \cdot R_L)]$$

The above equation is for a single channel class-AB power amplifier. For dual amplifiers such as the LM4755, the equation for calculating the total maximum power dissipated is:

(dual channel)

$$P_{DMAX} (W) = 2 \cdot [V_S^2 / (2 \cdot \pi^2 \cdot R_L)]$$

or

$$V_S^2 / (\pi^2 \cdot R_L)$$

(Bridged Outputs)

$$P_{DMAX} (W) = 4[V_S^2 / (2\pi^2 \cdot R_L)]$$

HEATSINK DESIGN EXAMPLE

Determine the system parameters:

$V_S = 24V$	Operating Supply Voltage
$R_L = 4\Omega$	Minimum Load Impedance
$T_A = 55^\circ C$	Worst Case Ambient Temperature

Device parameters from the datasheet:

$T_J = 150^\circ C$	Maximum Junction Temperature
$\theta_{JC} = 2^\circ C/W$	Junction-to-Case Thermal Resistance

Calculations:

$$2 \cdot P_{DMAX} = 2 \cdot [V_S^2 / (2 \cdot \pi^2 \cdot R_L)] = (24V)^2 / (2 \cdot \pi^2 \cdot 4\Omega) = 14.6W$$

$$\theta_{SA} \leq [(T_J - T_A) / P_{DMAX}] - \theta_{JC} - \theta_{CS} = [(150^\circ C - 55^\circ C) / 14.6W] - 2^\circ C/W - 0.2^\circ C/W = 4.3^\circ C/W$$

Conclusion: Choose a heatsink with $\theta_{SA} \leq 4.3^\circ C/W$.

TO-263 HEATSINK DESIGN EXAMPLES

Example 1: (Stereo Single-Ended Output)

Given:	$T_A = 30^\circ C$
	$T_J = 150^\circ C$
	$R_L = 4\Omega$
	$V_S = 12V$
	$\theta_{JC} = 2^\circ C/W$

P_{DMAX} from P_D vs P_O Graph:

$$P_{DMAX} \approx 3.7W$$

Calculating P_{DMAX} :

$$P_{DMAX} = V_{CC}^2 / (\pi^2 R_L) = (12V)^2 / (\pi^2 (4\Omega)) = 3.65W$$

Calculating Heatsink Thermal Resistance:

$$\theta_{SA} < T_J - T_A / P_{DMAX} - \theta_{JC} - \theta_{CS}$$

$$\theta_{SA} < 120^\circ C / 3.7W - 2.0^\circ C/W - 0.2^\circ C/W = 30.2^\circ C/W$$

Therefore the recommendation is to use 1.5×1.5 square inch of single-sided copper clad.

Example 2: (Stereo Single-Ended Output)

Given:	$T_A = 50^\circ C$
	$T_J = 150^\circ C$
	$R_L = 4\Omega$
	$V_S = 12V$
	$\theta_{JC} = 2^\circ C/W$

P_{DMAX} from P_D vs P_O Graph:

$$P_{DMAX} \approx 3.7W$$

Calculating P_{DMAX} :

$$P_{DMAX} = V_{CC}^2 / (\pi^2 R_L) = (12V)^2 / (\pi^2 (4\Omega)) = 3.65W$$

Calculating Heatsink Thermal Resistance:

$$\theta_{SA} < [(T_J - T_A) / P_{DMAX}] - \theta_{JC} - \theta_{CS}$$

$$\theta_{SA} < 100^\circ C / 3.7W - 2.0^\circ C/W - 0.2^\circ C/W = 24.8^\circ C/W$$

Therefore the recommendation is to use 2.0×2.0 square inch of single-sided copper clad.

Example 3: (Bridged Output)

Given:	$T_A = 50^\circ C$
	$T_J = 150^\circ C$
	$R_L = 8\Omega$
	$V_S = 12V$
	$\theta_{JC} = 2^\circ C/W$

Calculating P_{DMAX} :

$$P_{DMAX} = 4[V_{CC}^2 / (2\pi^2 R_L)] = 4(12V)^2 / (2\pi^2 (8\Omega)) = 3.65W$$

Calculating Heatsink Thermal Resistance:

$$\theta_{SA} < [(T_J - T_A) / P_{DMAX}] - \theta_{JC} - \theta_{CS}$$

$$\theta_{SA} < 100^\circ C / 3.7W - 2.0^\circ C/W - 0.2^\circ C/W = 24.8^\circ C/W$$

Therefore the recommendation is to use 2.0×2.0 square inch of single-sided copper clad.

LAYOUT AND GROUND RETURNS

Proper PC board layout is essential for good circuit performance. When laying out a PC board for an audio power amplifier, particular attention must be paid to the routing of the output signal ground returns relative to the input signal and bias capacitor grounds. To prevent any ground loops, the ground returns for the output signals should be routed separately and brought together at the supply ground. The input signal grounds and the bias capacitor ground line should also be routed separately. The $0.1 \mu F$ high frequency supply bypass capacitor should be placed as close as possible to the IC.

PC BOARD LAYOUT-COMPOSITE

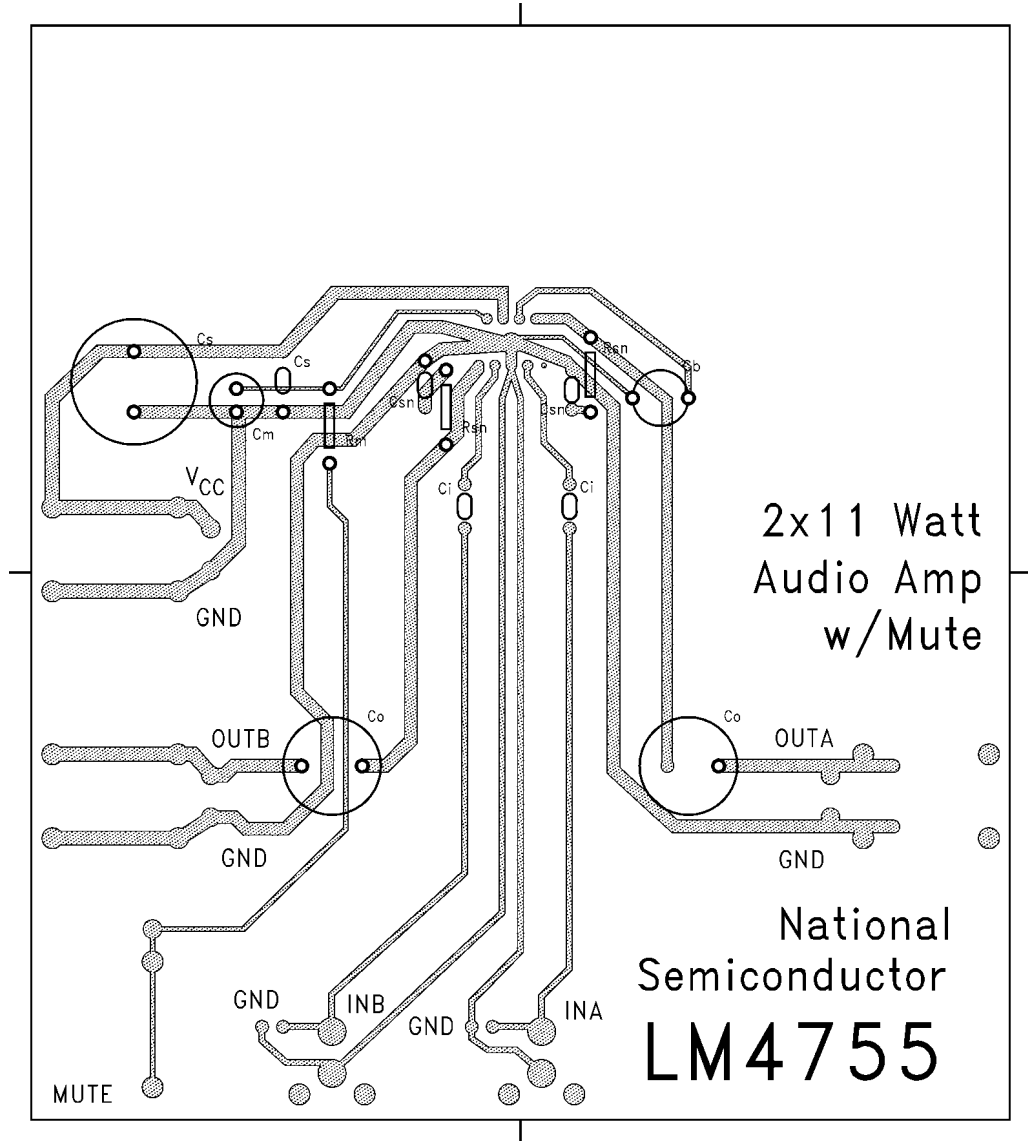

10005933

PC BOARD LAYOUT-SILK SCREEN

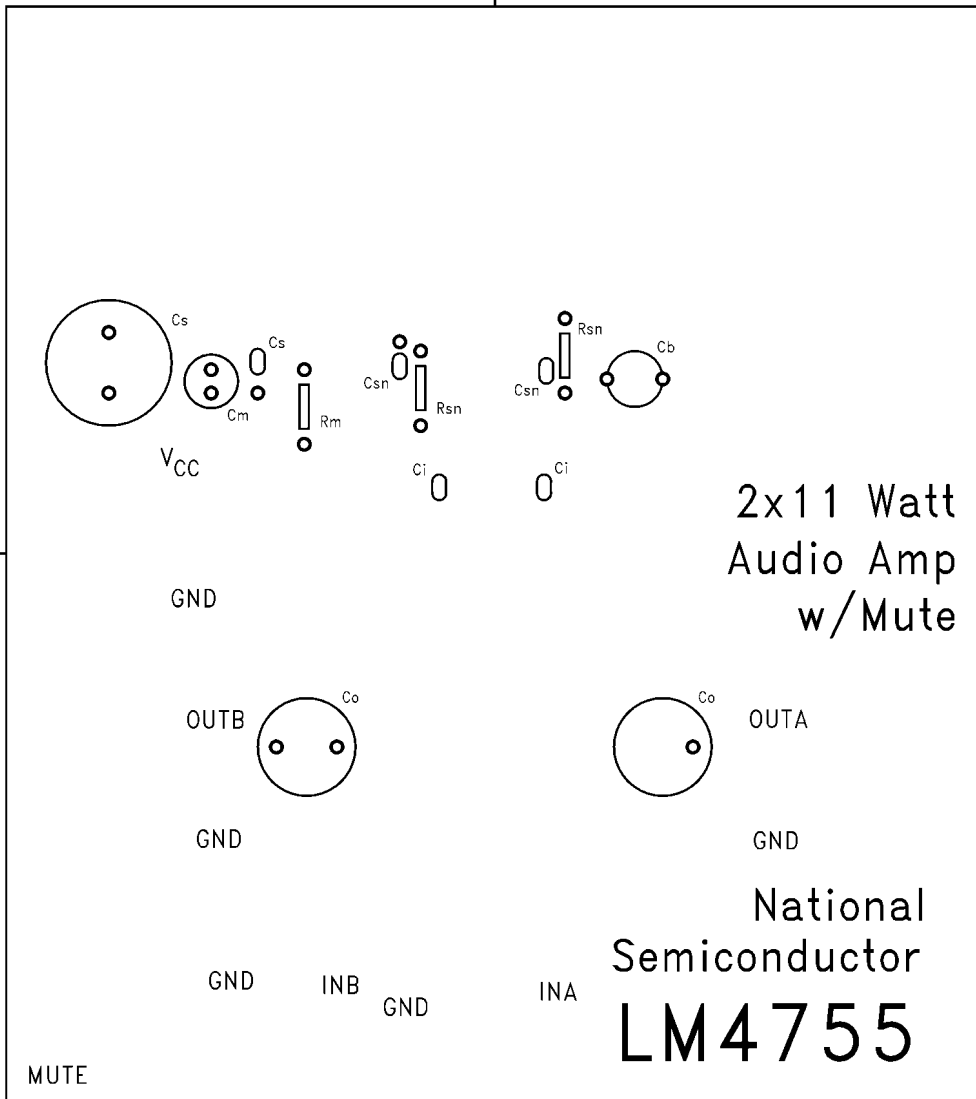

10005934

PC BOARD LAYOUT-SOLDER SIDE

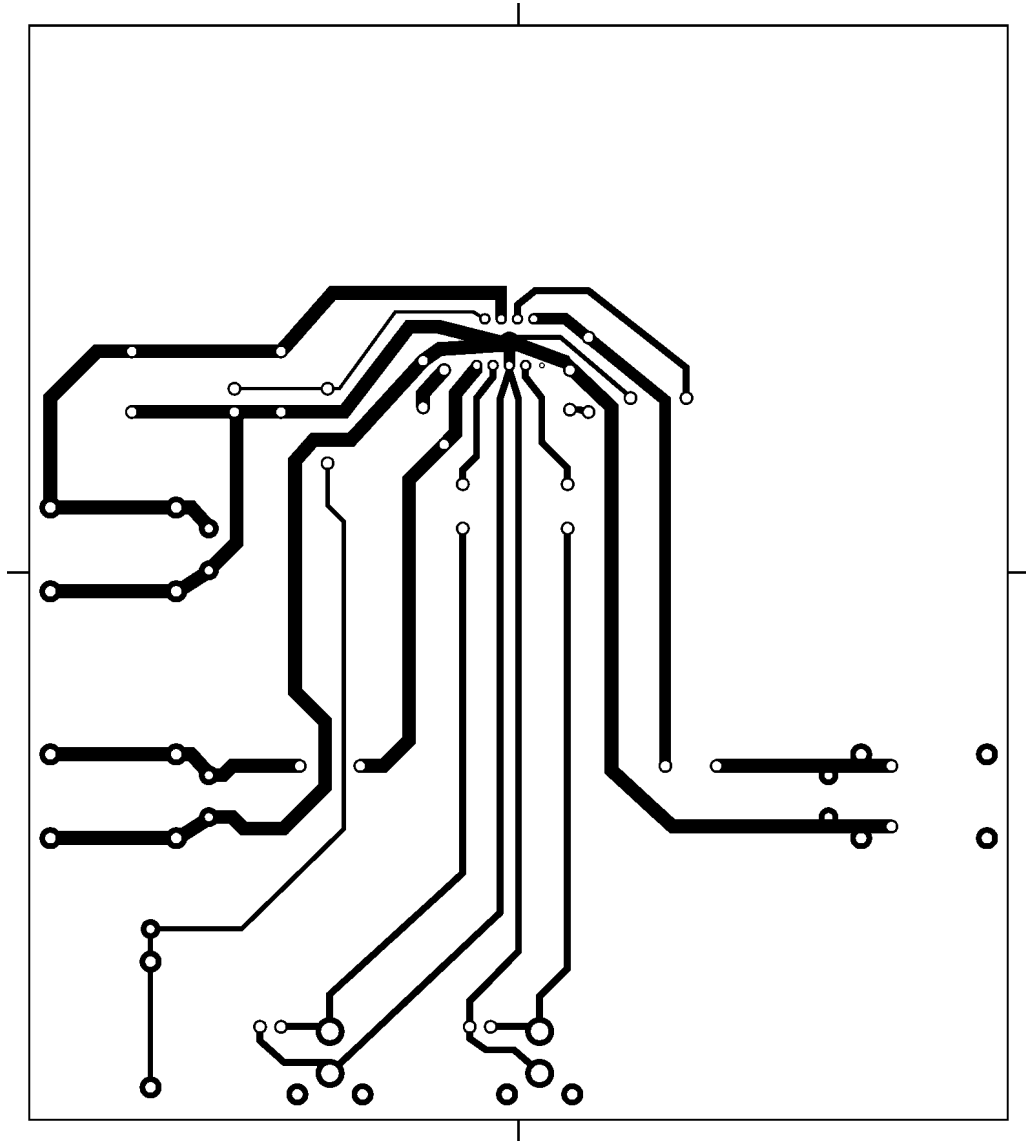

10005935

Physical Dimensions inches (millimeters) unless otherwise noted

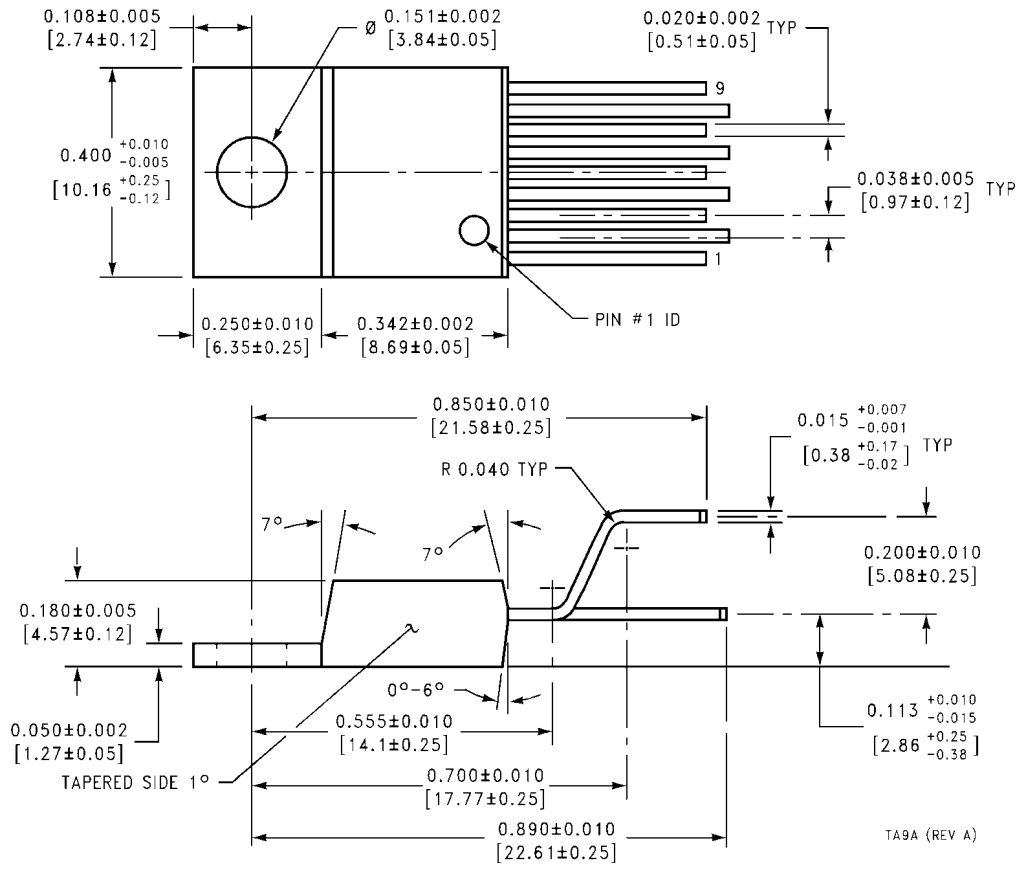

Order Number LM4755T
NS Package Number TA9A

TA9A (REV A)

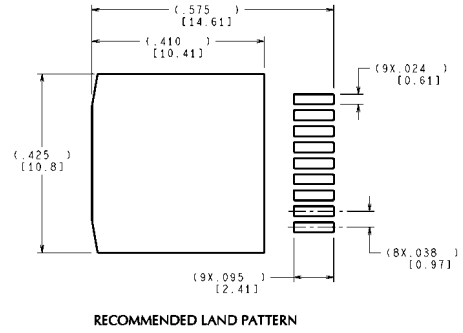
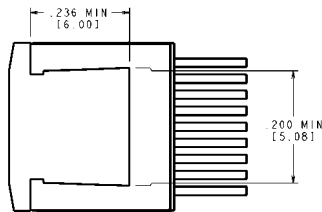
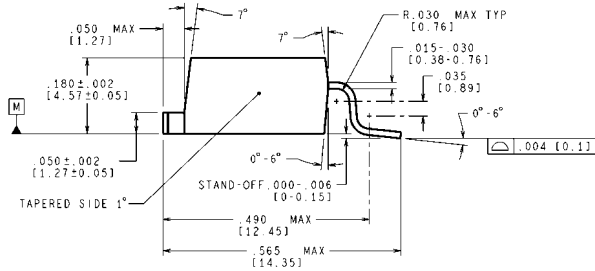
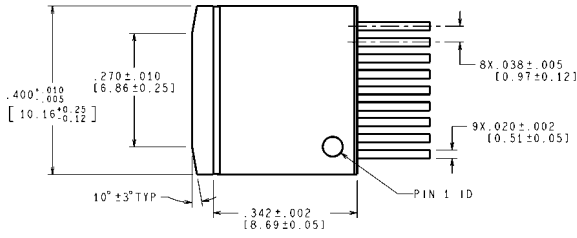

CONTROLLING DIMENSION: INCH
DIMENSIONS IN [] ARE MILLIMETERS

Order Number LM4755TS
NS Package Number TS9A

TS9A (Rev B)

Notes

LM4755

Notes

For more National Semiconductor product information and proven design tools, visit the following Web sites at:

Products		Design Support	
Amplifiers	www.national.com/amplifiers	WEBENCH	www.national.com/webench
Audio	www.national.com/audio	Analog University	www.national.com/AU
Clock Conditioners	www.national.com/timing	App Notes	www.national.com/appnotes
Data Converters	www.national.com/adac	Distributors	www.national.com/contacts
Displays	www.national.com/displays	Green Compliance	www.national.com/quality/green
Ethernet	www.national.com/ethernet	Packaging	www.national.com/packaging
Interface	www.national.com/interface	Quality and Reliability	www.national.com/quality
LVDS	www.national.com/lvds	Reference Designs	www.national.com/refdesigns
Power Management	www.national.com/power	Feedback	www.national.com/feedback
Switching Regulators	www.national.com/switchers		
LDOs	www.national.com/lldo		
LED Lighting	www.national.com/led		
PowerWise	www.national.com/powerwise		
Serial Digital Interface (SDI)	www.national.com/sdi		
Temperature Sensors	www.national.com/tempsensors		
Wireless (PLL/VCO)	www.national.com/wireless		

THE CONTENTS OF THIS DOCUMENT ARE PROVIDED IN CONNECTION WITH NATIONAL SEMICONDUCTOR CORPORATION ("NATIONAL") PRODUCTS. NATIONAL MAKES NO REPRESENTATIONS OR WARRANTIES WITH RESPECT TO THE ACCURACY OR COMPLETENESS OF THE CONTENTS OF THIS PUBLICATION AND RESERVES THE RIGHT TO MAKE CHANGES TO SPECIFICATIONS AND PRODUCT DESCRIPTIONS AT ANY TIME WITHOUT NOTICE. NO LICENSE, WHETHER EXPRESS, IMPLIED, ARISING BY ESTOPPEL OR OTHERWISE, TO ANY INTELLECTUAL PROPERTY RIGHTS IS GRANTED BY THIS DOCUMENT.

TESTING AND OTHER QUALITY CONTROLS ARE USED TO THE EXTENT NATIONAL DEEMS NECESSARY TO SUPPORT NATIONAL'S PRODUCT WARRANTY. EXCEPT WHERE MANDATED BY GOVERNMENT REQUIREMENTS, TESTING OF ALL PARAMETERS OF EACH PRODUCT IS NOT NECESSARILY PERFORMED. NATIONAL ASSUMES NO LIABILITY FOR APPLICATIONS ASSISTANCE OR BUYER PRODUCT DESIGN. BUYERS ARE RESPONSIBLE FOR THEIR PRODUCTS AND APPLICATIONS USING NATIONAL COMPONENTS. PRIOR TO USING OR DISTRIBUTING ANY PRODUCTS THAT INCLUDE NATIONAL COMPONENTS, BUYERS SHOULD PROVIDE ADEQUATE DESIGN, TESTING AND OPERATING SAFEGUARDS.

EXCEPT AS PROVIDED IN NATIONAL'S TERMS AND CONDITIONS OF SALE FOR SUCH PRODUCTS, NATIONAL ASSUMES NO LIABILITY WHATSOEVER, AND NATIONAL DISCLAIMS ANY EXPRESS OR IMPLIED WARRANTY RELATING TO THE SALE AND/OR USE OF NATIONAL PRODUCTS INCLUDING LIABILITY OR WARRANTIES RELATING TO FITNESS FOR A PARTICULAR PURPOSE, MERCHANTABILITY, OR INFRINGEMENT OF ANY PATENT, COPYRIGHT OR OTHER INTELLECTUAL PROPERTY RIGHT.

LIFE SUPPORT POLICY

NATIONAL'S PRODUCTS ARE NOT AUTHORIZED FOR USE AS CRITICAL COMPONENTS IN LIFE SUPPORT DEVICES OR SYSTEMS WITHOUT THE EXPRESS PRIOR WRITTEN APPROVAL OF THE CHIEF EXECUTIVE OFFICER AND GENERAL COUNSEL OF NATIONAL SEMICONDUCTOR CORPORATION. As used herein:

Life support devices or systems are devices which (a) are intended for surgical implant into the body, or (b) support or sustain life and whose failure to perform when properly used in accordance with instructions for use provided in the labeling can be reasonably expected to result in a significant injury to the user. A critical component is any component in a life support device or system whose failure to perform can be reasonably expected to cause the failure of the life support device or system or to affect its safety or effectiveness.

National Semiconductor and the National Semiconductor logo are registered trademarks of National Semiconductor Corporation. All other brand or product names may be trademarks or registered trademarks of their respective holders.

Copyright© 2008 National Semiconductor Corporation

For the most current product information visit us at www.national.com



National Semiconductor Americas Technical Support Center
Email: support@nsc.com
Tel: 1-800-272-9959

National Semiconductor Europe Technical Support Center
Email: europe.support@nsc.com
German Tel: +49 (0) 180 5010 771
English Tel: +44 (0) 870 850 4288

National Semiconductor Asia Pacific Technical Support Center
Email: ap.support@nsc.com

National Semiconductor Japan Technical Support Center
Email: jpn.feedback@nsc.com