

# LM4857 Boomer® Audio Power Amplifier Series

## Stereo 1.2W Audio Sub-system with 3D Enhancement

### General Description

The LM4857 is an integrated audio sub-system designed for stereo cell phone applications. Operating on a 3.3V supply, it combines a stereo speaker amplifier delivering 495mW per channel into an 8Ω load, a stereo headphone amplifier delivering 33mW per channel into a 32Ω load, a mono earpiece amplifier delivering 43mW into a 32Ω load, and a line output for an external powered handsfree speaker. It integrates the audio amplifiers, volume control, mixer, power management control, and National 3D enhancement all into a single package. In addition, the LM4857 routes and mixes the stereo and mono inputs into 16 distinct output modes. The LM4857 is controlled through an I<sup>2</sup>C compatible interface. Other features include an ultra-low current shutdown mode and thermal shutdown protection.

Boomer audio power amplifiers are designed specifically to provide high quality output power with a minimal amount of external components.

The LM4857 is available in a 30-bump ITL package and a 28-lead LLP package.

### Key Specifications

■ P <sub>OUT</sub> , Stereo Loudspeakers, 4Ω, 5V, 1% THD+N (LM4857SP)	1.6W (typ)
■ P <sub>OUT</sub> , Stereo Loudspeakers, 8Ω, 5V, 1% THD+N	1.2W (typ)
■ P <sub>OUT</sub> , Stereo Headphones, 32Ω, 5V, 1% THD+N	75mW (typ)
■ P <sub>OUT</sub> , Mono Earpiece, 32Ω, 5V, 1% THD+N	100mW (typ)
■ P <sub>OUT</sub> , Stereo Loudspeakers, 8Ω, 3.3V, 1% THD+N	495mW (typ)
■ P <sub>OUT</sub> , Stereo Headphones, 32Ω, 3.3V, 1% THD+N	33mW (typ)
■ P <sub>OUT</sub> , Mono Earpiece, 32Ω, 3.3V, 1% THD+N	43mW (typ)
■ Shutdown Current	0.06μA (typ)

### Features

- Stereo speaker amplifier
- Stereo headphone amplifier
- Mono earpiece amplifier
- Mono Line Output for external handsfree carkit
- Independent Left, Right, and Mono volume controls
- National 3D enhancement
- I<sup>2</sup>C compatible interface
- Ultra low shutdown current
- Click and Pop Suppression circuit
- 16 distinct output modes
- Thermal Shutdown Protection
- Available in micro SMD and LLP packages

### Applications

- Cell Phones
- PDAs
- Portable Gaming Devices
- Internet Appliances
- Portable DVD/CD/AAC/MP3 players

# Typical Application

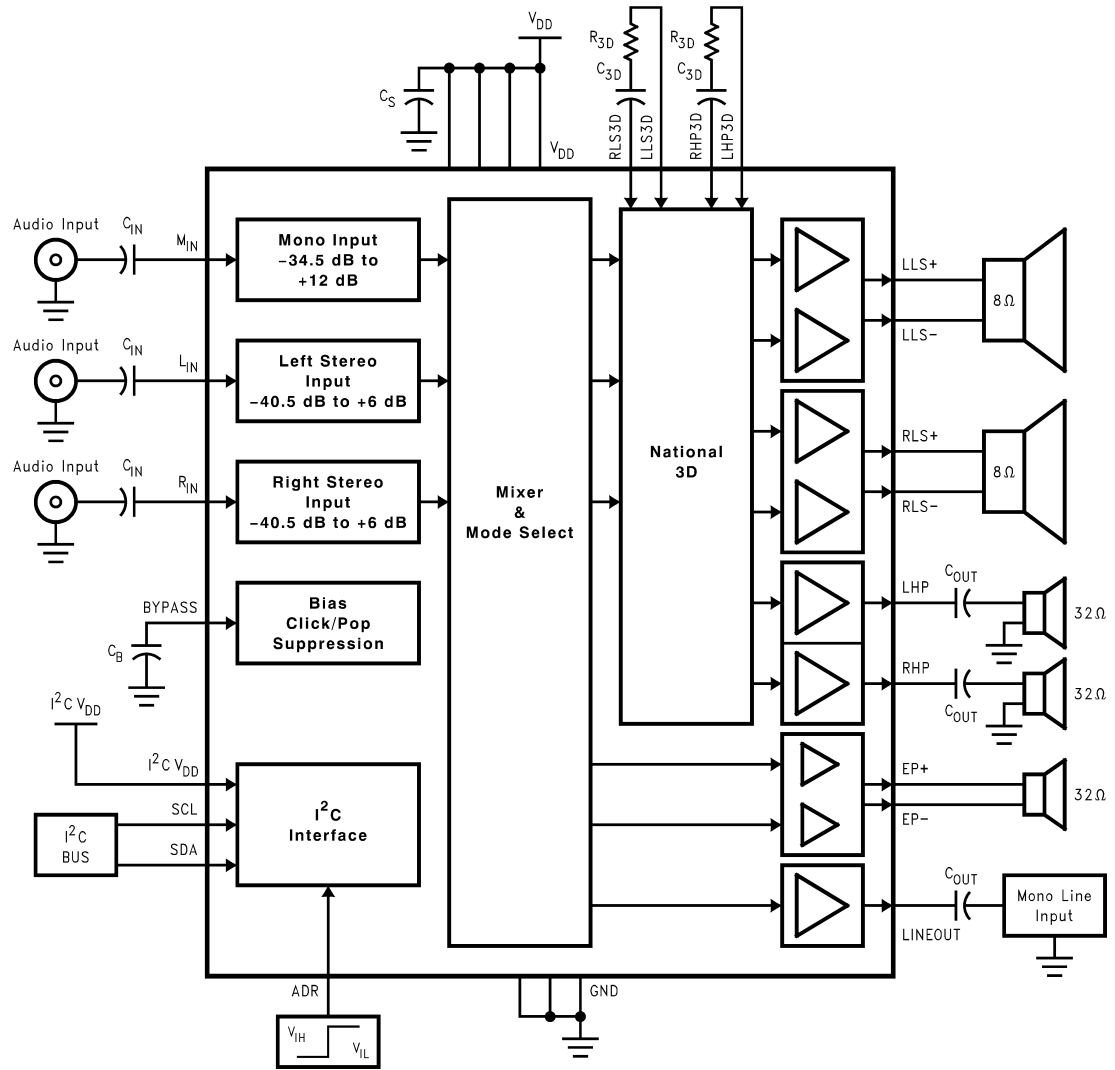

20079708

FIGURE 1. Typical Audio Amplifier Application Circuit

## Connection Diagrams

30 Bump ITL Package

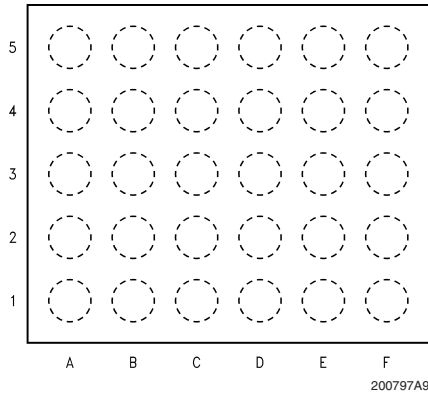

**Top View**  
(Bump-side down)  
Order Number LM4857ITL  
See NS Package Number TLA30CZA

micro SMD Marking

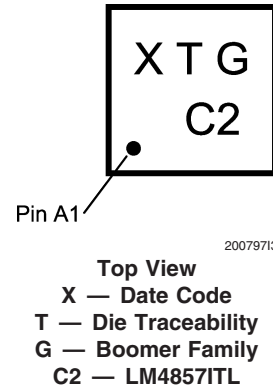

## Pin Connection (ITL)

Pin	Name	Pin Description
A1	RLS+	Right Loudspeaker Positive Output
A2	V <sub>DD</sub>	Power Supply
A3	SDA	Data
A4	RHP3D	Right Headphone 3D
A5	RHP	Right Headphone Output
B1	GND	Ground
B2	I <sup>2</sup> C V <sub>DD</sub>	I <sup>2</sup> C Interface Power Supply
B3	ADR	I <sup>2</sup> C Address Select
B4	LHP3D	Left Headphone 3D
B5	V <sub>DD</sub>	Power Supply
C1	RLS-	Right Loudspeaker Negative Output
C2	NC	No Connect
C3	SCL	Clock
C4	LINEOUT	Mono Line Output
C5	GND	Ground
D1	LLS-	Left Loudspeaker Negative Output
D2	V <sub>DD</sub>	Power Supply
D3	M <sub>IN</sub>	Mono Input
D4	NC	No Connect
D5	EP+	Mono Earpiece Positive Output
E1	GND	Ground
E2	BYPASS	Half-supply bypass
E3	LLS3D	Left Loudspeaker 3D
E4	R <sub>IN</sub>	Right Stereo Input
E5	EP-	Mono Earpiece Negative Output
F1	LLS+	Left Loudspeaker Positive Output
F2	V <sub>DD</sub>	Power Supply
F3	RLS3D	Right Loudspeaker 3D
F4	L <sub>IN</sub>	Left Stereo Input
F5	LHP	Left Headphone Output

# Connection Diagram

## 28 – Lead SP Package

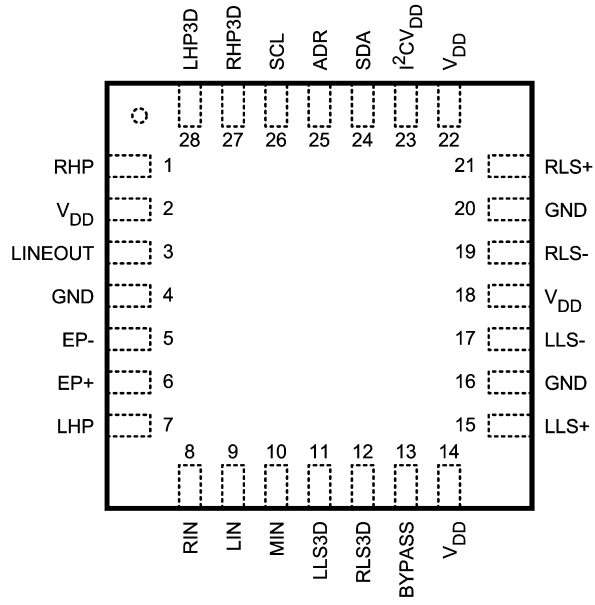

20079799

**Top View**  
**Order Number LM4857SP**  
**See NS Package Number SPA28A**

## Pin Connection (SP)

Pin	Name	Pin Description
1	RHP	Right Headphone Output
2	V <sub>DD</sub>	Power Supply
3	LINEOUT	Mono Line Output
4	GND	Ground
5	EP-	Mono Earpiece Negative Output
6	EP+	Mono Earpiece Positive Output
7	LHP	Left Headphone Output
8	RIN	Right Stereo Input
9	LIN	Left Stereo Input
10	MIN	Mono Input
11	LLS3D	Left Loudspeaker 3D
12	RLS3D	Right Loudspeaker 3D
13	BYPASS	Half-supply bypass
14	V <sub>DD</sub>	Power Supply
15	LLS+	Left Loudspeaker Positive Output
16	GND	Ground
17	LLS-	Left Loudspeaker Negative Output
18	V <sub>DD</sub>	Power Supply
19	RLS-	Right Loudspeaker Negative Output
20	GND	Ground
21	RLS+	Right Loudspeaker Positive Output
22	V <sub>DD</sub>	Power Supply
23	I <sup>2</sup> C V <sub>DD</sub>	I <sup>2</sup> C Interface Power Supply
24	SDA	Data
25	ADR	I <sup>2</sup> C Address Select
26	SCL	Clock
27	RHP3D	Right Headphone 3D
28	LHP3D	Left Headphone 3D

**Absolute Maximum Ratings** (Notes 1, 2)

If Military/Aerospace specified devices are required, please contact the National Semiconductor Sales Office/Distributors for availability and specifications.

Supply Voltage	6.0V
Storage Temperature	-65°C to +150°C
Input Voltage	-0.3V to $V_{DD}$ +0.3V
Power Dissipation (Note 3)	Internally Limited
ESD Susceptibility (Note 4)	2000V
ESD Susceptibility (Note 5)	200V
Junction Temperature ( $T_J$ )	150°C
Thermal Resistance	

 $\theta_{JA}$  (TLA30CZA) (Note 10)

62°C/W

 $\theta_{JA}$  (SPA28A) (Note 12)

42°C/W

 $\theta_{JC}$  (SPA28A)

3°C/W

**Operating Ratings**

Temperature Range

 $T_{MIN} \leq T_A \leq T_{MAX}$  $-40^\circ\text{C} \leq T_A \leq +85^\circ\text{C}$ 

Supply Voltage

 $2.7\text{V} \leq V_{DD} \leq 5.5\text{V}$  $2.5\text{V} \leq I^2\text{C}V_{DD} \leq 5.5\text{V}$ **Audio Amplifier Electrical Characteristics**  $V_{DD} = 5.0\text{V}$  (Notes 1, 2)The following specifications apply for  $V_{DD} = 5.0\text{V}$ , unless otherwise specified. Limits apply for  $T_A = 25^\circ\text{C}$ .

Symbol	Parameter	Conditions	LM4857		Units (Limits)
			Typical (Note 6)	Limits (Notes 7, 8)	
$I_{DD}$	Supply Current	$V_{IN} = 0\text{V}$ , No load; LD5 = RD5 = 0 (Note 9)			
		Mode 1, 6, 11	6	9.5	mA (max)
		Mode 4, 5, 9, 10, 14, 15	5	8	mA (max)
		Mode 2, 3, 7, 8, 12, 13	13	21	mA (max)
$I_{SD}$	Shutdown Current	Output mode 0 (Note 9)	0.2	3	$\mu\text{A}$ (max)
$P_O$	Output Power	LM4857SP Speaker; THD+N = 1%; $f = 1\text{kHz}$ ; 4 $\Omega$ BTL	1.6		W
		Speaker; THD+N = 1%; $f = 1\text{kHz}$ ; 8 $\Omega$ BTL	1.2	0.9	W (min)
		Headphone; THD+N = 1%; $f = 1\text{kHz}$ ; 32 $\Omega$ SE	75	60	mW (min)
		Earpiece; THD+N = 1%; $f = 1\text{kHz}$ ; 32 $\Omega$ BTL, CD4 = 0	100	80	mW (min)
		Earpiece; THD+N = 1%; $f = 1\text{kHz}$ ; 32 $\Omega$ BTL, CD4 = 1	135		mW
THD+N	Total Harmonic Distortion Plus Noise	LD5 = RD5 = 0			
		Speaker; $P_O = 400\text{mW}$ ; $f = 1\text{kHz}$ ; 8 $\Omega$ BTL	0.05		%
		Headphone; $P_O = 15\text{mW}$ ; $f = 1\text{kHz}$ ; 32 $\Omega$ SE	0.04		%
		Earpiece; $P_O = 15\text{mW}$ ; $f = 1\text{kHz}$ ; 32 $\Omega$ BTL, CD4 = 0	0.05		%
		Line Out, $V_O = 1V_{RMS}$ ; $f = 1\text{kHz}$ ; 5k $\Omega$ SE	0.009		%
$V_{OS}$	Offset Voltage	Speaker; LD5 = RD5 = 0	5	40	mV (max)
		Earpiece; LD5 = RD5 = 0	5	30	mV (max)

### Audio Amplifier Electrical Characteristics $V_{DD} = 5.0V$ (Notes 1, 2) (Continued)

The following specifications apply for  $V_{DD} = 5.0V$ , unless otherwise specified. Limits apply for  $T_A = 25^\circ C$ .

Symbol	Parameter	Conditions	LM4857		Units (Limits)
			Typical (Note 6)	Limits (Notes 7, 8)	
$N_{OUT}$	Output Noise	A-weighted, 0dB gain; (Note 11) LD5 = RD5 = 0; Audio Inputs Terminated			
		Speaker; Mode 2, 3, 7, 8	27		$\mu V$
		Speaker; Mode 12, 13	38		$\mu V$
		Headphone; Mode 3, 4, 8, 9	10		$\mu V$
		Headphone; Mode 13, 14	14		$\mu V$
		Earpiece; Mode 1; CD4 = 0	13		$\mu V$
		Earpiece; Mode 6	18		$\mu V$
		Earpiece; Mode 11	21		$\mu V$
		Line Out; Mode 5	11		$\mu V$
		Line Out; Mode 10	14		$\mu V$
		Line Out; Mode 15	17		$\mu V$
PSRR	Power Supply Rejection Ratio	$f = 217Hz$ ; $V_{rip} = 200mV_{pp}$ ; $C_B = 2.2\mu F$ ; 0dB gain; (Note 11) LD5 = RD5 = 0; Audio Inputs Terminated			
		Speaker; Mode 2, 3, 7, 8	70		dB
		Speaker; Mode 12, 13,	64	54	dB (min)
		Headphone; Mode 3, 4, 8, 9	86		dB
		Headphone; Mode 13, 14	73	60	dB (min)
		Earpiece; Mode1	75		dB
		Earpiece; Mode 6	70		dB
		Earpiece; Mode 11	66	57	dB (min)
		Line Out; Mode 5	86		dB
		Line Out; Mode 10	74		dB
Line Out; Mode 15	68	57	dB (min)		
Xtalk	Crosstalk	LD5 = RD5 = 0			
		Loudspeaker; $P_O = 400mW$ ; $f = 1kHz$	85		dB
		Headphone; $P_O = 15mW$ ; $f = 1kHz$	85		dB
$T_{WU}$	Wake-up Time	CD5 = 0; $C_B = 2.2\mu F$	120		ms
		CD5 = 1; $C_B = 2.2\mu F$	230		ms

### Audio Amplifier Electrical Characteristics $V_{DD} = 3.0V$ (Notes 1, 2)

The following specifications apply for  $V_{DD} = 3.0V$ , unless otherwise specified. Limits apply for  $T_A = 25^\circ C$ .

Symbol	Parameter	Conditions	LM4857		Units (Limits)
			Typical (Note 6)	Limits (Notes 7, 8)	
$I_{DD}$	Supply Current	$V_{IN} = 0V$ , No load; LD5 = RD5 = 0 (Note 9)			
		Mode 1, 6, 11	5.5	9	mA (max)
		Mode 4, 5, 9, 10, 14, 15	4.5	7.5	mA (max)
		Mode 2, 3, 7, 8, 12, 13	11.2	19	mA (max)
$I_{SD}$	Shutdown Current	Mode 0 (Note 9)	0.06	2.5	$\mu A$ (max)
$P_O$	Output Power	LM4857SP Speaker; THD+N = 1%; $f = 1kHz$ ; 4 $\Omega$ BTL	530		mW

## Audio Amplifier Electrical Characteristics $V_{DD} = 3.0V$ (Notes 1, 2) (Continued)

The following specifications apply for  $V_{DD} = 3.0V$ , unless otherwise specified. Limits apply for  $T_A = 25^\circ C$ .

Symbol	Parameter	Conditions	LM4857		Units (Limits)
			Typical (Note 6)	Limits (Notes 7, 8)	
$P_O$	Output Power	Speaker; THD+N = 1%; f = 1kHz; 8 $\Omega$ BTL	400	320	mW (min)
		Headphone; THD+N = 1%; f = 1kHz; 32 $\Omega$ SE	25	20	mW (min)
		Earpiece; THD+N = 1%; f = 1kHz; 32 $\Omega$ BTL; CD4 = 0	30	22	mW (min)
		Earpiece; THD+N = 1%; f = 1kHz; 32 $\Omega$ BTL; CD4 = 1	30		mW
THD+N	Total Harmonic Distortion Plus Noise	LD5 = RD5 = 0			
		Speaker; $P_O = 200mW$ ; f = 1kHz; 8 $\Omega$ BTL	0.05		%
		Headphone; $P_O = 10mW$ ; f = 1kHz; 32 $\Omega$ SE	0.04		%
		Earpiece; $P_O = 10mW$ ; f = 1kHz; 32 $\Omega$ BTL; CD4 = 0	0.06		%
		Line Out; $V_O = 1V_{RMS}$ ; f = 1kHz; 5k $\Omega$ SE	0.015		%
$V_{OS}$	Offset Voltage	Speaker; LD5 = RD5 = 0	5	40	mV (max)
		Earpiece; LD5 = RD5 = 0	5	30	mV (max)
$N_{OUT}$	Output Noise	A-weighted; 0dB gain; (Note 11) LD5 = RD5 = 0; All Inputs Terminated			
		Speaker; Mode 2, 3, 7, 8	27		$\mu V$
		Speaker; Mode 12, 13	38		$\mu V$
		Headphone; Mode 3, 4, 8, 9	10		$\mu V$
		Headphone; Mode 13, 14	14		$\mu V$
		Earpiece; Mode 1	13		$\mu V$
		Earpiece; Mode 6	18		$\mu V$
		Earpiece; Mode 11	21		$\mu V$
		Line Out; Mode 5	11		$\mu V$
		Line Out; Mode 10	14		$\mu V$
PSRR	Power Supply Rejection Ratio	f = 217Hz, $V_{rip} = 200mV_{pp}$ ; $C_B = 2.2\mu F$ ; 0dB gain; (Note 11) LD5 = RD5 = 0; All Audio Inputs Terminated			
		Speaker; Mode 2, 3, 7, 8	70		dB
		Speaker; Mode 12, 13,	65	55	dB (min)
		Headphone; Mode 3, 4, 8, 9	87		dB
		Headphone; Mode 13, 14	75	62	dB (min)
		Earpiece; Mode1	76		dB
		Earpiece; Mode 6	70		dB
		Earpiece; Mode 11	67	57	dB (min)
		Line Out; Mode 5	88		dB
		Line Out; Mode 10	74		dB
		71	58	dB (min)	



## Audio Amplifier Electrical Characteristics $V_{DD} = 3.0V$ (Notes 1, 2) (Continued)

The following specifications apply for  $V_{DD} = 3.0V$ , unless otherwise specified. Limits apply for  $T_A = 25^\circ C$ .

Symbol	Parameter	Conditions	LM4857		Units (Limits)
			Typical (Note 6)	Limits (Notes 7, 8)	
Xtalk	Crosstalk	LD5 = RD5 = 0			
		Loudspeaker; $P_O = 200mW$ ; $f = 1kHz$	82		dB
		Headphone; $P_O = 10mW$ ; $f = 1kHz$	82		dB
T <sub>WU</sub>	Wake-up Time	CD5 = 0; $C_B = 2.2\mu F$	80		ms
		CD5 = 1; $C_B = 2.2\mu F$	140		ms

## Volume Control Electrical Characteristics (Notes 1, 2)

The following specifications apply for  $V_{DD} = 5.0V$  and  $V_{DD} = 3.0V$ , unless otherwise specified. Limits apply for  $T_A = 25^\circ C$ .

Symbol	Parameter	Conditions	LM4857		Units (Limits)
			Typical (Note 6)	Limits (Notes 7, 8)	
	Stereo Volume Control Range	maximum gain setting	6	5.5 6.5	dB (min) dB (max)
		minimum gain setting	-40.5	-41 -40	dB (min) dB (max)
	Mono Volume Control Range	maximum gain setting	12	11.5 12.5	dB (min) dB (max)
		minimum gain setting	-34.5	-35 -34	dB (min) dB (max)
	Volume Control Step Size		1.5		dB
	Volume Control Step Size Error		+/-0.2	+/-0.5	dB (max)
	Stereo Channel to Channel Gain Mismatch		0.3		dB
	Mute Attenuation	Mode 12, $V_{in} = 1V_{RMS}$			
		Headphone	85		dB
		Line Out	85		dB
	$L_{IN}$ and $R_{IN}$ Input Impedance	maximum gain setting	33.5	25 42	k $\Omega$ (min) k $\Omega$ (max)
		minimum gain setting	100	75 125	k $\Omega$ (min) k $\Omega$ (max)
	$M_{IN}$ Input Impedance	maximum gain setting	20	15 25	k $\Omega$ (min) k $\Omega$ (max)
		minimum gain setting	98	73 123	k $\Omega$ (min) k $\Omega$ (max)

## Control Interface Electrical Characteristics (Notes 1, 2)

The following specifications apply for  $V_{DD} = 5V$  and  $V_{DD} = 3V$  and  $2.5V \leq I^2CV_{DD} \leq 5.5V$ , unless otherwise specified. Limits apply for  $T_A = 25^\circ C$ .

Symbol	Parameter	Conditions	LM4857		Units (Limits)
			Typical (Note 6)	Limits (Notes 7, 8)	
t <sub>1</sub>	SCL period			2.5	$\mu s$ (min)
t <sub>2</sub>	SDA Set-up Time			100	ns (min)
t <sub>3</sub>	SDA Stable Time			0	ns (min)
t <sub>4</sub>	Start Condition Time			100	ns (min)

## Control Interface Electrical Characteristics (Notes 1, 2) (Continued)

The following specifications apply for  $V_{DD} = 5V$  and  $V_{DD} = 3V$  and  $2.5V \leq I^2CV_{DD} \leq 5.5V$ , unless otherwise specified. Limits apply for  $T_A = 25^\circ C$ .

Symbol	Parameter	Conditions	LM4857		Units (Limits)
			Typical (Note 6)	Limits (Notes 7, 8)	
$t_5$	Stop Condition time			100	ns (min)
$V_{IH}$	Digital Input High Voltage			$0.7 \times I^2CV_{DD}$	V (min)
$V_{IL}$	Digital Input Low Voltage			$0.3 \times I^2CV_{DD}$	V (max)

**Note 1:** All voltages are measured with respect to the GND pin unless otherwise specified.

**Note 2:** Absolute Maximum Ratings indicate limits beyond which damage to the device may occur. Operating Ratings indicate conditions for which the device is functional but do not guarantee specific performance limits. Electrical Characteristics state DC and AC electrical specifications under particular test conditions which guarantee specific performance limits. This assumes that the device is within the Operating Ratings. Specifications are not guaranteed for parameters where no limit is given, however, the typical value is a good indication of device performance.

**Note 3:** The maximum power dissipation must be derated at elevated temperatures and is dictated by  $T_{JMAX}$ ,  $\theta_{JA}$ , and the ambient temperature,  $T_A$ . The maximum allowable power dissipation is  $P_{DMAX} = (T_{JMAX} - T_A) / \theta_{JA}$  or the number given in Absolute Maximum Ratings, whichever is lower. For the LM4857 operating in Mode 3, 8, or 13 with  $V_{DD} = 5V$ ,  $8\Omega$  stereo loudspeakers and  $32\Omega$  stereo headphones, the total power dissipation is 1.348W.  $\theta_{JA} = 62^\circ C/W$ .

**Note 4:** Human body model, 100pF discharged through a 1.5k $\Omega$  resistor.

**Note 5:** Machine Model, 220pF - 240pF discharged through all pins.

**Note 6:** Typicals are measured at  $+25^\circ C$  and represent the parametric norm.

**Note 7:** Limits are guaranteed to National's AOQL (Average Outgoing Quality Level).

**Note 8:** Datasheet min/max specification limits are guaranteed by design, test, or statistical analysis.

**Note 9:** Shutdown current and supply current are measured in a normal room environment. All digital input pins are connected to  $I^2CV_{DD}$ .

**Note 10:** The given  $\theta_{JA}$  is for an LM4857ITL mounted on a PCB with a  $2in^2$  area of 1oz printed circuit board copper ground plane.

**Note 11:** "0dB gain" refers to the volume control gain setting of  $M_{IN}$ ,  $L_{IN}$ , and  $R_{IN}$  set at 0dB.

**Note 12:** The given  $\theta_{JA}$  is for an LM4857SP mounted on a PCB with a  $2in^2$  area of 1oz printed circuit board ground plane.

## External Components Description

Components		Functional Description
1.	$C_{IN}$	This is the input coupling capacitor. It blocks the DC voltage and couples the input signal to the amplifier's input terminals. $C_{IN}$ also creates a highpass filter with the internal resistor $R_i$ (Input Impedance) at $f_c = 1/(2\pi R_i C_{IN})$ .
2.	$C_S$	This is the supply bypass capacitor. It filters the supply voltage applied to the $V_{DD}$ pin and helps reduce the noise at the $V_{DD}$ pin.
3.	$C_B$	This is the BYPASS pin capacitor. It filters the $V_{DD} / 2$ voltage and helps maintain the LM4857's PSRR.
4.	$C_{OUT}$	This is the output coupling capacitor. It blocks the DC voltage and couples the output signal to the speaker load $R_L$ . $C_{OUT}$ also creates a high pass filter with $R_L$ at $f_o = 1/(2\pi R_L C_{OUT})$ .
5.	$R_{3D}$	This resistor sets the gain of the National 3D effect. Please refer to the <b>National 3D Enhancement</b> section for information on selecting the value of $R_{3D}$ .
6.	$C_{3D}$	This capacitor sets the frequency at which the National 3D effect starts to occur. Please refer to the <b>National 3D Enhancement</b> section for information on selecting the value of $C_{3D}$ .

## Typical Performance Characteristics (Note 11)

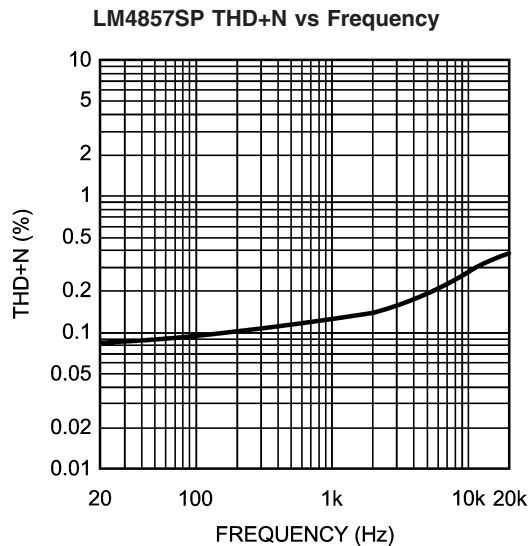

$V_{DD} = 5V$ ; LLS, RLS;  $P_O = 400mW$ ;  
 $R_L = 4\Omega$ ; Mode 7; 0dB Gain

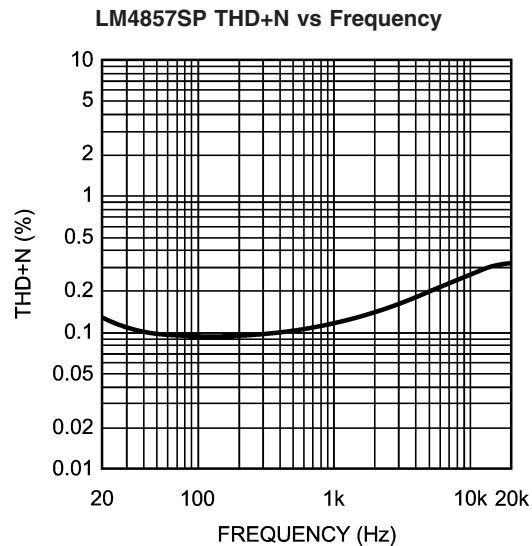

$V_{DD} = 3V$ ; LLS, RLS;  $P_O = 200mW$ ;  
 $R_L = 4\Omega$ ; Mode 7; 0dB Gain

Typical Performance Characteristics (Note 11) (Continued)

LM4857SP THD+N vs Output Power

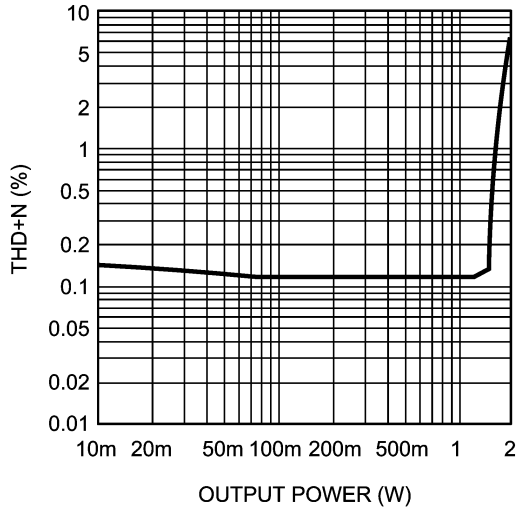

$V_{DD} = 5V$ ; LLS, RLS;  $f = 1kHz$ ;  
 $R_L = 4\Omega$ ; Mode 7; 0dB Gain

20079757

LM4857SP THD+N vs Output Power

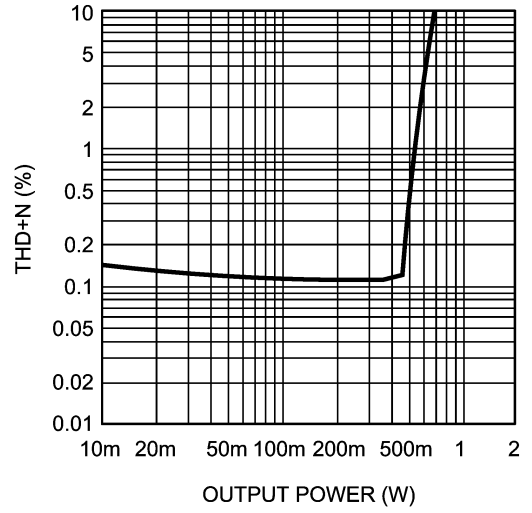

$V_{DD} = 3V$ ; LLS, RLS;  $f = 1kHz$ ;  
 $R_L = 4\Omega$ ; Mode 7; 0dB Gain

20079758

THD+N vs Frequency

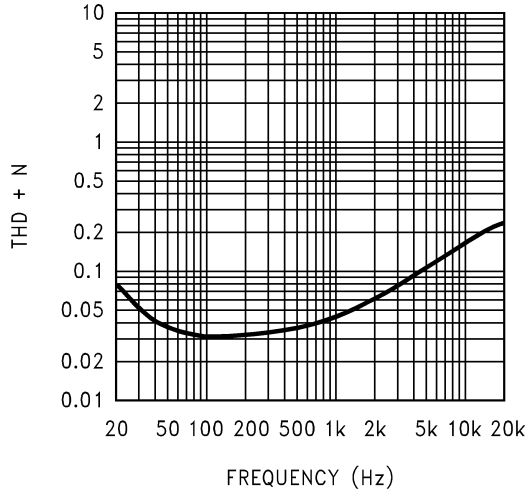

$V_{DD} = 5V$ ; LLS, RLS;  $P_O = 400mW$ ;  
 $R_L = 8\Omega$ ; Mode 7; 0dB Gain

20079710

THD+N vs Frequency

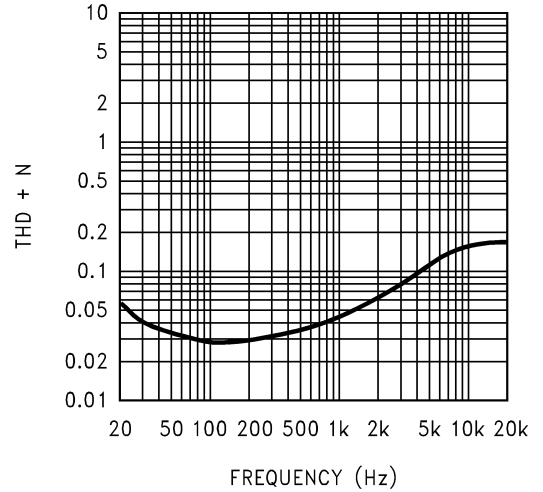

$V_{DD} = 3V$ ; LLS, RLS;  $P_O = 200mW$ ;  
 $R_L = 8\Omega$ ; Mode 7; 0dB Gain

20079711

Typical Performance Characteristics (Note 11) (Continued)

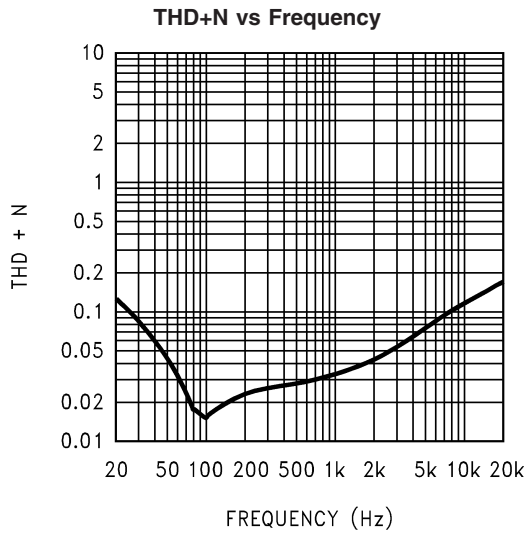

$V_{DD} = 5V$ ; LHP, RHP;  $P_O = 15mW$ ;  
 $R_L = 32\Omega$ ; Mode 9; 0dB Gain

20079712

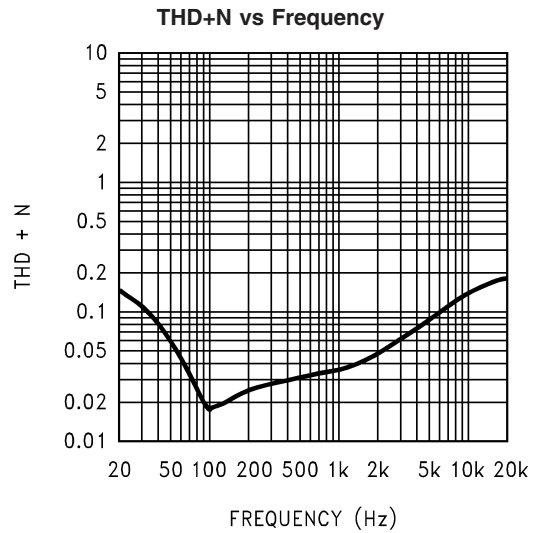

$V_{DD} = 3V$ ; LHP, RHP;  $P_O = 10mW$ ;  
 $R_L = 32\Omega$ ; Mode 9; 0dB Gain

20079713

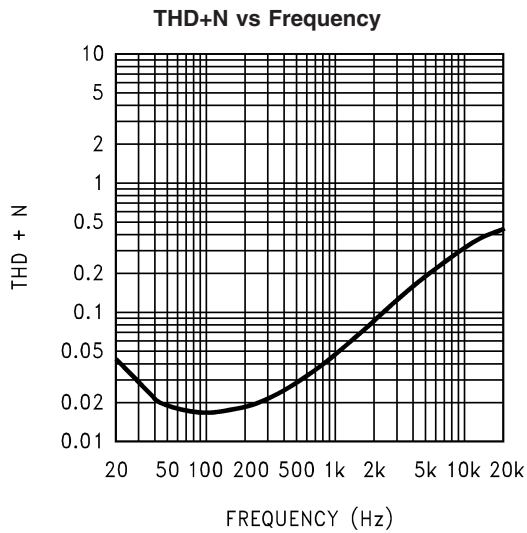

$V_{DD} = 5V$ ; EP;  $P_O = 15mW$ ;  
 $R_L = 32\Omega$ ; Mode 1; 0dB Gain, CD4 = 0

20079714

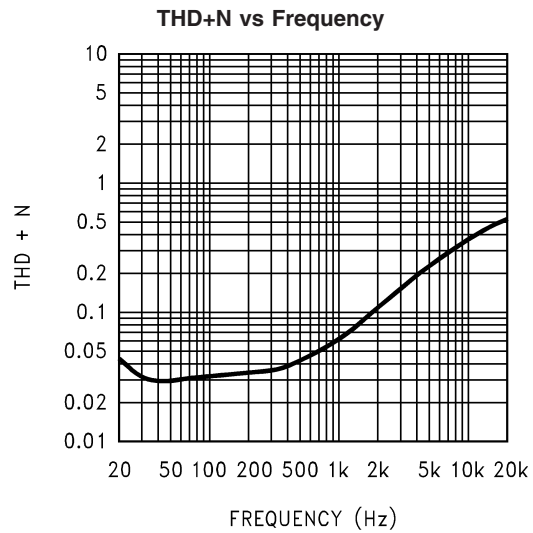

$V_{DD} = 3V$ ; EP;  $P_O = 10mW$ ;  
 $R_L = 32\Omega$ ; Mode 1; 0dB Gain, CD4 = 0

20079715

Typical Performance Characteristics (Note 11) (Continued)

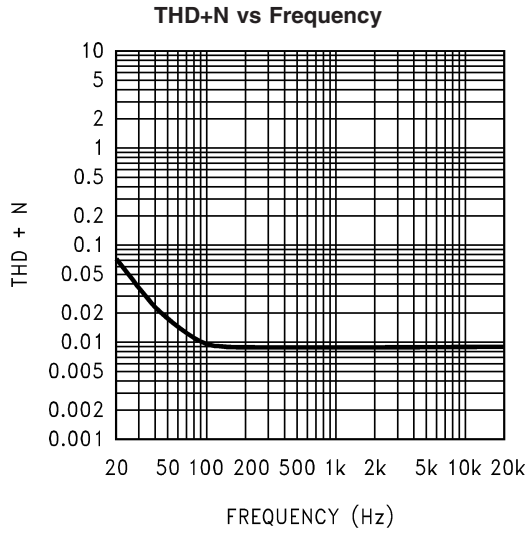

$V_{DD} = 5V$ ; LINEOUT;  $V_O = 1V_{RMS}$ ;  
 $R_L = 5k\Omega$ ; Mode 5; 0dB Gain

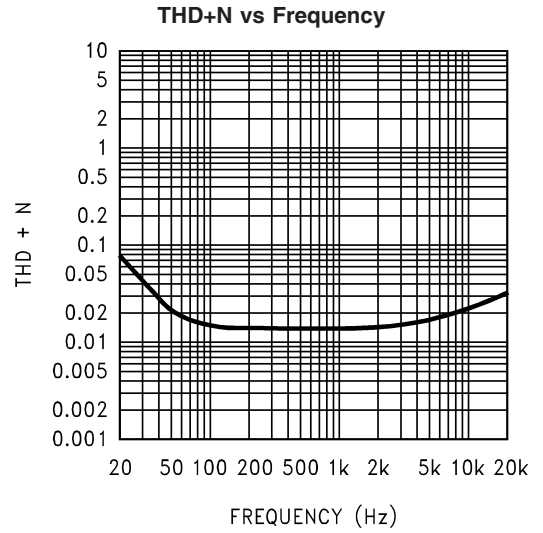

$V_{DD} = 3V$ ; LINEOUT;  $V_O = 1V_{RMS}$ ;  
 $R_L = 5k\Omega$ ; Mode 5; 0dB Gain

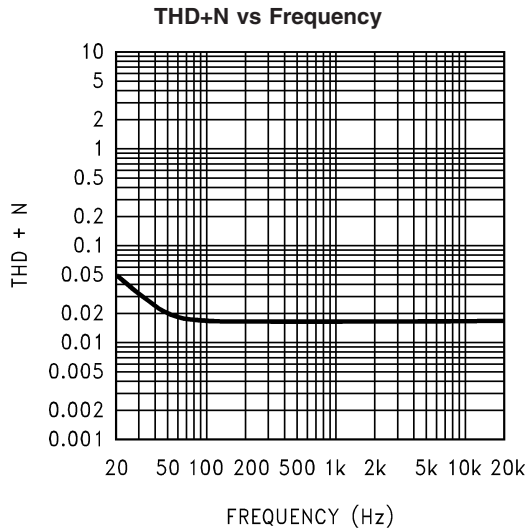

$V_{DD} = 5V$ ; LINEOUT;  $V_O = 1V_{RMS}$ ;  
 $R_L = 5k\Omega$ ; Mode 10; 0dB Gain

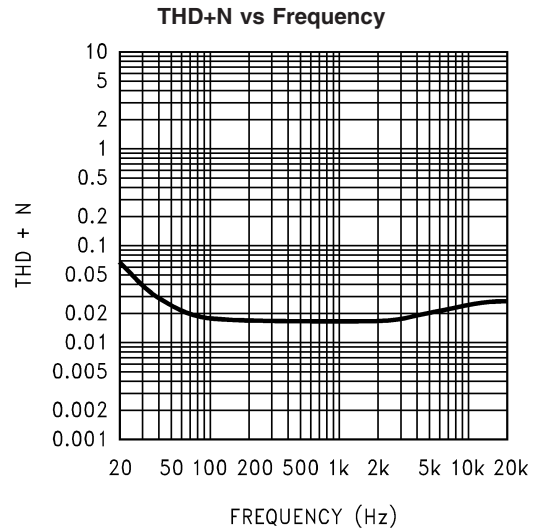

$V_{DD} = 3V$ ; LINEOUT;  $V_O = 1V_{RMS}$ ;  
 $R_L = 5k\Omega$ ; Mode 10; 0dB Gain

Typical Performance Characteristics (Note 11) (Continued)

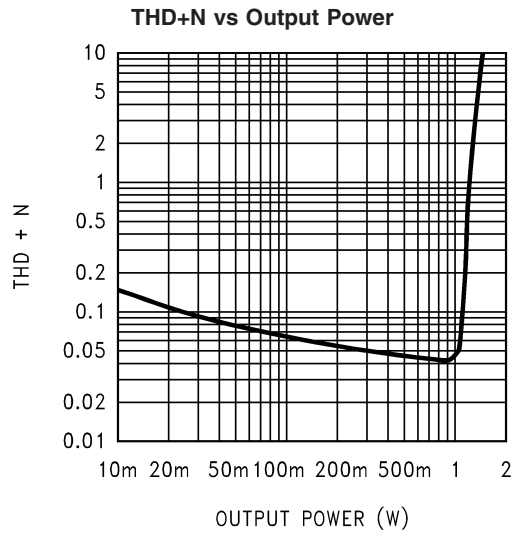

$V_{DD} = 5V$ ; LLS, RLS;  $f = 1kHz$ ;  
 $R_L = 8\Omega$ ; Mode 7; 0dB Gain

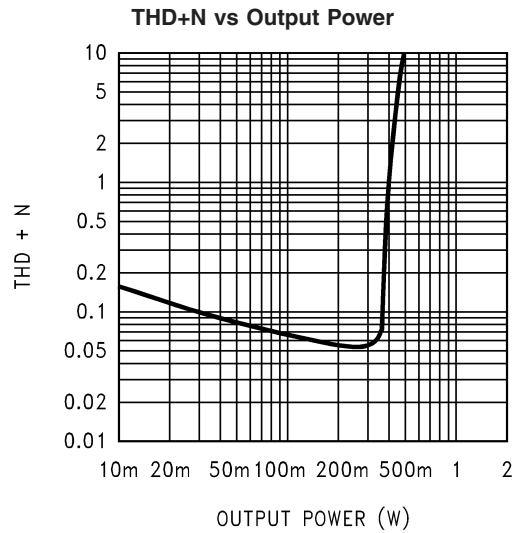

$V_{DD} = 3V$ ; LLS, RLS;  $f = 1kHz$ ;  
 $R_L = 8\Omega$ ; Mode 7; 0dB Gain

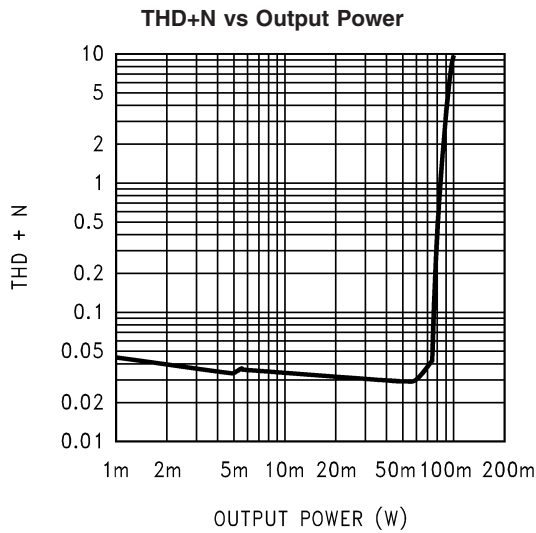

$V_{DD} = 5V$ ; LHP, RHP;  $f = 1kHz$ ;  
 $R_L = 32\Omega$ ; Mode 9; 0dB Gain

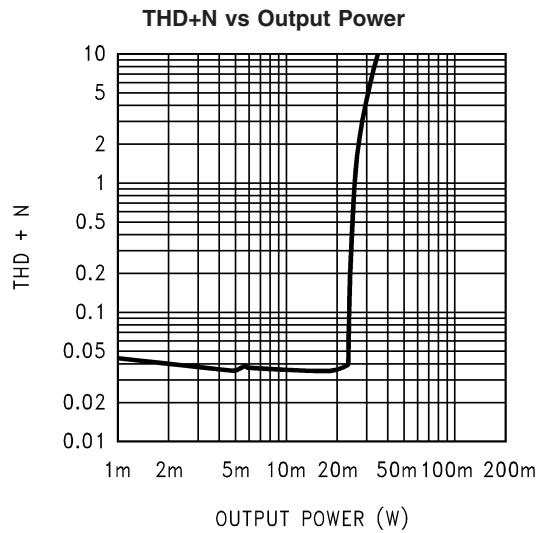

$V_{DD} = 3V$ ; LHP, RHP;  $f = 1kHz$ ;  
 $R_L = 32\Omega$ ; Mode 9; 0dB Gain

Typical Performance Characteristics (Note 11) (Continued)

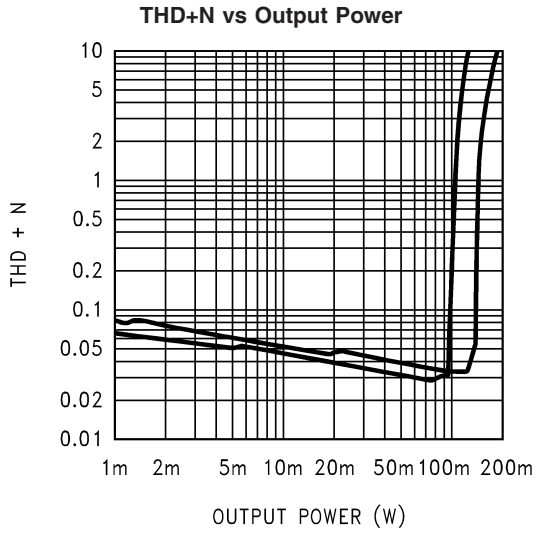

20079724

$V_{DD} = 5V$ ; EP;  $f = 1kHz$ ;  $R_L = 32\Omega$ ;  
Mode 1; 0dB Gain; Top-CD4 = 1; Bot-CD4 = 0

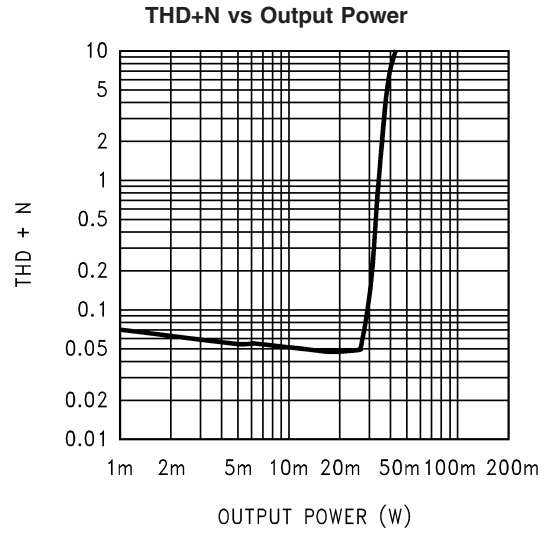

20079725

$V_{DD} = 3V$ ; EP;  $f = 1kHz$ ;  
 $R_L = 32\Omega$ ; Mode 1; 0dB Gain

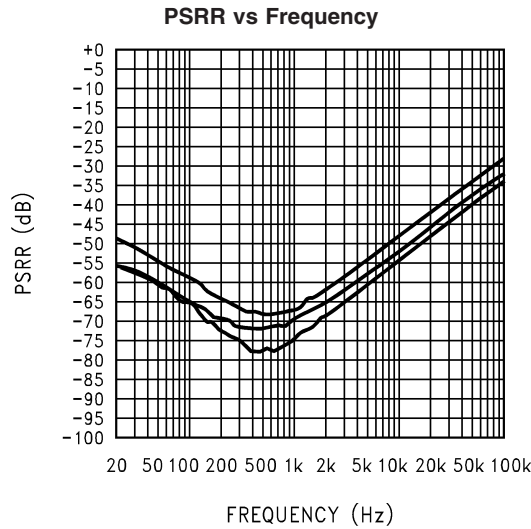

20079726

$V_{DD} = 5V$ ; LLS, RLS;  $R_L = 8\Omega$ ; 0db Gain;  
All audio inputs terminated  
Top-Mode 12, 13; Mid-Mode 2, 3; Bot-Mode 7, 8

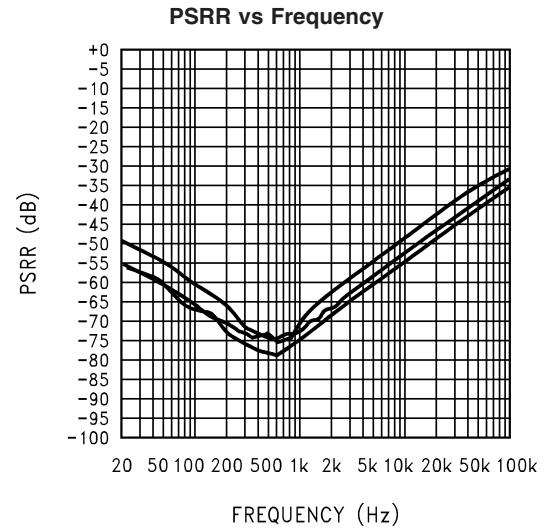

20079727

$V_{DD} = 3V$ ; LLS, RLS;  $R_L = 8\Omega$ ; 0db Gain;  
All audio inputs terminated  
Top-Mode 12, 13; Mid-Mode 2, 3; Bot-Mode 7, 8



Typical Performance Characteristics (Note 11) (Continued)

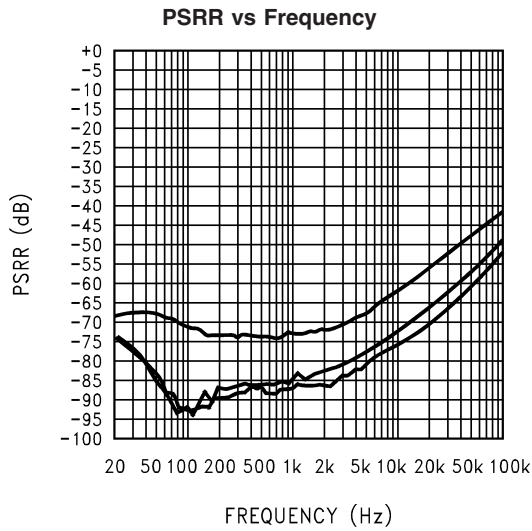

**$V_{DD} = 5V$ ; LHP, RHP;  $R_L = 32\Omega$ ; 0db Gain;  
All audio inputs terminated  
Top-Mode 13, 14; Mid-Mode 3, 4; Bot-Mode 8, 9**

20079728

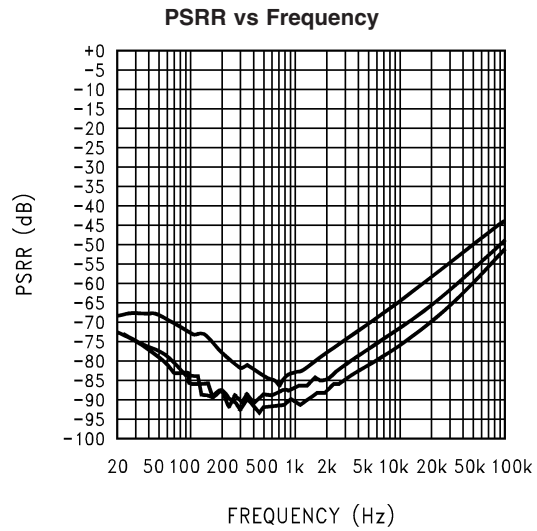

**$V_{DD} = 3V$ ; LHP, RHP;  $R_L = 32\Omega$ ; 0db Gain;  
All audio inputs terminated  
Top-Mode 13, 14; Mid-Mode 3, 4; Bot-Mode 8, 9**

20079729

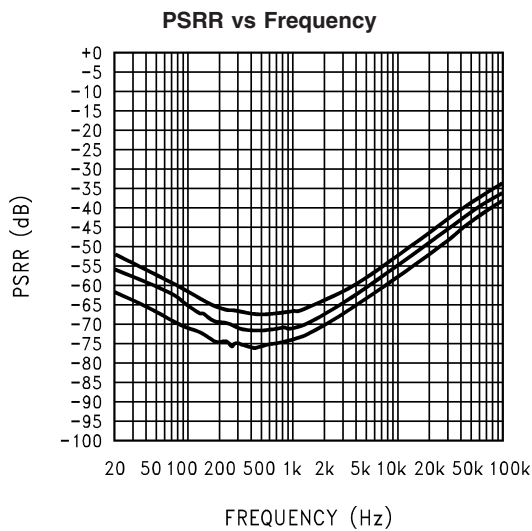

**$V_{DD} = 5V$ ; EP;  $R_L = 32\Omega$ ; 0db Gain;  
All audio inputs terminated  
Top-Mode 11; Mid-Mode 6; Bot-Mode 1**

20079730

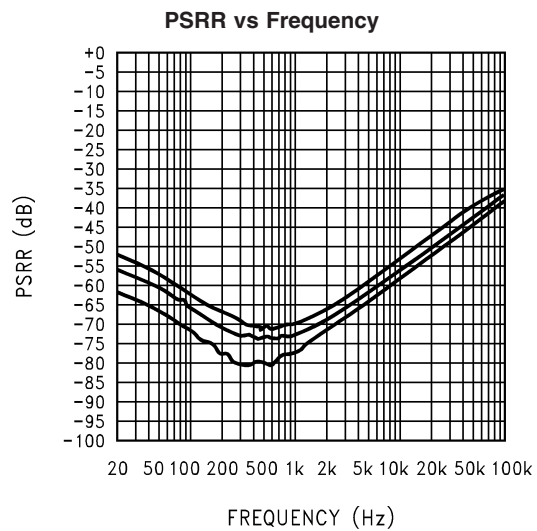

**$V_{DD} = 3V$ ; EP;  $R_L = 32\Omega$ ; 0db Gain;  
All audio inputs terminated  
Top-Mode 11; Mid-Mode 6; Bot-Mode 1**

20079731

Typical Performance Characteristics (Note 11) (Continued)

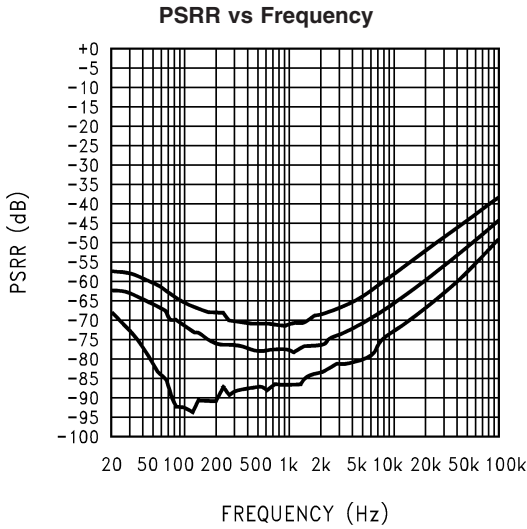

$V_{DD} = 5V$ ; LINEOUT;  $R_L = 5k\Omega$ ; 0db Gain;  
All audio inputs terminated  
Top-Mode 15; Mid-Mode 10; Bot-Mode 5

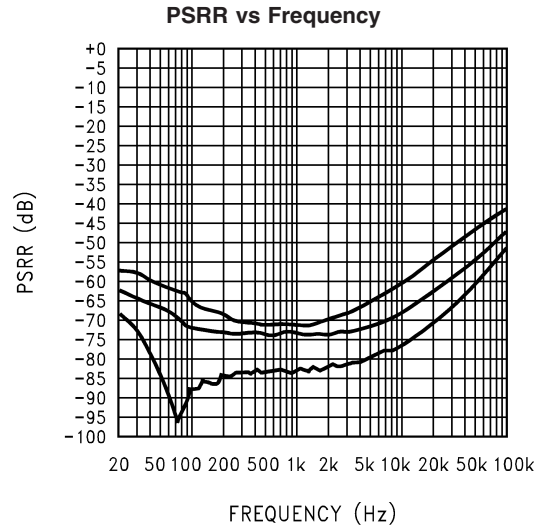

$V_{DD} = 3V$ ; LINEOUT;  $R_L = 5k\Omega$ ; 0db Gain;  
All audio inputs terminated  
Top-Mode 15; Mid-Mode 10; Bot-Mode 5

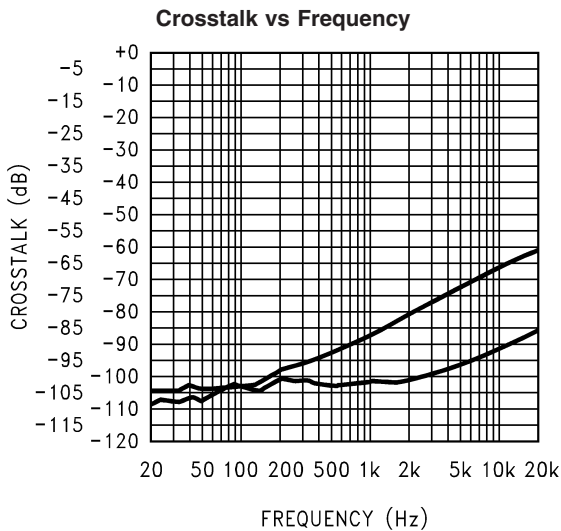

$V_{DD} = 5V$ ; LLS, RLS;  $P_O = 400mW$ ;  $R_L = 8\Omega$ ;  
Mode 7; 0db Gain; 3D off  
Top-Left to Right; Bot- Right to Left

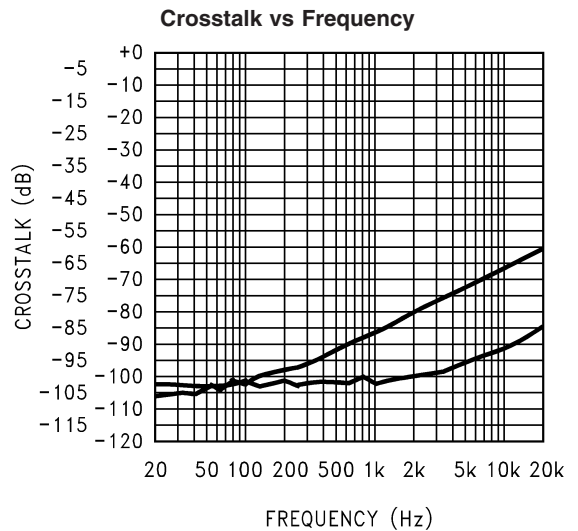

$V_{DD} = 3V$ ; LLS, RLS;  $P_O = 200mW$ ;  $R_L = 8\Omega$ ;  
Mode 7; 0db Gain; 3D off  
Top-Left to Right; Bot- Right to Left

Typical Performance Characteristics (Note 11) (Continued)

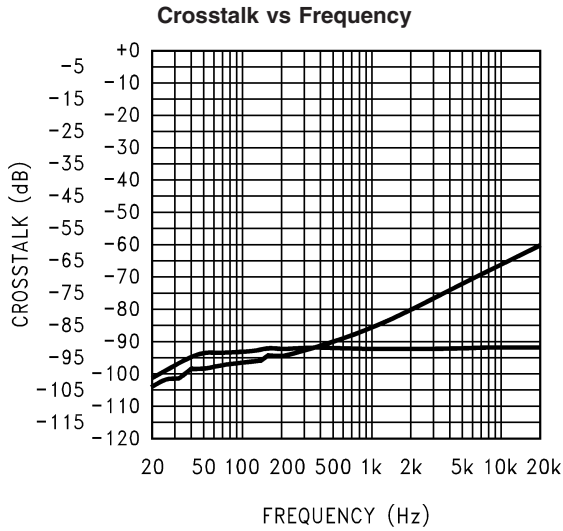

20079736  
 $V_{DD} = 5V$ ; LHP, RHP;  $P_O = 15mW$ ;  $R_L = 32\Omega$ ;  
 Mode 9; 0db Gain; 3D off  
 Top-Left to Right; Bot- Right to Left

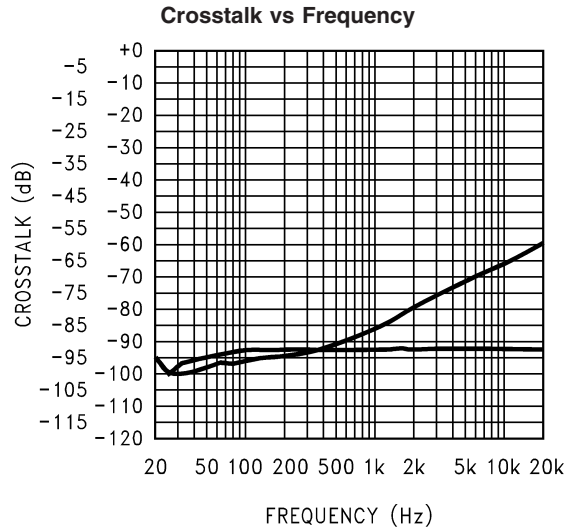

20079737  
 $V_{DD} = 3V$ ; LHP, RHP;  $P_O = 10mW$ ;  $R_L = 32\Omega$ ;  
 Mode 9; 0db Gain; 3D off  
 Top-Left to Right; Bot- Right to Left

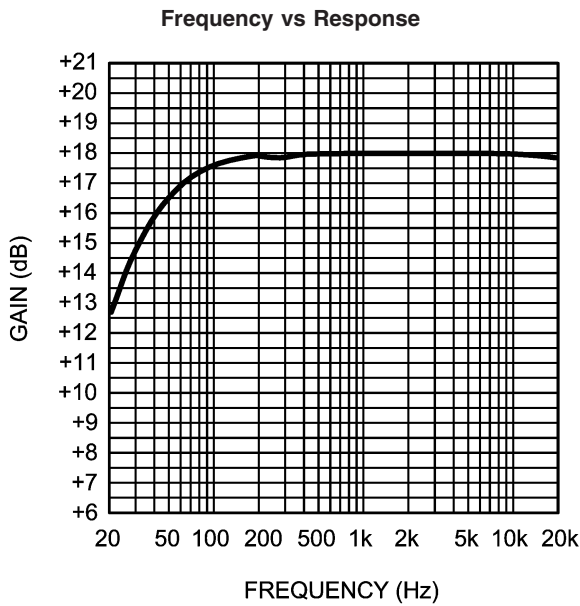

20079738  
 LLS, RLS;  $R_L = 8\Omega$ ;  
 Mode 2; Full Gain

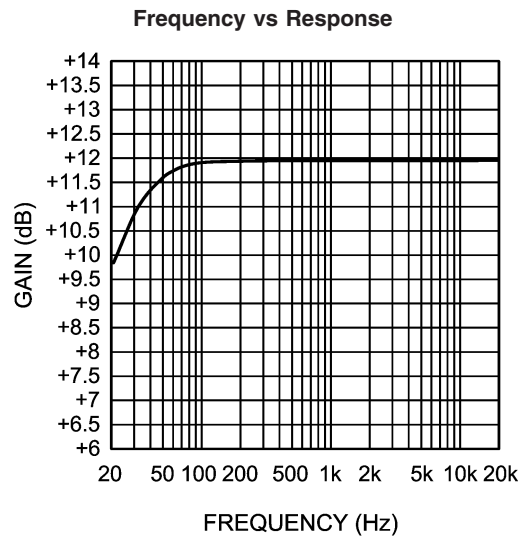

20079739  
 LLS, RLS;  $R_L = 8\Omega$ ;  
 Mode 7; Full Gain

Typical Performance Characteristics (Note 11) (Continued)

Frequency vs Response

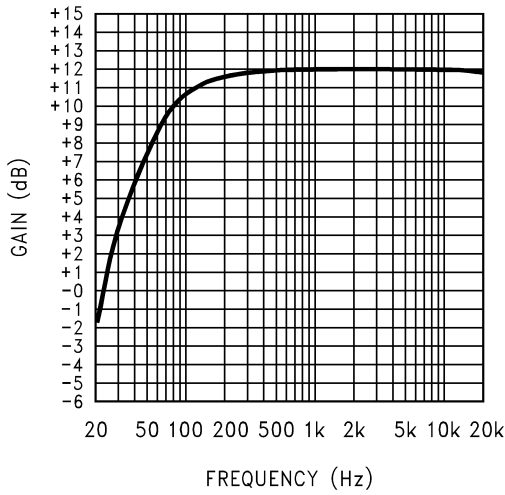

20079740

LHP, RHP;  $R_L = 32\Omega$ ;  $C_O = 100\mu F$   
Mode 4; Full Gain

Frequency vs Response

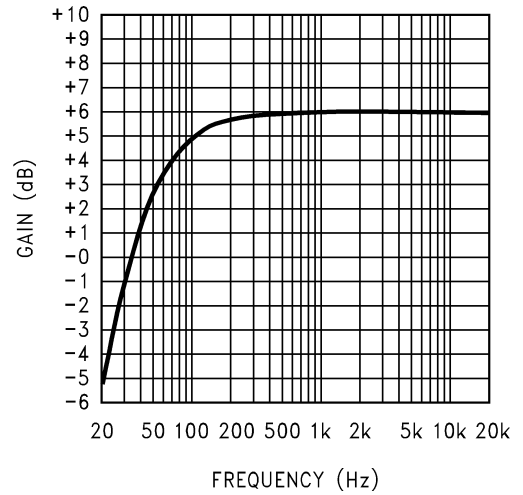

20079741

LHP, RHP;  $R_L = 32\Omega$ ;  $C_O = 100\mu F$   
Mode 9; Full Gain

Frequency vs Response

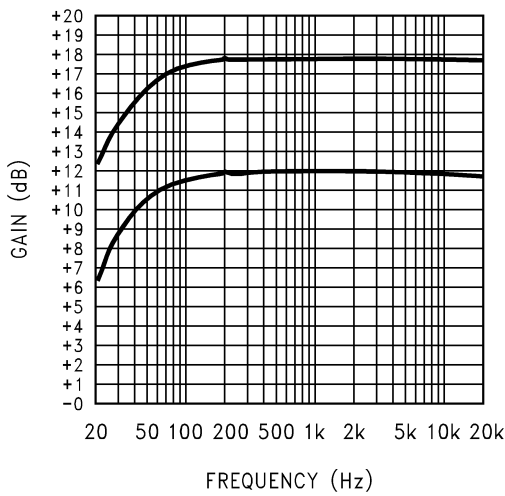

20079742

EP;  $R_L = 32\Omega$ ; Mode 1; Full Gain  
Top-CD4 = 1; Bot-CD4 = 0

Frequency vs Response

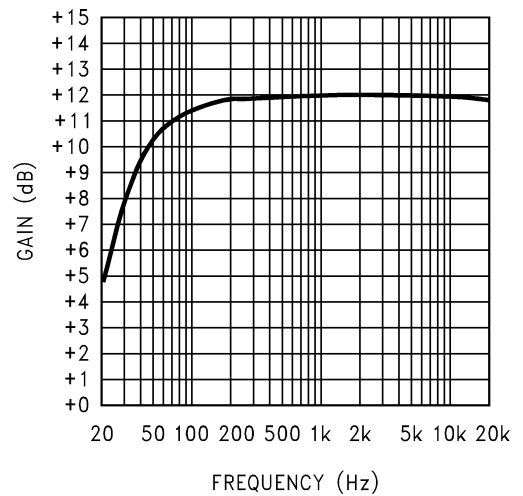

20079743

LINEOUT;  $R_L = 5k\Omega$ ;  $C_O = 2.2\mu F$   
Mode 5; Full Gain

Typical Performance Characteristics (Note 11) (Continued)

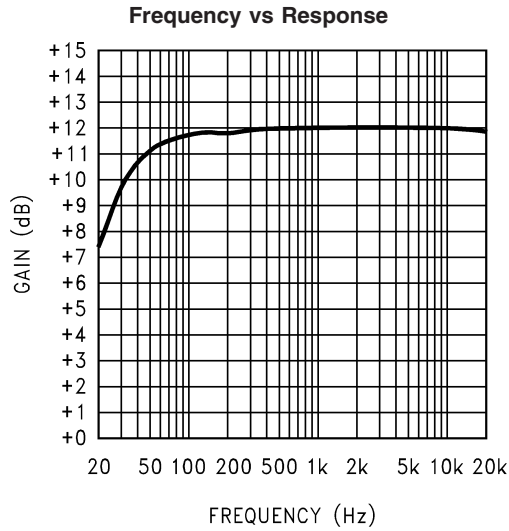

LINEOUT;  $R_L = 5k\Omega$ ;  $C_O = 2.2\mu F$   
Mode 10; Full Gain

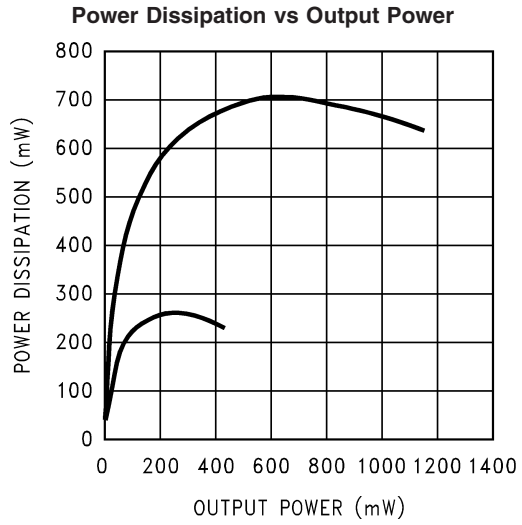

LLS, RLS;  $R_L = 8\Omega$ ; THD+N  $\leq 1\%$   
Top- $V_{DD} = 5V$ ; Bot- $V_{DD} = 3V$   
per channel

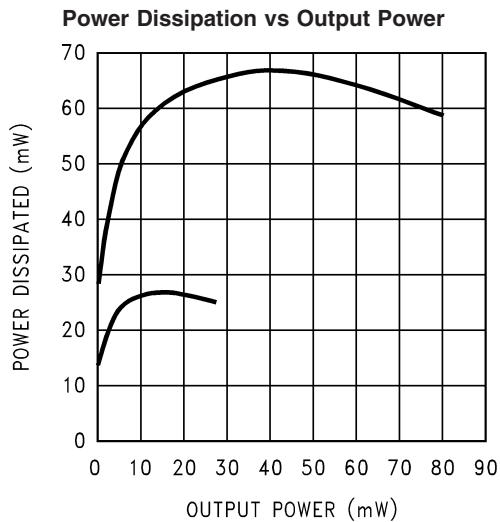

LHP, RHP;  $R_L = 32\Omega$ ; THD+N  $\leq 1\%$   
Top- $V_{DD} = 5V$ ; Bot- $V_{DD} = 3V$   
per channel

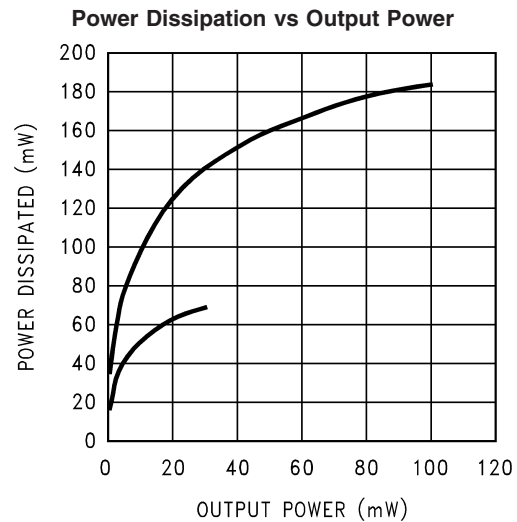

EP;  $R_L = 32\Omega$ ; THD+N  $\leq 1\%$   
Top- $V_{DD} = 5V$ ; Bot- $V_{DD} = 3V$

Typical Performance Characteristics (Note 11) (Continued)

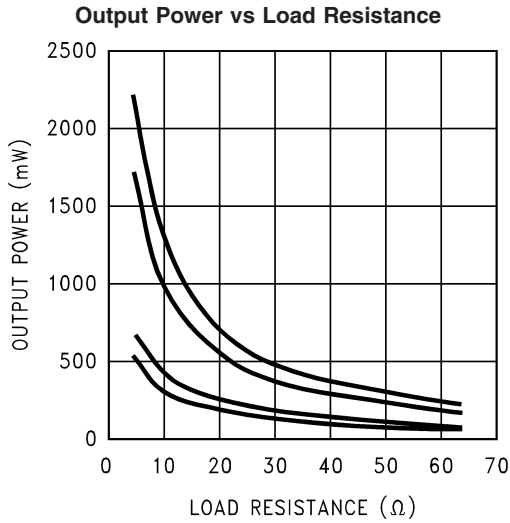

LLS, RLS;  $R_L = 8\Omega$ ;  
 Top- $V_{DD} = 5V$ , 10% THD+N; Topmid- $V_{DD} = 5V$ , 1% THD+N;  
 Botmid- $V_{DD} = 3V$ , 10% THD+N; Bot- $V_{DD} = 3V$ , 1% THD+N

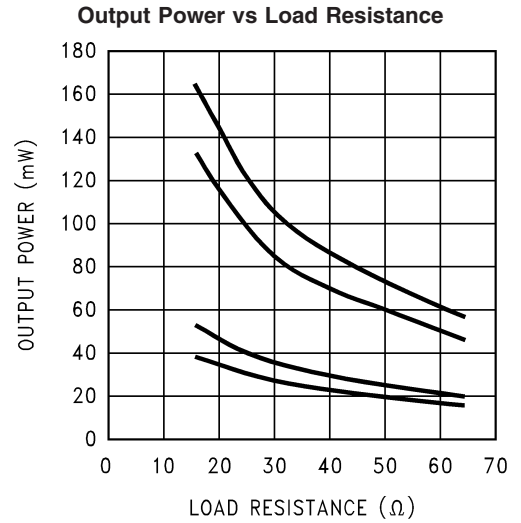

LHP, RHP;  $R_L = 32\Omega$ ;  
 Top- $V_{DD} = 5V$ , 10% THD+N; Topmid- $V_{DD} = 5V$ , 1% THD+N;  
 Botmid- $V_{DD} = 3V$ , 10% THD+N; Bot- $V_{DD} = 3V$ , 1% THD+N

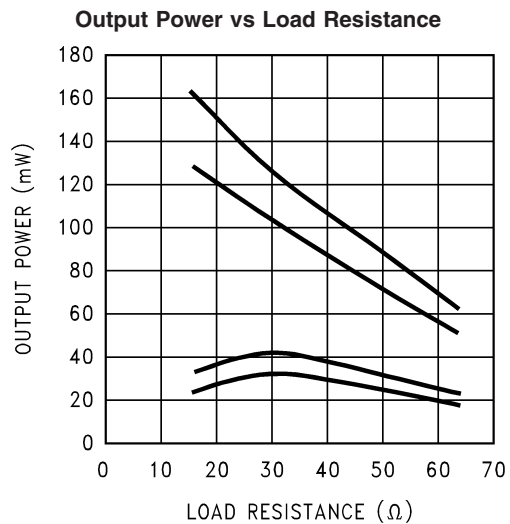

EP;  $R_L = 32\Omega$ ;  $CD4 = 0$   
 Top- $V_{DD} = 5V$ , 10% THD+N; Topmid- $V_{DD} = 5V$ , 1% THD+N;  
 Botmid- $V_{DD} = 3V$ , 10% THD+N; Bot- $V_{DD} = 3V$ , 1% THD+N

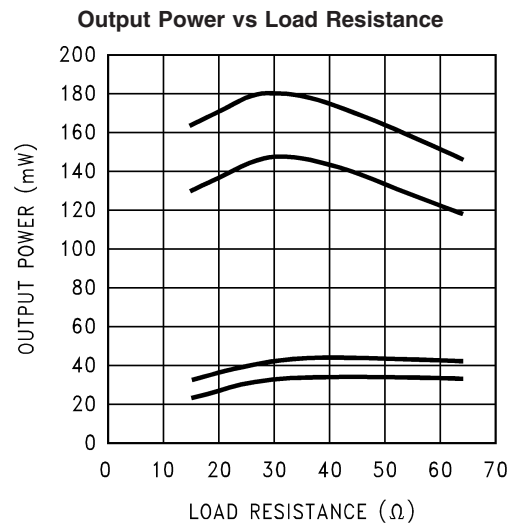

EP;  $R_L = 32\Omega$ ;  $CD4 = 1$   
 Top- $V_{DD} = 5V$ , 10% THD+N; Topmid- $V_{DD} = 5V$ , 1% THD+N;  
 Botmid- $V_{DD} = 3V$ , 10% THD+N; Bot- $V_{DD} = 3V$ , 1% THD+N

## Typical Performance Characteristics (Note 11) (Continued)

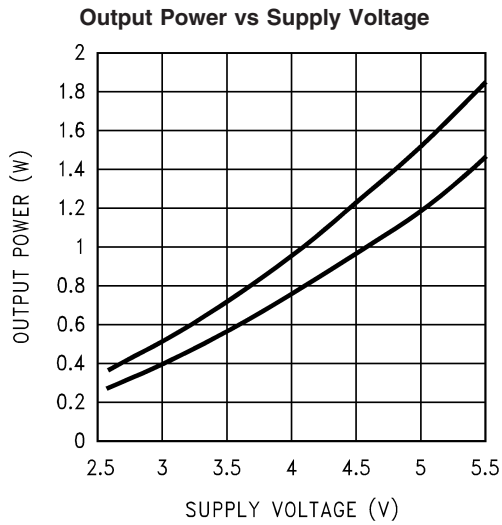

20079752

**LLS, RLS;  $R_L = 8\Omega$ ;  
Top-10% THD+N; Bot-1% THD+N**

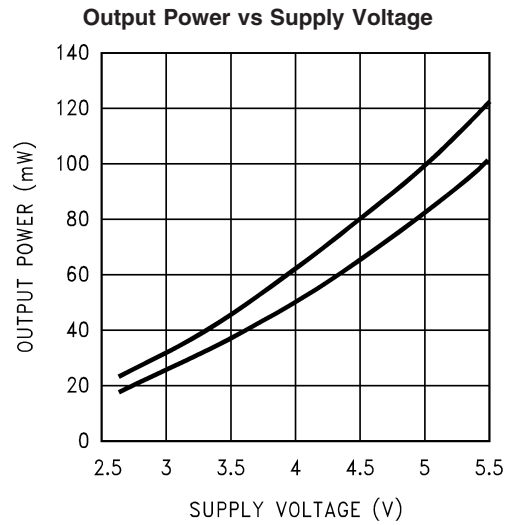

20079753

**LHP, RHP;  $R_L = 32\Omega$ ;  
Top-10% THD+N; Bot-1% THD+N**

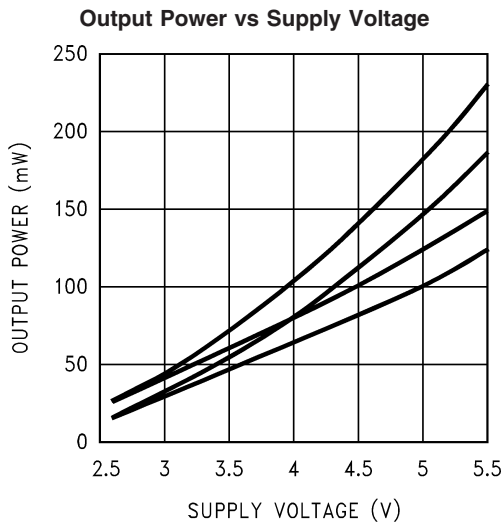

20079754

**EP;  $R_L = 32\Omega$ ;  
Top-10% THD+N; CD4 = 1; Topmid-1% THD+N, CD4 = 1  
Botmid-10% THD+N; CD4 = 0; Bot-1% THD+N, CD4 = 0**

## Application Information

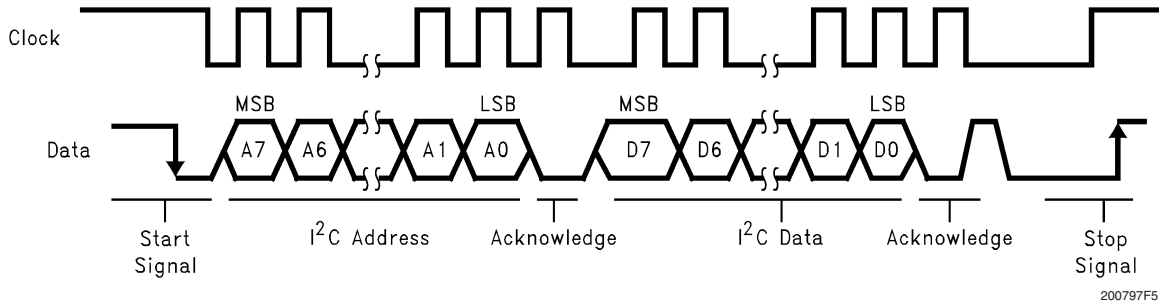

FIGURE 2. I<sup>2</sup>C Bus Format

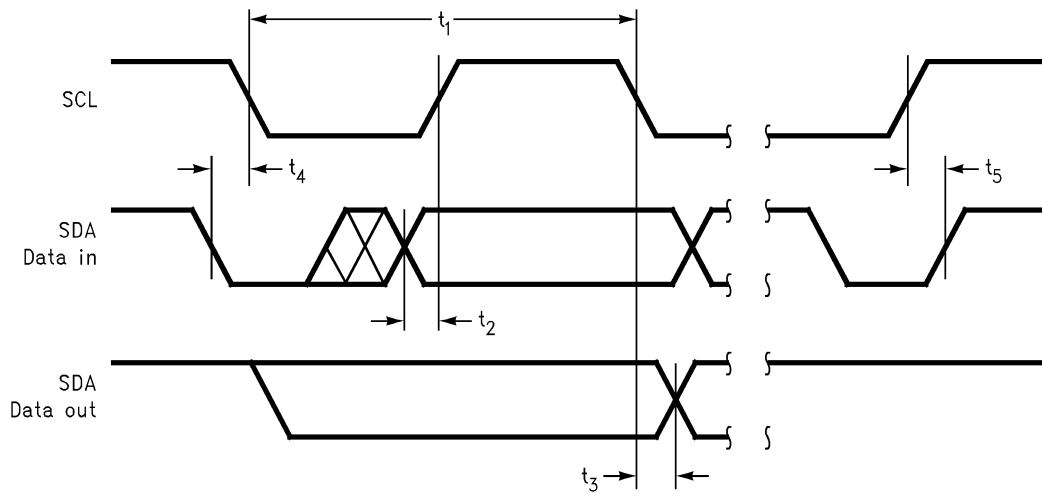

FIGURE 3. I<sup>2</sup>C Timing Diagram

TABLE 1. Chip Address

	A7	A6	A5	A4	A3	A2	A1	A0
Chip Address	1	1	1	1	1	0	EC	0
ADR = 0	1	1	1	1	1	0	0	0
ADR = 1	1	1	1	1	1	0	1	0

EC - externally configured by ADR pin

TABLE 2. Control Registers

	D7	D6	D5	D4	D3	D2	D1	D0
Mono Volume control	0	0	0	MD4	MD3	MD2	MD1	MD0
Left Volume control	0	1	LD5	LD4	LD3	LD2	LD1	LD0
Right Volume control	1	0	RD5	RD4	RD3	RD2	RD1	RD0
Mode control	1	1	CD5	CD4	CD3	CD2	CD1	CD0



# Application Information (Continued)

**TABLE 3. Mono Volume Control**

MD4	MD3	MD2	MD1	MD0	Gain (dB)
0	0	0	0	0	-34.5
0	0	0	0	1	-33.0
0	0	0	1	0	-31.5
0	0	0	1	1	-30.0
0	0	1	0	0	-28.5
0	0	1	0	1	-27.0
0	0	1	1	0	-25.5
0	0	1	1	1	-24.0
0	1	0	0	0	-22.5
0	1	0	0	1	-21.0
0	1	0	1	0	-19.5
0	1	0	1	1	-18.0
0	1	1	0	0	-16.5
0	1	1	0	1	-15.0
0	1	1	1	0	-13.5
0	1	1	1	1	-12.0
1	0	0	0	0	-10.5
1	0	0	0	1	-9.0
1	0	0	1	0	-7.5
1	0	0	1	1	-6.0
1	0	1	0	0	-4.5
1	0	1	0	1	-3.0
1	0	1	1	0	-1.5
1	0	1	1	1	0.0
1	1	0	0	0	1.5
1	1	0	0	1	3.0
1	1	0	1	0	4.5
1	1	0	1	1	6.0
1	1	1	0	0	7.5
1	1	1	0	1	9.0
1	1	1	1	0	10.5
1	1	1	1	1	12.0

# Application Information (Continued)

**TABLE 4. Stereo Volume Control**

LD4//RD4	LD3//RD3	LD2//RD2	LD1//RD1	LD0//RD0	Gain (dB)
0	0	0	0	0	-40.5
0	0	0	0	1	-39.0
0	0	0	1	0	-37.5
0	0	0	1	1	-36.0
0	0	1	0	0	-34.5
0	0	1	0	1	-33.0
0	0	1	1	0	-31.5
0	0	1	1	1	-30.0
0	1	0	0	0	-28.5
0	1	0	0	1	-27.0
0	1	0	1	0	-25.5
0	1	0	1	1	-24.0
0	1	1	0	0	-22.5
0	1	1	0	1	-21.0
0	1	1	1	0	-19.5
0	1	1	1	1	-18.0
1	0	0	0	0	-16.5
1	0	0	0	1	-15.0
1	0	0	1	0	-13.5
1	0	0	1	1	-12.0
1	0	1	0	0	-10.5
1	0	1	0	1	-9.0
1	0	1	1	0	-7.5
1	0	1	1	1	-6.0
1	1	0	0	0	-4.5
1	1	0	0	1	-3.0
1	1	0	1	0	-1.5
1	1	0	1	1	0.0
1	1	1	0	0	1.5
1	1	1	0	1	3.0
1	1	1	1	0	4.5
1	1	1	1	1	6.0

# Application Information (Continued)

**TABLE 5. Mixer and Output Mode Control**

Mode	CD3	CD2	CD1	CD0	Mono Line Out	Mono Earpiece		Loudspeaker L	Loudspeaker R	Headphone L	Headphone R
						(CD4 = 0)	(CD4 = 1)				
0	0	0	0	0	SD	SD	SD	SD	SD	SD	SD
1	0	0	0	1	MUTE	$(G_M \times M)$	$2(G_M \times M)$	SD	SD	MUTE	MUTE
2	0	0	1	0	MUTE	SD	SD	$2(G_M \times M)$	$2(G_M \times M)$	MUTE	MUTE
3	0	0	1	1	MUTE	SD	SD	$2(G_M \times M)$	$2(G_M \times M)$	$(G_M \times M)$	$(G_M \times M)$
4	0	1	0	0	MUTE	SD	SD	SD	SD	$(G_M \times M)$	$(G_M \times M)$
5	0	1	0	1	$(G_M \times M)$	SD	SD	SD	SD	MUTE	MUTE
6	0	1	1	0	MUTE	$(G_L \times L) + (G_R \times R)$	$2(G_L \times L) + 2(G_R \times R)$	SD	SD	MUTE	MUTE
7	0	1	1	1	MUTE	SD	SD	$2(G_L \times L)$	$2(G_R \times R)$	MUTE	MUTE
8	1	0	0	0	MUTE	SD	SD	$2(G_L \times L)$	$2(G_R \times R)$	$(G_L \times L)$	$(G_R \times R)$
9	1	0	0	1	MUTE	SD	SD	SD	SD	$(G_L \times L)$	$(G_R \times R)$
10	1	0	1	0	$(G_L \times L) + (G_R \times R)$	SD	SD	SD	SD	MUTE	MUTE
11	1	0	1	1	MUTE	$(G_M \times M) + (G_L \times L) + (G_R \times R)$	$2(G_M \times M) + 2(G_L \times L) + 2(G_R \times R)$	SD	SD	MUTE	MUTE
12	1	1	0	0	MUTE	SD	SD	$2(G_L \times L) + 2(G_M \times M)$	$2(G_R \times R) + 2(G_M \times M)$	MUTE	MUTE
13	1	1	0	1	MUTE	SD	SD	$2(G_L \times L) + 2(G_M \times M)$	$2(G_R \times R) + 2(G_M \times M)$	$(G_L \times L) + (G_M \times M)$	$(G_R \times R) + (G_M \times M)$
14	1	1	1	0	MUTE	SD	SD	SD	SD	$(G_L \times L) + (G_M \times M)$	$(G_R \times R) + (G_M \times M)$
15	1	1	1	1	$(G_M \times M) + (G_L \times L) + (G_R \times R)$	SD	SD	SD	SD	MUTE	MUTE

M -  $M_{IN}$  Input LevelL -  $L_{IN}$  Input LevelR -  $R_{IN}$  Input Level $G_M$  - Mono Volume Control Gain $G_L$  - Left Stereo Volume Control Gain $G_R$  - Right Stereo Volume Control Gain

SD - Shutdown

MUTE - Mute

**TABLE 6. National 3D Enhancement**

LD5	0	Loudspeaker National 3D Off
	1	Loudspeaker National 3D On
RD5	0	Headphone National 3D Off
	1	Headphone National 3D On

**TABLE 7. Wake-up Time Select**

CD5	0	Fast Wake-up Setting
	1	Slow Wake-up Setting

## Application Information (Continued)

**TABLE 8. Earpiece Amplifier Gain Select**

CD4	0	0dB Earpiece Output Stage Gain Setting
	1	6dB Earpiece Output Stage Gain Setting

### I<sup>2</sup>C COMPATIBLE INTERFACE

The LM4857 uses a serial bus, which conforms to the I<sup>2</sup>C protocol, to control the chip's functions with two wires: clock (SCL) and data (SDA). The clock line is uni-directional. The data line is bi-directional (open-collector). The maximum clock frequency specified by the I<sup>2</sup>C standard is 400kHz. In this discussion, the master is the controlling microcontroller and the slave is the LM4857.

The I<sup>2</sup>C address for the LM4857 is determined using the ADR pin. The LM4857's two possible I<sup>2</sup>C chip addresses are of the form 111110X<sub>1</sub>0 (binary), where X<sub>1</sub> = 0, if ADR is logic low; and X<sub>1</sub> = 1, if ADR is logic high. If the I<sup>2</sup>C interface is used to address a number of chips in a system, the LM4857's chip address can be changed to avoid any possible address conflicts.

The bus format for the I<sup>2</sup>C interface is shown in Figure 2. The bus format diagram is broken up into six major sections:

The "start" signal is generated by lowering the data signal while the clock signal is high. The start signal will alert all devices attached to the I<sup>2</sup>C bus to check the incoming address against their own address.

The 8-bit chip address is sent next, most significant bit first. The data is latched in on the rising edge of the clock. Each address bit must be stable while the clock level is high.

After the last bit of the address bit is sent, the master releases the data line high (through a pull-up resistor). Then the master sends an acknowledge clock pulse. If the LM4857 has received the address correctly, then it holds the data line low during the clock pulse. If the data line is not held low during the acknowledge clock pulse, then the master should abort the rest of the data transfer to the LM4857.

The 8 bits of data are sent next, most significant bit first. Each data bit should be valid while the clock level is stable high.

After the data byte is sent, the master must check for another acknowledge to see if the LM4857 received the data.

If the master has more data bytes to send to the LM4857, then the master can repeat the previous two steps until all data bytes have been sent.

The "stop" signal ends the transfer. To signal "stop", the data signal goes high while the clock signal is high. The data line should be held high when not in use.

### I<sup>2</sup>C INTERFACE POWER SUPPLY PIN (I<sup>2</sup>CV<sub>DD</sub>)

The LM4857's I<sup>2</sup>C interface is powered up through the I<sup>2</sup>CV<sub>DD</sub> pin. The LM4857's I<sup>2</sup>C interface operates at a voltage level set by the I<sup>2</sup>CV<sub>DD</sub> pin which can be set independent to that of the main power supply pin V<sub>DD</sub>. This is ideal whenever logic levels for the I<sup>2</sup>C interface are dictated by a microcontroller or microprocessor that is operating at a lower supply voltage than the main battery of a portable system.

### NATIONAL 3D ENHANCEMENT

The LM4857 features a 3D audio enhancement effect that widens the perceived soundstage from a stereo audio signal. The 3D audio enhancement improves the apparent stereo

channel separation whenever the left and right speakers are too close to one another, due to system size constraints or equipment limitations.

An external RC network, shown in Figure 1, is required to enable the 3D effect. There are separate RC networks for both the stereo loudspeaker outputs as well as the stereo headphone outputs, so the 3D effect can be set independently for each set of stereo outputs.

The amount of the 3D effect is set by the R<sub>3D</sub> resistor. Decreasing the value of R<sub>3D</sub> will increase the 3D effect. The C<sub>3D</sub> capacitor sets the low cutoff frequency of the 3D effect. Increasing the value of C<sub>3D</sub> will decrease the low cutoff frequency at which the 3D effect starts to occur, as shown by Equation 1.

$$f_{3D(-3dB)} = 1 / 2\pi(R_{3D})(C_{3D}) \quad (1)$$

Activating the 3D effect will cause an increase in gain by a multiplication factor of  $(1 + 9k\Omega/R_{3D})$ . Setting R<sub>3D</sub> to 9kΩ will result in a gain increase by a multiplication factor of  $(1 + 9k\Omega/9k\Omega) = 2$  or 6dB whenever the 3D effect is activated. The volume control can be programmed through the I<sup>2</sup>C compatible interface to compensate for the extra 6dB increase in gain. For example, if the stereo volume control is set at 0dB (11011 from Table 4) before the 3D effect is activated, the volume control should be programmed to -6dB (10111 from Table 4) immediately after the 3D effect has been activated. Setting R<sub>3D</sub> = 20kΩ and C<sub>3D</sub> = 0.22μF allows the LM4857 to produce a pronounced 3D effect with a minimal increase in output noise.

### EXPOSED-DAP MOUNTING CONSIDERATIONS

The LM4857's exposed-DAP (die attach paddle) package (SP) provides a low thermal resistance between the die and the PCB to which the part is mounted and soldered. This allows rapid heat transfer from the die to the surrounding PCB copper area heatsink, copper traces, ground plane, and finally, surrounding air. The result is a low voltage audio power amplifier that produces 1.6W dissipation in a 4Ω load at ≤ 1% THD+N and over 1.8W in a 3Ω load at 10% THD+N. This high power is achieved through careful consideration of necessary thermal design. Failing to optimize thermal design may compromise the LM4857's high power performance and activate unwanted, though necessary, thermal shutdown protection.

The SP package must have its DAP soldered to a copper pad on the PCB. The DAP's PCB copper pad is then, ideally, connected to a large plane of continuous unbroken copper. This plane forms a thermal mass, heat sink, and radiation area. Place the heat sink area on either outside plane in the case of a two-sided or multi-layer PCB. (The heat sink area can also be placed on an inner layer of a multi-layer board. The thermal resistance, however, will be higher.) Connect the DAP copper pad to the inner layer or backside copper heat sink area with 9 (3 X 3) (SP) vias. The via diameter should be 0.012in - 0.013in with a 1.27mm pitch. Ensure efficient thermal conductivity by plugging and tenting the vias with plating and solder mask, respectively.

## Application Information (Continued)

Best thermal performance is achieved with the largest practical copper heat sink area. If the heatsink and amplifier share the same PCB layer, a nominal  $2\text{in}^2$  area is necessary for 5V operation with a  $4\Omega$  load. Heatsink areas not placed on the same PCB layer as the LM4857 should be  $4\text{in}^2$  for the same supply voltage and load resistance. The last two area recommendations apply for  $25^\circ\text{C}$  ambient temperature. Increase the area to compensate for ambient temperatures above  $25^\circ\text{C}$ . In all circumstances and under all conditions, the junction temperature must be held below  $150^\circ\text{C}$  to prevent activating the LM4857's thermal shutdown protection. An example PCB layout for the exposed-DAP SP package is shown in the **Demonstration Board Layout** section. Further detailed and specific information concerning PCB layout and fabrication and mounting an SP (LLP) is found in National Semiconductor's AN1187.

### PCB LAYOUT AND SUPPLY REGULATION CONSIDERATIONS FOR DRIVING $3\Omega$ AND $4\Omega$ LOADS

Power dissipated by a load is a function of the voltage swing across the load and the load's impedance. As load impedance decreases, load dissipation becomes increasingly dependent on the interconnect (PCB trace and wire) resistance between the amplifier output pins and the load's connections. Residual trace resistance causes a voltage drop, which results in power dissipated in the trace and not in the load as desired. For example,  $0.1\Omega$  trace resistance reduces the output power dissipated by a  $4\Omega$  load from 1.6W to 1.5W. The problem of decreased load dissipation is exacerbated as load impedance decreases. Therefore, to maintain the highest load dissipation and widest output voltage swing, PCB traces that connect the output pins to a load must be as wide as possible.

Poor power supply regulation adversely affects maximum output power. A poorly regulated supply's output voltage decreases with increasing load current. Reduced supply voltage causes decreased headroom, output signal clipping, and reduced output power. Even with tightly regulated supplies, trace resistance creates the same effects as poor supply regulation. Therefore, making the power supply traces as wide as possible helps maintain full output voltage swing.

### BRIDGE CONFIGURATION EXPLANATION

The LM4857 consists of three sets of a bridged-tied amplifier pairs that drive the left loudspeaker (LLS), the right loudspeaker (RLS), and the mono earpiece (EP). For this discussion, only the LLS bridge-tied amplifier pair will be referred to. The LM4857 drives a load, such as a speaker, connected between outputs, LLS+ and LLS-. In the LLS amplifier block, the output of the amplifier that drives LLS- serves as the input to the unity gain inverting amplifier that drives LLS+.

This results in both amplifiers producing signals identical in magnitude, but  $180^\circ$  out of phase. Taking advantage of this phase difference, a load is placed between LLS- and LLS+ and driven differentially (commonly referred to as 'bridge mode'). This results in a differential or BTL gain of:

$$A_{VD} = 2(R_f / R_i) = 2 \quad (2)$$

Both the feedback resistor,  $R_f$ , and the input resistor,  $R_i$ , are internally set.

Bridge mode amplifiers are different from single-ended amplifiers that drive loads connected between a single amplifier's output and ground. For a given supply voltage, bridge mode has a distinct advantage over the single-ended configuration: its differential output doubles the voltage swing across the load. Theoretically, this produces four times the output power when compared to a single-ended amplifier under the same conditions. This increase in attainable output power assumes that the amplifier is not current limited and that the output signal is not clipped.

Another advantage of the differential bridge output is no net DC voltage across the load. This is accomplished by biasing LLS- and LLS+ outputs at half-supply. This eliminates the coupling capacitor that single supply, single-ended amplifiers require. Eliminating an output coupling capacitor in a typical single-ended configuration forces a single-supply amplifier's half-supply bias voltage across the load. This increases internal IC power dissipation and may permanently damage loads such as speakers.

### POWER DISSIPATION

Power dissipation is a major concern when designing a successful single-ended or bridged amplifier.

A direct consequence of the increased power delivered to the load by a bridge amplifier is higher internal power dissipation. The LM4857 has 3 sets of bridged-tied amplifier pairs driving LLS, RLS, and EP. The maximum internal power dissipation operating in the bridge mode is twice that of a single-ended amplifier. From Equation (3) and (4), assuming a 5V power supply and an  $8\Omega$  load, the maximum power dissipation for LLS and RLS is 634mW per channel. From equation (5), assuming a 5V power supply and a  $32\Omega$  load, the maximum power dissipation for EP is 158mW.

$$P_{\text{DMAX-LLS}} = 4(V_{\text{DD}})^2 / (2\pi^2 R_L): \text{ Bridged} \quad (3)$$

$$P_{\text{DMAX-RLS}} = 4(V_{\text{DD}})^2 / (2\pi^2 R_L): \text{ Bridged} \quad (4)$$

$$P_{\text{DMAX-EP}} = 4(V_{\text{DD}})^2 / (2\pi^2 R_L): \text{ Bridged} \quad (5)$$

The LM4857 also has 3 sets of single-ended amplifiers driving LHP, RHP, and LINEOUT. The maximum internal power dissipation for ROUT and LOUT is given by equation (6) and (7). From Equations (6) and (7), assuming a 5V power supply and a  $32\Omega$  load, the maximum power dissipation for LOUT and ROUT is 40mW per channel. From equation (8), assuming a 5V power supply and a  $5k\Omega$  load, the maximum power dissipation for LINEOUT is negligible.

$$P_{\text{DMAX-LHP}} = (V_{\text{DD}})^2 / (2\pi^2 R_L): \text{ Single-ended} \quad (6)$$

$$P_{\text{DMAX-RHP}} = (V_{\text{DD}})^2 / (2\pi^2 R_L): \text{ Single-ended} \quad (7)$$

$$P_{\text{DMAX-LINE}} = (V_{\text{DD}})^2 / (2\pi^2 R_L): \text{ Single-ended} \quad (8)$$

The maximum internal power dissipation of the LM4857 occurs during output modes 3, 8, and 13 when both loudspeaker and headphone amplifiers are simultaneously on; and is given by Equation (9).

$$P_{\text{DMAX-TOTAL}} = P_{\text{DMAX-LLS}} + P_{\text{DMAX-RLS}} + P_{\text{DMAX-LHP}} + P_{\text{DMAX-RHP}} \quad (9)$$

## Application Information (Continued)

The maximum power dissipation point given by Equation (9) must not exceed the power dissipation given by Equation (10):

$$P_{\text{DMAX}}' = (T_{\text{JMAX}} - T_{\text{A}}) / \theta_{\text{JA}} \quad (10)$$

The LM4857's  $T_{\text{JMAX}} = 150^{\circ}\text{C}$ . In the ITL package, the LM4857's  $\theta_{\text{JA}}$  is  $62^{\circ}\text{C/W}$ . At any given ambient temperature  $T_{\text{A}}$ , use Equation (10) to find the maximum internal power dissipation supported by the IC packaging. Rearranging Equation (10) and substituting  $P_{\text{DMAX-TOTAL}}$  for  $P_{\text{DMAX}}'$  results in Equation (11). This equation gives the maximum ambient temperature that still allows maximum stereo power dissipation without violating the LM4857's maximum junction temperature.

$$T_{\text{A}} = T_{\text{JMAX}} - P_{\text{DMAX-TOTAL}} \theta_{\text{JA}} \quad (11)$$

For a typical application with a 5V power supply, stereo  $8\Omega$  loudspeaker load, and the stereo  $32\Omega$  headphone load, the maximum ambient temperature that allows maximum stereo power dissipation without exceeding the maximum junction temperature is approximately  $66.4^{\circ}\text{C}$  for the ITL package.

$$T_{\text{JMAX}} = P_{\text{DMAX-TOTAL}} \theta_{\text{JA}} + T_{\text{A}} \quad (12)$$

Equation (12) gives the maximum junction temperature  $T_{\text{JMAX}}$ . If the result violates the LM4857's  $150^{\circ}\text{C}$ , reduce the maximum junction temperature by reducing the power supply voltage or increasing the load resistance. Further allowance should be made for increased ambient temperatures.

The above examples assume that a device is a surface mount part operating around the maximum power dissipation point. Since internal power dissipation is a function of output power, higher ambient temperatures are allowed as output power or duty cycle decreases. If the result of Equation (9) is greater than that of Equation (10), then decrease the supply voltage, increase the load impedance, or reduce the ambient temperature. If these measures are insufficient, a heat sink can be added to reduce  $\theta_{\text{JA}}$ . The heat sink can be created using additional copper area around the package, with connections to the ground pin(s), supply pin and amplifier output pins. External, solder attached SMT heatsinks such as the Thermalloy 7106D can also improve power dissipation. When adding a heat sink, the  $\theta_{\text{JA}}$  is the sum of  $\theta_{\text{JC}}$ ,  $\theta_{\text{CS}}$ , and  $\theta_{\text{SA}}$ . ( $\theta_{\text{JC}}$  is the junction-to-case thermal impedance,  $\theta_{\text{CS}}$  is the case-to-sink thermal impedance, and  $\theta_{\text{SA}}$  is the sink-to-ambient thermal impedance.) Refer to the Typical Performance Characteristics curves for power dissipation information at lower output power levels.

### POWER SUPPLY BYPASSING

As with any power amplifier, proper supply bypassing is critical for low noise performance and high power supply rejection. Applications that employ a 5V regulator typically use a  $10\mu\text{F}$  in parallel with a  $0.1\mu\text{F}$  filter capacitors to stabilize the regulator's output, reduce noise on the supply line, and improve the supply's transient response. However, their presence does not eliminate the need for a local  $1.0\mu\text{F}$  tantalum bypass capacitance connected between the

LM4857's supply pins and ground. Keep the length of leads and traces that connect capacitors between the LM4857's power supply pin and ground as short as possible.

### SELECTING EXTERNAL COMPONENTS

#### Input Capacitor Value Selection

Amplifying the lowest audio frequencies requires a high value input coupling capacitor ( $C_{\text{i}}$  in Figure 1). In many cases, however, the speakers used in portable systems, whether internal or external, have little ability to reproduce signals below 50Hz. Applications using speakers with this limited frequency response reap little improvement; by using a large input capacitor.

The internal input resistor ( $R_{\text{i}}$ ) and the input capacitor ( $C_{\text{i}}$ ) produce a high pass filter cutoff frequency that is found using Equation (13).

$$f_{\text{c}} = 1 / (2\pi R_{\text{i}} C_{\text{i}}) \quad (13)$$

As an example when using a speaker with a low frequency limit of 50Hz and  $R_{\text{i}} = 20\text{k}\Omega$ ,  $C_{\text{i}}$  using Equation (13) is  $0.19\mu\text{F}$ . The  $0.22\mu\text{F}$   $C_{\text{i}}$  shown in Figure 4 allows the LM4857 to drive high efficiency, full range speaker whose response extends below 40Hz.

#### Output Capacitor Value Selection

Amplifying the lowest audio frequencies also requires the use of a high value output coupling capacitor ( $C_{\text{O}}$  in Figure 1). A high value output capacitor can be expensive and may compromise space efficiency in portable design.

The speaker load ( $R_{\text{L}}$ ) and the output capacitor ( $C_{\text{O}}$ ) form a high pass filter with a low cutoff frequency determined using Equation (14).

$$f_{\text{c}} = 1 / (2\pi R_{\text{L}} C_{\text{O}}) \quad (14)$$

When using a typical headphone load of  $R_{\text{L}} = 32\Omega$  with a low frequency limit of 50Hz,  $C_{\text{O}}$  is  $99\mu\text{F}$ .

The  $100\mu\text{F}$   $C_{\text{O}}$  shown in Figure 4 allows the LM4857 to drive a headphone whose frequency response extends below 50Hz.

#### Bypass Capacitor Value Selection

Besides minimizing the input capacitor size, careful consideration should be paid to value of  $C_{\text{B}}$ , the capacitor connected to the BYPASS pin. Since  $C_{\text{B}}$  determines how fast the LM4857 settles to quiescent operation, its value is critical when minimizing turn-on pops. The slower the LM4857's outputs ramp to their quiescent DC voltage (nominally  $V_{\text{DD}}/2$ ), the smaller the turn-on pop. Choosing  $C_{\text{B}}$  equal to  $2.2\mu\text{F}$  along with a small value of  $C_{\text{i}}$  (in the range of  $0.1\mu\text{F}$  to  $0.39\mu\text{F}$ ), produces a click-less and pop-less shutdown function. As discussed above, choosing  $C_{\text{i}}$  no larger than necessary for the desired bandwidth helps minimize clicks and pops.  $C_{\text{B}}$ 's value should be in the range of 5 times to 10 times the value of  $C_{\text{i}}$ . This ensures that output transients are eliminated when the LM4857 transitions in and out of shutdown mode. Connecting a  $2.2\mu\text{F}$  capacitor,  $C_{\text{B}}$ , between the BYPASS pin and ground improves the internal bias voltage's stability and improves the amplifier's PSRR. The PSRR improvements increase as the bypass pin capacitor value increases. However, increasing the value of  $C_{\text{B}}$  will increase wake-up time. The selection of bypass capacitor value,  $C_{\text{B}}$ ,

### Application Information (Continued)

depends on desired PSRR requirements, click and pop performance, wake-up time, system cost, and size constraints.

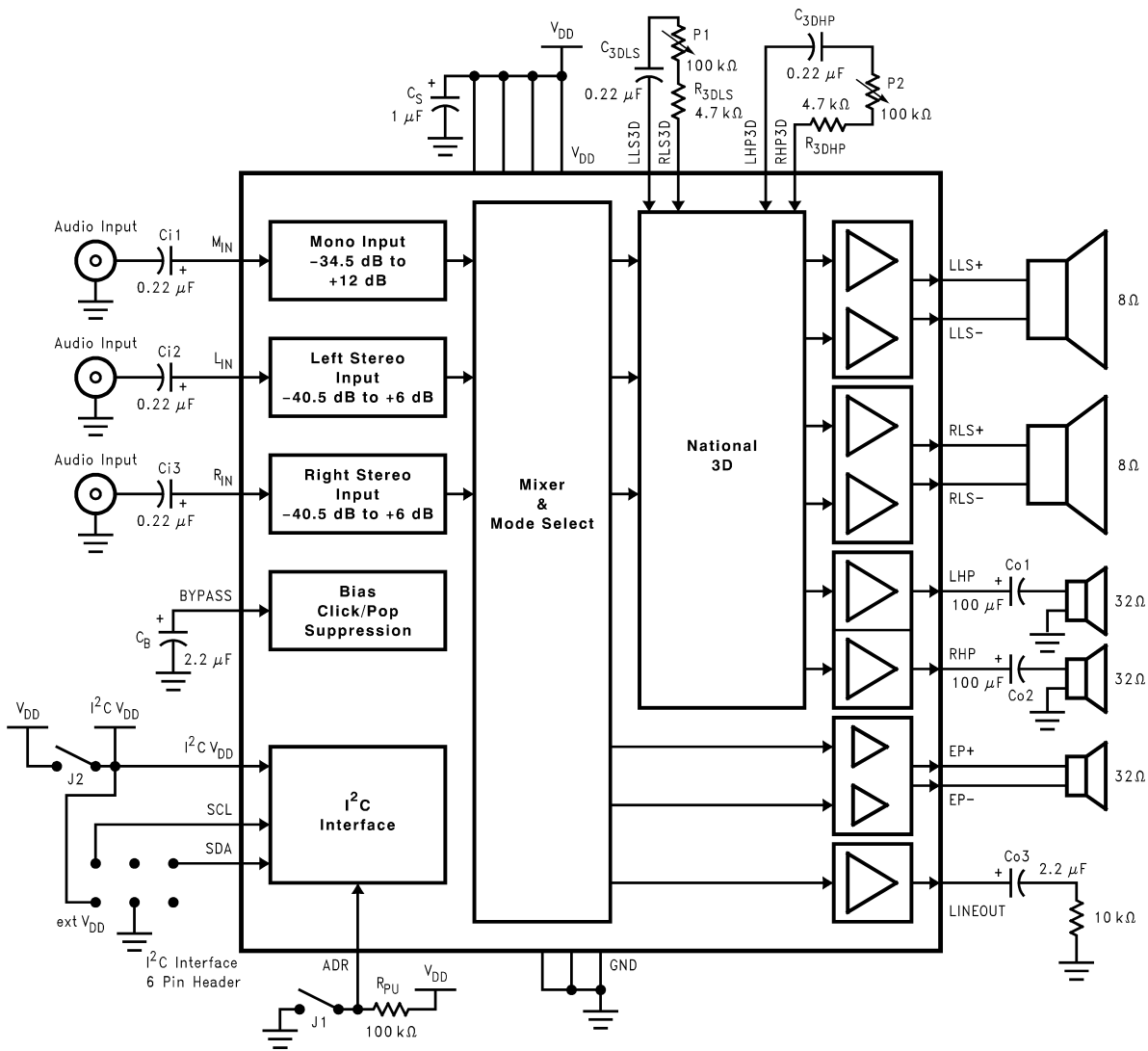

20079709

FIGURE 4. Reference Design Board Schematic



# Demonstration Board ITL PCB Layout

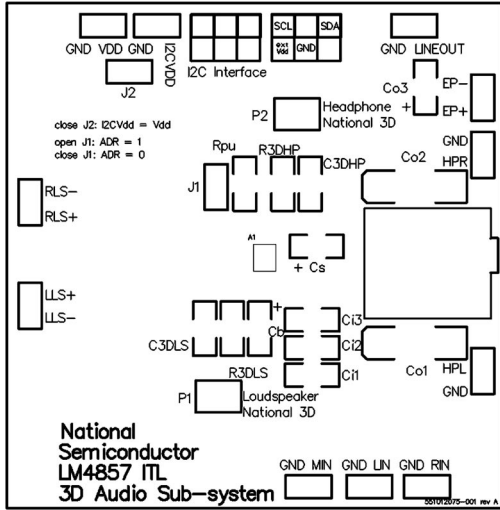

Recommended ITL PCB Layout:  
Top Silkscreen

20079707

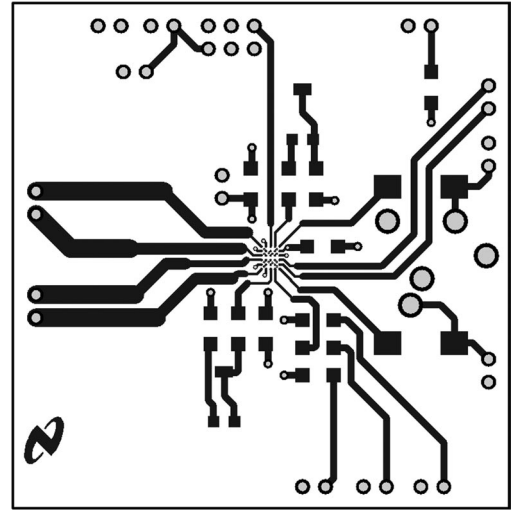

Recommended ITL PCB Layout:  
Top Layer

20079706

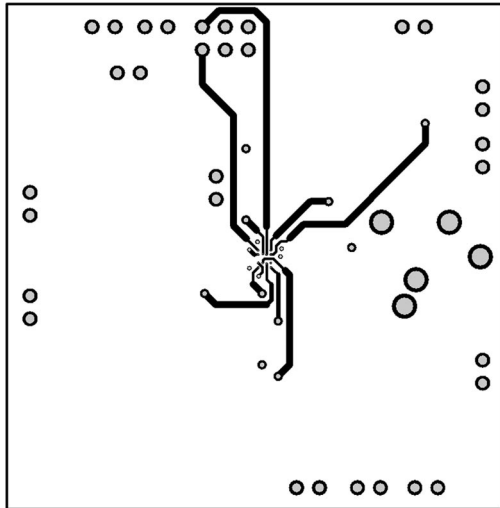

Recommended ITL PCB Layout:  
Inner Layer 1

20079704

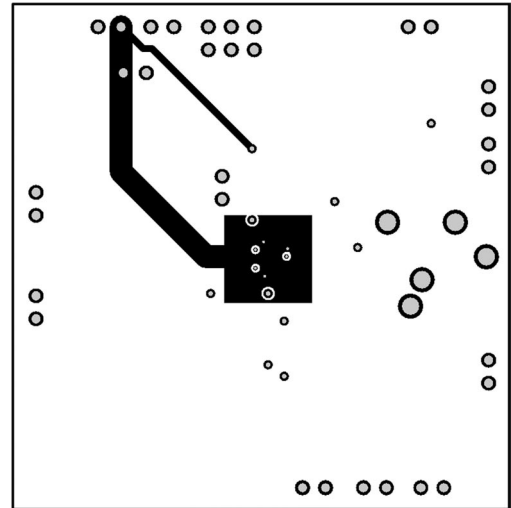

Recommended ITL PCB Layout:  
Inner Layer 2

20079705



# Demonstration Board ITL PCB Layout (Continued)

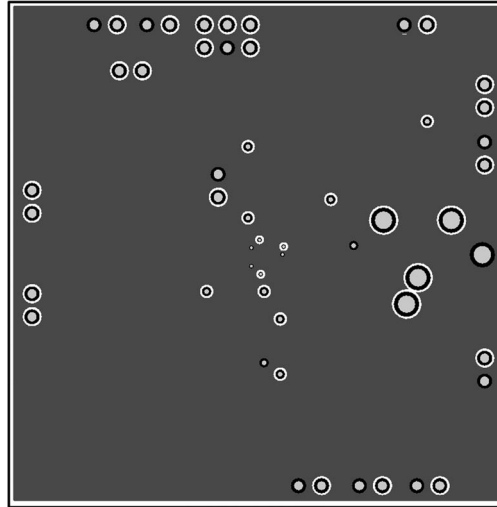

20079703

**Recommended ITL PCB Layout:  
Bottom Layer**

# Demonstration Board SP PCB Layout

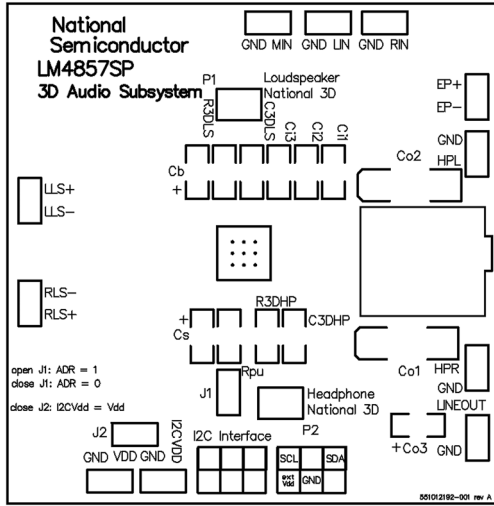

20079719

**Recommended SP PCB Layout:  
Top Over Layer**

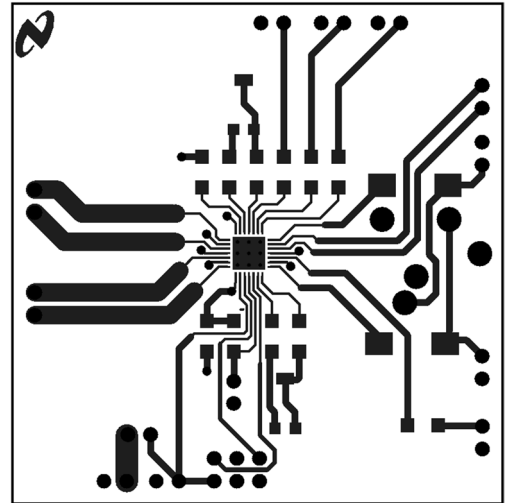

20079718

**Recommended SP PCB Layout:  
Top Layer**

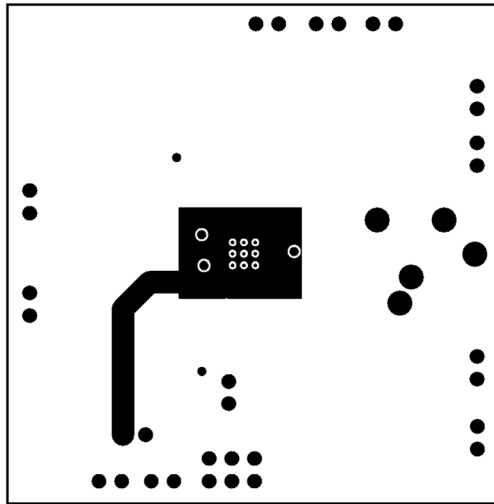

20079717

**Recommended SP PCB Layout:  
Mid Layer**

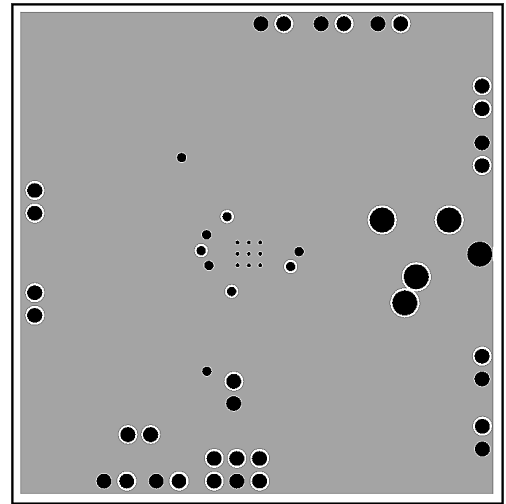

20079716

**Recommended SP PCB Layout:  
Bottom Layer**

## Revision History

Rev	Date	Description
1.1	6/03/05	Changed the numerical value of 20 into 9 in the last paragraph of "NATIONAL 3D ENHANCEMENT (per Alvin F.), then re-released D/S to the WEB. (MC)
1.2	6/07/05	Deleted all references on GR pkg (GR pkgs on HOLD) per Kevin Chen, then re-WEBd the D/S. (MC)

**Physical Dimensions** inches (millimeters) unless otherwise noted

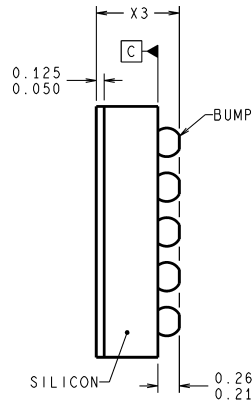
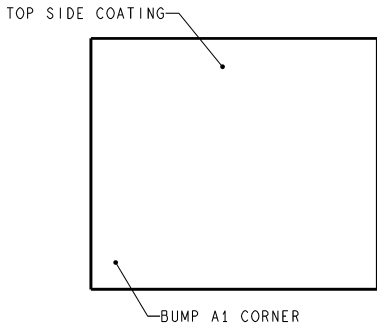
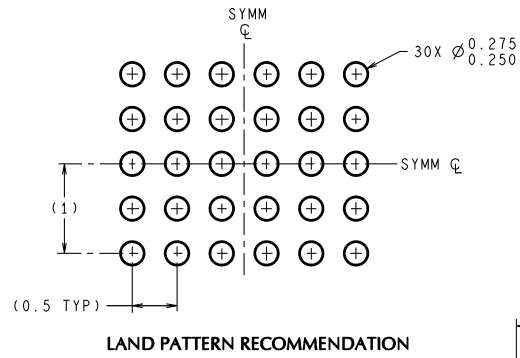

DIMENSIONS ARE IN MILLIMETERS  
DIMENSIONS IN ( ) FOR REFERENCE ONLY

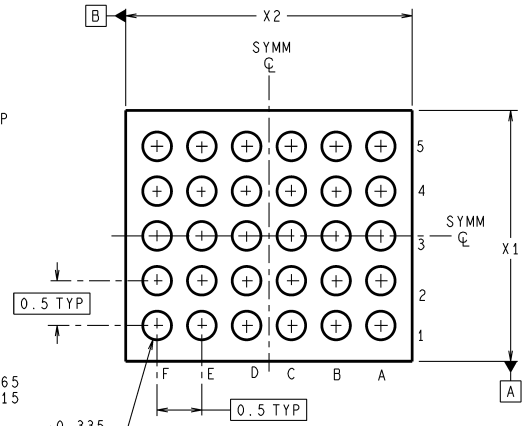

$\phi$ 0.005	C	A	B
--------------	---	---	---

TLA30XXX (Rev C)

**30-Bump micro SMD**  
**Order Number LM4857ITL**  
**NS Package Number TLA30CZA**  
 $X_1 = 2.543 \pm 0.03$   $X_2 = 2.949 \pm 0.03$   $X_3 = 0.6 \pm 0.075$

**Physical Dimensions** inches (millimeters) unless otherwise noted (Continued)

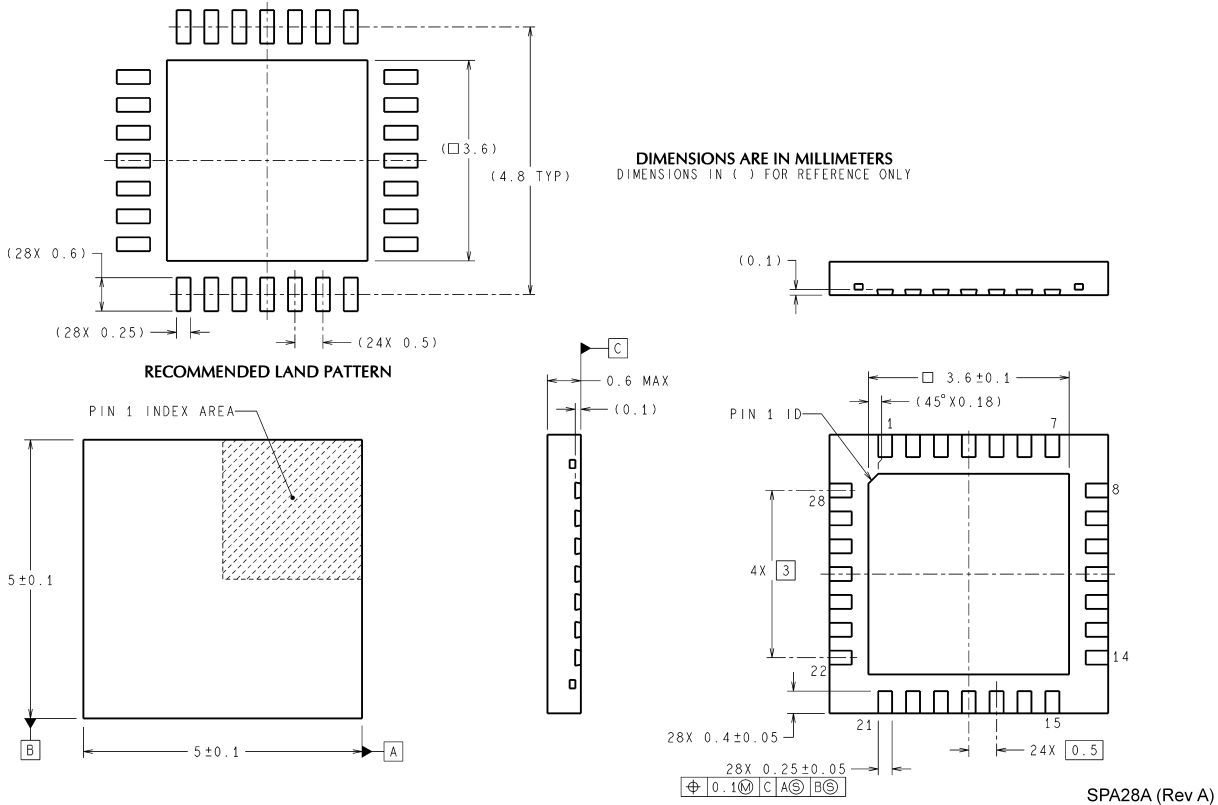

**28 — Lead SP Package**  
**Order Number LM4857SP**  
**NS Package Number SPA28A**

National does not assume any responsibility for use of any circuitry described, no circuit patent licenses are implied and National reserves the right at any time without notice to change said circuitry and specifications.  
 For the most current product information visit us at [www.national.com](http://www.national.com).

**LIFE SUPPORT POLICY**

NATIONAL'S PRODUCTS ARE NOT AUTHORIZED FOR USE AS CRITICAL COMPONENTS IN LIFE SUPPORT DEVICES OR SYSTEMS WITHOUT THE EXPRESS WRITTEN APPROVAL OF THE PRESIDENT AND GENERAL COUNSEL OF NATIONAL SEMICONDUCTOR CORPORATION. As used herein:

1. Life support devices or systems are devices or systems which, (a) are intended for surgical implant into the body, or (b) support or sustain life, and whose failure to perform when properly used in accordance with instructions for use provided in the labeling, can be reasonably expected to result in a significant injury to the user.
2. A critical component is any component of a life support device or system whose failure to perform can be reasonably expected to cause the failure of the life support device or system, or to affect its safety or effectiveness.

**BANNED SUBSTANCE COMPLIANCE**

National Semiconductor manufactures products and uses packing materials that meet the provisions of the Customer Products Stewardship Specification (CSP-9-111C2) and the Banned Substances and Materials of Interest Specification (CSP-9-111S2) and contain no "Banned Substances" as defined in CSP-9-111S2.

Leadfree products are RoHS compliant.



**National Semiconductor**  
**Americas Customer Support Center**  
 Email: [new.feedback@nsc.com](mailto:new.feedback@nsc.com)  
 Tel: 1-800-272-9959

**National Semiconductor**  
**Europe Customer Support Center**  
 Fax: +49 (0) 180-530 85 86  
 Email: [europe.support@nsc.com](mailto:europe.support@nsc.com)  
 Deutsch Tel: +49 (0) 69 9508 6208  
 English Tel: +44 (0) 870 24 0 2171  
 Français Tel: +33 (0) 1 41 91 8790

**National Semiconductor**  
**Asia Pacific Customer Support Center**  
 Email: [ap.support@nsc.com](mailto:ap.support@nsc.com)

**National Semiconductor**  
**Japan Customer Support Center**  
 Fax: 81-3-5639-7507  
 Email: [jpn.feedback@nsc.com](mailto:jpn.feedback@nsc.com)  
 Tel: 81-3-5639-7560

[www.national.com](http://www.national.com)