

Fast CMOS 16-Bit Buffer/Line Drivers

Features

Common Features

- High-speed, low-power devices with high-current drive
 $V_{CC}=5V\pm 10\%$
- Hysteresis on all inputs
- Device models available upon request

PI74FCT16244T Features

- High output drive: $I_{OH} = -32mA$; $I_{OL} = 64mA$
- Power off disable outputs permit "live insertion"
- Typical V_{OLP} (Output Ground Bounce)
 $< 1.0V$ at $V_{CC} = 5V$, $T_A = 25^\circ C$

PI74FCT162244T Features

- Balanced output drivers: $\pm 24mA$
- Reduced system switching noise
- Typical V_{OLP} (Output Ground Bounce)
 $< 0.6V$ at $V_{CC} = 5V$, $T_A = 25^\circ C$
- Packaging (Pb-free & Green available):
 - 48-pin 240-mil wide plastic TSSOP (A)
 - 48-pin 300-mil wide plastic SSOP (V)
 - 48-pin 173-mil wide plastic TVSOP (K)

Description

Pericom Semiconductor's PI74FCT16244T and PI74FCT162244T are non-inverting 16-bit buffer/line drivers designed for applications driving high capacitance loads and low impedance backplanes. These high-speed, low power devices offer bus/backplane interface capability and a flow-through organization for ease of board layout. These devices are designed with three-state controls to operate in a Quad-Nibble, Dual-Byte, or a single 16-bit word mode.

The PI74FCT16244T output buffers are designed with a Power-Off disable allowing "live insertion" of boards when used as backplane drivers.

The PI74FCT162244T has $\pm 24mA$ balanced output drivers. It is designed with current limiting resistors at its outputs to control the output edge rate resulting in lower ground bounce and undershoot. This eliminates the need for external terminating resistors for most interface applications.

Block Diagram

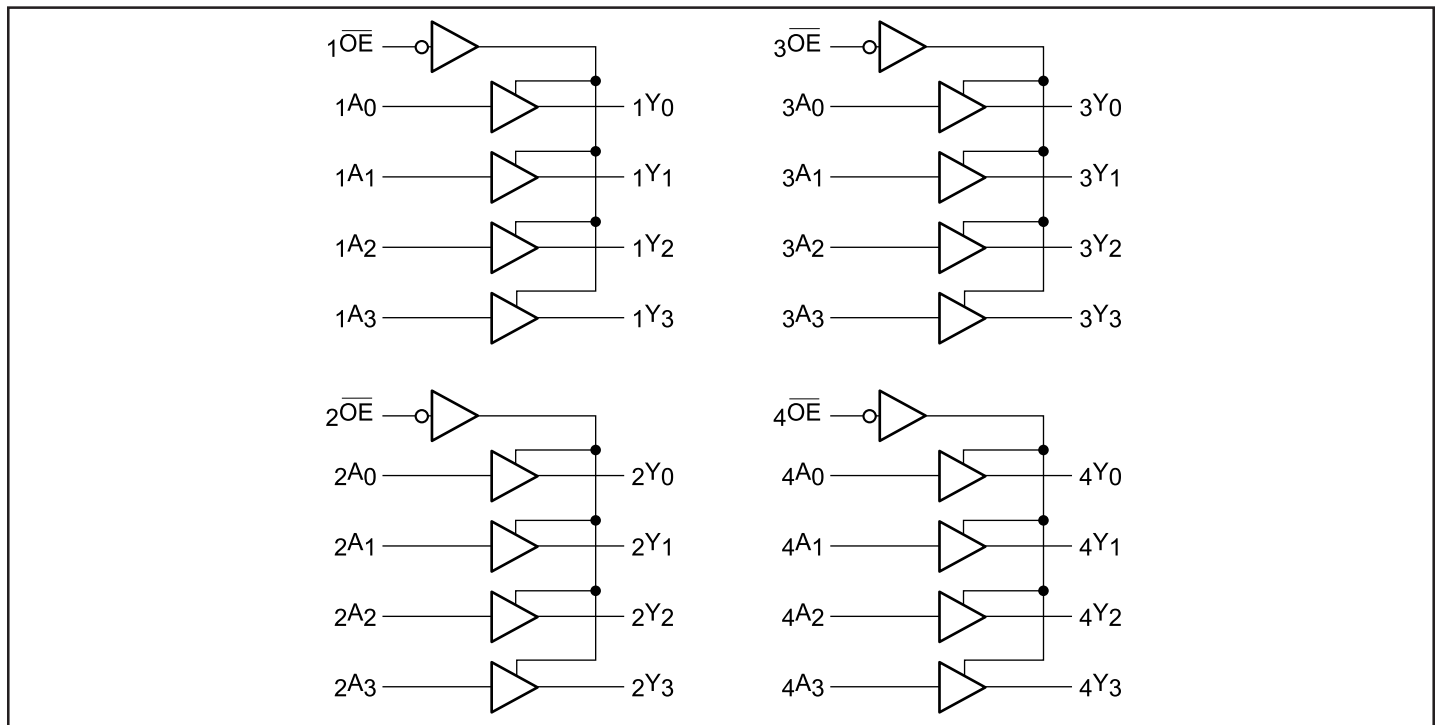

Product Pin Description

Pin Name	Description
\overline{xOE}	3-State Output Enable Inputs (Active LOW)
xAx	Inputs ⁽¹⁾
xYx	3-State Outputs
GND	Ground
Vcc	Power

Truth Table

Inputs ⁽¹⁾		Outputs ⁽¹⁾
\overline{xOE}	xAx	xYx
L	L	L
L	H	H
H	X	Z

Note:

- H = High Voltage Level, X = Don't Care,
L = Low Voltage Level, Z = High Impedance

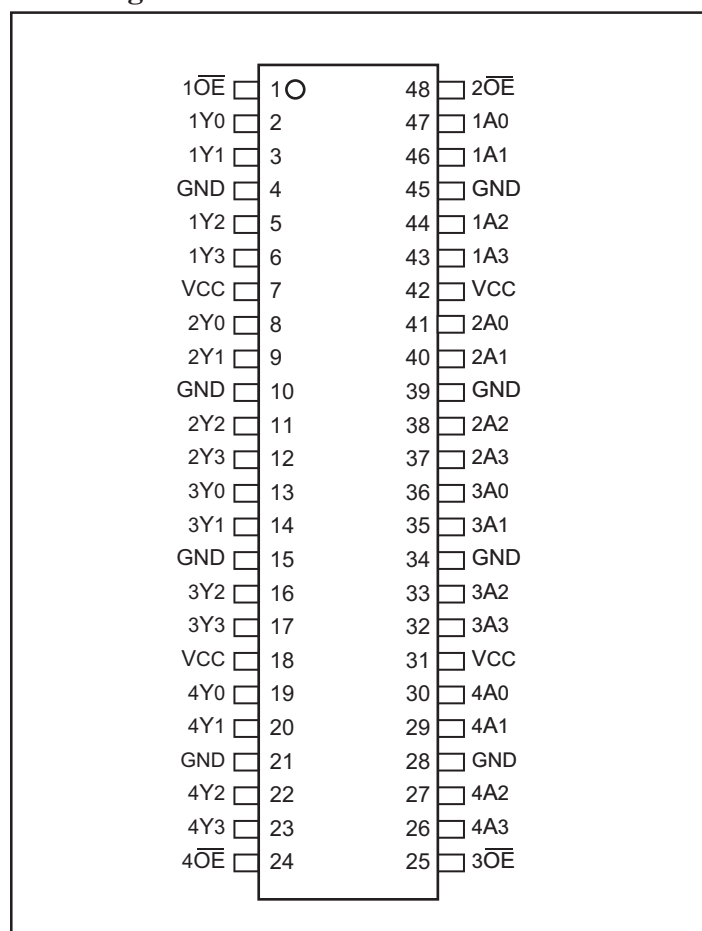
Pin Configuration

Maximum Ratings

(Above which the useful life may be impaired. For user guidelines, not tested.)

Storage Temperature	-65°C to +150°C
Ambient Temperature with Power Applied	-40°C to +85°C
Supply Voltage to Ground Potential (Inputs & Vcc Only) ...	-0.5V to +7.0V
Supply Voltage to Ground Potential (Outputs & D/O Only)	-0.5V to +7.0V
DC Input Voltage	-0.5V to +7.0V
DC Output Current	120mA
Power Dissipation	1.0W

Note:

Stresses greater than those listed under MAXIMUM RATINGS may cause permanent damage to the device. This is a stress rating only and functional operation of the device at these or any other conditions above those indicated in the operational sections of this specification is not implied. Exposure to absolute maximum rating conditions for extended periods may affect reliability.

DC Electrical Characteristics (Over the Operating Range, T_A = -40°C to +85°C, V_{CC} = 5.0V ±10%)

Parameters	Description	Test Conditions ⁽¹⁾		Min.	Typ. ⁽²⁾	Max.	Units
V _{IH}	Input HIGH Voltage	Guaranteed Logic HIGH Level		2.0			V
V _{IL}	Input LOW Voltage	Guaranteed Logic LOW Level				0.8	V
I _{IH}	Input HIGH Current	Standard Input, V _{CC} = Max.	V _{IN} = V _{CC}			1	μA
I _{IH}	Input HIGH Current	Standard I/O, V _{CC} = Max.	V _{IN} = V _{CC}			1	μA
I _{IL}	Input LOW Current	Standard Input, V _{CC} = Min.	V _{IN} = GND			-1	μA
I _{IL}	Input LOW Current	Standard I/O, V _{CC} = Min.	V _{IN} = GND			-1	μA
I _{OZH}	High Impedance	V _{CC} = Max.	V _{OUT} = 2.7V			1	μA
I _{OZL}	Output Current	V _{CC} = Max.	V _{OUT} = 0.5V			-1	μA
V _{IK}	Clamp Diode Voltage	V _{CC} = Min., I _{IN} = -18mA			-0.7	-1.2	V
I _{OS}	Short Circuit Current	V _{CC} = Max. ⁽³⁾ , V _{OUT} = GND		-80	-140	-320	mA
I _O	Output Drive Current	V _{CC} = Max. ⁽³⁾ , V _{OUT} = 2.5V		-50		-180	mA
V _H	Input Hysteresis				100		mV

Notes:

1. For Max. or Min. conditions, use appropriate value specified under Electrical Characteristics for the applicable device type.
2. Typical values are at V_{CC} = 5.0V, +25°C ambient and maximum loading.
3. Not more than one output should be shorted at one time. Duration of the test should not exceed one second.

PI74FCT16244T Output Drive Characteristics (Over the Operating Range)

Parameters	Description	Test Conditions ⁽¹⁾		Min.	Typ. ⁽²⁾	Max.	Units
VOH	Output HIGH Voltage	VCC = Min., VIN = VIH or VIL	IOH = -3.0mA	2.5	3.5		V
			IOH = -15.0mA	2.4	3.5		
			IOH = -32.0mA	2.0	3.0		
VOL	Output LOW Voltage	VCC = Min., VIN = VIH or VIL	IOL = 64mA		0.2	0.55	V
IOFF	Power Down Disable	VCC = 0V, VIN or VOUT = -4.5V				±100	μA

Notes:

1. For Max. or Min. conditions, use appropriate value specified under Electrical Characteristics for the applicable device type.
2. Typical values are at VCC = 5.0V, +25°C ambient and maximum loading.

PI74FCT162244T Output Drive Characteristics (Over the Operating Range)

Parameters	Description	Test Conditions ⁽¹⁾		Min.	Typ. ⁽²⁾	Max.	Units
VOH	Output HIGH Voltage	VCC = Min., VIN = VIH or VIL	IOH = -24.0mA	2.4	3.3		V
VOL	Output LOW Voltage	VCC = Min., VIN = VIH or VIL	IOL = 24mA		0.3	0.55	V
IODL	Output LOW Current	VCC = 5V, VIN = VIH OR VIL, VOUT = 1.5V ⁽³⁾		60	115	150	mA
IODH	Output HIGH Current	VCC = 5V, VIN = VIH OR VIL, VOUT = 1.5V ⁽³⁾		-60	-115	-160	mA

Notes:

1. For Max. or Min. conditions, use appropriate value specified under Electrical Characteristics for the applicable device type.
2. Typical values are at VCC = 5.0V, +25°C ambient and maximum loading.
3. Not more than one output should be shorted at one time. Duration of the test should not exceed one second.

Capacitance (TA = 25°C, f = 1 MHz)

Parameters ⁽¹⁾	Description	Test Conditions	Typ	Max.	Units
CIN	Input Capacitance	VIN = 0V	4.5	7.5	pF
COUT	Output Capacitance	VOUT = 0V	5.5	8	pF

Notes:

1. This parameter is determined by device characterization but is not production tested.

Power Supply Characteristics

Parameters	Description	Test Conditions ⁽¹⁾		Min.	Typ ⁽²⁾	Max.	Units
I _{CC}	Quiescent Power Supply Current	V _{CC} = Max.	V _{IN} = GND or V _{CC}		0.1	500	μA
ΔI _{CC}	Supply Current per Input @ TTL HIGH	V _{CC} = Max.	V _{IN} = 3.4V ⁽³⁾		0.5	1.5	mA
I _{CCD}	Supply Current per Input per MHz ⁽⁴⁾	V _{CC} = Max., Outputs Open x $\overline{\text{OE}}$ = GND One Bit Toggling 50% Duty Cycle	V _{IN} = V _{CC} V _{IN} = GND		60	100	μA/ MHz
I _C	Total Power Supply Current ⁽⁶⁾	V _{CC} = Max., Outputs Open f _i = 10 MHz 50% Duty Cycle x $\overline{\text{OE}}$ = GND One Bit Toggling	V _{IN} = V _{CC} V _{IN} = GND		0.6	1.5 ⁽⁵⁾	mA
			V _{IN} = 3.4V V _{IN} = GND		0.9	2.3 ⁽⁵⁾	
		V _{CC} = Max., Outputs Open f _i = 2.5 MHz 50% Duty Cycle x $\overline{\text{OE}}$ = GND 16 Bits Toggling	V _{IN} = V _{CC} V _{IN} = GND		2.4	4.5 ⁽⁵⁾	
			V _{IN} = 3.4V V _{IN} = GND		6.4	16.5 ⁽⁵⁾	

Notes:

- For Max. or Min. conditions, use appropriate value specified under Electrical Characteristics for the applicable device.
- Typical values are at V_{CC} = 5.0V, +25°C ambient.
- Per TTL driven input (V_{IN} = 3.4V); all other inputs at V_{CC} or GND.
- This parameter is not directly testable, but is derived for use in Total Power Supply Calculations.
- Values for these conditions are examples of the I_{CC} formula. These limits are guaranteed but not tested.

6. I_C = I_{QUIESCENT} + I_{INPUTS} + I_{DYNAMIC}

$$I_C = I_{CC} + \Delta I_{CC} D_H N_T + I_{CCD} (f_{CP}/2 + f_i N_i)$$

I_{CC} = Quiescent Current

ΔI_{CC} = Power Supply Current for a TTL High Input (V_{IN} = 3.4V)

D_H = Duty Cycle for TTL Inputs High

N_T = Number of TTL Inputs at D_H

I_{CCD} = Dynamic Current Caused by an Input Transition Pair (HLH or LHL)

f_{CP} = Clock Frequency for Register Devices (Zero for Non-Register Devices)

f_i = Input Frequency

N_i = Number of Inputs at f_i

All currents are in milliamps and all frequencies are in megahertz.

PI74FCT16244T Switching Characteristics over Operating Range

Parameters	Description	Conditions	16244T		16244AT		16244CT		16244ET		Units
			Com.		Com.		Com.		Com.		
			Min	Max	Min	Max	Min	Max	Min	Max	
tPLH tPHL	Propagation Delay ⁽¹⁾ xAX to xYX	CL = 50 pF RL = 500Ω	1.5	6.5	1.5	4.8	1.5	4.1	1.5	3.2	ns
tpZH tpZL	Output Enable Time xOE to xYX		1.5	8.0	1.5	6.2	1.5	5.8	1.5	4.4	ns
tPHZ tPLZ tsk(o)	Output Disable Time ⁽²⁾ xOE to xYX Output Skew ⁽³⁾		1.5	7.0	1.5	5.6	1.5	5.2	1.5	4.3	ns
				0.5		0.5		0.5		0.5	ns

Notes:

1. Minimum limits are guaranteed but not tested on Propagation Delays.
2. This parameter is guaranteed but not production tested.
3. Skew between any two outputs, of the same package, switching in the same direction. This parameter is guaranteed by design.

PI74FCT162244T Switching Characteristics over Operating Range

Parameters	Description	Conditions	162244T		162244AT		162244CT		162244ET		Units
			Com.		Com.		Com.		Com.		
			Min	Max	Min	Max	Min	Max	Min	Max	
tPLH tPHL	Propagation Delay ⁽¹⁾ xAX to xYX	CL = 50 pF RL = 500Ω	1.5	6.5	1.5	4.8	1.5	4.1	1.5	3.2	ns
tpZH tpZL	Output Enable Time xOE to xYX		1.5	8.0	1.5	6.2	1.5	5.8	1.5	4.4	ns
tPHZ tPLZ tsk(o)	Output Disable Time ⁽²⁾ xOE to xYX Output Skew ⁽³⁾		1.5	7.0	1.5	5.6	1.5	5.2	1.5	4.0	ns
				0.5		0.5		0.5		0.5	ns

Notes:

1. Minimum limits are guaranteed but not tested on Propagation Delays.
2. This parameter is guaranteed but not production tested.
3. Skew between any two outputs, of the same package, switching in the same direction. This parameter is guaranteed by design.

Packaging Mechanical: 48-Pin, 240 mil wide Plastic TSSOP (A)

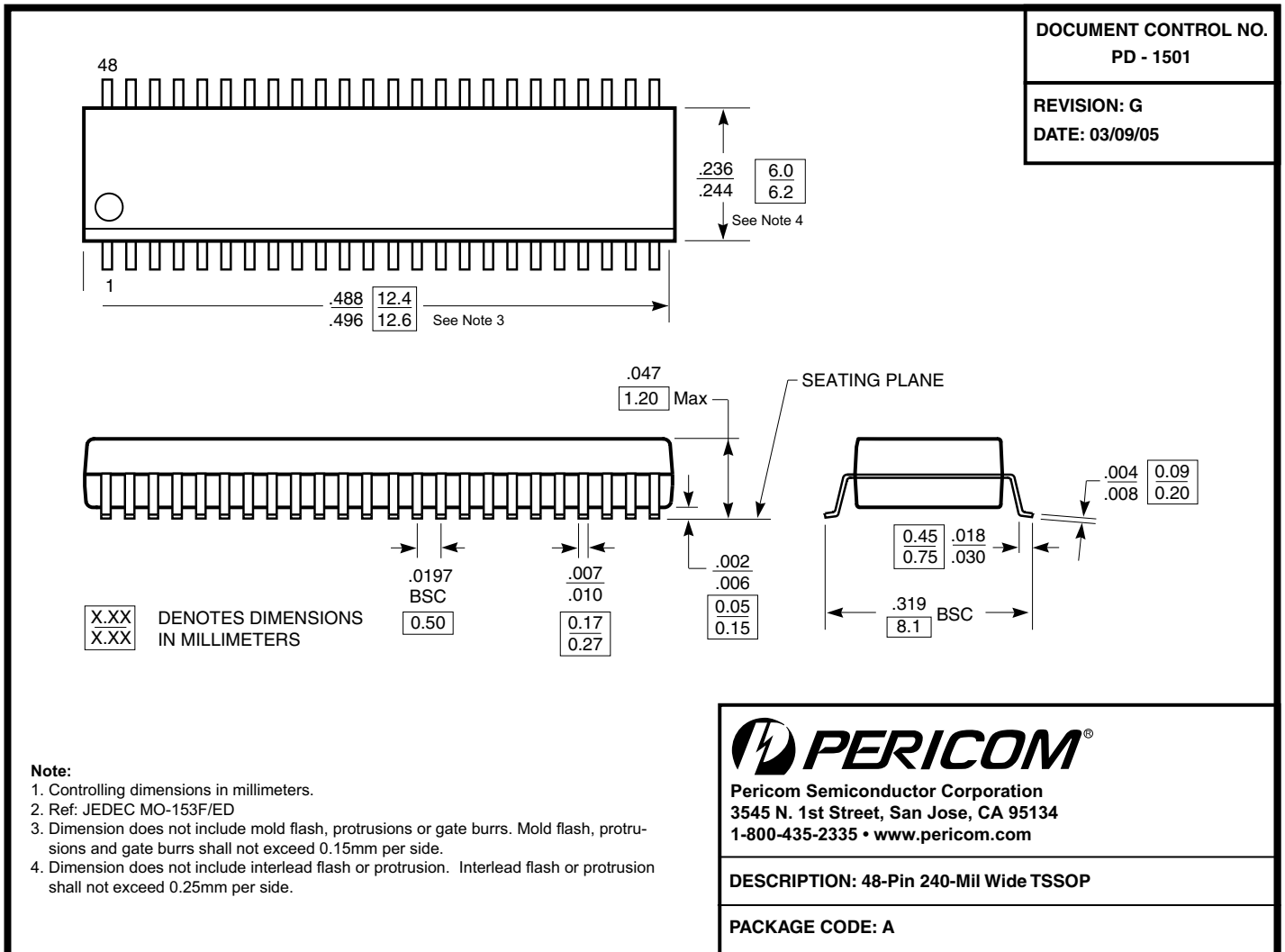

Packaging Mechanical: 48-pin 300 mil wide plastic SSOP (V)

DOCUMENT CONTROL NO.
PD - 1401

REVISION: E
DATE: 03/09/05

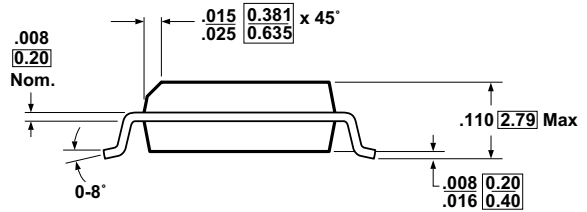
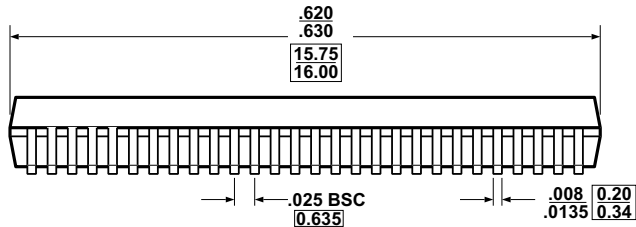
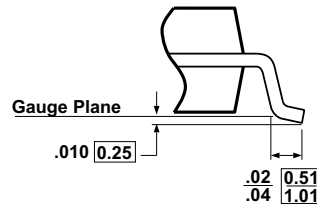
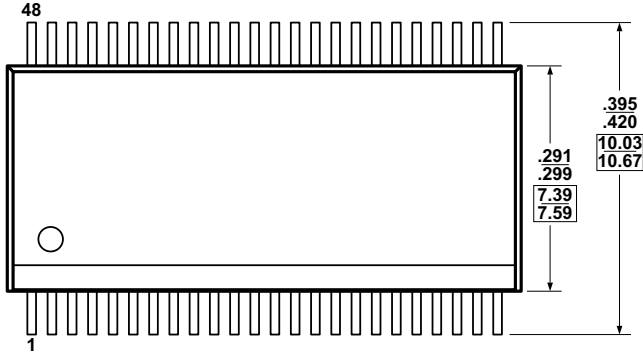

X.XX DENOTES DIMENSIONS
IN MILLIMETERS

Notes:

- 1) Controlling dimensions in inches.
- 2) Ref: JEDEC MO-118B/AA



Pericom Semiconductor Corporation
3545 N. 1st Street, San Jose, CA 95134
1-800-435-2335 • www.pericom.com

DESCRIPTION: 48-Pin, 300-Mil Wide, SSOP

PACKAGE CODE: V

PI74FCT162244T Ordering Information

Ordering Code	Package Code	Speed Grade	Package Type
PI74FCT162244TAE	A	Blank	Pb-free & Green, 48-pin 240-mil wide TSSOP
PI74FCT162244CTV	V	C	48-pin 300-mil wide SSOP
PI74FCT162244CTA	A	C	48-pin 240-mil wide TSSOP
PI74FCT162244ATV	V	A	48-pin 300-mil wide SSOP

Notes:

- Thermal characteristics can be found on the company web site at www.pericom.com/packaging/
- E = Pb-free & Green
- Adding an X suffix = Tape/Reel

Part Marking Information

Pericom's standard product mark follows our standard part number ordering information, except for those products with a speed letter code. For marking purposes, the speed letter code mark is placed after the package code letter, rather than after the device number as it is ordered.

Although all products are marked immediately after assembly to assure material traceability, Pericom does not usually mark the speed code at that time. After electrical test screening and speed binning have been completed, we then perform an "add mark" operation which places the speed code letter at the end of the complete part number.

Please refer to the example shown below:

- Part Number as ordered: PI74FCT245ATQ
- Example of Part Number as marked:

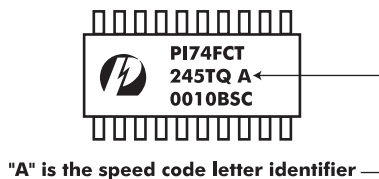

Notes:

- 1) 8-pin DIP, 8-pin SOIC, 8-pin TSSOP, 14-pin SOIC, 16-pin QSOP, SC70, MSOP, and SOT23 packages are not marked with the Pericom logo due to space limitations on the package.