

## 74VHC244

### Octal Buffer/Line Driver with 3-STATE Outputs

#### General Description

The VHC244 is an advanced high speed CMOS octal bus buffer fabricated with silicon gate CMOS technology. It achieves high speed operation similar to equivalent Bipolar Schottky TTL while maintaining the CMOS low power dissipation. The VHC244 is a non-inverting 3-STATE buffer having two active-LOW output enables. These devices are designed to be used as 3-STATE memory address drivers, clock drivers, and bus oriented transmitter/receivers.

An input protection circuit ensures that 0V to 7V can be applied to the input pins without regard to the supply voltage. This device can be used to interface 5V to 3V systems and two supply systems such as battery back up. This circuit prevents device destruction due to mismatched supply and input voltages.

#### Features

- High Speed:  $t_{PD} = 3.9ns$  (typ) at  $V_{CC} = 5V$
- High noise immunity:  $V_{NIH} = V_{NIL} = 28\% V_{CC}$  (min)
- Power down protection is provided on all inputs
- Low noise:  $V_{OLP} = 0.6V$  (typ)
- Low power dissipation:  $I_{CC} = 4 \mu A$  (max) @  $T_A = 25^\circ C$
- Pin and function compatible with 74HC244

#### Ordering Code:

Order Number	Package Number	Package Description
74VHC244M	M20B	20-Lead Small Outline Integrated Circuit (SOIC), JEDEC MS-013, 0.300" Wide
74VHC244SJ	M20D	Pb-Free 20-Lead Small Outline Package (SOP), EIAJ TYPE II, 5.3mm Wide
74VHC244MTC	MTC20	20-Lead Thin Shrink Small Outline Package (TSSOP), JEDEC MO-153, 4.4mm Wide
74VHC244N	N20A	20-Lead Plastic Dual-In-Line Package (PDIP), JEDEC MS-001, 0.300" Wide

Surface mount packages are also available on Tape and Reel. Specify by appending the suffix letter "X" to the ordering code.  
Pb-Free package per JEDEC J-STD-020B.

#### Logic Symbol

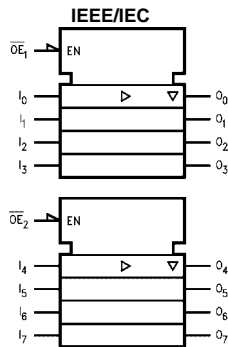

#### Connection Diagram

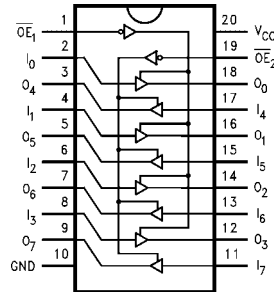

## Pin Descriptions

Pin Names	Description
$\overline{OE}_1, \overline{OE}_2$	3-STATE Output Enable Inputs
$I_0-I_7$	Inputs
$O_0-O_7$	3-STATE Outputs

## Truth Tables

Inputs		Outputs
$\overline{OE}_1$	$I_n$	(Pins 12, 14, 16, 18)
L	L	L
L	H	H
H	X	Z

Inputs		Outputs
$\overline{OE}_2$	$I_n$	(Pins 3, 5, 7, 9)
L	L	L
L	H	H
H	X	Z

H = HIGH Voltage Level  
 L = LOW Voltage Level  
 I = Immaterial  
 Z = High Impedance

**Absolute Maximum Ratings**(Note 1)

Supply Voltage ( $V_{CC}$ )	-0.5V to +7.0V
DC Input Voltage ( $V_{IN}$ )	-0.5V to +7.0V
DC Output Voltage ( $V_{OUT}$ )	-0.5V to $V_{CC} + 0.5V$
Input Diode Current ( $I_{IK}$ )	-20 mA
Output Diode Current ( $I_{OK}$ )	$\pm 20$ mA
DC Output Current ( $I_{OUT}$ )	$\pm 25$ mA
DC $V_{CC}$ /GND Current ( $I_{CC}$ )	$\pm 75$ mA
Storage Temperature ( $T_{STG}$ )	-65°C to +150°C
Lead Temperature ( $T_L$ ) (Soldering, 10 seconds)	260°C

**Recommended Operating Conditions** (Note 2)

Supply Voltage ( $V_{CC}$ )	2.0V to 5.5V
Input Voltage ( $V_{IN}$ )	0V to +5.5V
Output Voltage ( $V_{OUT}$ )	0V to $V_{CC}$
Operating Temperature ( $T_{OPR}$ )	-40°C to +85°C
Input Rise and Fall Time ( $t_r, t_f$ )	
$V_{CC} = 3.3V \pm 0.3V$	0 ns/V ~ 100 ns/V
$V_{CC} = 5.0V \pm 0.5V$	0 ns/V ~ 20 ns/V

**Note 1:** Absolute Maximum Ratings are values beyond which the device may be damaged or have its useful life impaired. The databook specifications should be met, without exception, to ensure that the system design is reliable over its power supply, temperature, and output/input loading variables. Fairchild does not recommend operation outside databook specifications.

**Note 2:** Unused inputs must be held HIGH or LOW. They may not float.

**DC Electrical Characteristics**

Symbol	Parameter	$V_{CC}$ (V)	$T_A = 25^\circ\text{C}$			$T_A = -40^\circ\text{C to } +85^\circ\text{C}$		Units	Conditions	
			Min	Typ	Max	Min	Max			
$V_{IH}$	HIGH Level	2.0	1.5			1.5		V		
	Input Voltage	3.0 - 5.5	$0.7 V_{CC}$			$0.7 V_{CC}$				
$V_{IL}$	LOW Level	2.0		0.5		0.5		V		
	Input Voltage	3.0 - 5.5		$0.3 V_{CC}$		$0.3 V_{CC}$				
$V_{OH}$	HIGH Level	2.0	1.9	2.0		1.9		V	$V_{IN} = V_{IH}$ or $V_{IL}$	$I_{OH} = -50 \mu\text{A}$
		3.0	2.9	3.0		2.9				
	4.5	4.4	4.5		4.4		$I_{OH} = -4 \text{ mA}$ $I_{OH} = -8 \text{ mA}$			
	3.0	2.58			2.48					
4.5	3.94			3.80						
$V_{OL}$	LOW Level	2.0		0.0	0.1		0.1	V	$V_{IN} = V_{IH}$ or $V_{IL}$	$I_{OL} = 50 \mu\text{A}$
		3.0		0.0	0.1		0.1			
	4.5		0.0	0.1		0.1	$I_{OL} = 4 \text{ mA}$ $I_{OL} = 8 \text{ mA}$			
	3.0			0.36		0.44				
4.5			0.36		0.44					
$I_{OZ}$	3-STATE Output Off-State Current	5.5			$\pm 0.25$		$\pm 2.5$	$\mu\text{A}$	$V_{IN} = V_{IH}$ or $V_{IL}$ $V_{OUT} = V_{CC}$ or GND	
$I_{IN}$	Input Leakage Current	0 - 5.5			$\pm 0.1$		$\pm 1.0$	$\mu\text{A}$	$V_{IN} = 5.5V$ or GND	
$I_{CC}$	Quiescent Supply Current	5.5			4.0		40.0	$\mu\text{A}$	$V_{IN} = V_{CC}$ or GND	

**Noise Characteristics**

Symbol	Parameter	$V_{CC}$ (V)	$T_A = 25^\circ\text{C}$		Units	Conditions
			Typ	Limits		
$V_{OLP}$ (Note 3)	Quiet Output Maximum	5.0	0.6	0.9	V	$C_L = 50 \text{ pF}$
	Dynamic $V_{OL}$					
$V_{OLV}$ (Note 3)	Quiet Output Minimum	5.0	-0.6	-0.9	V	$C_L = 50 \text{ pF}$
	Dynamic $V_{OL}$					
$V_{IHD}$ (Note 3)	Minimum HIGH Level	5.0		3.5	V	$C_L = 50 \text{ pF}$
	Dynamic Input Voltage					
$V_{ILD}$ (Note 3)	Maximum HIGH Level	5.0		1.5	V	$C_L = 50 \text{ pF}$
	Dynamic Input Voltage					

**Note 3:** Parameter guaranteed by design.

## AC Electrical Characteristics

Symbol	Parameter	V <sub>CC</sub> (V)	T <sub>A</sub> = 25°C			T <sub>A</sub> = -40°C to +85°C		Units	Conditions	
			Min	Typ	Max	Min	Max			
t <sub>PLH</sub>	Propagation Delay Time	3.3 ± 0.3		5.8	8.4	1.0	10.0	ns	C <sub>L</sub> = 15 pF C <sub>L</sub> = 50 pF C <sub>L</sub> = 15 pF C <sub>L</sub> = 50 pF	
t <sub>PHL</sub>			8.3	11.9	1.0	13.5				
		5.0 ± 0.5		3.9	5.5	1.0	6.5	ns		
				5.4	7.5	1.0	8.5			
t <sub>PZL</sub>	3-STATE Output Enable Time	3.3 ± 0.3		6.6	10.6	1.0	12.5	ns	R <sub>L</sub> = 1 kΩ C <sub>L</sub> = 15 pF C <sub>L</sub> = 50 pF C <sub>L</sub> = 15 pF C <sub>L</sub> = 50 pF	
t <sub>PZH</sub>				9.1	14.1	1.0	16.0			
		5.0 ± 0.5			4.7	7.3	1.0	8.5		ns
					6.2	9.3	1.0	10.5		
t <sub>PLZ</sub>	3-STATE Output Disable Time	3.3 ± 0.3		10.3	14.0	1.0	16.0	ns	R <sub>L</sub> = 1 kΩ C <sub>L</sub> = 50 pF C <sub>L</sub> = 50 pF	
t <sub>PHZ</sub>			5.0 ± 0.5		6.7	9.2	1.0			10.5
t <sub>OSSLH</sub>	Output to Output Skew	3.3 ± 0.3			1.5		1.5	ns	(Note 4) C <sub>L</sub> = 50 pF C <sub>L</sub> = 50 pF	
t <sub>OSSLH</sub>			5.0 ± 0.5			1.0				1.0
C <sub>IN</sub>	Input Capacitance			4	10		10	pF	V <sub>CC</sub> = Open	
C <sub>OUT</sub>	Output Capacitance			6				pF	V <sub>CC</sub> = 5.0V	
C <sub>PD</sub>	Power Dissipation Capacitance			19				pF	(Note 5)	

**Note 4:** Parameter guaranteed by design.  $t_{OSSLH} = |t_{PLHmax} - t_{PLHmin}|$ ;  $t_{OSSLH} = |t_{PHLmax} - t_{PHLmin}|$ .

**Note 5:** C<sub>PD</sub> is defined as the value of the internal equivalent capacitance which is calculated from the operating current consumption without load. Average operating current can be obtained by the equation:  $I_{CC(OPR.)} = C_{PD} * V_{CC} * f_{IN} + I_{CC}/8$  (per bit).

**Physical Dimensions** inches (millimeters) unless otherwise noted



**20-Lead Small Outline Integrated Circuit (SOIC), JEDEC MS-013, 0.300" Wide  
Package Number M20B**

**Physical Dimensions** inches (millimeters) unless otherwise noted (Continued)



LAND PATTERN RECOMMENDATION

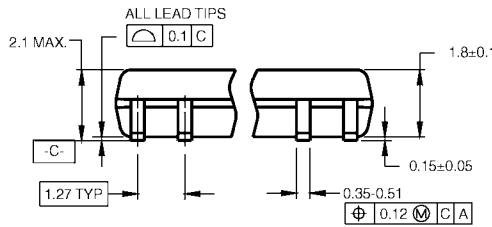

DIMENSIONS ARE IN MILLIMETERS



- NOTES:  
 A. CONFORMS TO EIAJ EDR-7320 REGISTRATION, ESTABLISHED IN DECEMBER, 1998.  
 B. DIMENSIONS ARE IN MILLIMETERS.  
 C. DIMENSIONS ARE EXCLUSIVE OF BURRS, MOLD FLASH, AND TIE BAR EXTRUSIONS.

M20DRevB1

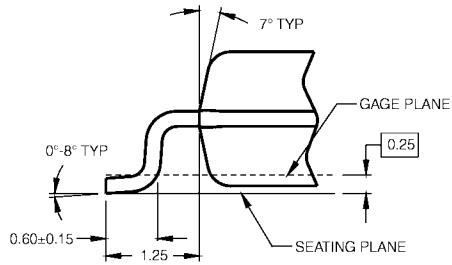

DETAIL A

**Pb-Free 20-Lead Small Outline Package (SOP), EIAJ TYPE II, 5.3mm Wide Package Number M20D**

**Physical Dimensions** inches (millimeters) unless otherwise noted (Continued)

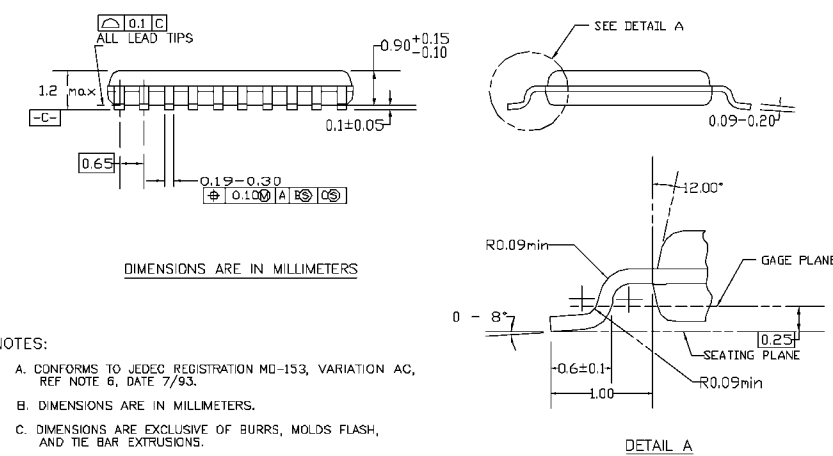
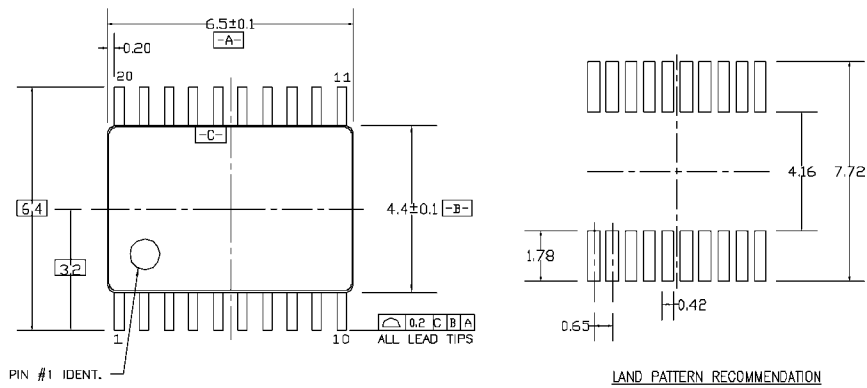

DIMENSIONS ARE IN MILLIMETERS

- NOTES:
- A. CONFORMS TO JEDEC REGISTRATION MO-153, VARIATION AC, REF NOTE 6, DATE 7/93.
  - B. DIMENSIONS ARE IN MILLIMETERS.
  - C. DIMENSIONS ARE EXCLUSIVE OF BURRS, MOLDS FLASH, AND TIE BAR EXTRUSIONS.
  - D. DIMENSIONS AND TOLERANCES PER ANSI Y14.5M, 1982.

MTC20REV D1

**20-Lead Thin Shrink Small Outline Package (TSSOP), JEDEC MO-153, 4.4mm Wide Package Number MTC20**

**Physical Dimensions** inches (millimeters) unless otherwise noted (Continued)

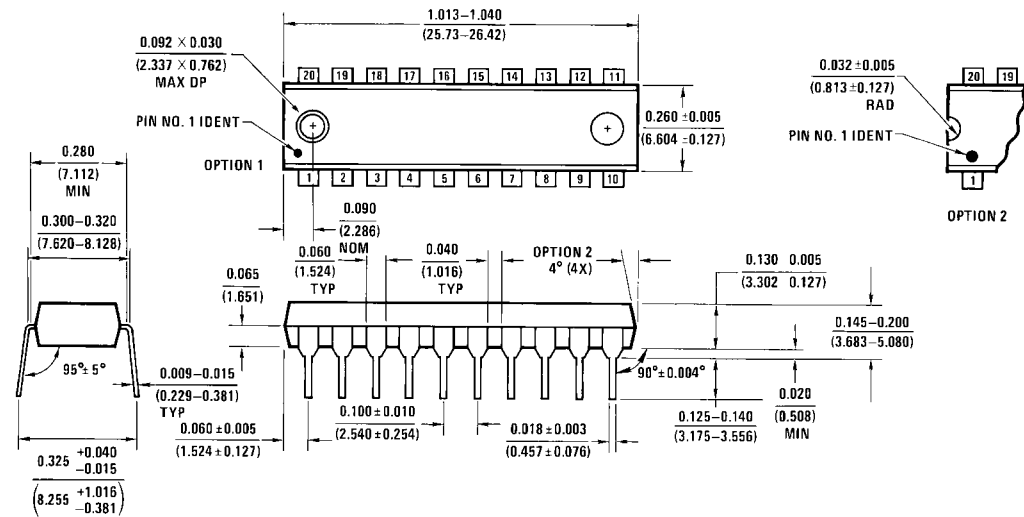

20-Lead Plastic Dual-In-Line Package (PDIP), JEDEC MS-001, 0.300" Wide Package Number N20A

Fairchild does not assume any responsibility for use of any circuitry described, no circuit patent licenses are implied and Fairchild reserves the right at any time without notice to change said circuitry and specifications.

**LIFE SUPPORT POLICY**

FAIRCHILD'S PRODUCTS ARE NOT AUTHORIZED FOR USE AS CRITICAL COMPONENTS IN LIFE SUPPORT DEVICES OR SYSTEMS WITHOUT THE EXPRESS WRITTEN APPROVAL OF THE PRESIDENT OF FAIRCHILD SEMICONDUCTOR CORPORATION. As used herein:

1. Life support devices or systems are devices or systems which, (a) are intended for surgical implant into the body, or (b) support or sustain life, and (c) whose failure to perform when properly used in accordance with instructions for use provided in the labeling, can be reasonably expected to result in a significant injury to the user.
2. A critical component in any component of a life support device or system whose failure to perform can be reasonably expected to cause the failure of the life support device or system, or to affect its safety or effectiveness.

[www.fairchildsemi.com](http://www.fairchildsemi.com)