

MC14503B

Hex Non-Inverting 3-State Buffer

The MC14503B is a hex non-inverting buffer with 3-state outputs, and a high current source and sink capability. The 3-state outputs make it useful in common bussing applications. Two disable controls are provided. A high level on the Disable A input causes the outputs of buffers 1 through 4 to go into a high impedance state and a high level on the Disable B input causes the outputs of buffers 5 and 6 to go into a high impedance state.

Features

- 3-State Outputs
- TTL Compatible — Will Drive One TTL Load Over Full Temperature Range
- Supply Voltage Range = 3.0 Vdc to 18 Vdc
- Two Disable Controls for Added Versatility
- Pin for Pin Replacement for MM80C97 and 340097
- Pb-Free Packages are Available*

MAXIMUM RATINGS (Voltages Referenced to V_{SS}) (Note 1)

Parameter	Symbol	Value	Unit
DC Supply Voltage Range	V_{DD}	-0.5 to +18.0	V
Input or Output Voltage Range (DC or Transient)	V_{in}, V_{out}	-0.5 to V_{DD} + 0.5	V
Input Current (DC or Transient) per Pin	I_{in}	± 10	mA
Output Current (DC or Transient) per Pin	I_{out}	± 25	mA
Power Dissipation, per Package (Note 2)	P_D	500	mW
Ambient Temperature Range	T_A	-55 to +125	$^{\circ}C$
Storage Temperature Range		-65 to +150	$^{\circ}C$
Lead Temperature (8-Second Soldering)		260	$^{\circ}C$

Stresses exceeding Maximum Ratings may damage the device. Maximum Ratings are stress ratings only. Functional operation above the Recommended Operating Conditions is not implied. Extended exposure to stresses above the Recommended Operating Conditions may affect device reliability.

1. Maximum Ratings are those values beyond which damage to the device may occur.
2. Temperature Derating:
Plastic "P and D/DW" Packages: - 7.0 mW/ $^{\circ}C$ From 65 $^{\circ}C$ To 125 $^{\circ}C$

This device contains protection circuitry to guard against damage due to high static voltages or electric fields. However, precautions must be taken to avoid applications of any voltage higher than maximum rated voltages to this high-impedance circuit. For proper operation, V_{in} and V_{out} should be constrained to the range $V_{SS} \leq (V_{in} \text{ or } V_{out}) \leq V_{DD}$.

Unused inputs must always be tied to an appropriate logic voltage level (e.g., either V_{SS} or V_{DD}). Unused outputs must be left open.

*For additional information on our Pb-Free strategy and soldering details, please download the ON Semiconductor Soldering and Mounting Techniques Reference Manual, SOLDERRM/D.



ON Semiconductor®

<http://onsemi.com>

MARKING DIAGRAMS

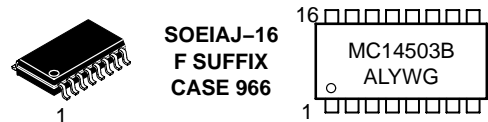
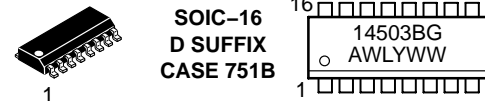
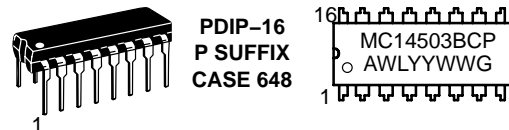

A = Assembly Location
WL, L = Wafer Lot
YY, Y = Year
WW, W = Work Week
G = Pb-Free Package

ORDERING INFORMATION

See detailed ordering and shipping information in the package dimensions section on page 2 of this data sheet.

MC14503B

PIN ASSIGNMENT

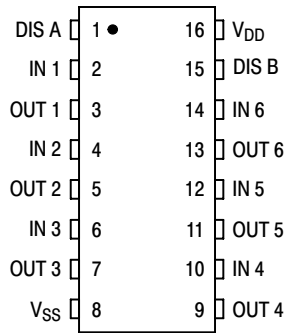

TRUTH TABLE

In_n	Appropriate Disable Input	Out_n
0	0	0
1	0	1
X	1	High Impedance

X = Don't Care

LOGIC DIAGRAM

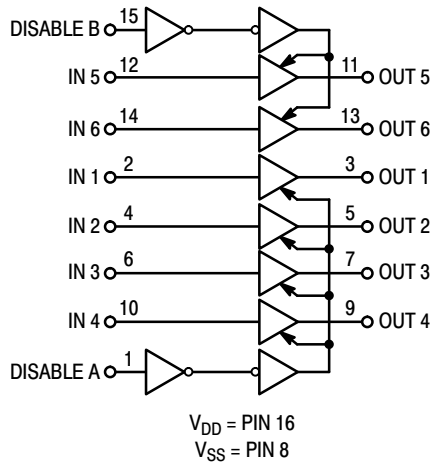

CIRCUIT DIAGRAM

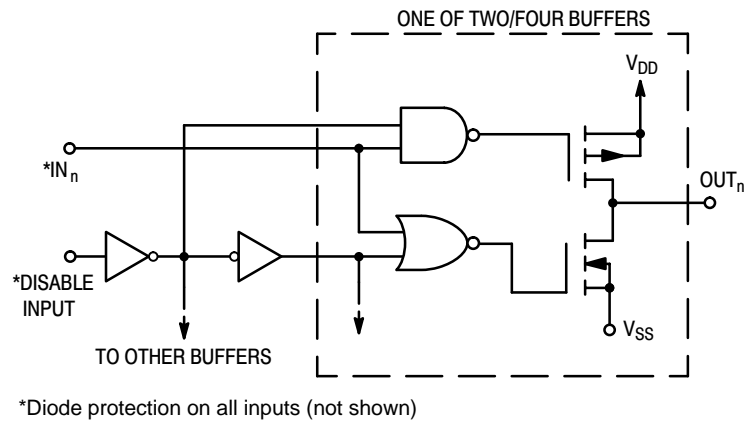

ORDERING INFORMATION

Device	Package	Shipping†
MC14503BCP	PDIP-16	25 / Rail
MC14503BCPG	PDIP-16 (Pb-Free)	
MC14503BD	SOIC-16	48 / Rail
MC14503BDG	SOIC-16 (Pb-Free)	
MC14503BDR2	SOIC-16	2500 / Tape & Reel
MC14503BDR2G	SOIC-16 (Pb-Free)	
MC14503BFEL	SOEIAJ-16	2000 / Tape & Reel
MC14503BFELG	SOEIAJ-16 (Pb-Free)	

†For information on tape and reel specifications, including part orientation and tape sizes, please refer to our Tape and Reel Packaging Specifications Brochure, BRD8011/D.

MC14503B

ELECTRICAL CHARACTERISTICS (Voltages Referenced to V_{SS})

Characteristic	Symbol	V_{DD} Vdc	- 55°C		25°C			125°C		Unit
			Min	Max	Min	Typ (Note 3)	Max	Min	Max	
Output Voltage $V_{in} = 0$ $V_{in} = V_{DD}$	"0" Level V_{OL}	5.0	-	0.05	-	0	0.05	-	0.05	Vdc
		10	-	0.05	-	0	0.05	-	0.05	
		15	-	0.05	-	0	0.05	-	0.05	
	"1" Level V_{OH}	5.0	4.95	-	4.95	5.0	-	4.95	-	Vdc
		10	9.95	-	9.95	10	-	9.95	-	
		15	14.95	-	14.95	15	-	14.95	-	
Input Voltage ($V_O = 3.6$ or 1.4 Vdc) ($V_O = 7.2$ or 2.8 Vdc) ($V_O = 11.5$ or 3.5 Vdc) ($V_O = 1.4$ or 3.6 Vdc) ($V_O = 2.8$ or 7.2 Vdc) ($V_O = 3.5$ or 11.5 Vdc)	"0" Level V_{IL}	5.0	-	1.5	-	2.25	1.5	-	1.5	Vdc
		10	-	3.0	-	4.50	3.0	-	3.0	
		15	-	4.0	-	6.75	4.0	-	4.0	
	"1" Level V_{IH}	5.0	3.5	-	3.5	2.75	-	3.5	-	Vdc
		10	7.0	-	7.0	5.50	-	7.0	-	
		15	11	-	11	8.25	-	11	-	
Output Drive Current ($V_{OH} = 2.5$ Vdc) ($V_{OH} = 2.5$ Vdc) ($V_{OH} = 4.6$ Vdc) ($V_{OH} = 9.5$ Vdc) ($V_{OH} = 13.5$ Vdc) ($V_{OL} = 0.4$ Vdc) ($V_{OL} = 0.4$ Vdc) ($V_{OL} = 0.5$ Vdc) ($V_{OL} = 1.5$ Vdc)	Source I_{OH}	4.5	-4.3	-	-3.6	-5.0	-	-2.5	-	mAdc
		5.0	-5.8	-	-4.8	-6.1	-	-3.0	-	
		10	-1.2	-	-1.02	-1.4	-	-0.7	-	
	Sink I_{OL}	4.5	2.2	-	1.8	2.1	-	1.2	-	mAdc
		5.0	2.6	-	2.1	2.3	-	1.3	-	
		10	6.5	-	5.5	6.2	-	3.8	-	
15	19.2	-	16.1	25	-	11.2	-			
Input Current	I_{in}	15	-	± 0.1	-	± 0.00001	± 0.1	-	± 1.0	μ Adc
Input Capacitance, ($V_{in} = 0$)	C_{in}	-	-	-	-	5.0	7.5	-	-	pF
Quiescent Current, (Per Package)	I_Q	5.0	-	1.0	-	0.002	1.0	-	30	μ Adc
		10	-	2.0	-	0.004	2.0	-	60	
		15	-	4.0	-	0.006	4.0	-	120	
Total Supply Current (Note 4, 5) (Dynamic plus Quiescent, Per Package) ($C_L = 50$ pF on all outputs) (All outputs switching, 50% Duty Cycle)	I_T	5.0	$I_T = (2.5 \mu\text{A/kHz}) f + I_{DD}$							μ Adc
		10	$I_T = (6.0 \mu\text{A/kHz}) f + I_{DD}$							
		15	$I_T = (10 \mu\text{A/kHz}) f + I_{DD}$							
3-State Output Leakage Current	I_{TL}	15	-	± 0.1	-	± 0.0001	± 0.1	-	± 3.0	μ Adc

3. Data labelled "Typ" is not to be used for design purposes but is intended as an indication of the IC's potential performance.

4. The formulas given are for the typical characteristics only at 25°C.

5. To calculate total supply current at loads other than 50 pF: $I_T(C_L) = I_T(50 \text{ pF}) + (C_L - 50) V f k$ where: I_T is in μA (per package), C_L in pF, $V = (V_{DD} - V_{SS})$ in volts, f in kHz is input frequency, and $k = 0.006$.

MC14503B

SWITCHING CHARACTERISTICS (Note 6) ($C_L = 50 \text{ pF}$, $T_A = 25^\circ\text{C}$)

Characteristic	Symbol	V_{DD} V_{CC}	All Types		Unit
			Typ (Note 7)	Max	
Output Rise Time $t_{TLH} = (0.5 \text{ ns/pF}) C_L + 20 \text{ ns}$ $t_{TLH} = (0.3 \text{ ns/pF}) C_L + 8.0 \text{ ns}$ $t_{TLH} = (0.2 \text{ ns/pF}) C_L + 8.0 \text{ ns}$	t_{TLH}	5.0 10 15	45 23 18	90 45 35	ns
Output Fall Time $t_{THL} = (0.5 \text{ ns/pF}) C_L + 20 \text{ ns}$ $t_{THL} = (0.3 \text{ ns/pF}) C_L + 8.0 \text{ ns}$ $t_{THL} = (0.2 \text{ ns/pF}) C_L + 8.0 \text{ ns}$	t_{THL}	5.0 10 15	45 23 18	90 45 35	ns
Turn-Off Delay Time, all Outputs $t_{PLH} = (0.3 \text{ ns/pF}) C_L + 60 \text{ ns}$ $t_{PLH} = (0.15 \text{ ns/pF}) C_L + 27 \text{ ns}$ $t_{PLH} = (0.1 \text{ ns/pF}) C_L + 20 \text{ ns}$	t_{PLH}	5.0 10 15	75 35 25	150 70 50	ns
Turn-On Delay Time, all Outputs $t_{PHL} = (0.3 \text{ ns/pF}) C_L + 60 \text{ ns}$ $t_{PHL} = (0.15 \text{ ns/pF}) C_L + 27 \text{ ns}$ $t_{PHL} = (0.1 \text{ ns/pF}) C_L + 20 \text{ ns}$	t_{PHL}	5.0 10 15	75 35 25	150 70 50	ns
3-State Propagation Delay Time Output "1" to High Impedance	t_{PHZ}	5.0 10 15	75 40 35	150 80 70	ns
Output "0" to High Impedance	t_{PLZ}	5.0 10 15	80 40 35	160 80 70	ns
High Impedance to "1" Level	t_{PZH}	5.0 10 15	65 25 20	130 50 40	ns
High Impedance to "0" Level	t_{PZL}	5.0 10 15	100 35 25	200 70 50	ns

6. The formulas given are for the typical characteristics only at 25°C .

7. Data labelled "Typ" is not to be used for design purposes but is intended as an indication of the IC's potential performance.

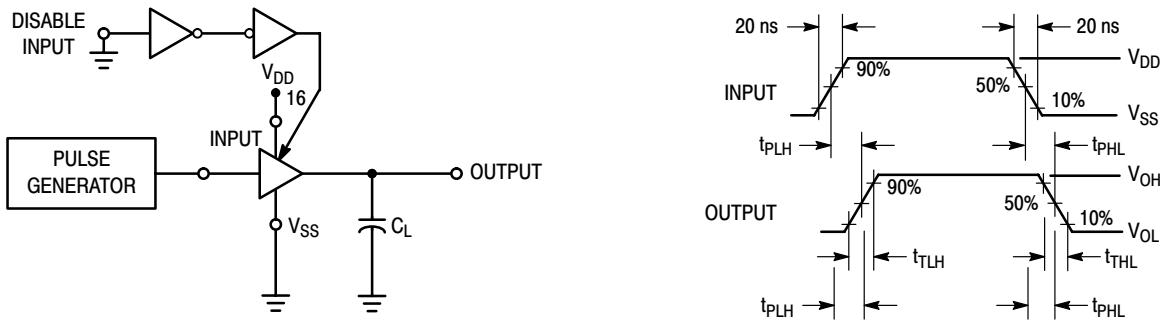
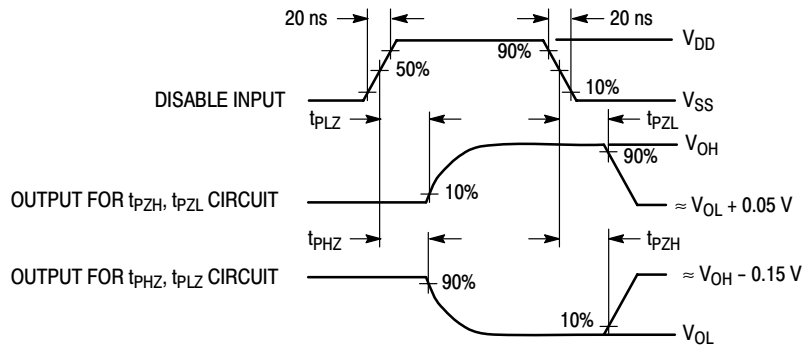
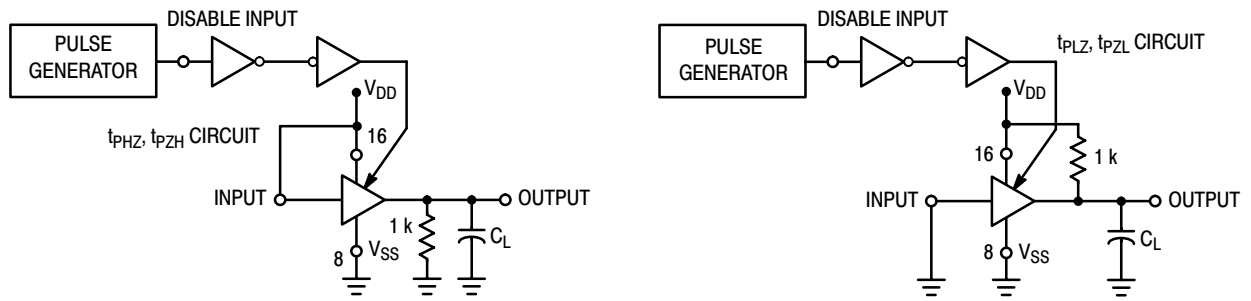

Figure 1. Switching Time Test Circuit and Waveforms (t_{TLH} , t_{THL} , t_{PHL} , and t_{PLH})

MC14503B

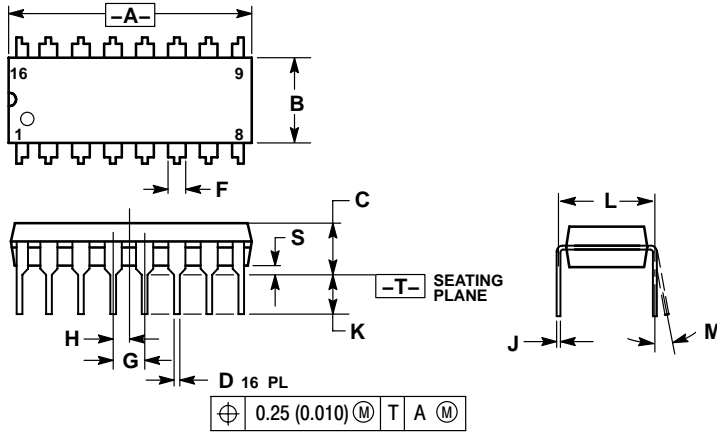

**Figure 2. 3-State AC Test Circuit and Waveforms
(t_{PLZ} , t_{PHZ} , t_{PZH} , t_{PZL})**

MC14503B

PACKAGE DIMENSIONS

PDIP-16
CASE 648-08
ISSUE T



- NOTES:
1. DIMENSIONING AND TOLERANCING PER ANSI Y14.5M, 1982.
 2. CONTROLLING DIMENSION: INCH.
 3. DIMENSION L TO CENTER OF LEADS WHEN FORMED PARALLEL.
 4. DIMENSION B DOES NOT INCLUDE MOLD FLASH.
 5. ROUNDED CORNERS OPTIONAL.

DIM	INCHES		MILLIMETERS	
	MIN	MAX	MIN	MAX
A	0.740	0.770	18.80	19.55
B	0.250	0.270	6.35	6.85
C	0.145	0.175	3.69	4.44
D	0.015	0.021	0.39	0.53
F	0.040	0.70	1.02	1.77
G	0.100 BSC		2.54 BSC	
H	0.050 BSC		1.27 BSC	
J	0.008	0.015	0.21	0.38
K	0.110	0.130	2.80	3.30
L	0.295	0.305	7.50	7.74
M	0°	10°	0°	10°
S	0.020	0.040	0.51	1.01

SOIC-16
CASE 751B-05
ISSUE J

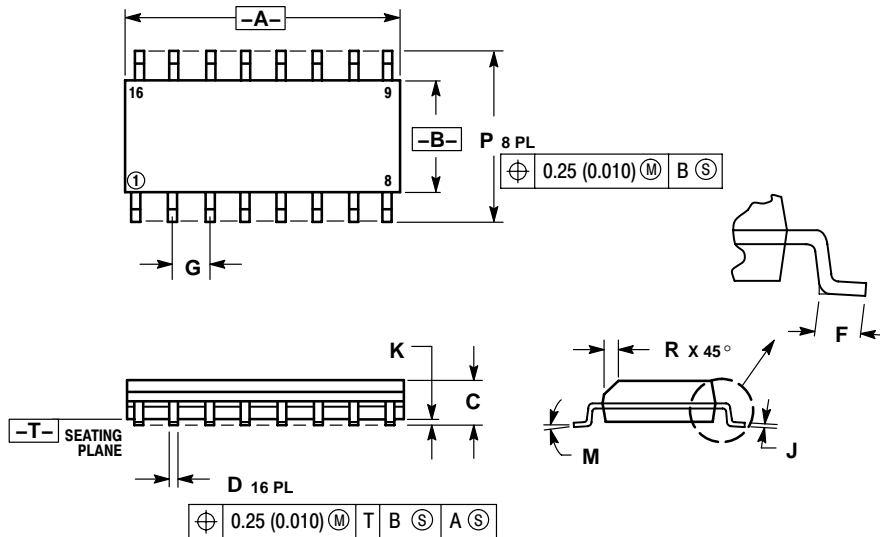

- NOTES:
1. DIMENSIONING AND TOLERANCING PER ANSI Y14.5M, 1982.
 2. CONTROLLING DIMENSION: MILLIMETER.
 3. DIMENSIONS A AND B DO NOT INCLUDE MOLD PROTRUSION.
 4. MAXIMUM MOLD PROTRUSION 0.15 (0.006) PER SIDE.
 5. DIMENSION D DOES NOT INCLUDE DAMBAR PROTRUSION. ALLOWABLE DAMBAR PROTRUSION SHALL BE 0.127 (0.005) TOTAL IN EXCESS OF THE D DIMENSION AT MAXIMUM MATERIAL CONDITION.

DIM	MILLIMETERS		INCHES	
	MIN	MAX	MIN	MAX
A	9.80	10.00	0.386	0.393
B	3.80	4.00	0.150	0.157
C	1.35	1.75	0.054	0.068
D	0.35	0.49	0.014	0.019
F	0.40	1.25	0.016	0.049
G	1.27 BSC		0.050 BSC	
J	0.19	0.25	0.008	0.009
K	0.10	0.25	0.004	0.009
M	0°	7°	0°	7°
P	5.80	6.20	0.229	0.244
R	0.25	0.50	0.010	0.019

MC14503B

PACKAGE DIMENSIONS

SOEIAJ-16
CASE 966-01
ISSUE A

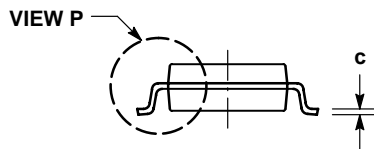
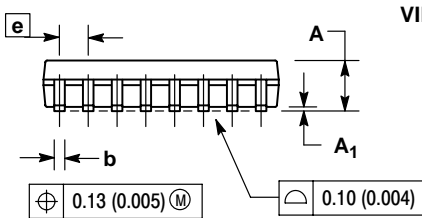
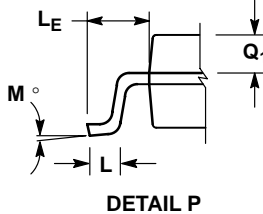
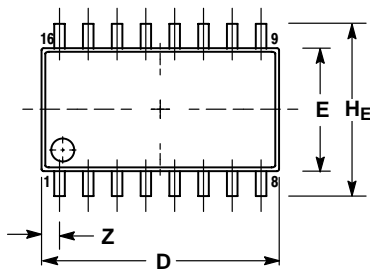

NOTES:

1. DIMENSIONING AND TOLERANCING PER ANSI Y14.5M, 1982.
2. CONTROLLING DIMENSION: MILLIMETER.
3. DIMENSIONS D AND E DO NOT INCLUDE MOLD FLASH OR PROTRUSIONS AND ARE MEASURED AT THE PARTING LINE. MOLD FLASH OR PROTRUSIONS SHALL NOT EXCEED 0.15 (0.006) PER SIDE.
4. TERMINAL NUMBERS ARE SHOWN FOR REFERENCE ONLY.
5. THE LEAD WIDTH DIMENSION (b) DOES NOT INCLUDE DAMBAR PROTRUSION. ALLOWABLE DAMBAR PROTRUSION SHALL BE 0.08 (0.003) TOTAL IN EXCESS OF THE LEAD WIDTH DIMENSION AT MAXIMUM MATERIAL CONDITION. DAMBAR CANNOT BE LOCATED ON THE LOWER RADIUS OR THE FOOT. MINIMUM SPACE BETWEEN PROTRUSIONS AND ADJACENT LEAD TO BE 0.46 (0.018).

DIM	MILLIMETERS		INCHES	
	MIN	MAX	MIN	MAX
A	---	2.05	---	0.081
A ₁	0.05	0.20	0.002	0.008
b	0.35	0.50	0.014	0.020
c	0.10	0.20	0.007	0.011
D	9.90	10.50	0.390	0.413
E	5.10	5.45	0.201	0.215
e	1.27 BSC		0.050 BSC	
HE	7.40	8.20	0.291	0.323
L	0.50	0.85	0.020	0.033
LE	1.10	1.50	0.043	0.059
M	0°	10°	0°	10°
Q ₁	0.70	0.90	0.028	0.035
Z	---	0.78	---	0.031

ON Semiconductor and are registered trademarks of Semiconductor Components Industries, LLC (SCILLC). SCILLC reserves the right to make changes without further notice to any products herein. SCILLC makes no warranty, representation or guarantee regarding the suitability of its products for any particular purpose, nor does SCILLC assume any liability arising out of the application or use of any product or circuit, and specifically disclaims any and all liability, including without limitation special, consequential or incidental damages. "Typical" parameters which may be provided in SCILLC data sheets and/or specifications can and do vary in different applications and actual performance may vary over time. All operating parameters, including "Typicals" must be validated for each customer application by customer's technical experts. SCILLC does not convey any license under its patent rights nor the rights of others. SCILLC products are not designed, intended, or authorized for use as components in systems intended for surgical implant into the body, or other applications intended to support or sustain life, or for any other application in which the failure of the SCILLC product could create a situation where personal injury or death may occur. Should Buyer purchase or use SCILLC products for any such unintended or unauthorized application, Buyer shall indemnify and hold SCILLC and its officers, employees, subsidiaries, affiliates, and distributors harmless against all claims, costs, damages, and expenses, and reasonable attorney fees arising out of, directly or indirectly, any claim of personal injury or death associated with such unintended or unauthorized use, even if such claim alleges that SCILLC was negligent regarding the design or manufacture of the part. SCILLC is an Equal Opportunity/Affirmative Action Employer. This literature is subject to all applicable copyright laws and is not for resale in any manner.

PUBLICATION ORDERING INFORMATION

LITERATURE FULFILLMENT:
Literature Distribution Center for ON Semiconductor
P.O. Box 5163, Denver, Colorado 80217 USA
Phone: 303-675-2175 or 800-344-3860 Toll Free USA/Canada
Fax: 303-675-2176 or 800-344-3867 Toll Free USA/Canada
Email: orderlit@onsemi.com

N. American Technical Support: 800-282-9855 Toll Free
USA/Canada
Europe, Middle East and Africa Technical Support:
Phone: 421 33 790 2910
Japan Customer Focus Center
Phone: 81-3-5773-3850

ON Semiconductor Website: www.onsemi.com
Order Literature: <http://www.onsemi.com/orderlit>
For additional information, please contact your local Sales Representative

MC14503B/D