

# LM4954 Boomer® Audio Power Amplifier Series

## High Voltage 3 Watt Audio Power Amplifier

### General Description

The LM4954 is an audio power amplifier primarily designed for demanding applications in mobile phones and other portable communication device applications. It is capable of delivering 2.4 Watts of continuous average power to an 8Ω BTL load with less than 1% THD+N from a 7V<sub>DC</sub> power supply.

Boomer audio power amplifiers are designed specifically to provide high quality output power with a minimal number of external components. The LM4954 does not require output coupling capacitors or bootstrap capacitors, and therefore is ideally suited for lower-power portable applications where minimal space and power consumption are primary requirements.

The LM4954 features a low-power consumption global shutdown mode which is achieved by driving the shutdown pin with logic low. Additionally, the LM4954 features an internal thermal shutdown protection mechanism.

The LM4954 contains advanced pop & click circuitry which eliminates noises that would otherwise occur during turn-on and turn-off transitions.

The LM4954 is unity-gain stable and can be configured by external gain-setting resistors.

### Key Specifications

- Wide Power Supply Voltage Range 2.7 ≤ V<sub>DD</sub> ≤ 9V
- Output Power: V<sub>DD</sub> = 7V, 1% THD+N 2.4W (typ)
- Quiescent power supply current 3mA (typ)
- PSRR: V<sub>DD</sub> = 5V and 3V at 217Hz 80dB (typ)
- Shutdown power supply current 0.01µA (typ)

### Features

- No output coupling capacitors, snubber networks or bootstrap capacitors required
- Unity gain stable
- Externally configurable gain
- Ultra low current active low shutdown mode
- BTL output can drive capacitive loads up to 100pF
- "Click and pop" suppression circuitry
- 2.7V - 9.0V operation
- Available in space-saving microSMD package

### Applications

- Mobile Phones
- PDAs

### Typical Application

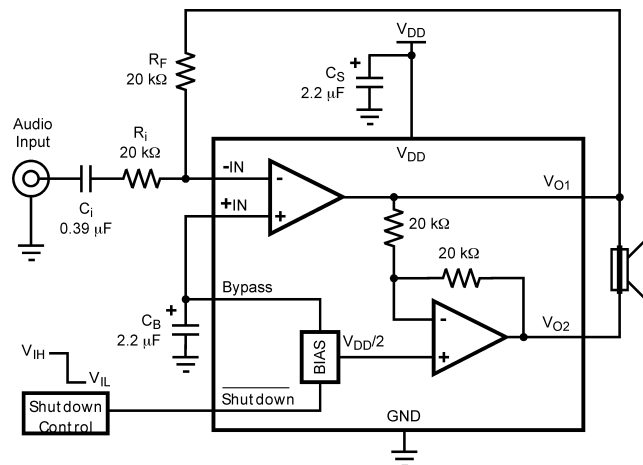
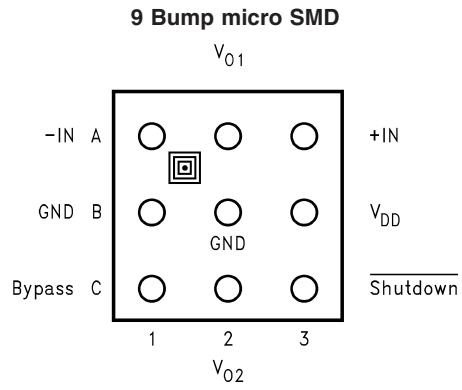

FIGURE 1. Typical Audio Amplifier Application Circuit

Boomer® is a registered trademark of National Semiconductor Corporation.

## Connection Diagrams



## 9 Bump micro SMD Marking

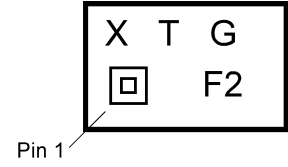

**Top View**  
**X - Date Code**  
**T - Die Traceability**  
**G - Boomer Family**  
**F2 - LM4954TL**

**Absolute Maximum Ratings** (Notes 1, 2)

If Military/Aerospace specified devices are required, please contact the National Semiconductor Sales Office/Distributors for availability and specifications.

Supply Voltage (Note 1)	9.5V
Storage Temperature	-65°C to +150°C
Input Voltage	-0.3V to $V_{DD} + 0.3V$
Power Dissipation (Note 3)	Internally Limited
ESD Susceptibility (Note 4)	2000V
ESD Susceptibility (Note 5)	200V
Junction Temperature	150°C

Thermal Resistance

 $\theta_{JA}$  (microSMD) (Note 10)

180°C/W

Soldering Information

See AN-112 "microSMD Wafers Level Chip Scale Package."

**Operating Ratings** (Notes 1, 2)

Temperature Range

 $T_{MIN} \leq T_A \leq T_{MAX}$  $-40^\circ\text{C} \leq T_A \leq 85^\circ\text{C}$ 

Supply Voltage

 $2.7V \leq V_{DD} \leq 9V$ **Electrical Characteristics  $V_{DD} = 7V$**  (Notes 1, 2)

The following specifications apply for  $V_{DD} = 7V$ ,  $A_{V-BTL} = 6dB$ , and  $R_L = 8\Omega$  unless otherwise specified. Limits apply for  $T_A = 25^\circ\text{C}$ .

Symbol	Parameter	Conditions	LM4954		Units (Limits)
			Typical	Limit	
			(Note 6)	(Notes 7, 8)	
$I_{DD}$	Quiescent Power Supply Current	$V_{IN} = 0V$ , $R_L = 8\Omega$ BTL	3	5	mA (max)
$I_{SD}$	Shutdown Current	$V_{SD} = GND$ (Note 9)	0.01	1	$\mu\text{A}$ (max)
$V_{OS}$	Output Offset Voltage		10	25	mV (max)
$P_O$	Output Power (Note 11)	THD+N = 1% (max); f = 1kHz	2.4	2.2	W (min)
		THD+N = 10% (max); f = 1kHz	3.0		W
THD+N	Total Harmonic Distortion + Noise	$P_O = 1W_{rms}$ ; f = 1kHz $A_{V-BTL} = 6dB$	0.1		%
		$P_O = 1W_{rms}$ ; f = 1kHz $A_{V-BTL} = 26dB$	0.4		%
PSRR	Power Supply Rejection Ratio	$V_{Ripple} = 200mV_{sine}$ p-p, $C_B = 2.2\mu\text{F}$ , Input terminated with $10\Omega$ to GND $f_{Ripple} = 217\text{Hz}$ , Input Referred	71	54	dB (min)
		$V_{Ripple} = 200mV_{sine}$ p-p, $C_B = 2.2\mu\text{F}$ , Input terminated with $10\Omega$ to ground $f_{Ripple} = 1\text{kHz}$ , Input Referred	71	55	dB (min)
$V_{SDIH}$	Shutdown High Input Voltage			1.2	V (min)
$V_{SDIL}$	Shutdown Low Input Voltage			0.4	V (max)
$T_{WU}$	Wake-up Time	$C_B = 2.2\mu\text{F}$	130		ms
$\epsilon_{OUT}$	Output Noise	A-Wtg, $A_{V-BTL} = 6dB$ Input terminated with $10\Omega$ to GND, Output Referred	20		$\mu\text{V}_{RMS}$
		A-Wtg, $A_{V-BTL} = 26dB$ Input terminated with $10\Omega$ to GND, Output Referred	100		$\mu\text{V}_{RMS}$
$R_{PD}$	Pull Down Resistor on Shutdown		75		k $\Omega$

### Electrical Characteristics $V_{DD} = 5V$ (Notes 1, 2)

The following specifications apply for  $V_{DD} = 5V$ ,  $A_{V-BTL} = 6dB$ , and  $R_L = 8\Omega$  unless otherwise specified. Limits apply for  $T_A = 25^\circ C$ .

Symbol	Parameter	Conditions	LM4954		Units (Limits)
			Typical	Limit	
			(Note 6)	(Notes 7, 8)	
$I_{DD}$	Quiescent Power Supply Current	$V_{IN} = 0V$ , $R_L = 8\Omega$ BTL	2.7	5	mA (max)
$I_{SD}$	Shutdown Current	$V_{SD} = GND$ (Note 9)	0.01	1	$\mu A$ (max)
$V_{OS}$	Output Offset Voltage		8	25	mV (max)
$P_o$	Output Power	THD+N = 1% (max); $f = 1kHz$	1.2	1.1	W (min)
THD+N	Total Harmonic Distortion + Noise	$P_o = 600mWrms$ ; $f = 1kHz$	0.1		%
PSRR	Power Supply Rejection Ratio	$V_{ripple} = 200mVsine$ p-p, $C_B = 2.2\mu F$ , Input terminated with $10\Omega$ to GND $f_{Ripple} = 217Hz$ , Input Referred	80	63	dB (min)
		$V_{ripple} = 200mVsine$ p-p, $C_B = 2.2\mu F$ , Input terminated with $10\Omega$ to GND $f_{Ripple} = 1kHz$ , Input Referred	80		dB
$V_{SDIH}$	Shutdown High Input Voltage			1.2	V (min)
$V_{SDIL}$	Shutdown Low Input Voltage			0.4	V (max)
$T_{WU}$	Wake-up Time	$C_B = 2.2\mu F$	130		ms
$\epsilon_{OUT}$	Output Noise	A-Wtg, Input terminated with $10\Omega$ to GND, Output referred	20		$\mu V_{RMS}$
$R_{PD}$	Pul Down Resistor on Shutdown		75		$k\Omega$

### Electrical Characteristics $V_{DD} = 3V$ (Notes 1, 2)

The following specifications apply for  $V_{DD} = 3V$ ,  $A_{V-BTL} = 6dB$ , and  $R_L = 8\Omega$  unless otherwise specified. Limits apply for  $T_A = 25^\circ C$ .

Symbol	Parameter	Conditions	LM4954		Units (Limits)
			Typical	Limit	
			(Note 6)	(Notes 7, 8)	
$I_{DD}$	Quiescent Power Supply Current	$V_{IN} = 0V$ , $R_L = 8\Omega$ BTL	2.5	5	mA (max)
$I_{SD}$	Shutdown Current	$V_{SD} = GND$ (Note 9)	0.01	1	$\mu A$ (max)
$V_{OS}$	Output Offset Voltage		5	25	mV (max)
$P_o$	Output Power	THD+N = 1% (max); $f = 1kHz$	380	360	mW (min)
THD+N	Total Harmonic Distortion + Noise	$P_o = 100mWrms$ ; $f = 1kHz$	0.18		%
PSRR	Power Supply Rejection Ratio	$V_{ripple} = 200mVsine$ p-p, $C_B = 2.2\mu F$ , Input teiminated with $10\Omega$ to GND, $f_{Ripple} = 217Hz$ , Input referred	80	63	dB (min)
		$V_{ripple} = 200mVsine$ p-p, $C_B = 2.2\mu F$ , Input teiminated with $10\Omega$ to GND, $f_{Ripple} = 1kHz$ , Input referred	80		dB
$V_{SDIH}$	Shutdown High Input Voltage			1.2	V (min)
$V_{SDIL}$	Shutdown Low Input Voltage			0.4	V (max)
$T_{WU}$	Wake-Up Time	$C_B = 2.2\mu F$	130		ms
$\epsilon_{OUT}$	Output Noise	A-Wtg, Input terminated with $10\Omega$ to GND, Output referred	20		$\mu V_{RMS}$
$R_{PD}$	Pull Down Resistor on Shutdown		75		$k\Omega$

**Note 1:** All voltages are measured with respect to the ground pin, unless otherwise specified.

**Note 2:** *Absolute Maximum Ratings* indicate limits beyond which damage to the device may occur. *Operating Ratings* indicate conditions for which the device is functional, but do not guarantee specific performance limits. *Electrical Characteristics* state DC and AC electrical specifications under particular test conditions which guarantee specific performance limits. This assumes that the device is within the Operating Ratings. Specifications are not guaranteed for parameters where no limit is given, however, the typical value is a good indication of device performance.

**Note 3:** The maximum power dissipation must be derated at elevated temperatures and is dictated by  $T_{JMAX}$ ,  $\theta_{JA}$ , and the ambient temperature  $T_A$ . The maximum allowable power dissipation is  $P_{DMAX} = (T_{JMAX} - T_A) / \theta_{JA}$  or the number given in Absolute Maximum Ratings, whichever is lower. For the LM4954, see power derating curves for additional information.

**Note 4:** Human body model, 100pF discharged through a 1.5k $\Omega$  resistor.

**Note 5:** Machine Model, 220pF – 240pF discharged through all pins.

**Note 6:** Typical specifications are specified at 25°C and represent the parametric norm.

**Note 7:** Tested limits are guaranteed to National's AOQL (Average Outgoing Quality Level).

**Note 8:** Datasheet min/max specification limits are guaranteed by design, test, or statistical analysis.

**Note 9:** Shutdown current is measured in a normal room environment. Exposure to direct sunlight in the TL package will increase  $I_{SD}$  by a minimum of 2 $\mu$ A.

**Note 10:** All bumps have the same thermal resistance and contribute equally when used to lower thermal resistance. The  $\theta_{JA}$  in the **Thermal Resistance** section is for the ITL package without any heat spreading planes on the PCB.

**Note 11:** The demo board shown has 1.1in<sup>2</sup> (710mm<sup>2</sup>) heat spreading planes on the two internal layers and the bottom layer. The bottom internal layer is electrically  $V_{DD}$  while the top internal and bottom layers are electrically GND. Thermal performance for the demo board is found on the Power Derating graph in the **Typical Performance Characteristics** section. 7V operation requires heat spreading planes for the thermal stability.

## External Components Description

(Figure 1)

Components		Functional Description
1.	$R_i$	Inverting input resistance which sets the closed-loop gain in conjunction with $R_f$ . This resistor also forms a high pass filter with $C_i$ at $f_c = 1/(2\pi R_i C_i)$ .
2.	$C_i$	Input coupling capacitor which blocks the DC voltage at the amplifiers input terminals. Also creates a highpass filter with $R_i$ at $f_c = 1/(2\pi R_i C_i)$ . Refer to the section, <b>Proper Selection of External Components</b> , for an explanation of how to determine the value of $C_i$ .
3.	$R_f$	Feedback resistance which sets the closed-loop gain in conjunction with $R_i$ . $A_{VD} = 2 * (R_f/R_i)$ .
4.	$C_S$	Supply bypass capacitor which provides power supply filtering. Refer to the <b>Power Supply Bypassing</b> section for information concerning proper placement and selection of the supply bypass capacitor.
5.	$C_B$	Bypass pin capacitor which provides half-supply filtering. Refer to the section, <b>Proper Selection of External Components</b> , for information concerning proper placement and selection of $C_B$ .

## Typical Performance Characteristics

**THD+N vs Output Power**  
 $V_{DD} = 7V, R_L = 8\Omega, A_V = 6dB,$   
 $f = 1kHz, 80kHz BW$

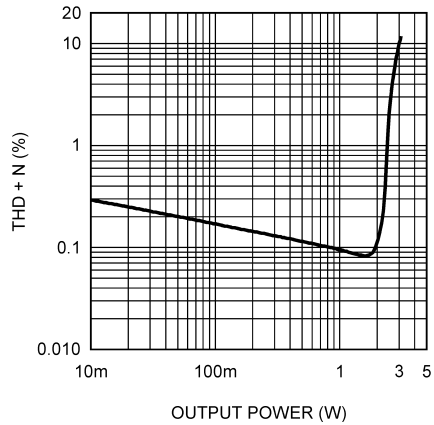

20129163

**THD+N vs Frequency**  
 $V_{DD} = 7V, R_L = 8\Omega, A_V = 6dB,$   
 $P_{OUT} = 600mW, 80kHz BW$

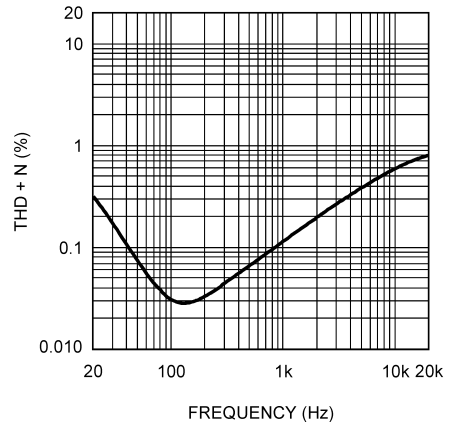

20129134

**THD+N vs Output Power**  
 $V_{DD} = 7V, R_L = 8\Omega, A_V = 26dB,$   
 $f = 1kHz, 80kHz BW$

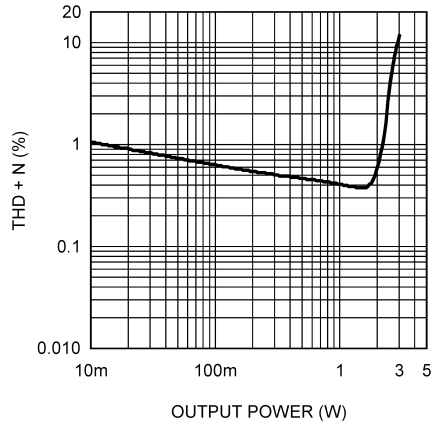

20129164

**THD+N vs Frequency**  
 $V_{DD} = 7V, R_L = 8\Omega, A_V = 26dB,$   
 $P_{OUT} = 600mW, 80kHz BW$

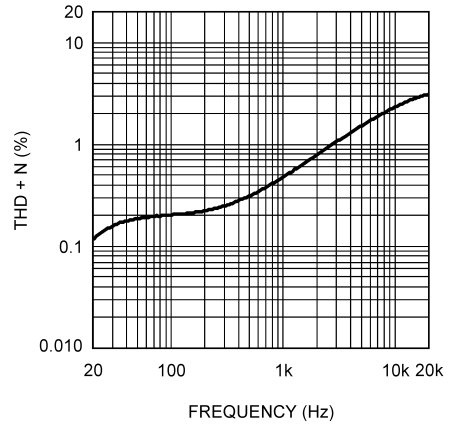

20129135

**THD+N vs Output Power**  
 $V_{DD} = 5V, R_L = 4\Omega, A_V = 6dB,$   
 $f = 1kHz, 80kHz BW$

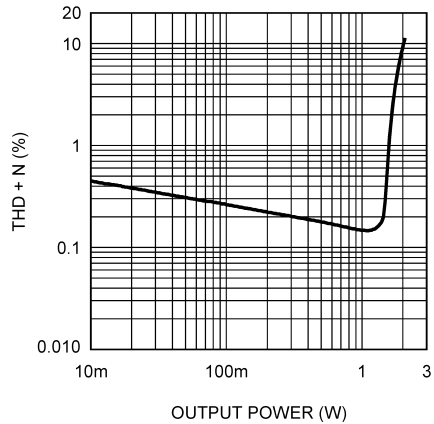

20129155

**THD+N vs Frequency**  
 $V_{DD} = 5V, R_L = 4\Omega, A_V = 6dB,$   
 $P_{OUT} = 100mW, 80kHz BW$

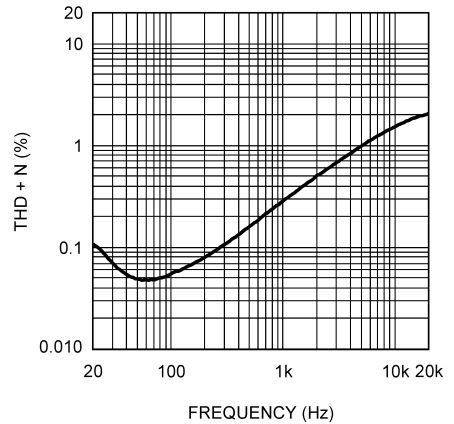

20129132

Typical Performance Characteristics (Continued)

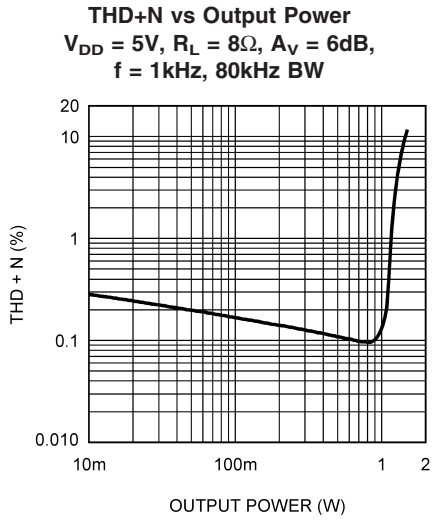

20129162

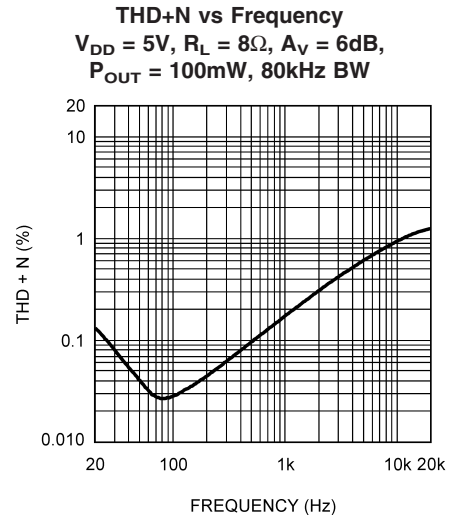

20129133

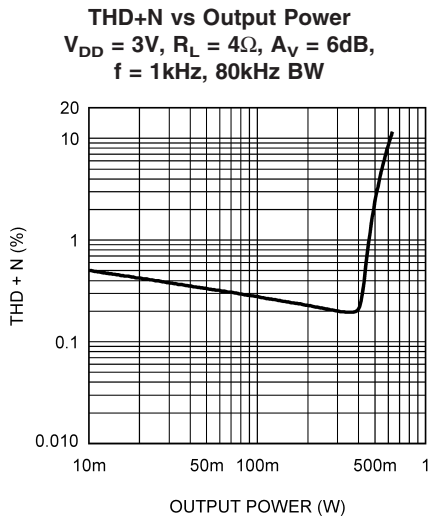

20129136

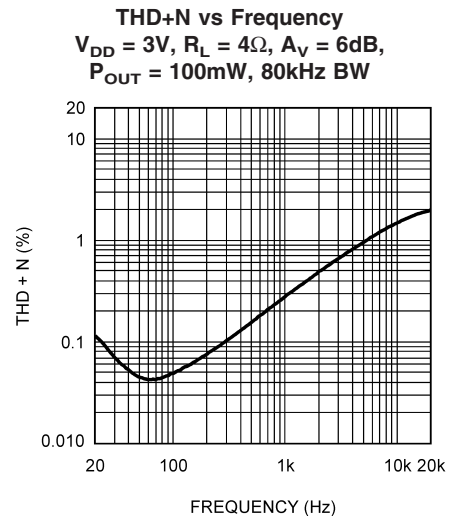

20129130

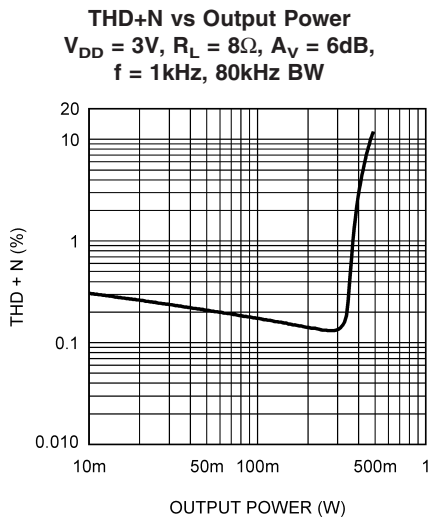

20129153

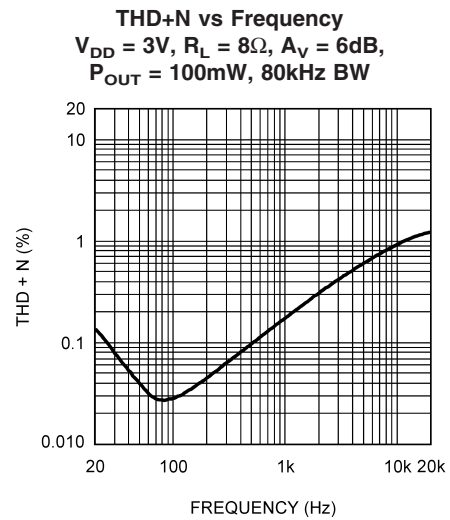

20129131

# Typical Performance Characteristics (Continued)

**THD+N vs Differential Gain**

$V_{DD} = 7V$ ,  $R_L = 8\Omega$ ,  
 $P_{OUT} = 600mW$ , 80kHz BW

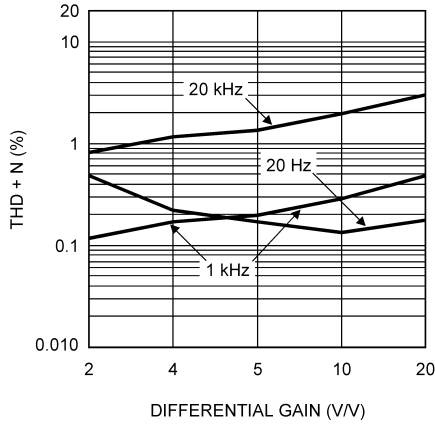

20129171

**PSRR vs Frequency**

$V_{DD} = 7V$ ,  $V_{RIPPLE} = 200mV_{P-P}$   
 Input Terminated, 80kHz BW

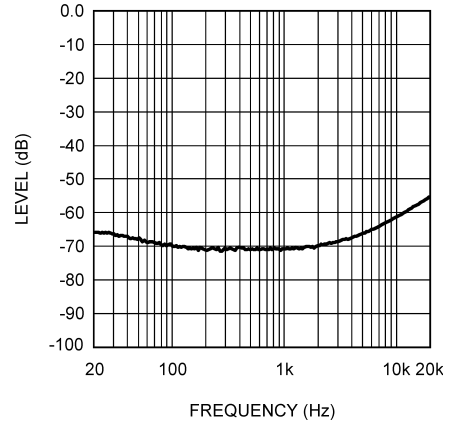

20129128

**PSRR vs Frequency**

$V_{DD} = 5V$ ,  $V_{RIPPLE} = 200mV_{P-P}$   
 Input Terminated, 80kHz BW

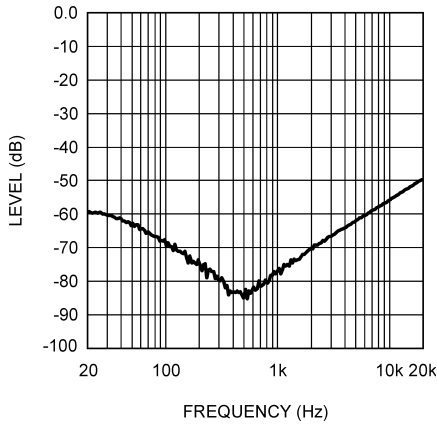

20129127

**PSRR vs Frequency**

$V_{DD} = 3V$ ,  $V_{RIPPLE} = 200mV_{P-P}$   
 Input Terminated, 80kHz BW

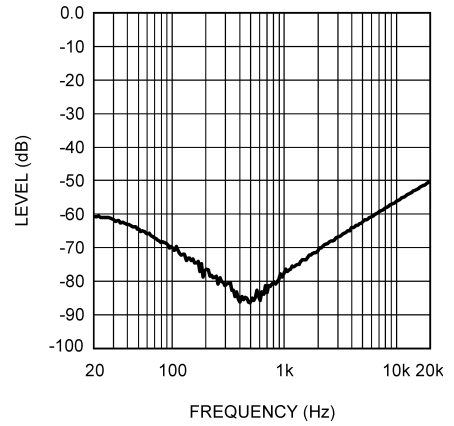

20129126

**Output Power vs Supply Voltage**

$R_L = 4\Omega$ ,  $A_V = 6dB$ , 80kHz BW

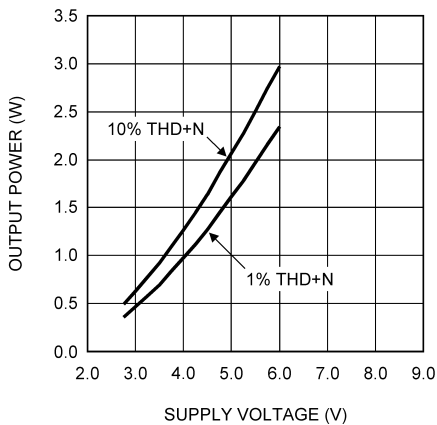

20129124

**Output Power vs Supply Voltage**

$R_L = 8\Omega$ ,  $A_V = 6dB$ , 80kHz BW

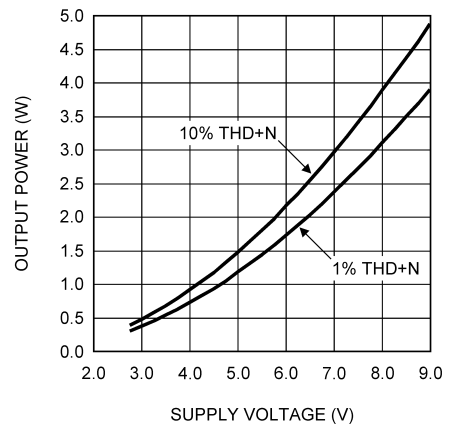

20129125



Typical Performance Characteristics (Continued)

Power Dissipation vs Output Power

$V_{DD} = 7V$ ,  $A_V = 6dB$ ,  
 $THD+N \leq 1\%$ , 80kHz BW

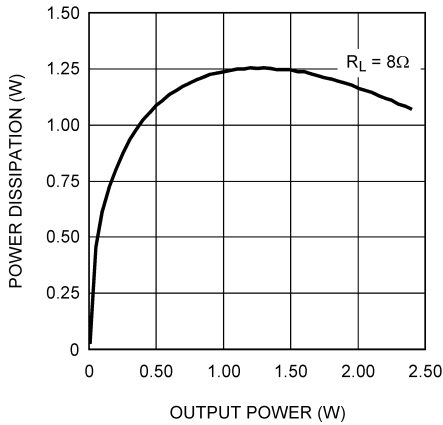

20129123

Power Dissipation vs Output Power

$V_{DD} = 5V$ ,  $A_V = 6dB$ ,  
 $THD+N \leq 1\%$ , 80kHz BW

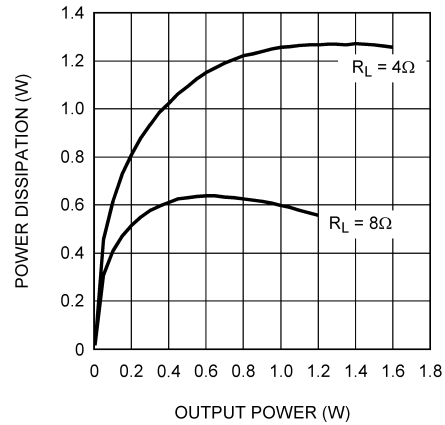

20129120

Power Dissipation vs Output Power

$V_{DD} = 3V$ ,  $A_V = 6dB$ ,  
 $THD+N \leq 1\%$ , 80kHz BW

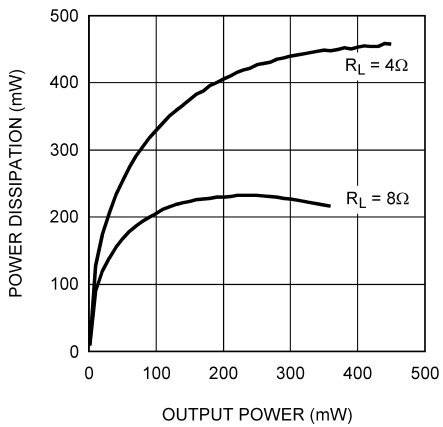

20129112

Power Derating – 9 bump  $\mu$ SMD

$P_{DMAX} = 1.26W$ ,  $V_{DD} = 7V$ ,  
 $R_L = 8\Omega$  (Notes 10, 11)

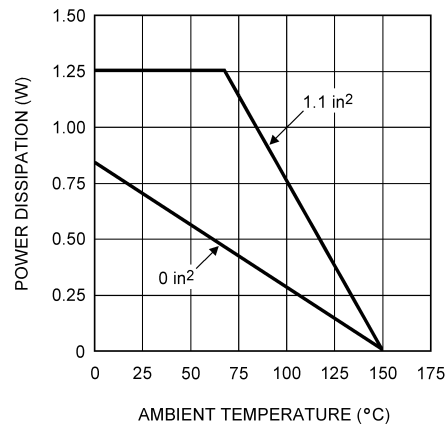

20129192

Shutdown Threshold vs Supply Voltage

$R_L = 8\Omega$ ,  $A_V = 6dB$ , 80kHz BW

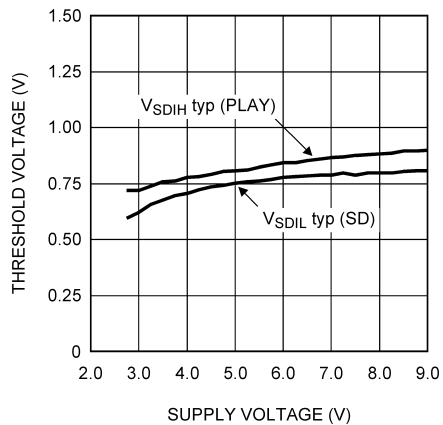

20129169

Supply Current vs Supply Voltage

$R_L = 8\Omega$

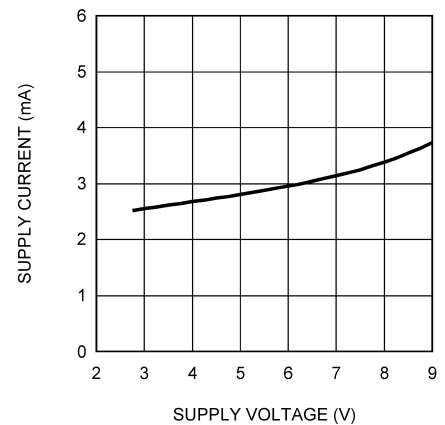

20129129

## Application Information

### BRIDGE CONFIGURATION EXPLANATION

As shown in *Figure 1*, the LM4954 has two operational amplifiers internally, allowing for a few different amplifier configurations. The first amplifier's gain is externally configurable, while the second amplifier is internally fixed in a unity-gain, inverting configuration. The closed-loop gain of the first amplifier is set by selecting the ratio of  $R_f$  to  $R_i$  while the second amplifier's gain is fixed by the two internal 20k $\Omega$  resistors. *Figure 1* shows that the output of amplifier one serves as the input to amplifier two which results in both amplifiers producing signals identical in magnitude, but out of phase by 180°. Consequently, the differential gain for the IC is

$$A_{VD} = 2 * (R_f/R_i)$$

By driving the load differentially through outputs Vo1 and Vo2, an amplifier configuration commonly referred to as "bridged mode" is established. Bridged mode operation is different from the classical single-ended amplifier configuration where one side of the load is connected to ground.

A bridge amplifier design has a few distinct advantages over the single-ended configuration, as it provides differential drive to the load, thus doubling output swing for a specified supply voltage. Four times the output power is possible as compared to a single-ended amplifier under the same conditions. This increase in attainable output power assumes that the amplifier is not current limited or clipped. In order to choose an amplifier's closed-loop gain without causing excessive clipping, please refer to the **Audio Power Amplifier Design** section.

A bridge configuration, such as the one used in LM4954, also creates a second advantage over single-ended amplifiers. Since the differential outputs, Vo1 and Vo2, are biased at half-supply, no net DC voltage exists across the load. This eliminates the need for an output coupling capacitor which is required in a single supply, single-ended amplifier configuration. Without an output coupling capacitor, the half-supply bias across the load would result in both increased internal IC power dissipation and also possible loudspeaker damage.

### POWER DISSIPATION

Power dissipation is a major concern when designing a successful amplifier, whether the amplifier is bridged or single-ended. A direct consequence of the increased power delivered to the load by a bridge amplifier is an increase in internal power dissipation. Since the LM4954 has two operational amplifiers in one package, the maximum internal power dissipation is four times that of a single-ended amplifier. The maximum power dissipation for a given application can be derived from the power dissipation graphs or from Equation 1.

$$P_{DMAX} = 4 * (V_{DD})^2 / (2\pi^2 R_L) \quad (1)$$

It is critical that the maximum junction temperature ( $T_{JMAX}$ ) of 150°C is not exceeded.  $T_{JMAX}$  can be determined from the power derating curves by using  $P_{DMAX}$  and the PC board foil area. By adding additional copper foil, the thermal resistance of the application can be reduced from the free air value, resulting in higher  $P_{DMAX}$ . Additional copper foil can be added to any of the leads connected to the LM4954. It is especially effective when connected to  $V_{DD}$ , GND, and the output pins. Refer to the application information on the LM4954 reference design board for an example of good heat sinking. If  $T_{JMAX}$  still exceeds 150°C, then additional changes must be made. These changes can include re-

duced supply voltage, higher load impedance, or reduced ambient temperature. Internal power dissipation is a function of output power. Refer to the **Typical Performance Characteristics** curves for power dissipation information for different output powers and output loading.

### POWER SUPPLY BYPASSING

As with any amplifier, proper supply bypassing is critical for low noise performance and high power supply rejection. The capacitor location on both the bypass and power supply pins should be as close to the device as possible. Typical applications employ a 5V regulator with 10 $\mu$ F tantalum or electrolytic capacitor and a ceramic bypass capacitor which aid in supply stability. This does not eliminate the need for bypassing the supply nodes of the LM4954. The selection of a bypass capacitor, especially  $C_B$ , is dependent upon PSRR requirements, click and pop performance (as explained in the section, **Proper Selection of External Components**), system cost, and size constraints.

### SHUTDOWN FUNCTION

In order to reduce power consumption while not in use, the LM4954 contains a shutdown pin to externally turn off the amplifier's bias circuitry. This shutdown feature turns the amplifier off when a logic low is placed on the shutdown pin. By switching the shutdown pin to ground, the LM4954 supply current draw will be minimized in idle mode. While the device will be disabled with shutdown pin voltages less than 0.4V<sub>DC</sub>, the idle current may be greater than the typical value of 0.01 $\mu$ A. (Idle current is measured with the shutdown pin tied to ground). The LM4954 has an internal 75k $\Omega$  pull-down resistor. If the shutdown pin is left floating the IC will automatically enter shutdown mode.

### PROPER SELECTION OF EXTERNAL COMPONENTS

Proper selection of external components in applications using integrated power amplifiers is critical to optimize device and system performance. While the LM4954 is tolerant of external component combinations, consideration to component values must be used to maximize overall system quality.

The LM4954 is unity-gain stable which gives the designer maximum system flexibility. The LM4954 should be used in low gain configurations to minimize THD+N values, and maximize the signal to noise ratio. Low gain configurations require large input signals to obtain a given output power. Input signals equal to or greater than 1 V<sub>rms</sub> are available from sources such as audio codecs. Please refer to the section, **Audio Power Amplifier Design**, for a more complete explanation of proper gain selection.

Besides gain, one of the major considerations is the closed-loop bandwidth of the amplifier. To a large extent, the bandwidth is dictated by the choice of external components shown in *Figure 1*. The input coupling capacitor,  $C_i$ , forms a first order high pass filter which limits low frequency response. This value should be chosen based on needed frequency response for a few distinct reasons.

### Selection Of Input Capacitor Size

Large input capacitors are both expensive and space hungry for portable designs. Clearly, a certain sized capacitor is needed to couple in low frequencies without severe attenuation. But in many cases the speakers used in portable systems, whether internal or external, have little ability to

## Application Information (Continued)

reproduce signals below 100Hz to 150Hz. Thus, using a large input capacitor may not increase actual system performance.

In addition to system cost and size, click and pop performance is affected by the size of the input coupling capacitor,  $C_i$ . A larger input coupling capacitor requires more charge to reach its quiescent DC voltage (nominally  $1/2V_{DD}$ ). This charge comes from the output via the feedback and is apt to create pops upon device enable. Thus, by minimizing the capacitor size based on necessary low frequency response, turn-on pops can be minimized.

Besides minimizing the input capacitor size, careful consideration should be paid to the bypass capacitor value. Choosing  $C_B$  equal to  $2.2\mu\text{F}$  along with a small value of  $C_i$  (in the range of  $0.1\mu\text{F}$  to  $0.39\mu\text{F}$ ), should produce a virtually clickless and popless shutdown function. While the device will function properly, (no oscillations or motorboating), with  $C_B$  equal to  $0.1\mu\text{F}$ .

## AUDIO POWER AMPLIFIER DESIGN

A designer must first determine the minimum supply rail to obtain the specified output power. By extrapolating from the Output Power vs Supply Voltage graphs in the **Typical Performance Characteristics** section, the supply rail can be easily found.

At this time, the designer must make sure that the power supply choice along with the output impedance does not violate the conditions explained in the **Power Dissipation** section.

Once the power dissipation equations have been addressed, the required differential gain can be determined from Equation 2.

$$A_{VD} \geq \sqrt{(P_O R_L)} / (V_{IN}) = V_{or\text{rms}} / V_{in\text{rms}} \quad (2)$$

$$A_{VD} = (R_f / R_i) \cdot 2$$

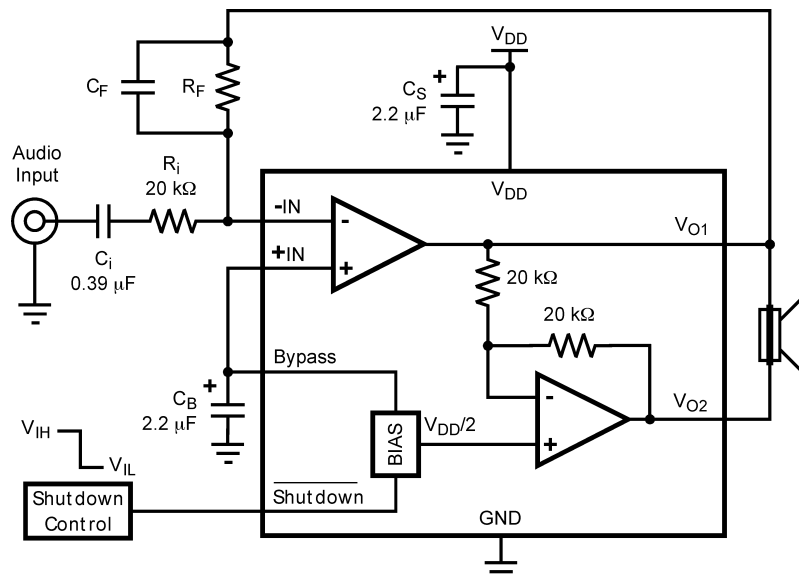

20129108

FIGURE 2. HIGHER GAIN AUDIO AMPLIFIER

The LM4954 is unity-gain stable and requires no external components besides gain-setting resistors, an input coupling capacitor, and proper supply bypassing in the typical application. However, if a closed-loop differential gain of greater than 10 is required, a feedback capacitor ( $C_F$ ) may be needed as shown in Figure 2 to bandwidth limit the amplifier. This feedback capacitor creates a low pass filter that eliminates possible high frequency oscillations. Care should be

taken when calculating the -3dB frequency in that an incorrect combination of  $R_F$  and  $C_F$  will cause rolloff before 20kHz. A typical combination of feedback resistor and capacitor that will not produce audio band high frequency rolloff is  $R_F = 20\text{k}\Omega$  and  $C_F = 25\text{pf}$ . These components result in a -3dB point of approximately 320 kHz. To calculate the value of the capacitor for a given -3dB point, use Equation 3 below:

$$C_F = 1 / (2\pi f_{3\text{dB}} R_F) \quad (3)$$

Application Information (Continued)

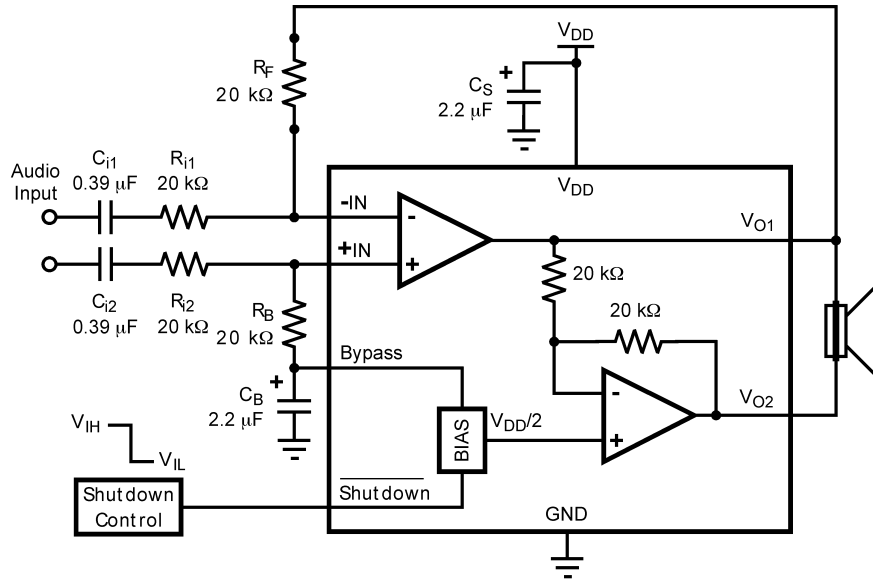

20129109

FIGURE 3. DIFFERENTIAL AMPLIFIER CONFIGURATION FOR LM4954

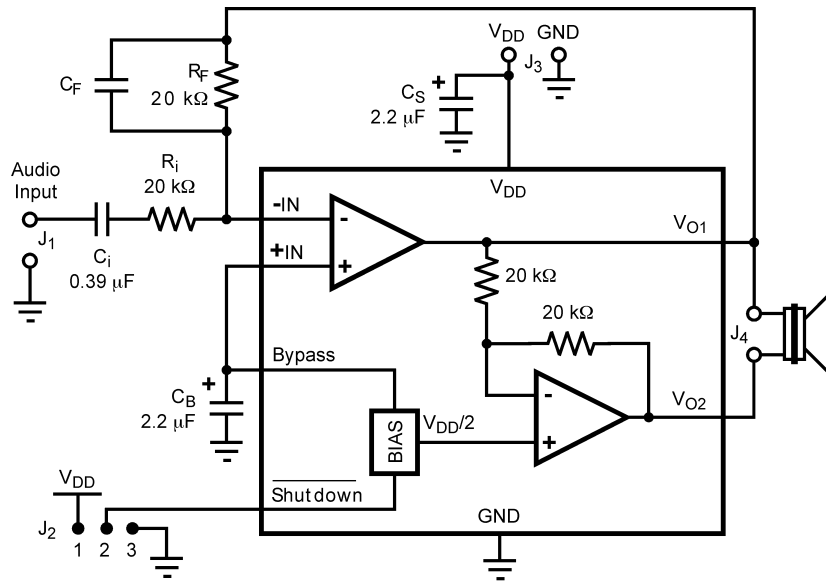

20129110

FIGURE 4. REFERENCE DESIGN BOARD SCHEMATIC

# Application Information (Continued)

LM4954 micro SMD BOARD ARTWORK (Note 10)

Composite View

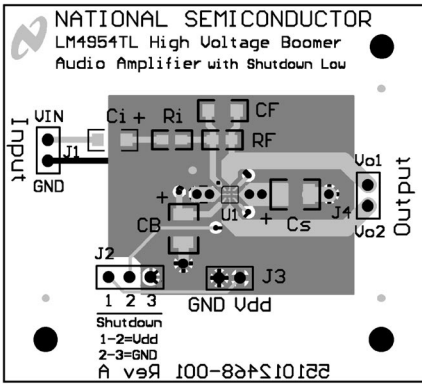

Silk Screen

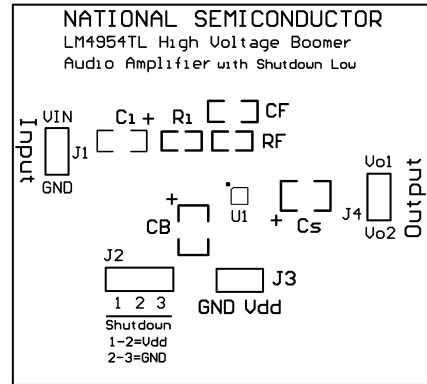

Top Layer

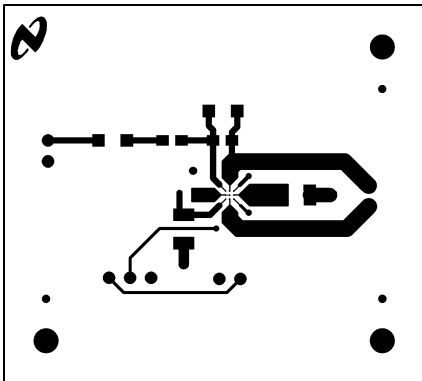

Internal Layer 1, GND

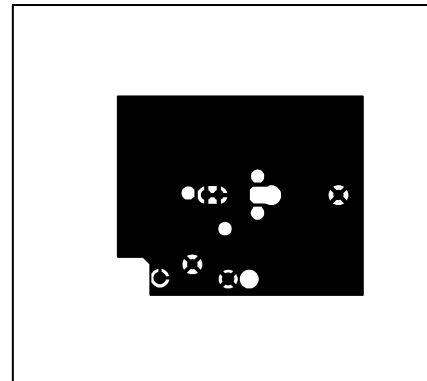

Internal Layer 2, V<sub>DD</sub>

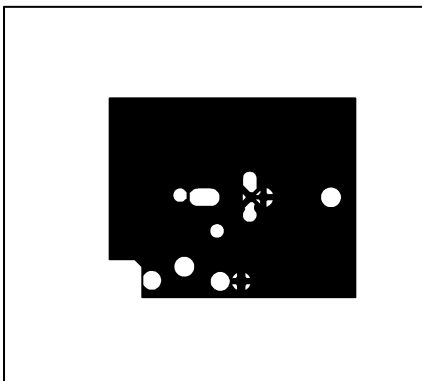

Bottom Layer

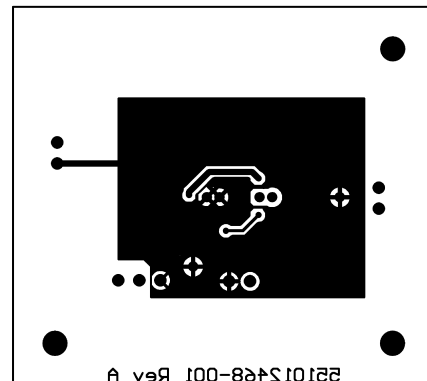

## Application Information (Continued)

**TABLE 1. Mono LM4954 Reference Design Boards Bill of Materials**

Designator	Value	Tolerance	Part Description	Comment
R <sub>i</sub>	20kΩ	1%	1/10W, 1% 0805 Resistor	
R <sub>F</sub>	20kΩ	1%	1/10W, 1% 0805 Resistor	
C <sub>i</sub>	0.39μF	10%	Ceramic 1206 Capacitor, 10%	
C <sub>F</sub>				Part not used
C <sub>S</sub>	2.2μF	10%	16V Tantalum 1210 Capacitor	
C <sub>B</sub>	2.2μF	10%	16V Tantalum 1210 Capacitor	
J <sub>1</sub> , J <sub>3</sub> , J <sub>4</sub>			0.100" 1x2 header, vertical mount	Input, Output, Vdd/GND
J <sub>2</sub>			0.100" 1x3 header, vertical mount	Shutdown control

### PCB LAYOUT GUIDELINES

This section provides practical guidelines for mixed signal PCB layout that involves various digital/analog power and ground traces. Designers should note that these are only "rule-of-thumb" recommendations and the actual results will depend heavily on the final layout.

### GENERAL MIXED SIGNAL LAYOUT RECOMMENDATIONS

#### Power and Ground Circuits

For a two layer mixed signal design, it is important to isolate the digital power and ground trace paths from the analog power and ground trace paths. Star trace routing techniques (bringing individual traces back to a central point rather than daisy chaining traces together in a serial manner) can have a major impact on low level signal performance. Star trace routing refers to using individual traces to feed power and ground to each circuit or even device. This technique requires a greater amount of design time but will not increase the final price of the board. The only extra parts required may be some jumpers.

#### Single-Point Power / Ground Connections

The analog power traces should be connected to the digital traces through a single point (link). A "Pi-filter" can be helpful in minimizing high frequency noise coupling between the analog and digital sections. It is further recommended to put digital and analog power traces over the corresponding digital and analog ground traces to minimize noise coupling.

#### Placement of Digital and Analog Components

All digital components and high-speed digital signals traces should be located as far away as possible from analog components and circuit traces.

#### Avoiding Typical Design / Layout Problems

Avoid ground loops or running digital and analog traces parallel to each other (side-by-side) on the same PCB layer. When traces must cross over each other do it at 90 degrees. Running digital and analog traces at 90 degrees to each other from the top to the bottom side as much as possible will minimize capacitive noise coupling and cross talk.

## Revision History

Rev	Date	Description
1.1	4/29/05	Added curves 71 and 72. Edited Note 10. Changed Av = 26dB to 6dB under 7V EC table. Edited SHUTDOWN FUNCTION under the Application section.
1.2	6/08/05	Removed all the LLP pkg references. Changed TLA09XXX into TLA0911A. Changed X1 and X2 measurements.
1.3	6/15/05	Fixed some typos. Initial WEB release.
1.4	6/20/05	Replaced curve 20129170 with 20129192.
1.5	6/22/05	Split Note 10 and added Note 11. <b>Re-released to the WEB.</b>

**Physical Dimensions** inches (millimeters) unless otherwise noted

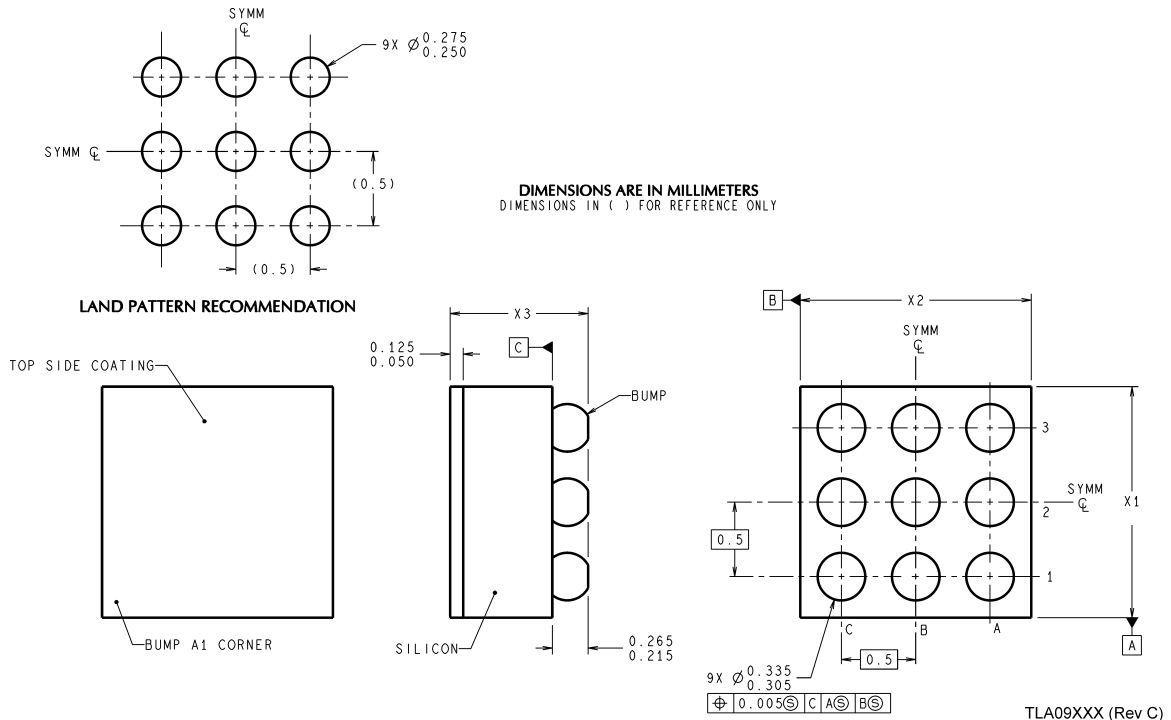

**9-Bump micro SMD**  
**Order Number LM4954TL, LM4954TLX**  
**NS Package Number TLA0911A**  
**X1 = 1.488±0.03 X2 = 1.488±0.03 X3 = 0.60±0.075**

National does not assume any responsibility for use of any circuitry described, no circuit patent licenses are implied and National reserves the right at any time without notice to change said circuitry and specifications.  
 For the most current product information visit us at [www.national.com](http://www.national.com).

**LIFE SUPPORT POLICY**

NATIONAL'S PRODUCTS ARE NOT AUTHORIZED FOR USE AS CRITICAL COMPONENTS IN LIFE SUPPORT DEVICES OR SYSTEMS WITHOUT THE EXPRESS WRITTEN APPROVAL OF THE PRESIDENT AND GENERAL COUNSEL OF NATIONAL SEMICONDUCTOR CORPORATION. As used herein:

1. Life support devices or systems are devices or systems which, (a) are intended for surgical implant into the body, or (b) support or sustain life, and whose failure to perform when properly used in accordance with instructions for use provided in the labeling, can be reasonably expected to result in a significant injury to the user.
2. A critical component is any component of a life support device or system whose failure to perform can be reasonably expected to cause the failure of the life support device or system, or to affect its safety or effectiveness.

**BANNED SUBSTANCE COMPLIANCE**

National Semiconductor manufactures products and uses packing materials that meet the provisions of the Customer Products Stewardship Specification (CSP-9-111C2) and the Banned Substances and Materials of Interest Specification (CSP-9-111S2) and contain no "Banned Substances" as defined in CSP-9-111S2.

Leadfree products are RoHS compliant.

**National Semiconductor**  
**Americas Customer Support Center**  
 Email: [new.feedback@nsc.com](mailto:new.feedback@nsc.com)  
 Tel: 1-800-272-9959

**National Semiconductor**  
**Europe Customer Support Center**  
 Fax: +49 (0) 180-530 85 86  
 Email: [europe.support@nsc.com](mailto:europe.support@nsc.com)  
 Deutsch Tel: +49 (0) 69 9508 6208  
 English Tel: +44 (0) 870 24 0 2171  
 Français Tel: +33 (0) 1 41 91 8790

**National Semiconductor**  
**Asia Pacific Customer Support Center**  
 Email: [ap.support@nsc.com](mailto:ap.support@nsc.com)

**National Semiconductor**  
**Japan Customer Support Center**  
 Fax: 81-3-5639-7507  
 Email: [jpn.feedback@nsc.com](mailto:jpn.feedback@nsc.com)  
 Tel: 81-3-5639-7560

[www.national.com](http://www.national.com)