

LM48556 Boomer[®] Audio Power Amplifier Series

Fully Differential, Mono, Ceramic Speaker Driver

General Description

The LM48556 is a single supply, mono, ceramic speaker driver with an integrated charge-pump, designed for portable devices, such as cell phones, where board space is at a premium. The LM48556 charge pump allows the device to deliver 17.5V_{PP} (typ) from a single 4.5V supply. Additionally, the charge pump features a soft start function that minimizes transient current during power-up.

The LM48556 features high power supply rejection ratio (PSRR) of 80dB at 217Hz, allowing the device to operate in noisy environments without additional power supply conditioning. Flexible power supply requirements allow operation from 2.7V to 5.0V. Additionally, the LM48556 features a differential input function and an externally configurable gain. A low power shutdown mode reduces supply current consumption to 0.1μA.

Superior click and pop suppression eliminates audible transients on power-up/down and during shutdown. The LM48556 is available in an ultra-small 12-bump micro SMD package (2mm x 1.5mm).

Key Specifications

- Output Voltage Swing
 - V_{DD} = 3.6V, 1kHz 14.2V_{PP} (typ)
 - V_{DD} = 4.5V, 1kHz 17.5V_{PP} (typ)
- Power Supply Rejection Ratio
 - f = 217Hz, V_{DD} = 3.6V 80dB (typ)
- I_{DD} at V_{DD} = 3.6V 4.8mA (typ)
- Wake-Up Time 0.5ms (typ)

Features

- Fully differential amplifier
- Externally configurable gain
- Integrated charge pump
- Low power shutdown mode
- Soft start function

Applications

- Mobile phones
- PDA's
- Digital cameras

Typical Application

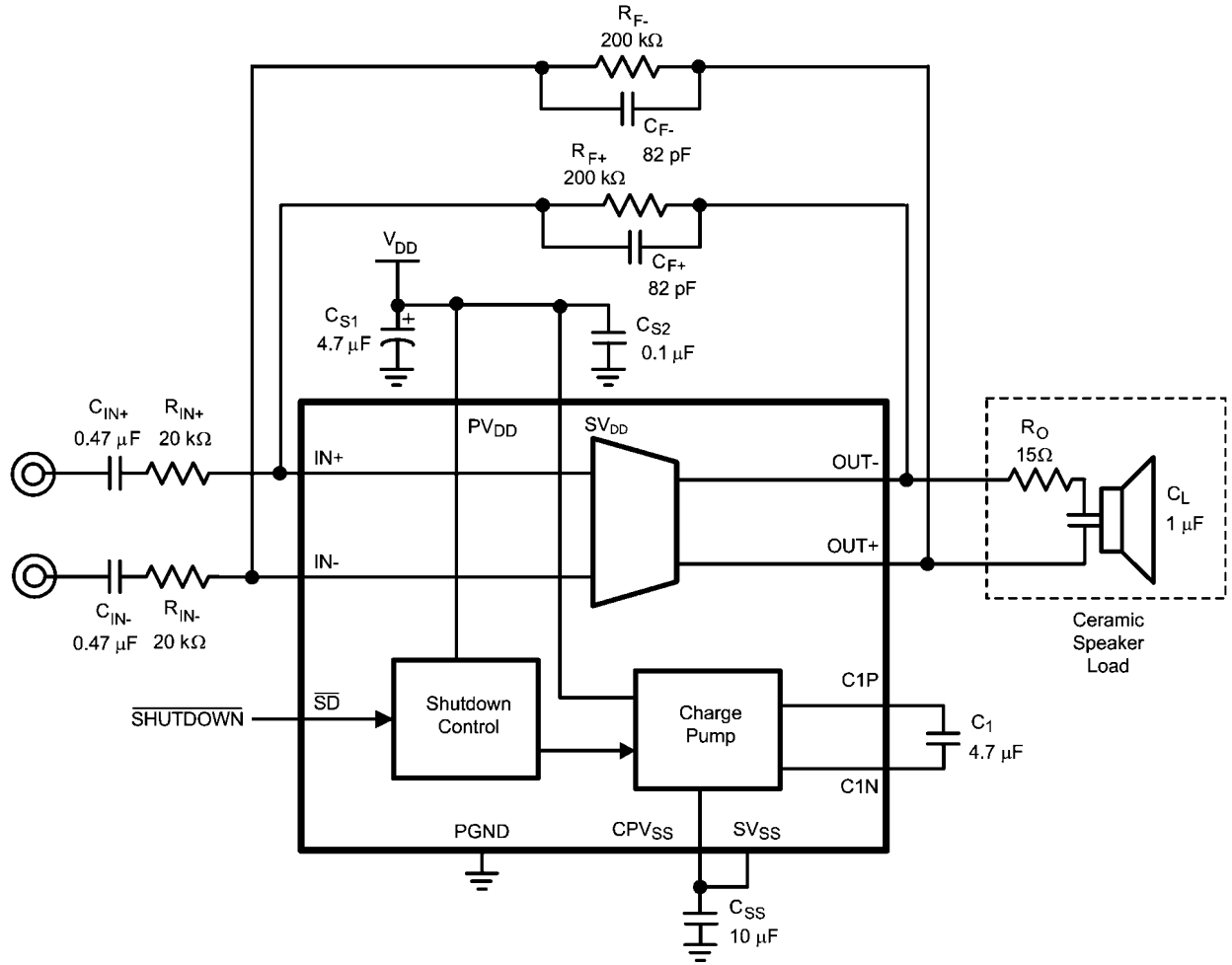

300572d4

FIGURE 1. Typical Audio Amplifier Application Circuit

Connection Diagrams

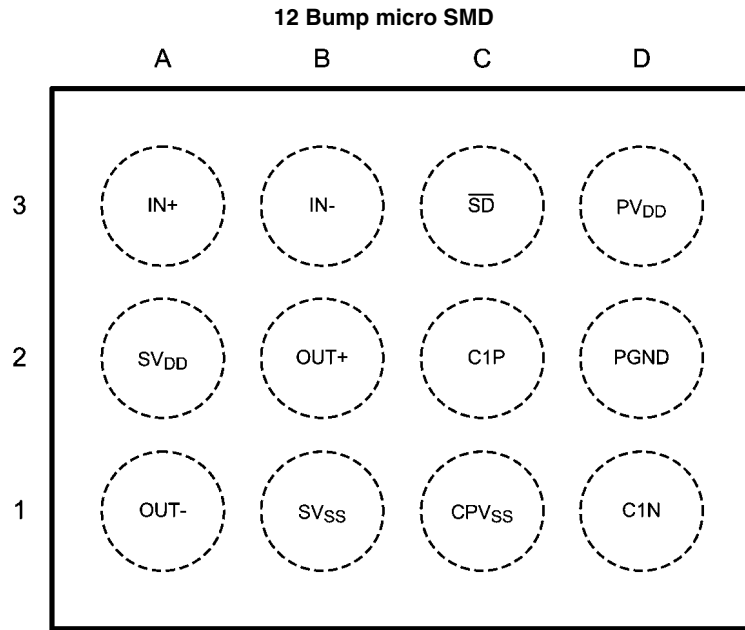

30057266

Top View
 Order Number LM48556TL, LM48556TLX
 See NS Package Number TLA121AA

**12 Bump micro SMD
 Package View**

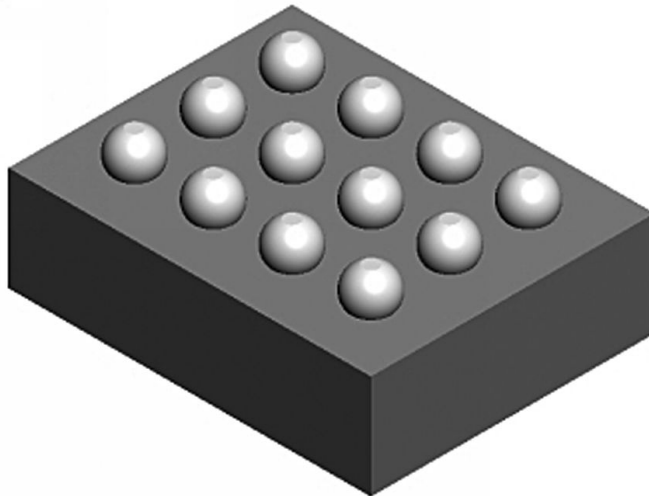

30057231

LM48556TL Marking

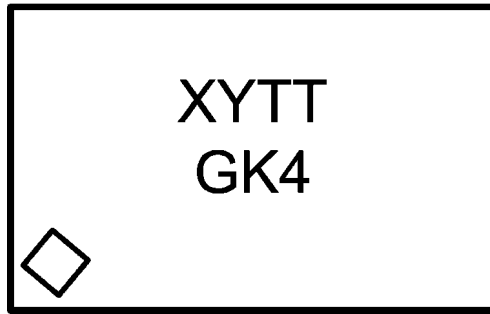

300572d5

Top View
 XY = Date Code
 TT = Lot Traceability
 G = Boomer Family
 K4 = LM48556TL

Bump Descriptions

Bump	Name	Description
A1	OUT-	Amplifier Inverting Output
A2	SV _{DD}	Signal Power Supply - Positive
A3	IN+	Amplifier Non-inverting Input
B1	SV _{SS}	Signal Power Supply - Negative
B2	OUT+	Amplifier Non-inverting Output
B3	IN-	Amplifier Inverting Input
C1	CPV _{SS}	Charge Pump Output Voltage
C2	C1P	Charge Pump Flying Capacitor Positive Terminal
C3	\overline{SD}	Active Low Reset Input. Connect to V _{DD} for normal operation. Drive \overline{SD} low to disable.
D1	C1N	Charge Pump Flying Capacitor Negative Terminal
D2	PGND	Power Ground
D3	PV _{DD}	Power Supply

Ordering Information

Order Number	Package	Package Dwg #	Transport Media	MSL	Green Status	Features
LM48556TL	12 bump micro SMD	TLA121AA	250 units on tape and reel	1	RoHS and no Sb/Br	
LM48556TLX	12 bump micro SMD	TLA121AA	3000 units on tape and reel	1	RoHS and no Sb/Br	

Absolute Maximum Ratings (Notes 1, 2)

If Military/Aerospace specified devices are required, please contact the National Semiconductor Sales Office/Distributors for availability and specifications.

Supply Voltage (SV _{DD} , PV _{DD}) (Note 1)	5.25V
Storage Temperature	-65°C to +150°C
Input Voltage	-0.3V to V _{DD} + 0.3V
Power Dissipation (Note 3)	Internally limited
ESD Rating (Note 4)	2000V
ESD Rating (Note 5)	200V

Junction Temperature	150°C
Thermal Resistance	
θ_{JA} (TL)	114°C/W
Soldering Information	
See AN-1112 Micro SMD Wafer Level Chip Scale	

Operating Ratings

Temperature Range	$T_{MIN} \leq T_A \leq T_{MAX}$	$-40^\circ\text{C} \leq T_A \leq +85^\circ\text{C}$
Supply Voltage (SV _{DD} , PV _{DD})		$2.7\text{V} \leq V_{DD} \leq 5.0\text{V}$

Electrical Characteristics V_{DD} = 3.6V (Note 2)

The following specifications apply for V_{DD} = 3.6V, A_{V-BTL} = 20dB (R_F = 200k Ω , R_{IN} = 20k Ω), Z_L = 15 Ω +1 μ F, unless otherwise specified. Limits apply for T_A = 25°C.

Symbol	Parameter	Conditions	LM48556		Units (Limits)
			Typical (Note 6)	Limit (Note 7)	
I _{DD}	Quiescent Power Supply Current	V _{IN} = 0V	4.8	7	mA (max)
I _{SD}	Shutdown Current	V _{SD} = GND (Note 8)	0.1	1	μ A (max)
V _{OS}	Output Offset Voltage	C _{IN} = 0.47 μ F, A _V = 1V/V (0dB)	0.6	4	mV (max)
T _{WU}	Wake-up Time		0.5		ms
V _{OUT}	Output Voltage Swing	THD+N = 1% (max); f = 1kHz	14.2		V _{PP}
		THD+N = 1% (max); f = 10kHz	11.5	11	V _{PP} (min)
THD+N	Total Harmonic Distortion + Noise	V _{OUT} = 11V _{PP} , f = 1kHz			
		A _V = 0dB	0.005		%
		A _V = 20dB	0.03		%
ϵ_{OS}	Output Noise	A-weighted filter, V _{IN} = 0V Input referred	8		μ V
PSRR	Power Supply Rejection Ratio	V _{RIPPLE} = 200mV _{PP} , f = 217Hz	80	60	dB (min)
CMRR	Common Mode Rejection Ratio	Input Referred	70	60	dB (min)
V _{LH}	Logic High Threshold Voltage			1.2	V (min)
V _{LL}	Logic Low Threshold Voltage			0.45	V (max)

Electrical Characteristics V_{DD} = 4.5V (Note 2)

The following specifications apply for V_{DD} = 4.5V, A_{V-BTL} = 20dB (R_F = 200k Ω , R_{IN} = 20k Ω), Z_L = 15 Ω +1 μ F, unless otherwise specified. Limits apply for T_A = 25°C.

Symbol	Parameter	Conditions	LM48556		Units (Limits)
			Typical (Note 6)	Limit (Note 7)	
I _{DD}	Quiescent Power Supply Current	V _{IN} = 0V	6.5	10	mA (max)
I _{SD}	Shutdown Current	V _{SD} = GND (Note 8)	0.1	1	μ A (max)
V _{OS}	Output Offset Voltage	C _{IN} = 0.47 μ F, A _V = 1V/V (0dB)	0.6	4	mV (max)
T _{WU}	Wake-up Time		0.5		ms (max)
V _{OUT}	Output Voltage Swing	THD+N = 1% (max); f = 1kHz	17.5		V _{PP}
		THD+N = 1% (max); f = 10kHz	14.6	14	V _{PP} (min)
THD+N	Total Harmonic Distortion + Noise	V _{OUT} = 14V _{PP} , f = 1kHz			
		A _V = 0dB	0.005		%
		A _V = 20dB	0.03		%
ϵ_{OS}	Output Noise	A-weighted filter, V _{IN} = 0V Input referred	8		μ V

Symbol	Parameter	Conditions	LM48556		Units (Limits)
			Typical (Note 6)	Limit (Note 7)	
PSRR	Power Supply Rejection Ratio	$V_{\text{RIPPLE}} = 200\text{mV}_{\text{PP}}, f = 217\text{Hz}$,	80	60	dB (min)
CMRR	Common Mode Rejection Ratio	Input Referred	70	60	dB (min)
V_{LH}	Logic High Threshold Voltage			1.2	V (min)
V_{LL}	Logic Low Threshold Voltage			0.45	V (max)

Note 1: "Absolute Maximum Ratings" indicate limits beyond which damage to the device may occur, including inoperability and degradation of device reliability and/or performance. Functional operation of the device and/or non-degradation at the *Absolute Maximum Ratings* or other conditions beyond those indicated in the *Recommended Operating Conditions* is not implied. The *Recommended Operating Conditions* indicate conditions at which the device is functional and the device should not be operated beyond such conditions. All voltages are measured with respect to the ground pin, unless otherwise specified.

Note 2: The *Electrical Characteristics* tables list guaranteed specifications under the listed *Recommended Operating Conditions* except as otherwise modified or specified by the *Electrical Characteristics Conditions* and/or Notes. Typical specifications are estimations only and are not guaranteed.

Note 3: The maximum power dissipation must be derated at elevated temperatures and is dictated by T_{JMAX} , θ_{JA} , and the ambient temperature, T_{A} . The maximum allowable power dissipation is $P_{\text{DMAX}} = (T_{\text{JMAX}} - T_{\text{A}}) / \theta_{\text{JA}}$ or the number given in *Absolute Maximum Ratings*, whichever is lower.

Note 4: Human body model, applicable std. JESD22-A114C.

Note 5: Machine model, applicable std. JESD22-A115-A.

Note 6: Typical values represent most likely parametric norms at $T_{\text{A}} = +25^{\circ}\text{C}$, and at the *Recommended Operation Conditions* at the time of product characterization and are not guaranteed.

Note 7: Datasheet min/max specification limits are guaranteed by test or statistical analysis.

Note 8: Shutdown current is measured in a normal room environment. The $\overline{\text{SD}}$ pin should be driven as close as possible to GND for minimum shutdown current.

Typical Performance Characteristics ($Z_L = 15\Omega + 1\mu F$, $A_V = 20dB$, $BW = 22kHz$)

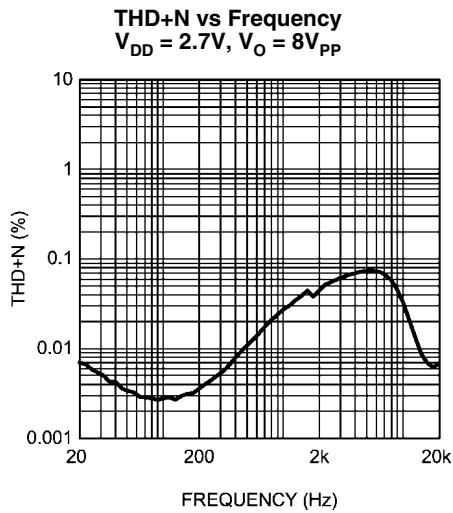

300572e2

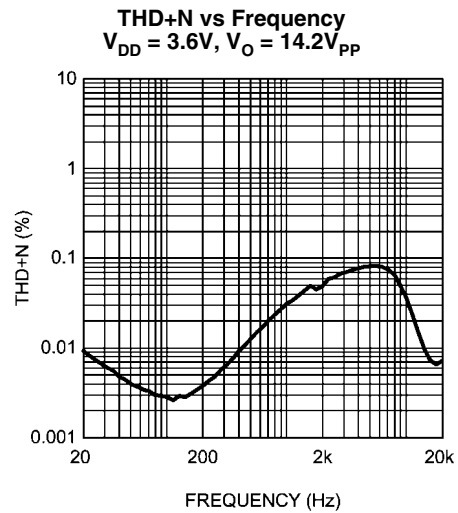

300572e1

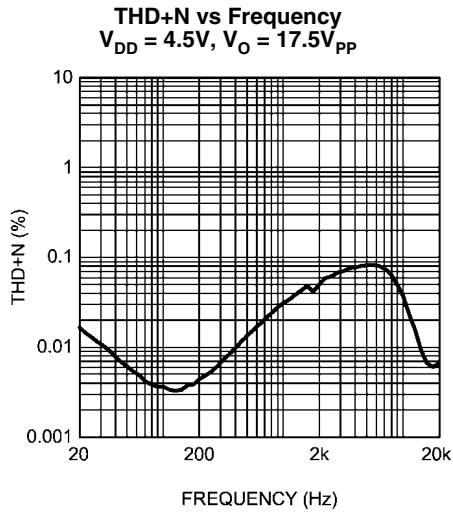

300572d9

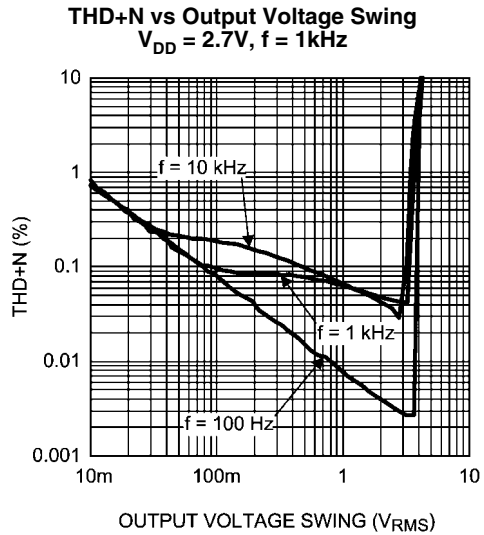

300572d8

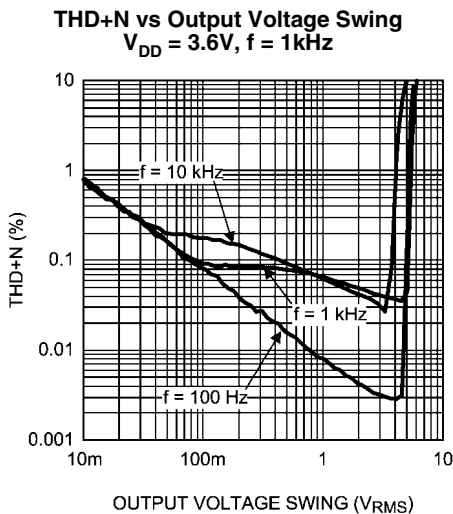

300572d7

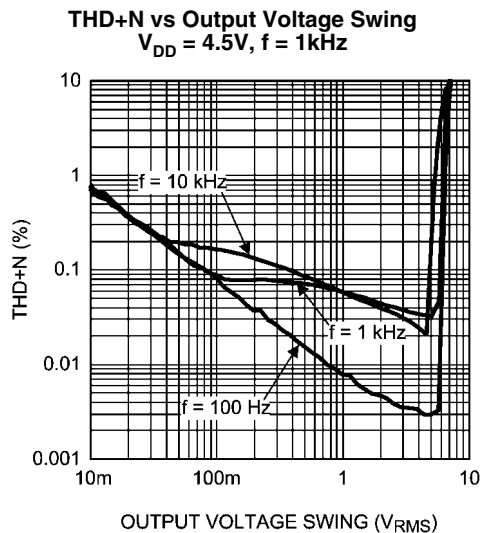

300572e0

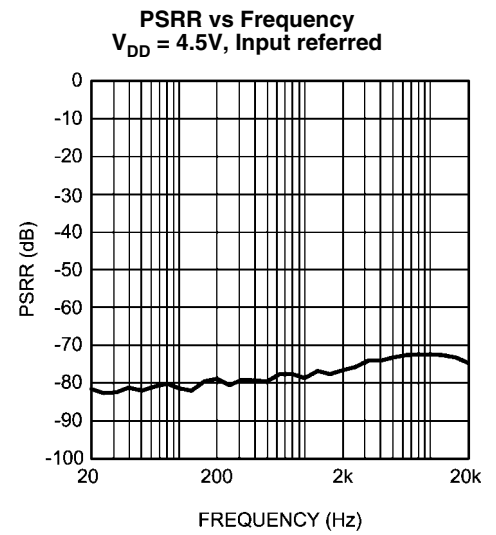
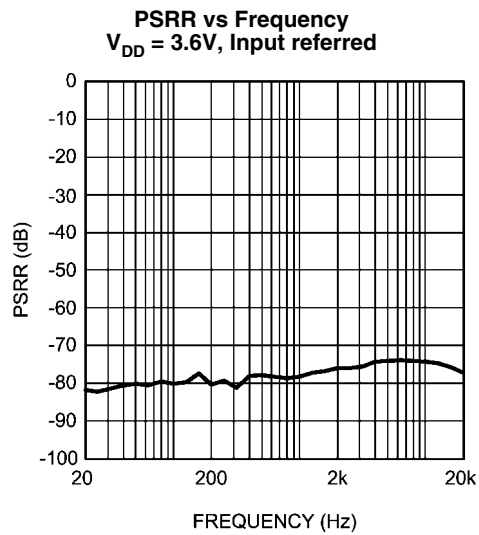
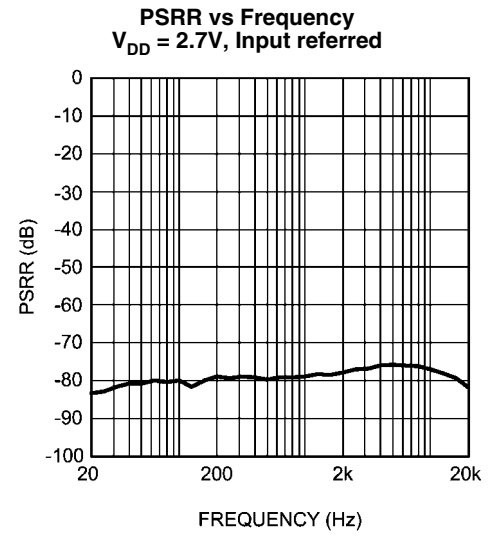
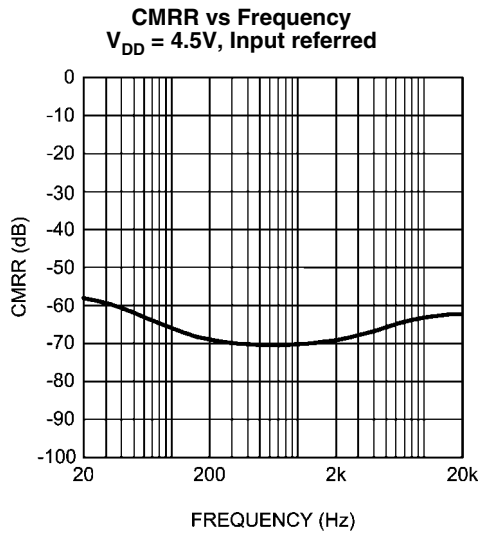
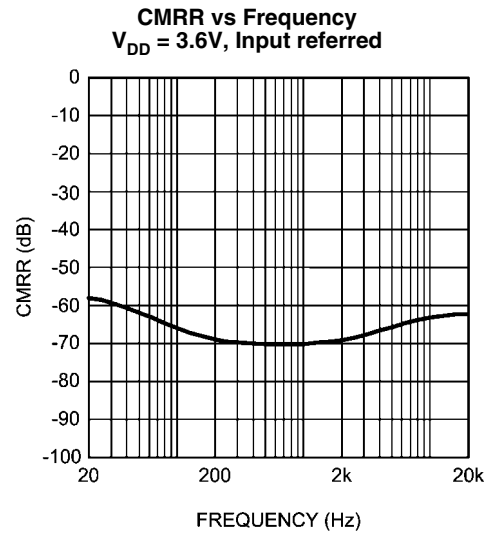
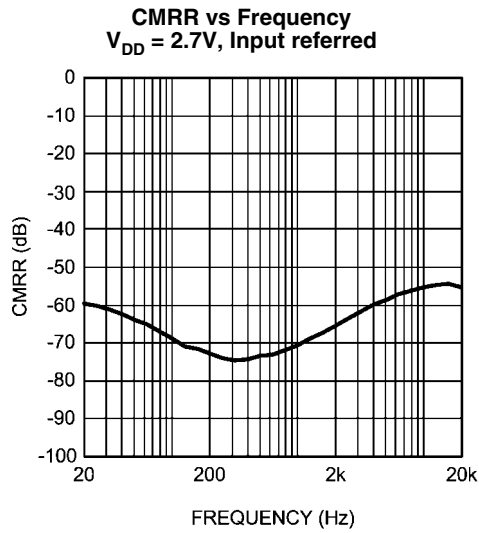

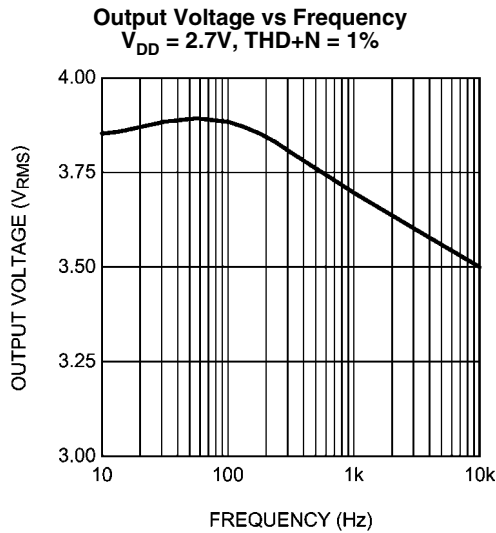

300572e8

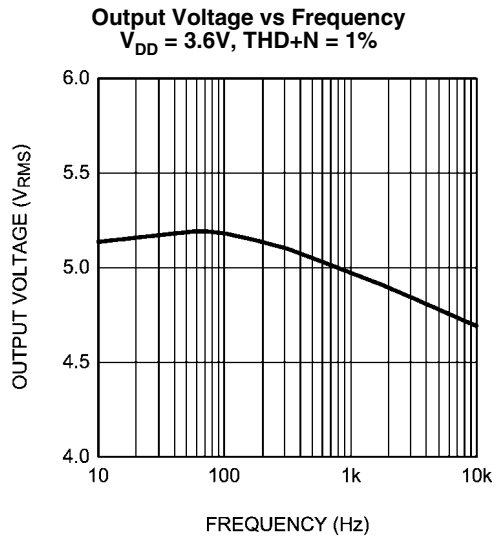

300572e9

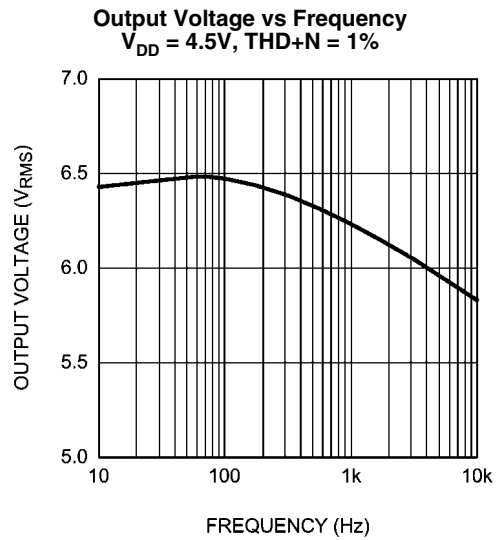

30057210

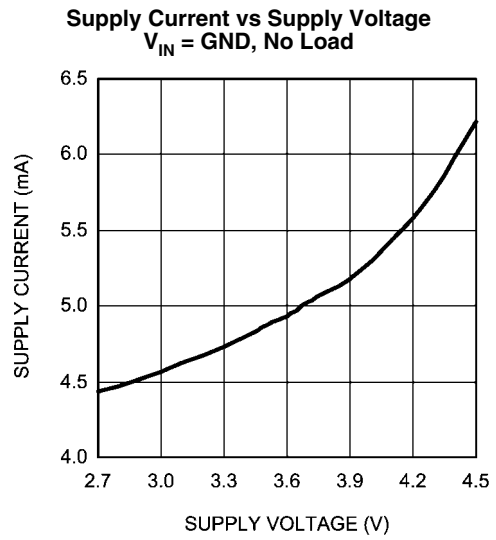

300572e3

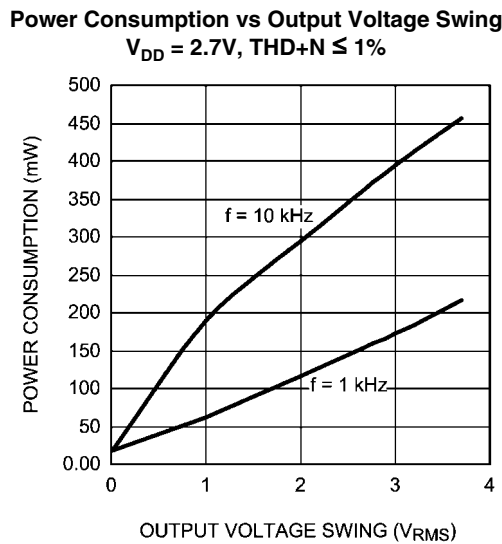

300572e4

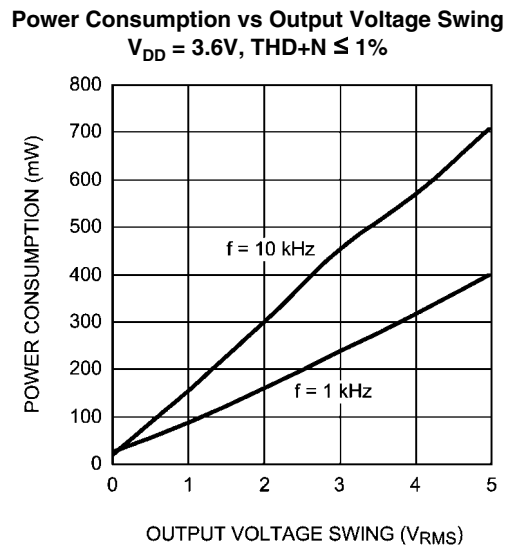

300572e5

Power Consumption vs Output Voltage Swing

$V_{DD} = 4.5V, THD+N \leq 1\%$

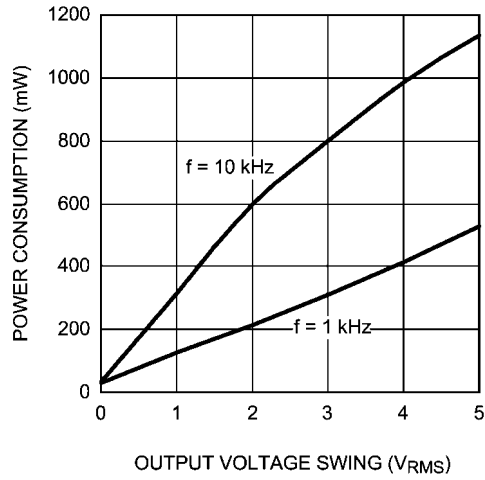

300572e6

Application Information

GENERAL AMPLIFIER FUNCTION

The LM48556 is a fully differential ceramic speaker driver that utilizes National's inverting charge pump technology to deliver the high drive voltages required by ceramic speakers, without the need for noisy, board-space consuming inductive based regulators. The low-noise, inverting charge pump creates a negative supply (CPV_{SS}) from the positive supply (PV_{DD}). Because the amplifiers operate from these bipolar supplies, the maximum output voltage swing for each amplifier is doubled compared to a traditional single supply device. Additionally, the LM48556 is configured as a bridge-tied load (BTL) device, quadrupling the maximum theoretical output voltage range when compared to a single supply, single-ended output amplifier, see *Bridged Configuration Explained* section. The charge pump and BTL configuration allow the LM48556 to deliver over 17V_{P-P} at 1kHz to a 1μF ceramic speaker while operating from a single 4.5V supply.

DIFFERENTIAL AMPLIFIER EXPLANATION

The LM48556 features a differential input stage, which offers improved noise rejection compared to a single-ended input amplifier. Because a differential input amplifier amplifies the difference between the two input signals, any component common to both signals is cancelled. An additional benefit of the differential input structure is the possible elimination of the DC input blocking capacitors. Since the DC component is common to both inputs, and thus cancelled by the amplifier, the LM48556 can be used without input coupling capacitors when configured with a differential input signal.

BRIDGE CONFIGURATION EXPLAINED

The LM48556 is designed to drive a load differentially, a configuration commonly referred to as a bridge-tied load (BTL). The BTL configuration differs from the single-ended configuration, where one side of the load is connected to ground. A BTL amplifier offers advantages over a single-ended device. Driving the load differentially doubles the output voltage compared to a single-ended amplifier under similar conditions. Any component common to both outputs is cancelled, thus there is no net DC voltage across the load, eliminating the DC blocking capacitors required by single-ended, single-supply amplifiers.

SHUTDOWN FUNCTION

The LM48556 features a low current shutdown mode. Set $\overline{SD} = \text{GND}$ to disable the amplifier and reduce supply current to 0.1μA. Switch \overline{SD} between V_{DD} and GND for minimum current consumption in shutdown. The LM48556 may be disabled with shutdown voltages less than 0.45V, however, the idle current will be greater than the typical 0.1μA value.

PROPER SELECTION OF EXTERNAL COMPONENTS

Power Supply Bypassing/Filtering

Proper power supply bypassing is critical for low noise performance and high PSRR. Place the supply bypass capacitors as close to the device as possible. Place a 4.7μF tantalum capacitor in parallel with a 0.1μF ceramic capacitor from V_{DD} to GND. Additional bulk capacitance may be added as required.

Charge Pump Capacitor Selection

Use low ESR ceramic capacitors (less than 100mΩ) for optimum performance.

Charge Pump Flying Capacitor (C1)

The flying capacitor (C1) affects the load regulation and output impedance of the charge pump. A C1 value that is too low results in a loss of current drive, leading to a loss of amplifier headroom. A higher valued C1 improves load regulation and lowers charge pump output impedance to an extent. Above 4.7μF, the R_{DS(ON)} of the charge pump switches and the ESR of C1 and C_{SS} dominate the output impedance. A lower value capacitor can be used in systems with low maximum output power requirements.

Charge Pump Hold Capacitor (C_{SS})

The value and ESR of the hold capacitor (C_{SS}) directly affects the ripple on CPV_{SS}. Increasing the value of C_{SS} reduces output ripple. Decreasing the ESR of C_{SS} reduces both output ripple and charge pump output impedance. A lower value capacitor can be used in systems with low maximum output power requirements.

Gain Setting Resistor Selection

The amplifier gain of the LM48556 is set by four external resistors, two per each input, R_{IN+} and R_{F-} (Figure 1). The amplifier gain is given by equation (1):

$$A_v = R_F / R_{IN} \quad (\text{V/V}) \quad (1)$$

Careful matching of the resistor pairs, R_{F+} and R_{F-}, and R_{IN+} and R_{IN-}, is required for optimum performance. Any mismatch between the resistors results in a differential gain error that leads to an increase in THD+N, decrease in PSRR and CM-RR, as well as an increase in output offset voltage. Resistors with a tolerance of 1% or better are recommended.

The gain setting resistors should be placed as close to the device as possible. Keeping the input traces close together and of the same length increases noise rejection in noisy environments. Noise coupled onto the input traces which are physically close to each other will be common mode and easily rejected.

Feedback Capacitor Selection

Due to their capacitive nature, ceramic speakers poorly reproduce high frequency audio content. At high frequencies, a ceramic speaker presents a low impedance load to the amplifier, increasing the required drive current. The higher output current can drive the device into clipping, increasing THD+N. Low-pass filtering the audio signal improves audio quality by decreasing the signal amplitude at high frequencies, reducing the speaker drive current. Adding a capacitor in parallel with each feedback resistor creates a simple low-pass filter with the -3dB point determined by equation (2):

$$f_{-3dB} = 1 / 2\pi R_F C_F \quad (\text{Hz}) \quad (2)$$

Where R_F is the value of the feedback resistor determined by equation (1) in the *Gain Setting Resistors Selection* section, and C_F is the value of the feedback capacitor. The feedback capacitor is optional and not required for normal operation.

Input Capacitor Selection

Input capacitors block the DC component of the audio signal, eliminating any conflict between the DC component of the audio source and the bias voltage of the LM48556. The input capacitors create a high-pass filter with the input resistors R_{IN}. The -3dB point of the high pass filter is found using Equation (3) below.

$$f = 1 / 2\pi R_{IN} C_{IN} \quad (\text{Hz}) \quad (3)$$

Where the value of R_{IN} is determined by equation (1) in the *Gain Setting Resistor Selection* section.

When the LM48556 is using a single-ended source, power supply noise on the ground is seen as an input signal. Setting the high-pass filter point above the power supply noise fre-

quencies, 217Hz in a GSM phone, for example, filters out the noise such that it is not amplified and heard on the output. Capacitors with a tolerance of 1% or better are recommended for impedance matching and improved CMRR and PSRR.

SINGLE-ENDED AUDIO AMPLIFIER CONFIGURATION

The LM48556 is compatible with single-ended sources. Figure 2 shows the typical single-ended applications circuit. In

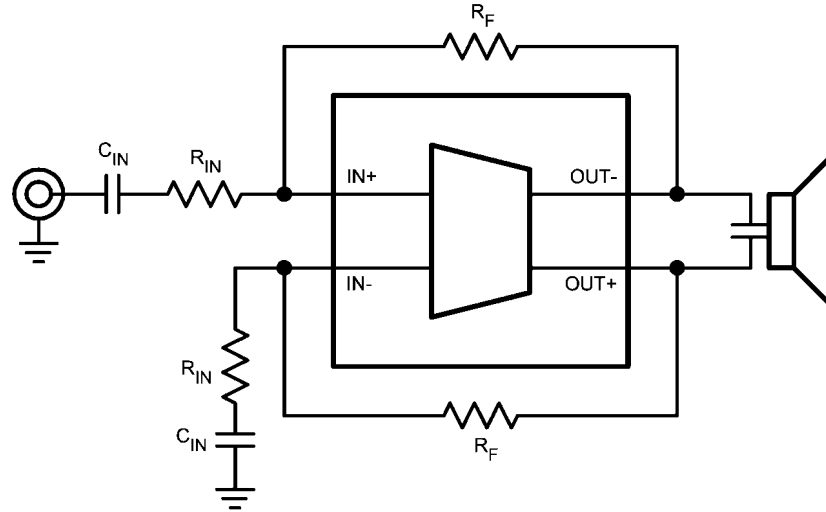

30057286

FIGURE 2. Single-Ended Input Configuration

Bill Of Materials

Component	Description	Designator	Footprint	Quantity
LM48556TL	LM48556TL	LM48556TL	LM48556TL	1
Capacitor	4.7 μ F, ceramic, low ESR (<0.1 Ω) 16V, -40°C to +85°C	C1	CR3216-1206	1
Capacitor	82 μ F, 16V, -40°C to +85°C	C _{F+}	CR2012-0805	1
Capacitor	82 μ F, 16V, -40°C to +85°C	C _{F-}	CR2012-0805	1
Capacitor	0.47 μ F, 16V, -40°C to +85°C	C _{IN+}	CR2012-0805	1
Capacitor	0.47 μ F, 16V, -40°C to +85°C	C _{IN-}	CR2012-0805	1
Capacitor	4.7 μ F, 16V, -40°C to +85°C	C _{S1}	CR3216-1206	1
Capacitor	0.1 μ F ceramic, 16V, -40°C to +85°C	C _{S2}	CR2012-0805	1
Capacitor	10 μ F ceramic, low ESR (<0.1 Ω) 16V, -40°C to +85°C	C _{SS}	CR3216-1206	1
Header, 2-Pin	Header 2	IN	HDR1X2	1
Resistor	200k Ω	R _{F+}	CR2012-0805	1
Resistor	200k Ω	R _{F+}	CR2012-0805	1
Resistor	200k Ω	R _{IN+}	CR2012-0805	1
Resistor	200k Ω	R _{IN-}	CR2012-0805	1
Header, 2-Pin	Header 2	SPEAKER	HDR1X2	1
Header, 2-Pin	Header 2	V _{DD}	HDR1X2	1
Header, 3-Pin	3-pole jumper	J1	3-pole jumper	1

Demonstration Board Schematic

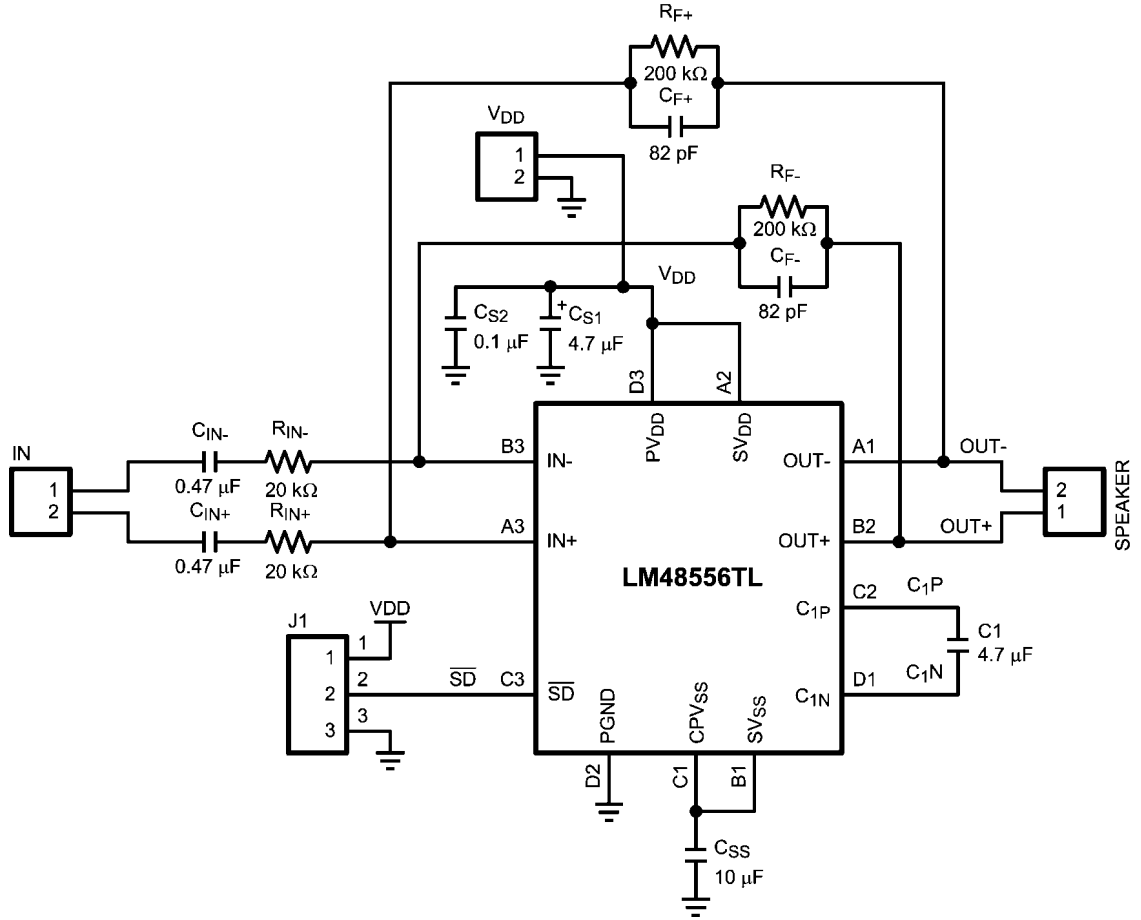

FIGURE 3: Demo Board Schematic

300572b0

Demonstration Board PCB Views

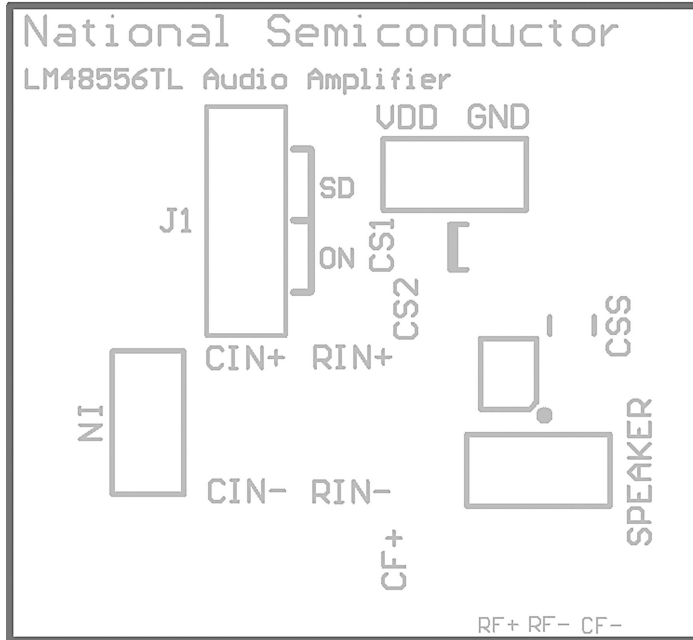

FIGURE 4: Top Overlay

300572b6

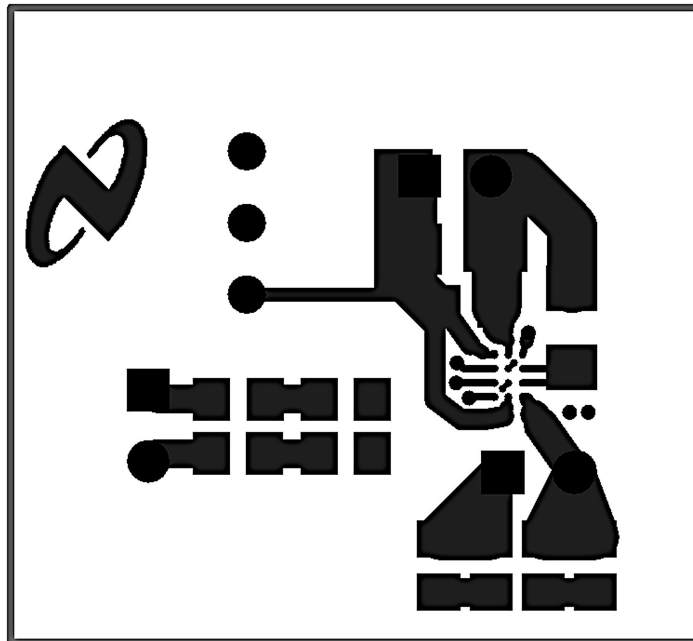

FIGURE 5: Top Layer

300572b5

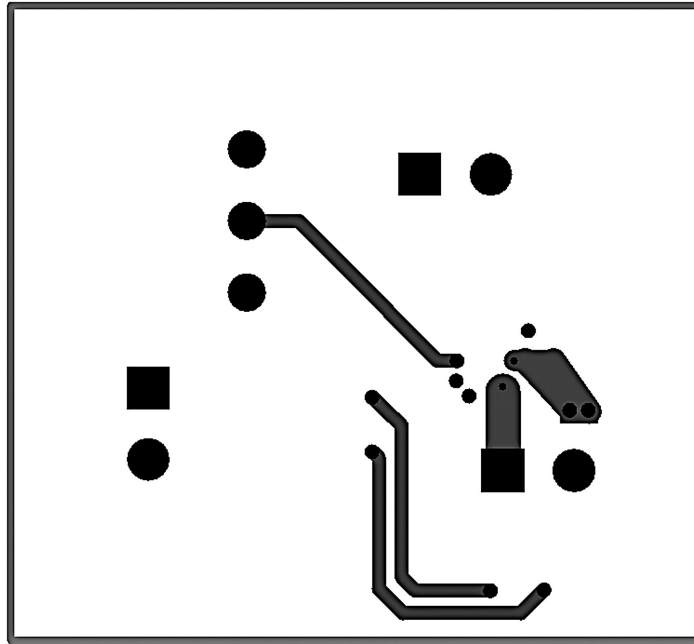

FIGURE 6: Mid Layer 1

300572b3

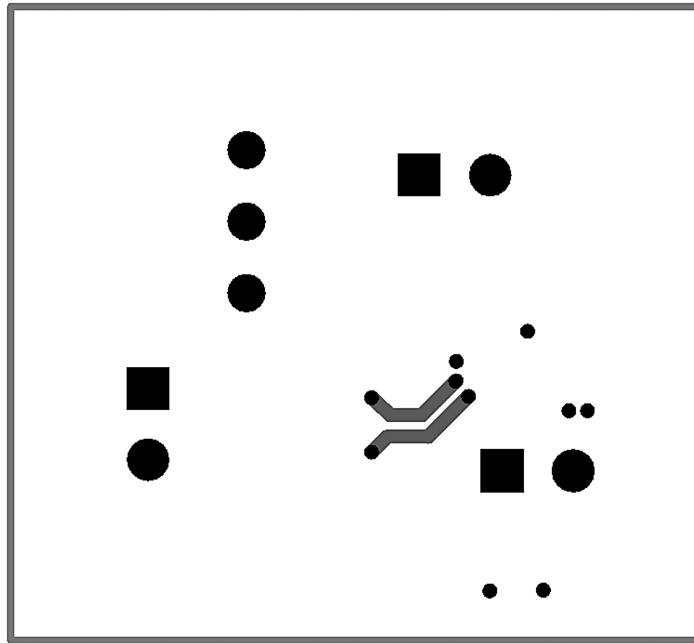

FIGURE 7: Mid Layer 2

300572b4

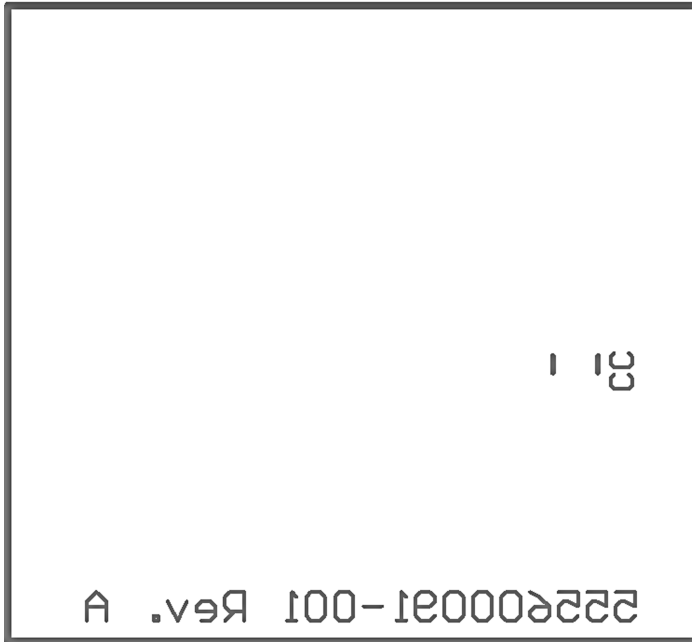

FIGURE 8: Bottom Overlay

300572b2

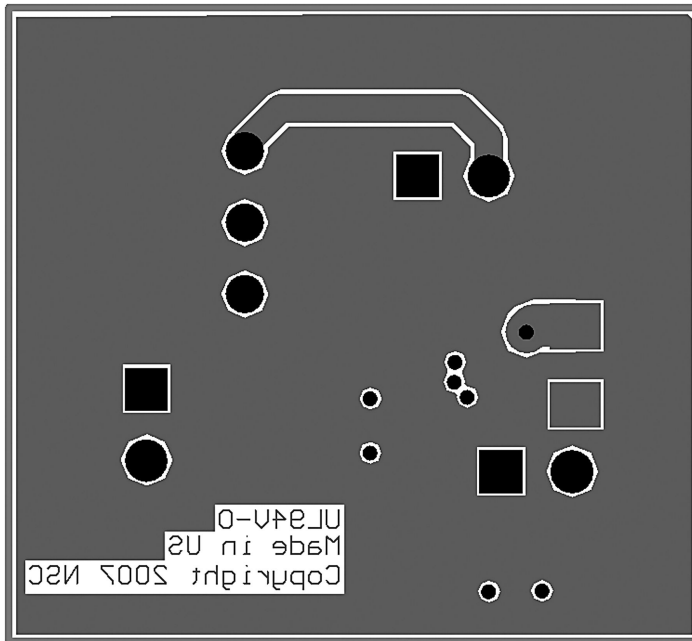

FIGURE 9: Bottom Layer

300572b1

Revision History

Rev	Date	Description
1.0	06/03/08	Initial release.
1.01	12/09/08	Changed Power Supply Voltage Limits from 4.5V to 5.0V.

Physical Dimensions inches (millimeters) unless otherwise noted

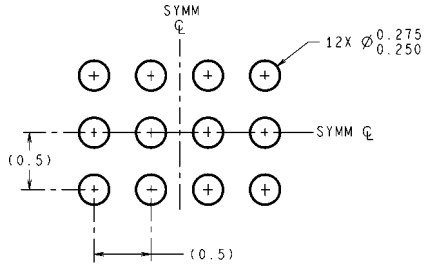

DIMENSIONS ARE IN MILLIMETERS
DIMENSIONS IN () FOR REFERENCE ONLY

LAND PATTERN RECOMMENDATION

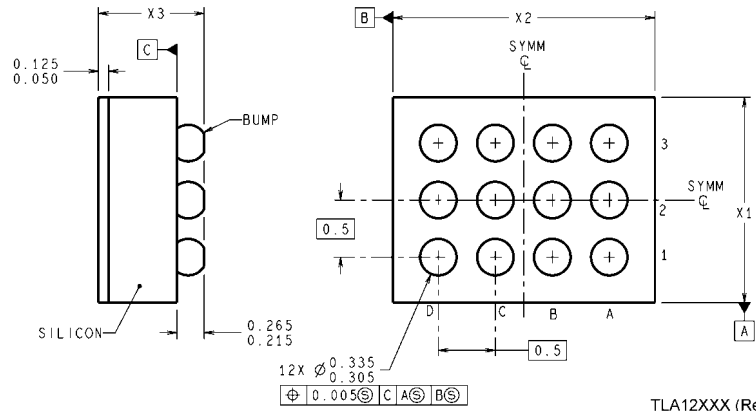
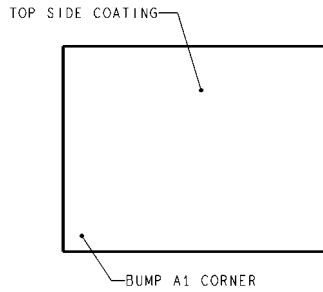

TLA12XXX (Rev C)

12 Bump micro SMD
Order Number LM48556TL, LM48556TLX
NS Package Number TLA121AA
X₁ = 1488μm, X₂ = 1996μm, X₃ = 600μm

Notes

For more National Semiconductor product information and proven design tools, visit the following Web sites at:

Products		Design Support	
Amplifiers	www.national.com/amplifiers	WEBENCH® Tools	www.national.com/webench
Audio	www.national.com/audio	App Notes	www.national.com/appnotes
Clock and Timing	www.national.com/timing	Reference Designs	www.national.com/refdesigns
Data Converters	www.national.com/adc	Samples	www.national.com/samples
Interface	www.national.com/interface	Eval Boards	www.national.com/evalboards
LVDS	www.national.com/lvds	Packaging	www.national.com/packaging
Power Management	www.national.com/power	Green Compliance	www.national.com/quality/green
Switching Regulators	www.national.com/switchers	Distributors	www.national.com/contacts
LDOs	www.national.com/ldo	Quality and Reliability	www.national.com/quality
LED Lighting	www.national.com/led	Feedback/Support	www.national.com/feedback
Voltage Reference	www.national.com/vref	Design Made Easy	www.national.com/easy
PowerWise® Solutions	www.national.com/powerwise	Solutions	www.national.com/solutions
Serial Digital Interface (SDI)	www.national.com/sdi	Mil/Aero	www.national.com/milaero
Temperature Sensors	www.national.com/tempsensors	Solar Magic®	www.national.com/solarmagic
Wireless (PLL/VCO)	www.national.com/wireless	Analog University®	www.national.com/AU

THE CONTENTS OF THIS DOCUMENT ARE PROVIDED IN CONNECTION WITH NATIONAL SEMICONDUCTOR CORPORATION ("NATIONAL") PRODUCTS. NATIONAL MAKES NO REPRESENTATIONS OR WARRANTIES WITH RESPECT TO THE ACCURACY OR COMPLETENESS OF THE CONTENTS OF THIS PUBLICATION AND RESERVES THE RIGHT TO MAKE CHANGES TO SPECIFICATIONS AND PRODUCT DESCRIPTIONS AT ANY TIME WITHOUT NOTICE. NO LICENSE, WHETHER EXPRESS, IMPLIED, ARISING BY ESTOPPEL OR OTHERWISE, TO ANY INTELLECTUAL PROPERTY RIGHTS IS GRANTED BY THIS DOCUMENT.

TESTING AND OTHER QUALITY CONTROLS ARE USED TO THE EXTENT NATIONAL DEEMS NECESSARY TO SUPPORT NATIONAL'S PRODUCT WARRANTY. EXCEPT WHERE MANDATED BY GOVERNMENT REQUIREMENTS, TESTING OF ALL PARAMETERS OF EACH PRODUCT IS NOT NECESSARILY PERFORMED. NATIONAL ASSUMES NO LIABILITY FOR APPLICATIONS ASSISTANCE OR BUYER PRODUCT DESIGN. BUYERS ARE RESPONSIBLE FOR THEIR PRODUCTS AND APPLICATIONS USING NATIONAL COMPONENTS. PRIOR TO USING OR DISTRIBUTING ANY PRODUCTS THAT INCLUDE NATIONAL COMPONENTS, BUYERS SHOULD PROVIDE ADEQUATE DESIGN, TESTING AND OPERATING SAFEGUARDS.

EXCEPT AS PROVIDED IN NATIONAL'S TERMS AND CONDITIONS OF SALE FOR SUCH PRODUCTS, NATIONAL ASSUMES NO LIABILITY WHATSOEVER, AND NATIONAL DISCLAIMS ANY EXPRESS OR IMPLIED WARRANTY RELATING TO THE SALE AND/OR USE OF NATIONAL PRODUCTS INCLUDING LIABILITY OR WARRANTIES RELATING TO FITNESS FOR A PARTICULAR PURPOSE, MERCHANTABILITY, OR INFRINGEMENT OF ANY PATENT, COPYRIGHT OR OTHER INTELLECTUAL PROPERTY RIGHT.

LIFE SUPPORT POLICY

NATIONAL'S PRODUCTS ARE NOT AUTHORIZED FOR USE AS CRITICAL COMPONENTS IN LIFE SUPPORT DEVICES OR SYSTEMS WITHOUT THE EXPRESS PRIOR WRITTEN APPROVAL OF THE CHIEF EXECUTIVE OFFICER AND GENERAL COUNSEL OF NATIONAL SEMICONDUCTOR CORPORATION. As used herein:

Life support devices or systems are devices which (a) are intended for surgical implant into the body, or (b) support or sustain life and whose failure to perform when properly used in accordance with instructions for use provided in the labeling can be reasonably expected to result in a significant injury to the user. A critical component is any component in a life support device or system whose failure to perform can be reasonably expected to cause the failure of the life support device or system or to affect its safety or effectiveness.

National Semiconductor and the National Semiconductor logo are registered trademarks of National Semiconductor Corporation. All other brand or product names may be trademarks or registered trademarks of their respective holders.

Copyright© 2008 National Semiconductor Corporation

For the most current product information visit us at www.national.com



National Semiconductor Americas Technical Support Center
 Email: support@nsc.com
 Tel: 1-800-272-9959

National Semiconductor Europe Technical Support Center
 Email: europe.support@nsc.com
 German Tel: +49 (0) 180 5010 771
 English Tel: +44 (0) 870 850 4288

National Semiconductor Asia Pacific Technical Support Center
 Email: ap.support@nsc.com

National Semiconductor Japan Technical Support Center
 Email: jpn.feedback@nsc.com