

LM48410 Boomer® Audio Power Amplifier Series

Low EMI, Filterless, 2.3W Stereo Class D Audio Power Amplifier with National 3D Enhancement

General Description

The LM48410 is a single supply, high efficiency, 2.3W/channel, filterless switching audio amplifier. A low noise PWM architecture eliminates the output filter, reducing external component count, board area consumption, system cost, and simplifying design. A selectable spread spectrum modulation scheme suppresses RF emissions, further reducing the need for output filters.

The LM48410 is designed to meet the demands of mobile phones and other portable communication devices. Operating from a single 5V supply, the device is capable of delivering 2.3W/channel of continuous output power to a 4Ω load with less than 10% THD+N. Flexible power supply requirements allow operation from 2.4V to 5.5V. The LM48410 offers two logic selectable modulation schemes, fixed frequency mode, and an EMI reducing spread spectrum mode.

The LM48410 features high efficiency compared with conventional Class AB amplifiers. When driving an 8Ω speaker from a 3.6V supply, the device operates with 85% efficiency at $P_O = 500\text{mW/Ch}$. Four gain options are pin selectable through the G0 and G1 pins. The LM48410 also includes National's 3D audio enhancement that improves stereo sound quality. In devices where the left and right speakers are in close proximity, 3D enhancement affects channel specialization, widening the perceived soundstage.

Output short circuit protection prevents the device from being damaged during fault conditions. Superior click and pop suppression eliminates audible transients on power-up/down and during shutdown. Independent left/right shutdown controls maximizes power savings in mixed mono/stereo applications.

Key Specifications

■ Quiescent Power Supply Current at 3.6V supply	4mA
■ Power Output at $V_{DD} = 5\text{V}$, $R_L = 4\Omega$, THD $\leq 10\%$	2.3W (typ)
■ Power Output at $V_{DD} = 5\text{V}$, $R_L = 8\Omega$, THD $\leq 10\%$	1.5W (typ)
■ Shutdown current	0.03μA (typ)
■ Efficiency at 3.6V, 100mW into 8Ω	80% (typ)
■ Efficiency at 3.6V, 500mW into 8Ω	85% (typ)
■ Efficiency at 5V, 1W into 8Ω	86% (typ)

Features

- Selectable spread spectrum mode reduces EMI
- Output Short Circuit Protection
- Stereo Class D operation
- No output filter required
- National 3D Enhancement
- Logic selectable gain
- Independent channel shutdown controls
- Minimum external components
- Click and Pop suppression
- Micro-power shutdown
- Available in space-saving 4mm x 4mm LLP package

Applications

- Mobile phones
- PDAs
- Laptops

EMI Plot

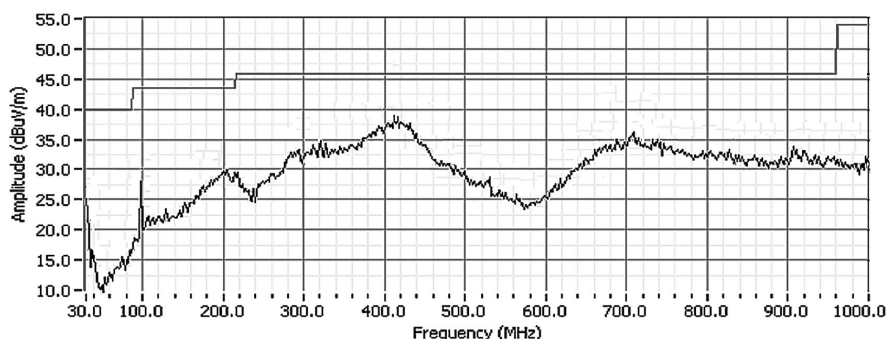

300106a0

Boomer® is a registered trademark of National Semiconductor Corporation.

Typical Application

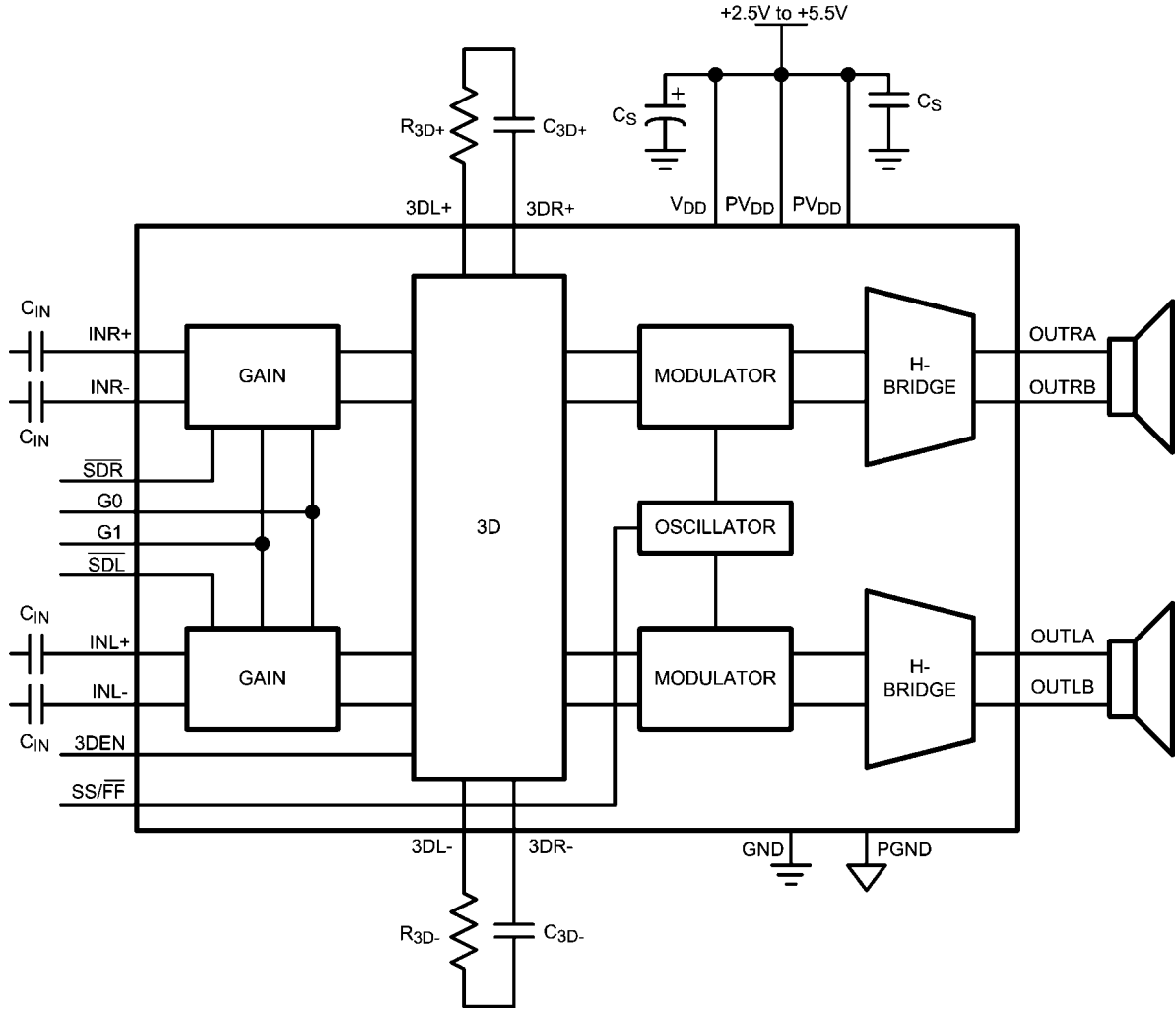

30010686

FIGURE 1. Typical Audio Amplifier Application Circuit

Connection Diagrams

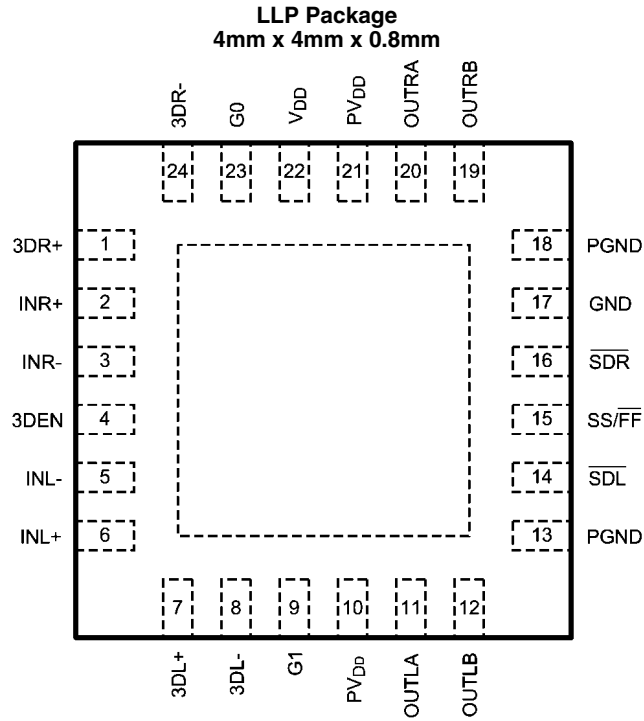

Top View
Order Number LM48410SQ
See NS Package Number SQA24A

LM48410SQ Markings

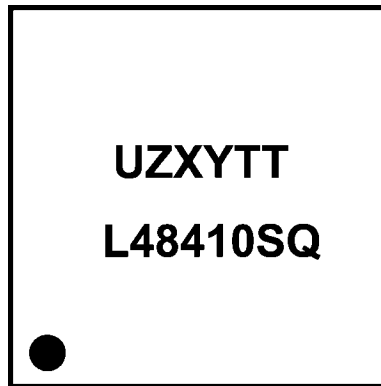

30010699

Top View
U = Wafer Fab Code
Z = Assembly Plant
XY = 2 Digit Date Code
TT = Lot Traceability
L48410SQ = LM48410SQ

Pin Descriptions

Pin	Name	Description
1	3DR+	Right Channel non-inverting 3D connection. Connect to 3DL+ through C _{3D+} and R _{3D+} .
2	INR+	Right Channel Non-Inverting Input
3	INR-	Right Channel Inverting Input
4	3DEN	3D Enable Input
5	INL-	Left Channel Inverting Input
6	INL+	Left Channel Non-Inverting Input
7	3DL+	Left Channel non-inverting 3D connection. Connect to 3DR+ through C _{3D+} and R _{3D+} .
8	3DL-	Left Channel inverting 3D connection. Connect to 3DR- through C _{3D-} and R _{3D-} .
9	G1	Gain Select Input 1
10, 21	PV _{DD}	Speaker Power Supply
11	OUTLA	Left Channel Non-Inverting Output
12	OUTLB	Left Channel Inverting Output
13, 18	PGND	Power Ground
14	$\overline{\text{SDL}}$	Left Channel Active Low Shutdown. Connect to V _{DD} for normal operation. Connect to GND to disable the left channel.
15	SS/ $\overline{\text{FF}}$	Modulation Mode Select. Connect to V _{DD} for spread spectrum mode. Connect to GND for fixed frequency mode
16	$\overline{\text{SDR}}$	Right Channel Active Low Shutdown. Connect to V _{DD} for normal operation. Connect to GND to disable the right channel.
17	GND	Ground
19	OUTRB	Right Channel Inverting Output
20	OUTRA	Right Channel Non-Inverting Output
22	V _{DD}	Power Supply
23	G0	Gain Select Input 0
24	3DR-	Right Channel inverting 3D connection. Connect to 3DL- through C _{3D-} and R _{3D-} .

Absolute Maximum Ratings (Notes 1, 2)

If Military/Aerospace specified devices are required, please contact the National Semiconductor Sales Office/Distributors for availability and specifications.

Supply Voltage (Note 1)	6.0V
Storage Temperature	-65°C to +150°C
Input Voltage	-0.3V to $V_{DD} + 0.3V$
Power Dissipation (Note 3)	Internally Limited
ESD Susceptibility (Note 4)	2000V
ESD Susceptibility (Note 5)	200V

Junction Temperature	150°C
Thermal Resistance	
θ_{JC} (TBD)	5.3°C/W
θ_{JA} (TBD)	36.5°C/W

Operating Ratings (Notes 1, 2)

Temperature Range	
$T_{MIN} \leq T_A \leq T_{MAX}$	-40°C $\leq T_A \leq$ 85°C
Supply Voltage (V_{DD} , PV_{DD})	2.4V $\leq V_{DD} \leq$ 5.5V

Electrical Characteristics $V_{DD} = PV_{DD} = 3.6V$ (Notes 1, 2) The following specifications apply for $A_V = 6dB$, $R_L = 15\mu H + 8\Omega + 15\mu H$, $SS/FF = V_{DD}$ (Spread Spectrum mode), $f = 1kHz$, unless otherwise specified. Limits apply for $T_A = 25^\circ C$.

Symbol	Parameter	Conditions	LM48410		Units (Limits)
			Typical	Limit	
			(Note 6)	(Notes 7, 8)	
V_{OS}	Differential Output Offset Voltage	$V_{IN} = 0$, $V_{DD} = 2.4V$ to $5.0V$	5		mV
I_{DD}	Quiescent Power Supply Current	$V_{IN} = 0$, No Load	4	6.5	mA (max)
		Both channels active, $V_{DD} = 3.6V$ $V_{DD} = 5V$	5	8.5	mA (max)
I_{SD}	Shutdown Current	$V_{SDL} = V_{SDR} = GND$	0.03	1	μA (max)
V_{IH}	Logic Input High Voltage			1.4	V (min)
V_{IL}	Logic Input Low Voltage			0.4	V (max)
T_{WU}	Wake Up Time		4		ms
f_{SW}	Switching Frequency	$SS/FF = V_{DD}$ (Spread Spectrum)	300	390	kHz (max)
		$SS/FF = GND$ (Fixed Frequency)	300		kHz
A_V	Gain	$G0, G1 = GND$ $R_L = \infty$	6	5.5 6.5	dB (min) dB (max)
		$G0 = V_{DD}$, $G1 = GND$	12	11.5 12.5	dB (min) dB (max)
		$G0 = GND$, $G1 = V_{DD}$	18	17.5 18.5	dB (min) dB (max)
		$G0, G1 = V_{DD}$	24	23.5 24.5	dB (min) dB (max)
R_{IN}	Input Resistance	$A_V = 6dB$	160		$k\Omega$
		$A_V = 12dB$	80		$k\Omega$
		$A_V = 18dB$	40		$k\Omega$
		$A_V = 24dB$	20		$k\Omega$

Symbol	Parameter	Conditions	LM48410		Units (Limits)
			Typical	Limit	
			(Note 6)	(Notes 7, 8)	
P _O	Output Power (Per Channel)	R _L = 15μH + 4Ω + 15μH, THD ≤ 10% f = 1kHz, 22kHz BW			
		V _{DD} = 5V	2.3		W
		V _{DD} = 3.6V	1.14		W
		V _{DD} = 2.5V	490		mW
		R _L = 15μH + 8Ω + 15μH, THD ≤ 10% f = 1kHz, 22kHz BW			
		V _{DD} = 5V	1.5		W
		V _{DD} = 3.6V	740	600	mW (min)
		V _{DD} = 2.5V	330		mW
		R _L = 15μH + 4Ω + 15μH, THD ≤ 1% f = 1kHz, 22kHz BW			
		V _{DD} = 5V	1.85		W
		V _{DD} = 3.6V	940		mW
		V _{DD} = 2.5V	400		mW
		R _L = 15μH + 8Ω + 15μH, THD = 1% f = 1kHz, 22kHz BW			
		V _{DD} = 5V	1.18		W
		V _{DD} = 3.6V	580		mW
V _{DD} = 2.5V	270		mW		
THD+N	Total Harmonic Distortion	P _O = 500mW/Ch, f = 1kHz, R _L = 8Ω	0.025		%
		P _O = 300mW/Ch, f = 1kHz, R _L = 8Ω	0.07		%
PSRR	Power Supply Rejection Ratio	V _{RIPPLE} = 200mV _{P-P} Sine, Inputs AC GND, C _{IN} = 1μF, input referred f _{Ripple} = 217Hz	70		dB
		f _{Ripple} = 1kHz,	68		dB
CMRR	Common Mode Rejection Ratio	V _{RIPPLE} = 1V _{P-P} f _{RIPPLE} = 217Hz	65		dB
η	Efficiency	P _O = 1W/Ch, f = 1kHz, R _L = 8Ω, V _{DD} = 5V	86		%
Xtalk	Crosstalk	P _O = 500mW/Ch, f = 1kHz	82		dB
SNR	Signal to Noise Ratio	V _{DD} = 5V, P _O = 1W Fixed Frequency Mode	88		dB
ε _{OS}	Output Noise	Input referred, Fixed Frequency Mode A-Weighted Filter	28		μV

Note 1: All voltages are measured with respect to the ground pin, unless otherwise specified.

Note 2: *Absolute Maximum Ratings* indicate limits beyond which damage to the device may occur. *Operating Ratings* indicate conditions for which the device is functional, but do not guarantee specific performance limits. *Electrical Characteristics* state DC and AC electrical specifications under particular test conditions which guarantee specific performance limits. This assumes that the device is within the Operating Ratings. Specifications are not guaranteed for parameters where no limit is given, however, the typical value is a good indication of device performance.

Note 3: The maximum power dissipation must be derated at elevated temperatures and is dictated by T_{JMAX} , θ_{JA} , and the ambient temperature, T_A . The maximum allowable power dissipation is $P_{DMAX} = (T_{JMAX} - T_A) / \theta_{JA}$ or the number given in Absolute Maximum Ratings, whichever is lower.

Note 4: Human body model, 100pF discharged through a 1.5k Ω resistor.

Note 5: Machine Model, 220pF–240pF discharged through all pins.

Note 6: Typicals are measured at 25°C and represent the parametric norm.

Note 7: Limits are guaranteed to National's AOQL (Average Outgoing Quality Level).

Note 8: Datasheet min/max specification limits are guaranteed by design, test, or statistical analysis.

Typical Performance Characteristics

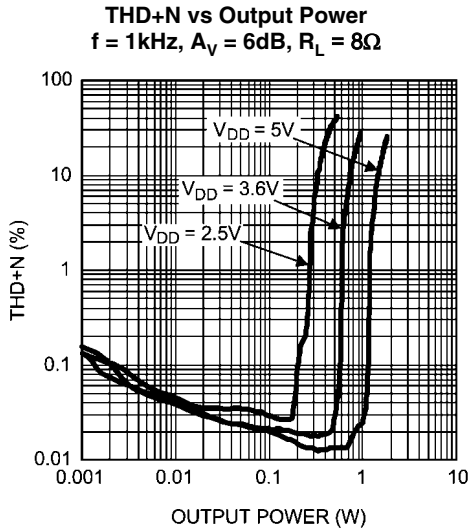

30010667

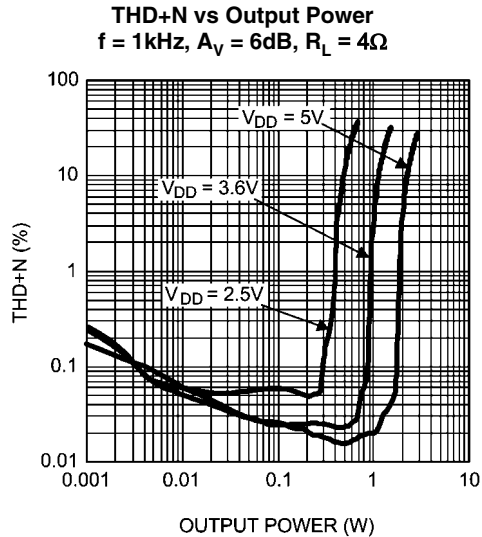

30010668

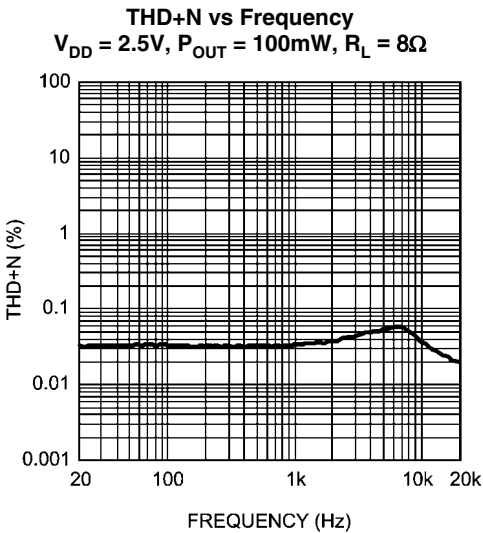

30010688

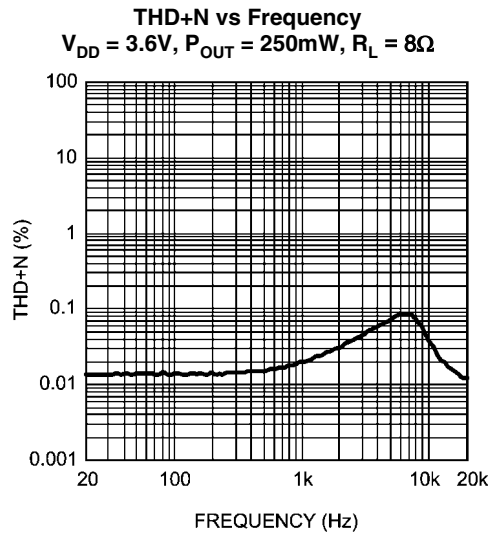

30010689

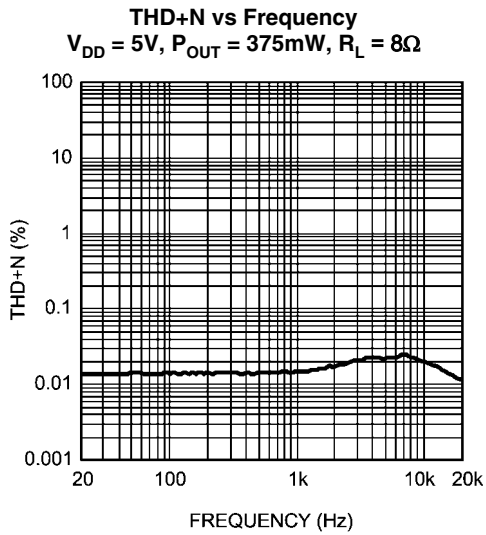

30010690

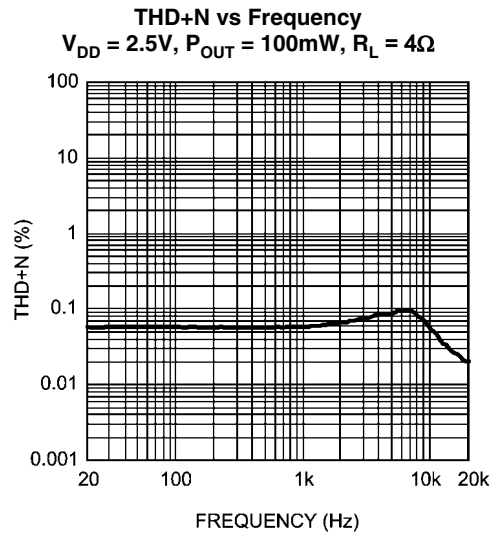

30010691

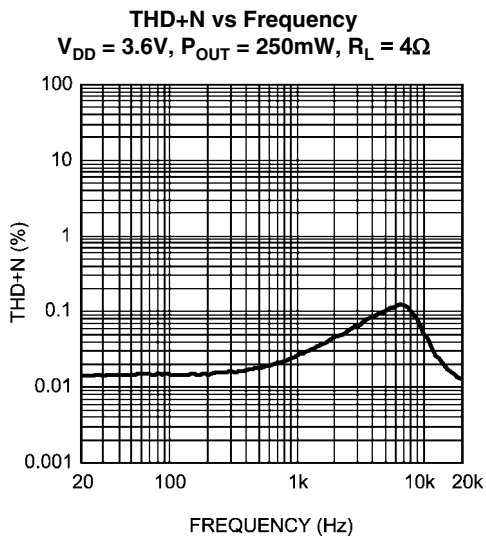

30010692

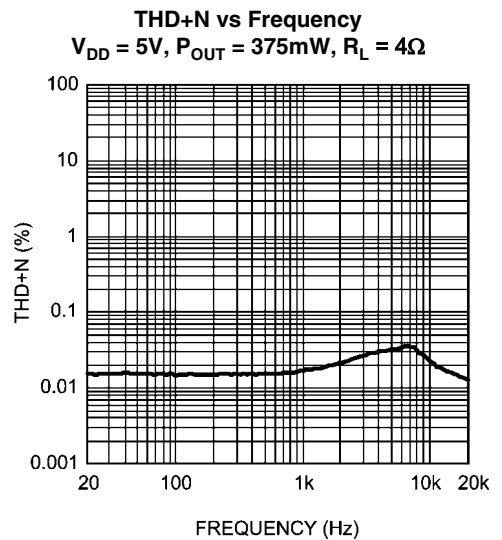

30010693

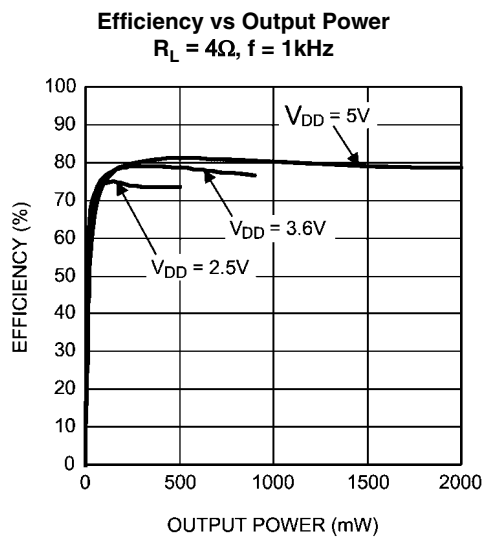

30010675

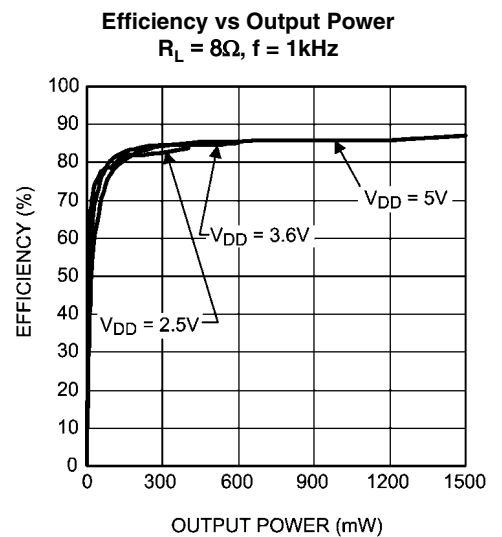

30010676

Power Dissipation vs Output Power
 $R_L = 4\Omega, f = 1\text{kHz}$

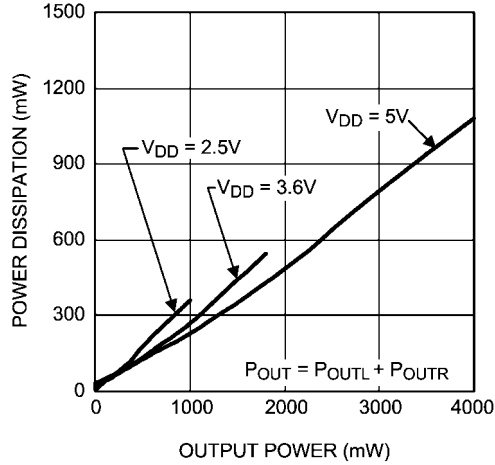

30010677

Power Dissipation vs Output Power
 $R_L = 8\Omega, f = 1\text{kHz}$

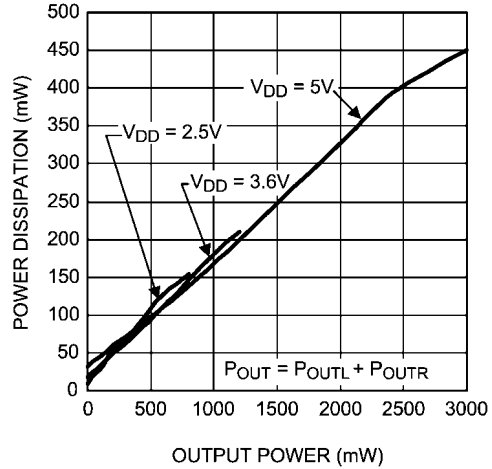

30010678

Output Power vs Supply Voltage
 $R_L = 4\Omega, f = 1\text{kHz}$

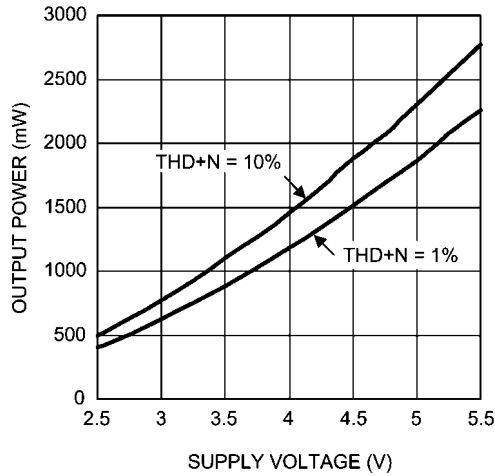

30010679

Output Power vs Supply Voltage
 $R_L = 8\Omega, f = 1\text{kHz}$

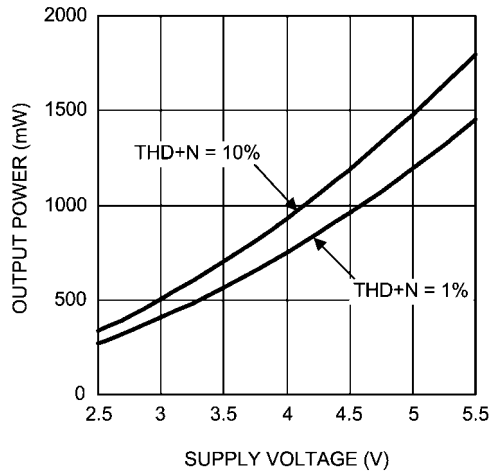

30010680

PSRR vs Frequency
 $V_{DD} = 3.6\text{V}, V_{RIPPLE} = 200\text{mV}_{P-P}, R_L = 8\Omega$

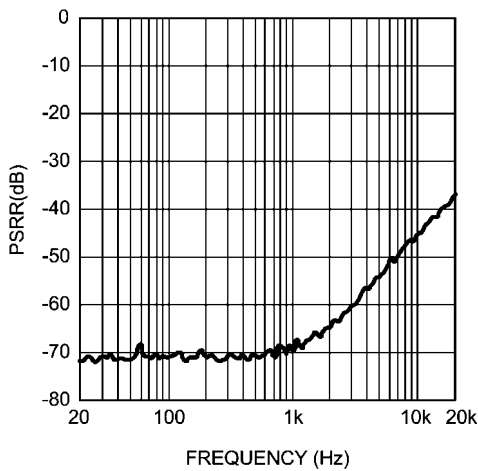

30010694

Crosstalk vs Frequency
 $V_{DD} = 3.6\text{V}, V_{RIPPLE} = 1\text{V}_{P-P}, R_L = 8\Omega$

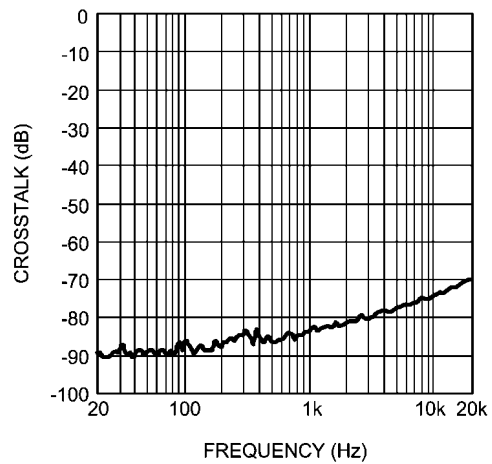

30010695

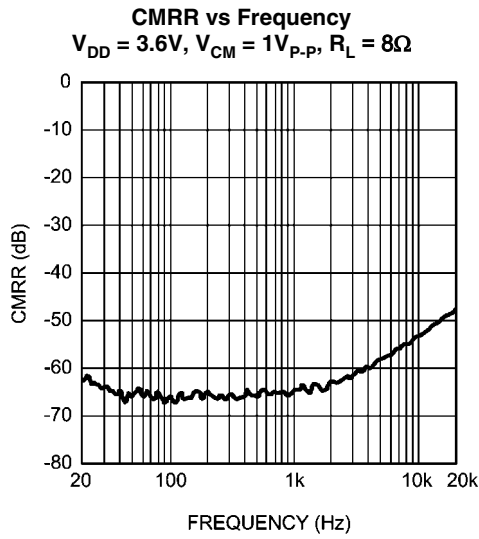

30010696

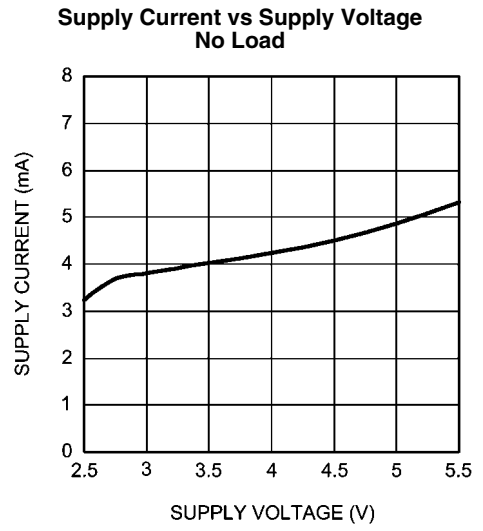

30010684

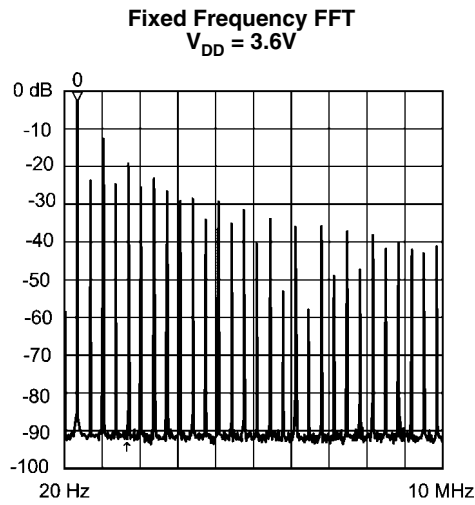

30010697

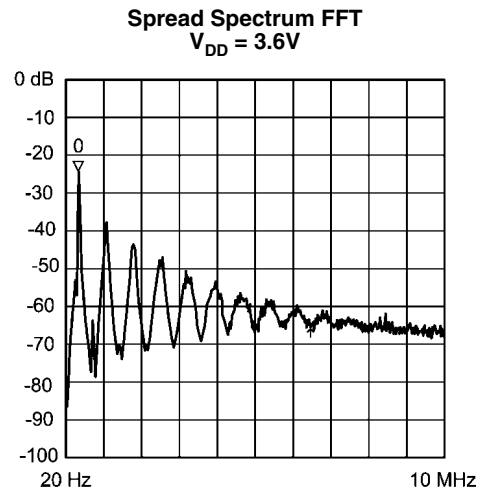

30010698

Application Information

GENERAL AMPLIFIER FUNCTION

The LM48410 stereo Class D audio power amplifier features a filterless modulation scheme that reduces external component count, conserving board space and reducing system cost. The outputs of the device transition from V_{DD} to GND with a 300kHz switching frequency. With no signal applied, the outputs switch with a 50% duty cycle, in phase, causing the two outputs to cancel. This cancellation results in no net voltage across the speaker, thus there is no current to the load in the idle state.

When an input signal is applied, the duty cycle (pulse width) of the LM48410 output's change. For increasing output voltage, the duty cycle of one side of each output increases, while the duty cycle of the other side of each output decreases. For decreasing output voltages, the converse occurs. The difference between the two pulse widths yields the differential output voltage.

FIXED FREQUENCY MODE

The LM48410 features two modulation schemes, a fixed frequency mode and a spread spectrum mode. Select the fixed frequency mode by setting $SS/\overline{FF} = \text{GND}$. In fixed frequency mode, the amplifier outputs switch at a constant 300kHz. In fixed frequency mode, the output spectrum consists of the fundamental and its associated harmonics (see **Typical Performance Characteristics**).

SPREAD SPECTRUM

The logic selectable spread spectrum mode eliminates the need for output filters, ferrite beads or chokes. In spread spectrum mode, the switching frequency varies randomly by 30% about a 300kHz center frequency, reducing the wide-band spectral content and improving EMI emissions radiated by the speaker and associated cables and traces. A fixed frequency class D exhibits large amounts of spectral energy at multiples of the switching frequency. The spread spectrum architecture of the LM48410 spreads the same energy over a larger bandwidth (See **Typical Performance Characteristics**). The cycle-to-cycle variation of the switching period does not affect the audio reproduction, efficiency, or PSRR. Set $SS/\overline{FF} = V_{DD}$ for spread spectrum mode.

DIFFERENTIAL AMPLIFIER EXPLANATION

As logic supplies continue to shrink, system designers are increasingly turning to differential analog signal handling to preserve signal to noise ratios with restricted voltage swings. The LM48410 features two fully differential speaker amplifiers. A differential amplifier amplifies the difference between the two input signals. Traditional audio power amplifiers have typically offered only single-ended inputs resulting in a 6dB reduction of SNR relative to differential inputs. The LM48410 also offers the possibility of DC input coupling which eliminates the input coupling capacitors. A major benefit of the fully differential amplifier is the improved common mode rejection ratio (CMRR) over single-ended input amplifiers. The increased CMRR of the differential amplifier reduces sensitivity to ground offset related noise injection, especially important in noisy systems.

POWER DISSIPATION AND EFFICIENCY

The major benefit of a Class D amplifier is increased efficiency versus a Class AB. The efficiency of the LM48410 is attributed to the region of operation of the transistors in the output stage. The Class D output stage acts as current steering switches,

consuming negligible amounts of power compared to a Class AB amplifier. Most of the power loss associated with the output stage is due to the IR loss of the MOSFET on-resistance, along with switching losses due to gate charge.

SHUTDOWN FUNCTION

The LM48410 features independent left and right channel shutdown controls, allowing each channel to be disabled independently. \overline{SDR} controls the right channel, while \overline{SDL} controls the left channel. Driving either low disables the corresponding channel, reducing supply current to 0.1 μ A.

It is best to switch between ground and V_{DD} for minimum current consumption while in shutdown. The LM48410 may be disabled with shutdown voltages in between GND and V_{DD} , the idle current will be greater than the typical 0.1 μ A value.

The LM48410 shutdown inputs have internal pulldown resistors. The purpose of these resistors is to eliminate any unwanted state changes when \overline{SD} is floating. To minimize shutdown current, \overline{SD} should be driven to GND or left floating. If \overline{SD} is not driven to GND or floating, an increase in shutdown supply current will be noticed.

PROPER SELECTION OF EXTERNAL COMPONENTS

Power Supply Bypassing/Filtering

Proper power supply bypassing is important for low noise performance and high PSRR. Place the supply bypass capacitor as close to the device as possible. Typical applications employ a voltage regulator with 10 μ F and 0.1 μ F bypass capacitors that increase supply stability. These capacitors do not eliminate the need for bypassing of the LM48410 supply pins. A 1 μ F capacitor is recommended.

Input Capacitor Selection

Input capacitors may be required for some applications, or when the audio source is single-ended. Input capacitors block the DC component of the audio signal, eliminating any conflict between the DC component of the audio source and the bias voltage of the LM48410. The input capacitors create a high-pass filter with the input resistance R_{IN} . The -3dB point of the high-pass filter is found using Equation 1 below.

$$f = 1 / 2\pi R_{IN} C_{IN} \quad (1)$$

The values for R_{IN} can be found in the Electrical Characteristics table for each gain setting.

The input capacitors can also be used to remove low frequency content from the audio signal. Small speakers cannot reproduce, and may even be damaged by low frequencies. High-pass filtering the audio signal helps protect the speakers. When the LM48410 is using a single-ended source, power supply noise on the ground is seen as an input signal. Setting the high-pass filter point above the power supply noise frequencies, 217 Hz in a GSM phone, for example, filters out the noise such that it is not amplified and heard on the output. Capacitors with a tolerance of 10% or better are recommended for impedance matching and improved CMRR and PSRR.

National 3D Enhancement

The LM48410 features National's 3D enhancement effect that widens the perceived soundstage of a stereo audio signal. The 3D enhancement increases the apparent stereo channel separation, improving audio reproduction whenever the left and right speakers are too close to one another.

An external RC network shown in Figure 1 is required to enable the 3D effect. Because the LM48410 is a fully differential

amplifier, there are two separate RC networks, one for each stereo input pair (INL+ and INR+, and INL- and INR-). Set 3DEN high to enable the 3D effect. Set 3DEN low to disable the 3D effect.

The 3D RC network acts as a high pass filter. The amount of the 3D effect is set by the R_{3D} resistor. Decreasing the value of R_{3D} increases the 3D effect. The C_{3D} capacitor sets the frequency at which the 3D effect occurs. Increasing the value of C_{3D} decreases the low frequency cutoff point, extending the 3D effect over a wider bandwidth. The low frequency cut-off point is given by:

$$f_{3D(-3dB)} = 1 / 2\pi(R_{3D})(C_{3D})$$

Enabling the 3D effect increase the gain by a factor of $(1 + 20k\Omega/R_{3D})$. Setting R_{3D} to $20k\Omega$ results in a gain increase of 6dB whenever the 3D effect is enabled. In fully differential configuration, the component values of the two RC networks must be identical. Any component variations can affect the sound quality of the 3D effect. In single-ended configuration, only the RC network of the input pairs being driven by the audio source needs to be connected. For instance, if audio is applied to INR+ and INL+, then a 3D network must be con-

nected between 3DL+ and 3DR+. 3DL- and 3DR- can be left unconnected.

AUDIO AMPLIFIER GAIN SETTING

The LM48410 features four internally configured gain settings. The device gain is selected through the two logic inputs, G0 and G1. The gain settings are as shown in the following table.

TABLE 1.

LOGIC INPUT		GAIN	
G1	G0	V/V	dB
0	0	2	6
0	1	4	12
1	0	8	18
1	1	16	24

SINGLE-ENDED AUDIO AMPLIFIER CONFIGURATION

The LM48410 is compatible with single-ended sources. When configured for single-ended inputs, input capacitors must be used to block and DC component at the input of the device. Figure 2 shows the typical single-ended applications circuit.

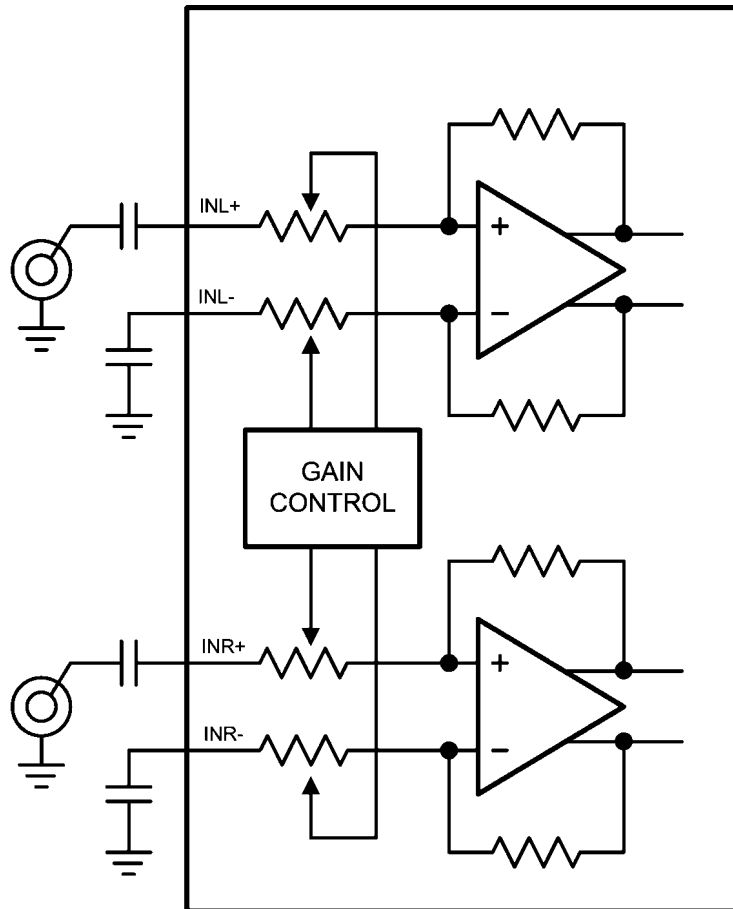

300106a1

FIGURE 2. Single-Ended Circuit Diagram

PCB LAYOUT GUIDELINES

As output power increases, interconnect resistance (PCB traces and wires) between the amplifier, load and power supply create a voltage drop. The voltage loss due to the traces between the LM48410 and the load results in lower output power and decreased efficiency. Higher trace resistance between the supply and the LM48410 has the same effect as a poorly regulated supply, increasing ripple on the supply line, and reducing peak output power. The effects of residual trace resistance increases as output current increases due to higher output power, decreased load impedance or both. To maintain the highest output voltage swing and corresponding peak output power, the PCB traces that connect the output pins to the load and the supply pins to the power supply should be as wide as possible to minimize trace resistance.

The use of power and ground planes will give the best THD +N performance. In addition to reducing trace resistance, the use of power planes creates parasitic capacitors that help to filter the power supply line.

The inductive nature of the transducer load can also result in overshoot on one or both edges, clamped by the parasitic diodes to GND and V_{DD} in each case. From an EMI stand-

point, this is an aggressive waveform that can radiate or conduct to other components in the system and cause interference. It is essential to keep the power and output traces short and well shielded if possible. Use of ground planes beads and micro-strip layout techniques are all useful in preventing unwanted interference.

As the distance from the LM48410 and the speaker increases, the amount of EMI radiation increases due to the output wires or traces acting as antennas. An antenna becomes a more efficient radiator with length. Ferrite chip inductors placed close to the LM48410 outputs may be needed to reduce EMI radiation.

EXPOSED-DAP MOUNTING CONSIDERATIONS

The LM48410 LLP package features an exposed thermal pad on its underside (DAP, or die attach paddle). The exposed DAP lowers the package's thermal resistance by providing a direct heat conduction path from the die to the printed circuit board. Connect the exposed thermal pad to GND through a large pad and multiple vias to a GND plane on the bottom of the PCB.

Bill of Materials

TABLE 2. LM48410SQ Demo Board Bill of Materials

Designation	Qty	Description	Recommended Manufacturer	Part Number
C1–C4	4	1 μ F \pm 10%, 16V X7R ceramic capacitors (1206)	Panasonic	ECJ-3YB1C105K
C5–C9	5	1 μ F \pm 10%, 16V X7R ceramic capacitors (603)	Panasonic	ECJ-1VB1C105K
C10	1	1 μ F \pm 10%, 16V X7R tantalum capacitors (B-case))	AVX	TPSB106K016R0800
R1, R2	2	82k Ω \pm 5% resistor (603)		
R3, R4	2	100k Ω potentiometer		ST4B104CT
T1, T2	2	Common mode choke, A1, 800 Ω at 100Hz	TDK	ACM4532–801
JU1–JU6	6	3-pin header		
U1		LM48410SQ (24-pin SQA, 4mm x 4mm x 0.8mm)	National Semiconductor	

LM48410 Demonstration Board Schematic Diagram

LM48410

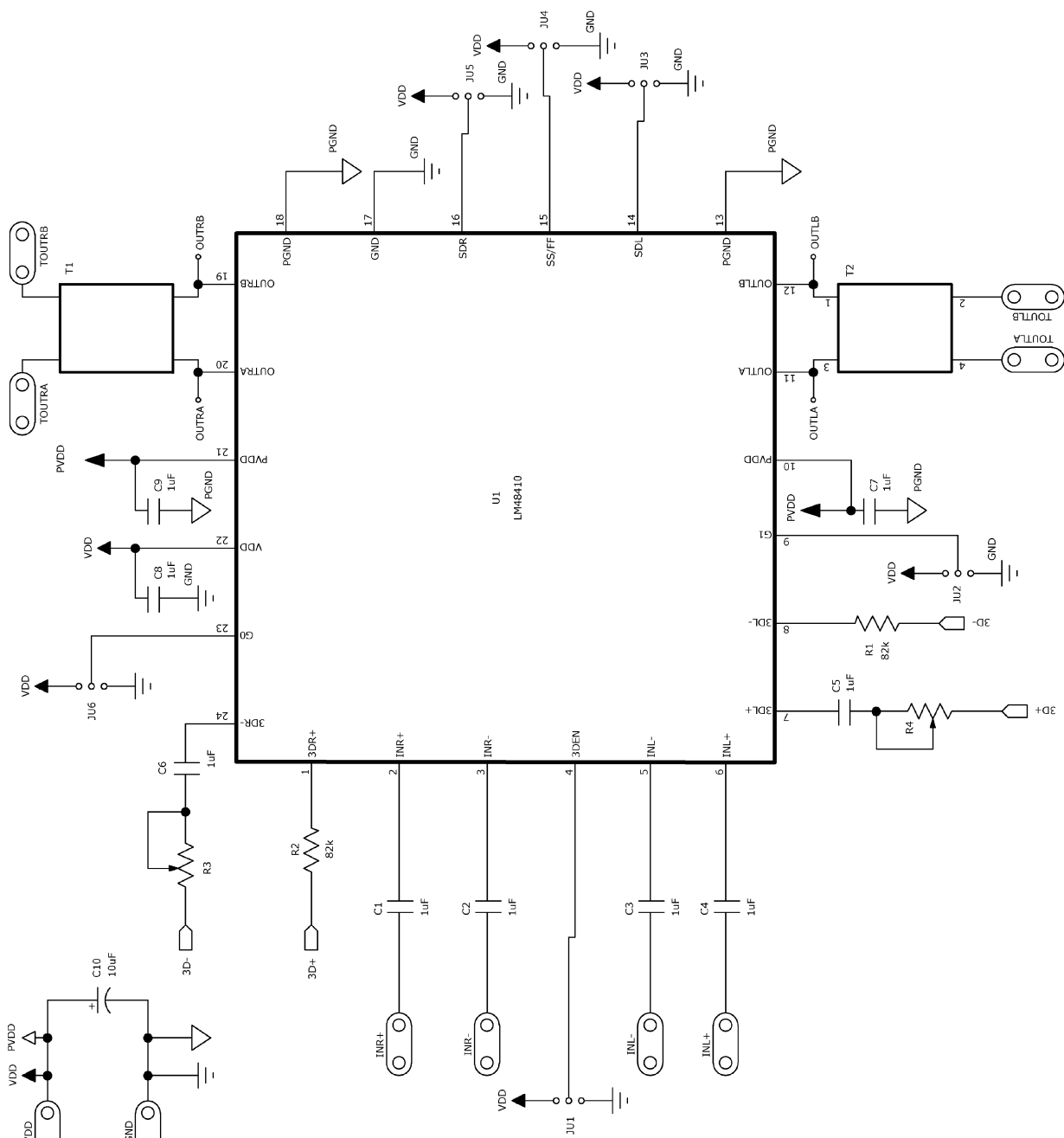

30010656

Demoboard PCB Layout

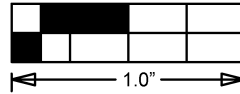
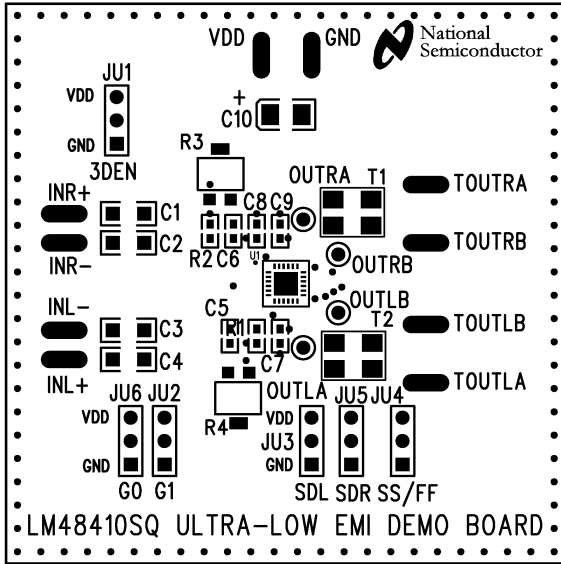

Top Silkscreen

30010654

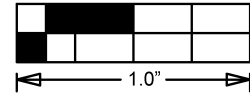
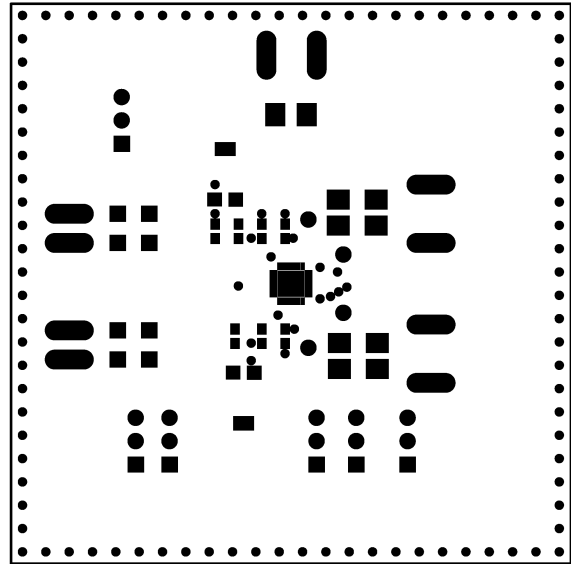

Top Soldermask

30010655

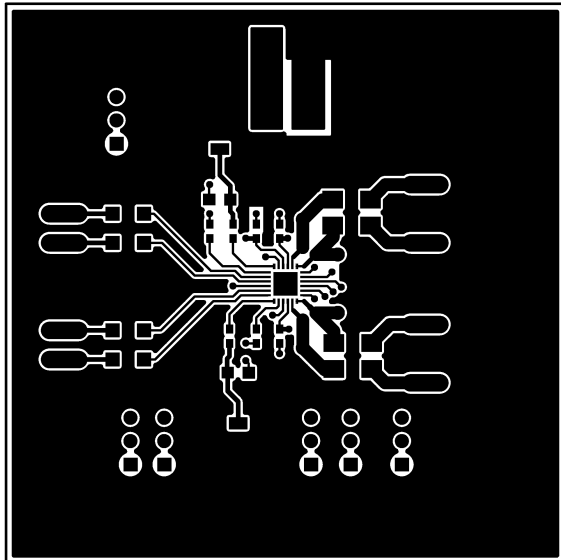

Top Layer

30010653

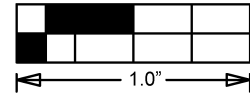
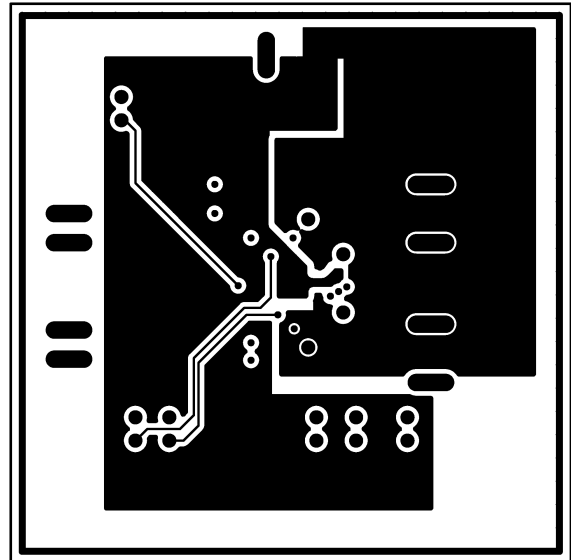

Layer 2

30010651

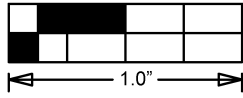
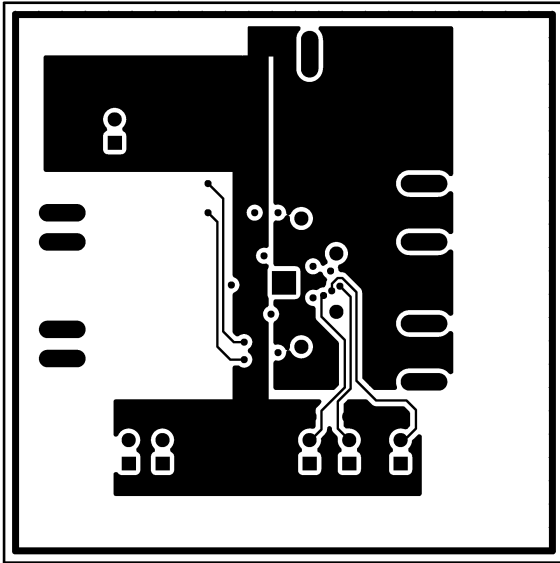

Layer 3

30010652

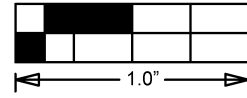
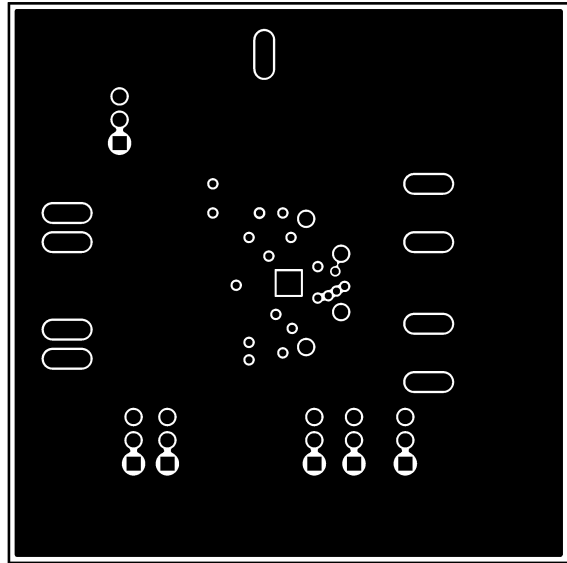

Bottom Layer

30010649

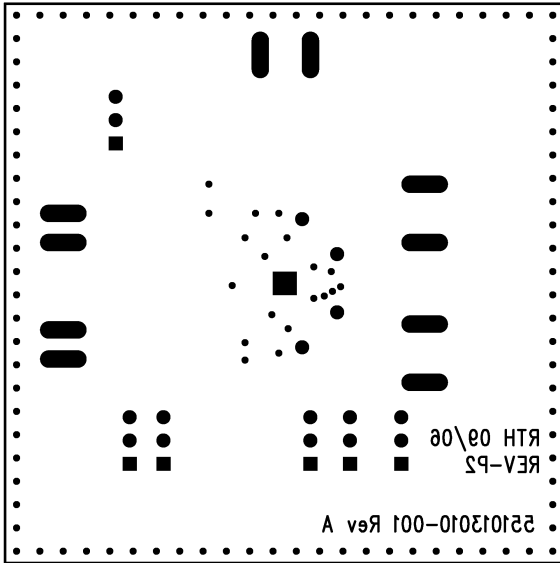

Bottom Silkscreen

30010650

Revision Table

Rev	Date	Description
1.0	02/21/07	Initial release.
1.1	03/19/07	Text edits.
1.2	07/11/07	Added the demo boards and schematic diagram.
1.3	02/22/08	Fixed the PID (product folder).
1.4	04/29/08	Text edits.
1.5	07/03/08	Text edits (under SHUTDOWN FUNCTION).

Physical Dimensions inches (millimeters) unless otherwise noted

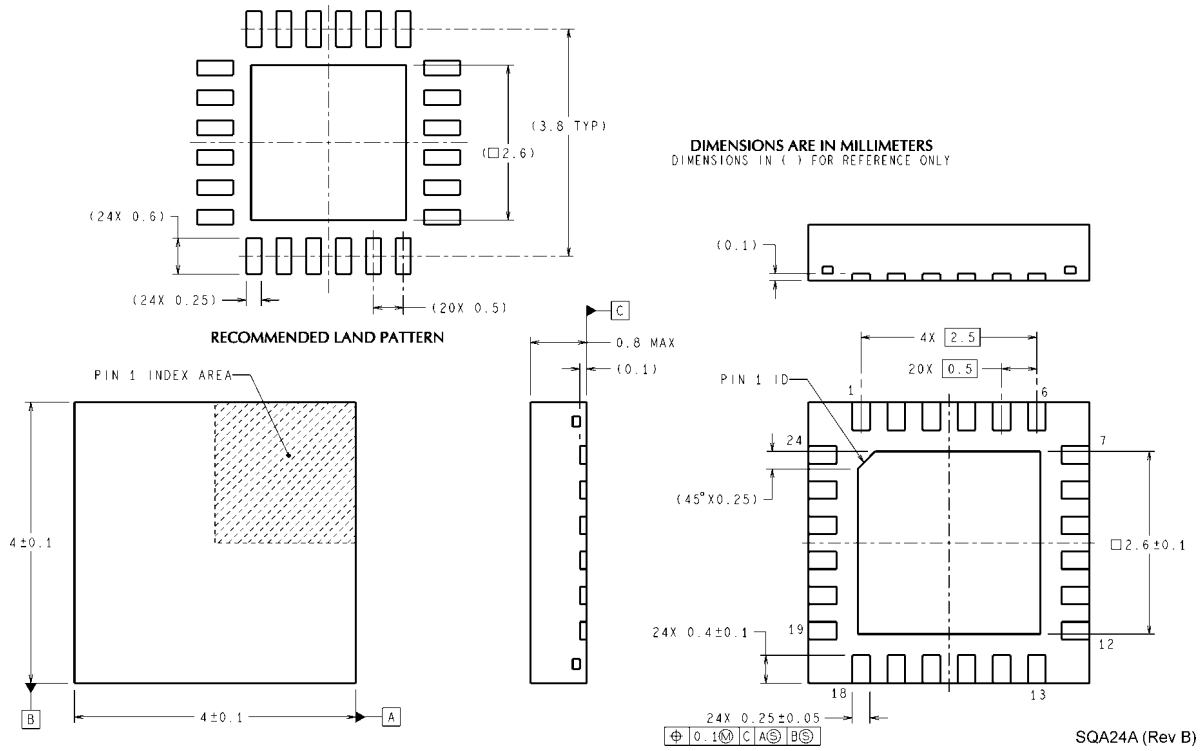

LLP Package
Order Number LM48410SQ
NS Package Number SQA24A

Notes

For more National Semiconductor product information and proven design tools, visit the following Web sites at:

Products		Design Support	
Amplifiers	www.national.com/amplifiers	WEBENCH	www.national.com/webench
Audio	www.national.com/audio	Analog University	www.national.com/AU
Clock Conditioners	www.national.com/timing	App Notes	www.national.com/appnotes
Data Converters	www.national.com/adc	Distributors	www.national.com/contacts
Displays	www.national.com/displays	Green Compliance	www.national.com/quality/green
Ethernet	www.national.com/ethernet	Packaging	www.national.com/packaging
Interface	www.national.com/interface	Quality and Reliability	www.national.com/quality
LVDS	www.national.com/lvds	Reference Designs	www.national.com/refdesigns
Power Management	www.national.com/power	Feedback	www.national.com/feedback
Switching Regulators	www.national.com/switchers		
LDOs	www.national.com/lido		
LED Lighting	www.national.com/led		
PowerWise	www.national.com/powerwise		
Serial Digital Interface (SDI)	www.national.com/sdi		
Temperature Sensors	www.national.com/tempsensors		
Wireless (PLL/VCO)	www.national.com/wireless		

THE CONTENTS OF THIS DOCUMENT ARE PROVIDED IN CONNECTION WITH NATIONAL SEMICONDUCTOR CORPORATION ("NATIONAL") PRODUCTS. NATIONAL MAKES NO REPRESENTATIONS OR WARRANTIES WITH RESPECT TO THE ACCURACY OR COMPLETENESS OF THE CONTENTS OF THIS PUBLICATION AND RESERVES THE RIGHT TO MAKE CHANGES TO SPECIFICATIONS AND PRODUCT DESCRIPTIONS AT ANY TIME WITHOUT NOTICE. NO LICENSE, WHETHER EXPRESS, IMPLIED, ARISING BY ESTOPPEL OR OTHERWISE, TO ANY INTELLECTUAL PROPERTY RIGHTS IS GRANTED BY THIS DOCUMENT.

TESTING AND OTHER QUALITY CONTROLS ARE USED TO THE EXTENT NATIONAL DEEMS NECESSARY TO SUPPORT NATIONAL'S PRODUCT WARRANTY. EXCEPT WHERE MANDATED BY GOVERNMENT REQUIREMENTS, TESTING OF ALL PARAMETERS OF EACH PRODUCT IS NOT NECESSARILY PERFORMED. NATIONAL ASSUMES NO LIABILITY FOR APPLICATIONS ASSISTANCE OR BUYER PRODUCT DESIGN. BUYERS ARE RESPONSIBLE FOR THEIR PRODUCTS AND APPLICATIONS USING NATIONAL COMPONENTS. PRIOR TO USING OR DISTRIBUTING ANY PRODUCTS THAT INCLUDE NATIONAL COMPONENTS, BUYERS SHOULD PROVIDE ADEQUATE DESIGN, TESTING AND OPERATING SAFEGUARDS.

EXCEPT AS PROVIDED IN NATIONAL'S TERMS AND CONDITIONS OF SALE FOR SUCH PRODUCTS, NATIONAL ASSUMES NO LIABILITY WHATSOEVER, AND NATIONAL DISCLAIMS ANY EXPRESS OR IMPLIED WARRANTY RELATING TO THE SALE AND/OR USE OF NATIONAL PRODUCTS INCLUDING LIABILITY OR WARRANTIES RELATING TO FITNESS FOR A PARTICULAR PURPOSE, MERCHANTABILITY, OR INFRINGEMENT OF ANY PATENT, COPYRIGHT OR OTHER INTELLECTUAL PROPERTY RIGHT.

LIFE SUPPORT POLICY

NATIONAL'S PRODUCTS ARE NOT AUTHORIZED FOR USE AS CRITICAL COMPONENTS IN LIFE SUPPORT DEVICES OR SYSTEMS WITHOUT THE EXPRESS PRIOR WRITTEN APPROVAL OF THE CHIEF EXECUTIVE OFFICER AND GENERAL COUNSEL OF NATIONAL SEMICONDUCTOR CORPORATION. As used herein:

Life support devices or systems are devices which (a) are intended for surgical implant into the body, or (b) support or sustain life and whose failure to perform when properly used in accordance with instructions for use provided in the labeling can be reasonably expected to result in a significant injury to the user. A critical component is any component in a life support device or system whose failure to perform can be reasonably expected to cause the failure of the life support device or system or to affect its safety or effectiveness.

National Semiconductor and the National Semiconductor logo are registered trademarks of National Semiconductor Corporation. All other brand or product names may be trademarks or registered trademarks of their respective holders.

Copyright© 2008 National Semiconductor Corporation

For the most current product information visit us at www.national.com



National Semiconductor Americas Technical Support Center
 Email: support@nsc.com
 Tel: 1-800-272-9959

National Semiconductor Europe Technical Support Center
 Email: europe.support@nsc.com
 German Tel: +49 (0) 180 5010 771
 English Tel: +44 (0) 870 850 4288

National Semiconductor Asia Pacific Technical Support Center
 Email: ap.support@nsc.com

National Semiconductor Japan Technical Support Center
 Email: jpn.feedback@nsc.com