

Wide Voltage Range 1.8 Watt Audio Amplifier

General Description

The LM4951 is an audio power amplifier primarily designed for demanding applications in Portable Handheld devices. It is capable of delivering 1.8W mono BTL to an 8Ω load, continuous average power, with less than 1% distortion (THD+N) from a 7.5V_{DC} power supply.

Boomer audio power amplifiers were designed specifically to provide high quality output power with a minimal amount of external components. The LM4951 does not require bootstrap capacitors, or snubber circuits.

The LM4951 features a low-power consumption active-low shutdown mode. Additionally, the LM4951 features an internal thermal shutdown protection mechanism.

The LM4951 contains advanced pop & click circuitry that eliminates noises which would otherwise occur during turn-on and turn-off transitions.

The LM4951 is unity-gain stable and can be configured by external gain-setting resistors.

Key Specifications

■ Wide Voltage Range	2.7V to 9V
■ Quiescent Power Supply Current (V _{DD} = 7.5V)	2.5mA (typ)
■ Power Output BTL at 7.5V, 1% THD	1.8W (typ)
■ Shutdown Current	0.01μA (typ)
■ Fast Turn on Time	25ms (typ)

Features

- Pop & click circuitry eliminates noise during turn-on and turn-off transitions
- Low current, active-low shutdown mode
- Low quiescent current
- Thermal shutdown protection
- Unity-gain stable
- External gain configuration capability

Applications

- Portable Handheld Devices up to 9V
- Cell Phone
- PDA

Typical Application

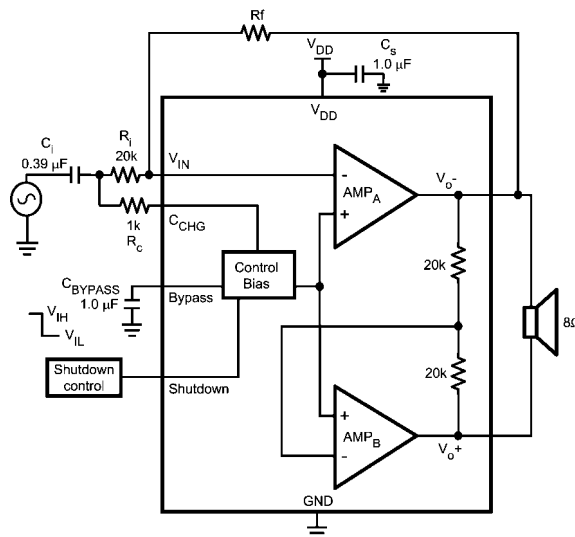

200942f4

* R_C is needed for over/under voltage protection. If inputs are less than V_{DD} +0.3V and greater than -0.3V, and if inputs are disabled when in shutdown mode, then R_C may be shorted.

FIGURE 1. Typical Bridge-Tied-Load (BTL) Audio Amplifier Application Circuit

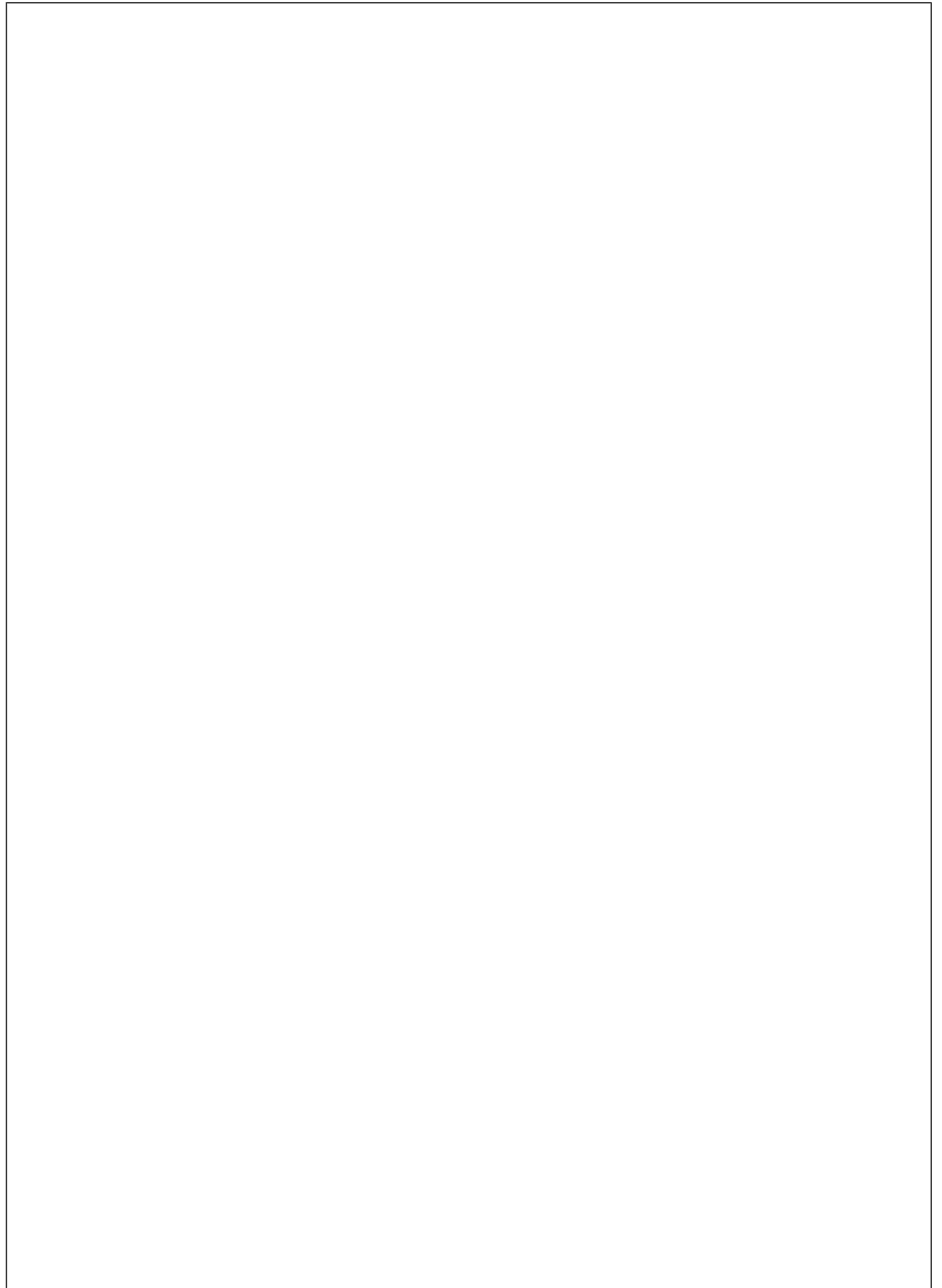

Connection Diagrams

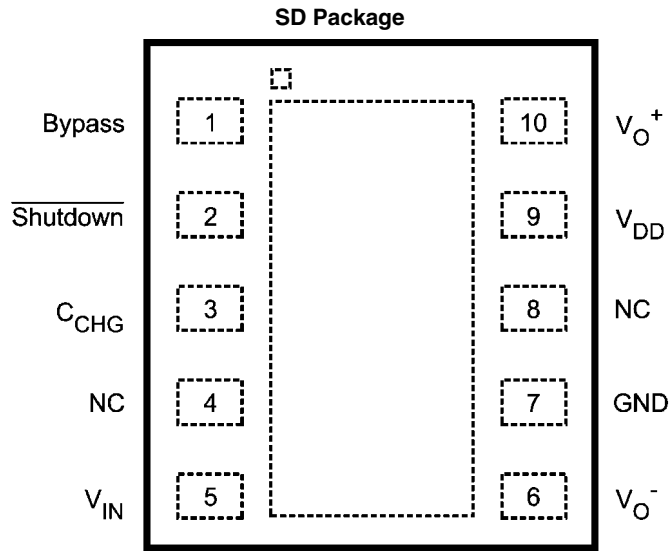

20094229

Top View
Order Number LM4951SD
See NS Package Number SDC10A

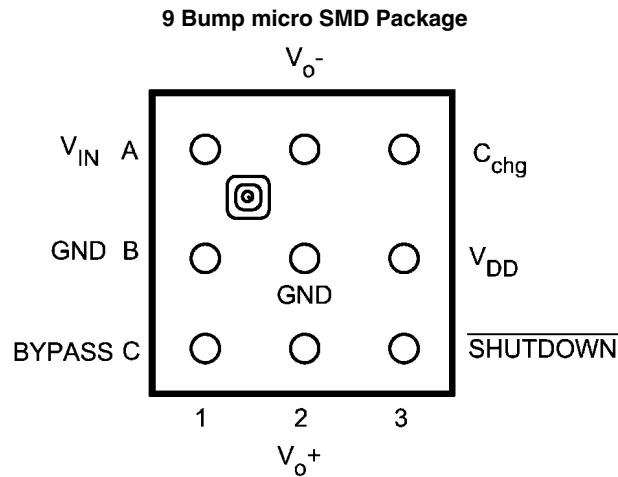

20094228

Top View
Order Number LM4951TL, TLX
See NS Package Number TLA09ZZA

* DAP can either be soldered to GND or left floating.

Absolute Maximum Ratings (Notes 1, 2)

If Military/Aerospace specified devices are required, please contact the National Semiconductor Sales Office/ Distributors for availability and specifications.

Supply Voltage	9.5V
Storage Temperature	-65°C to +150°C
Input Voltage	-0.3V to $V_{DD} + 0.3V$
Power Dissipation (Note 3)	Internally limited
ESD Susceptibility (Note 4)	2000V
ESD Susceptibility (Note 5)	200V

Junction Temperature	150°C
Thermal Resistance	
θ_{JA} (LLP) (Note 3)	52°C/W
See AN-1187 'Leadless Leadframe Packaging (LLP).'	

Operating Ratings

Temperature Range	
$T_{MIN} \leq T_A \leq T_{MAX}$	-40°C \leq T_A \leq +85°C
Supply Voltage	$2.7V \leq V_{DD} \leq 9V$

Electrical Characteristics $V_{DD} = 7.5V$ (Notes 1, 2)

The following specifications apply for $V_{DD} = 7.5V$, $A_{V-BTL} = 6dB$, $R_L = 8\Omega$ unless otherwise specified. Limits apply for $T_A = 25^\circ C$.

Symbol	Parameter	Conditions	LM4951		Units (Limits)
			Typical (Note 6)	Limit (Notes 7, 8)	
I_{DD}	Quiescent Power Supply Current	$V_{IN} = 0V, I_O = 0A, R_L = 8\Omega$	2.5	4.5	mA (max)
I_{SD}	Shutdown Current	$V_{SHUTDOWN} = GND$ (Note 9)	0.01	5	μA (max)
V_{OS}	Offset Voltage		5	30	mV (max)
V_{SDIH}	Shutdown Voltage Input High			1.2	V (min)
V_{SDIL}	Shutdown Voltage Input Low			0.4	V (max)
$R_{pulldown}$	Pulldown Resistor on S/D		75	45	$k\Omega$ (min)
T_{WU}	Wake-up Time	$C_B = 1.0\mu F$	25	35	ms
T_{sd}	Shutdown time	$C_B = 1.0\mu F$		10	ms (max)
TSD	Thermal Shutdown Temperature		170	150	$^\circ C$ (min)
				190	$^\circ C$ (max)
P_O	Output Power	THD = 1% (max); $f = 1kHz$ $R_L = 8\Omega$ Mono BTL	1.8	1.5	W (min)
THD+N	Total Harmonic Distortion + Noise	$P_O = 600mW_{rms}$; $f = 1kHz$ $A_{V-BTL} = 6dB$	0.07	0.5	% (max)
THD+N	Total Harmonic Distortion + Noise	$P_O = 600mW_{rms}$; $f = 1kHz$ $A_{V-BTL} = 26dB$	0.35		%
ϵ_{OS}	Output Noise	A-Weighted Filter, $R_i = R_f = 20k\Omega$ Input Referred, Note 10	10		μV
PSRR	Power Supply Rejection Ratio	$V_{RIPPLE} = 200mV_{p-p}$, $f = 217Hz$, $C_B = 1.0\mu F$, Input Referred	66	56	dB (min)

Electrical Characteristics $V_{DD} = 3.3V$ (Notes 1, 2)

The following specifications apply for $V_{DD} = 3.3V$, $A_{V-BTL} = 6dB$, $R_L = 8\Omega$ unless otherwise specified. Limits apply for $T_A = 25^\circ C$.

Symbol	Parameter	Conditions	LM4951		Units (Limits)
			Typical (Note 6)	Limit (Notes 7, 8)	
I_{DD}	Quiescent Power Supply Current	$V_{IN} = 0V, I_O = 0A, R_L = 8\Omega$	2.5	4.5	mA (max)
I_{SD}	Shutdown Current	$V_{SHUTDOWN} = GND$ (Note 9)	0.01	2	μA (max)
V_{OS}	Offset Voltage		3	30	mV (max)
V_{SDIH}	Shutdown Voltage Input High			1.2	V (min)
V_{SDIL}	Shutdown Voltage Input Low			0.4	V (max)
T_{WU}	Wake-up Time	$C_B = 1.0\mu F$	25		ms (max)
T_{sd}	Shutdown time	$C_B = 1.0\mu F$		10	ms (max)
P_O	Output Power	THD = 1% (max); $f = 1kHz$ $R_L = 8\Omega$ Mono BTL	280	230	mW (min)

Symbol	Parameter	Conditions	LM4951		Units (Limits)
			Typical (Note 6)	Limit (Notes 7, 8)	
THD+N	Total Harmonic Distortion + Noise1	$P_O = 100\text{mWrms}$; $f = 1\text{kHz}$ $A_{V\text{-BTL}} = 6\text{dB}$	0.07	0.5	% (max)
THD+N	Total Harmonic Distortion + Noise1	$P_O = 100\text{mWrms}$; $f = 1\text{kHz}$ $A_{V\text{-BTL}} = 26\text{dB}$	0.35		%
ϵ_{OS}	Output Noise	A-Weighted Filter, $R_i = R_f = 20\text{k}\Omega$ Input Referred, Note 10	10		μV
PSRR	Power Supply Rejection Ratio	$V_{\text{RIPPLE}} = 200\text{mV}_{\text{p-p}}$, $f = 217\text{Hz}$, $C_B = 1\mu\text{F}$, Input Referred	71	61	dB (min)

Note 1: All voltages are measured with respect to the GND pin, unless otherwise specified.

Note 2: *Absolute Maximum Ratings* indicate limits beyond which damage to the device may occur. *Operating Ratings* indicate conditions for which the device is functional, but do not guarantee specific performance limits. *Electrical Characteristics* state DC and AC electrical specifications under particular test conditions which guarantee specific performance limits. This assumes that the device is within the Operating Ratings. Specifications are not guaranteed for parameters where no limit is given, however, the typical value is a good indication of device performance.

Note 3: The maximum power dissipation must be derated at elevated temperatures and is dictated by T_{JMAX} , θ_{JA} , and the ambient temperature, T_A . The maximum allowable power dissipation is $P_{\text{DMAX}} = (T_{\text{JMAX}} - T_A) / \theta_{\text{JA}}$ or the given in Absolute Maximum Ratings, whichever is lower. For the LM4951 typical application (shown in *Figure 1*) with $V_{\text{DD}} = 7.5\text{V}$, $R_L = 8\Omega$ mono-BTL operation the max power dissipation is 1.42W. $\theta_{\text{JA}} = 73^\circ\text{C/W}$.

Note 4: Human body model, 100pF discharged through a 1.5k Ω resistor.

Note 5: Machine Model, 220pF–240pF discharged through all pins.

Note 6: Typicals are measured at 25°C and represent the parametric norm.

Note 7: Limits are guaranteed to National's AOQL (Average Outgoing Quality Level).

Note 8: Datasheet min/max specification limits are guaranteed by design, test, or statistical analysis.

Note 9: Shutdown current is measured in a normal room environment. The Shutdown pin should be driven as close as possible to GND for minimum shutdown current.

Note 10: Noise measurements are dependent on the absolute values of the closed loop gain setting resistors (input and feedback resistors).

Typical Performance Characteristics

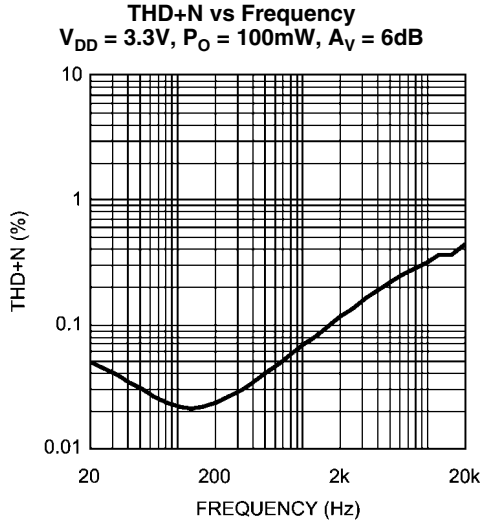

20094219

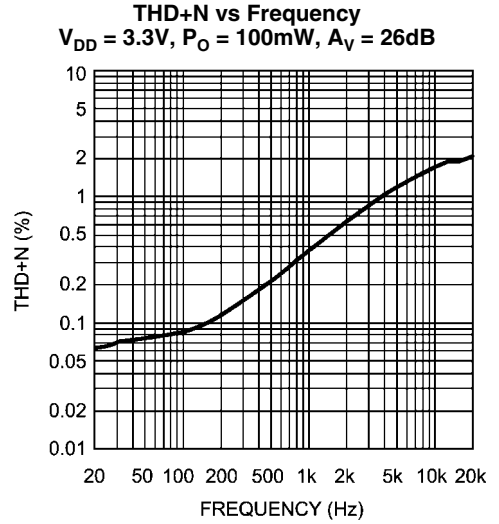

20094202

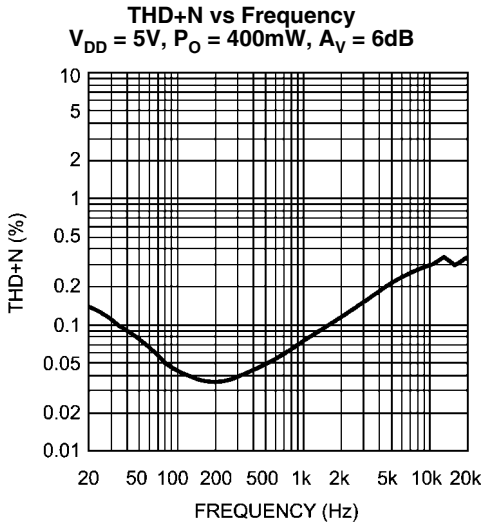

20094203

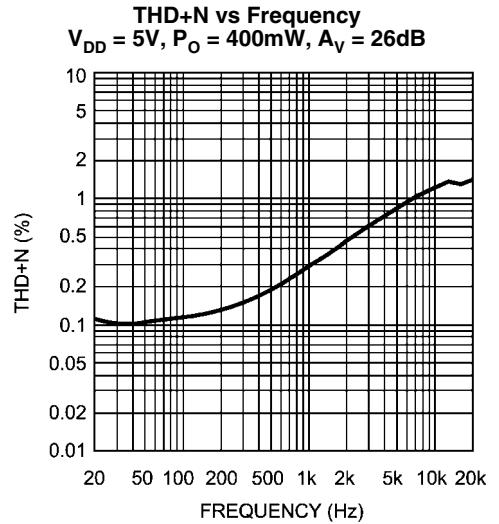

20094204

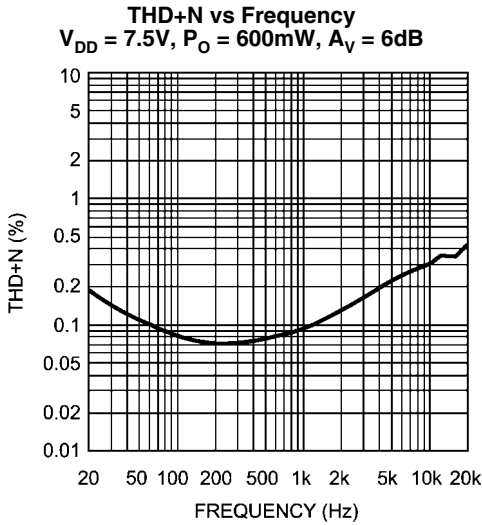

20094205

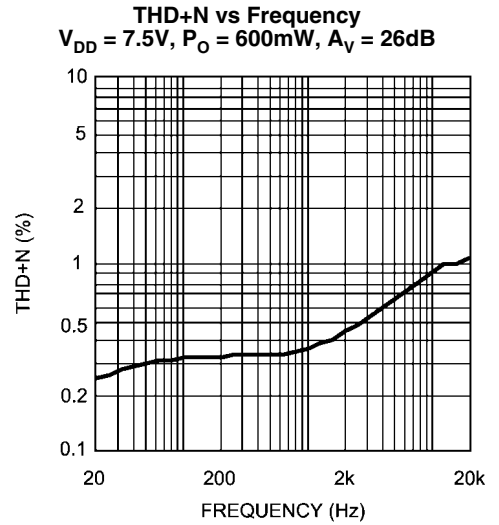

200942g0

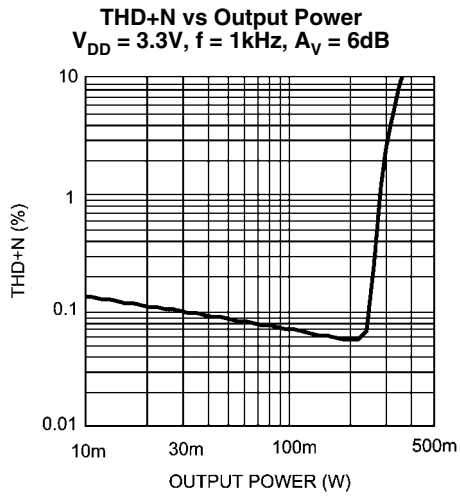

200942g1

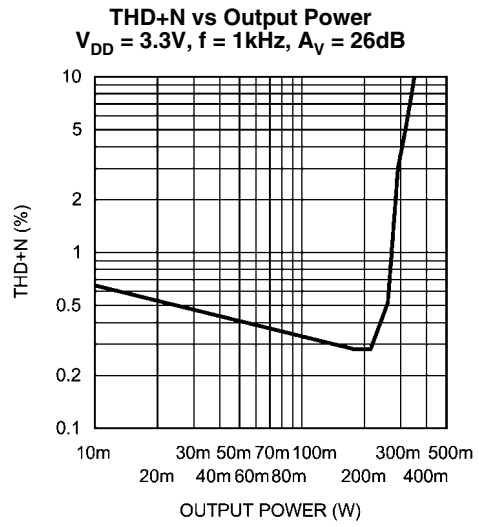

20094208

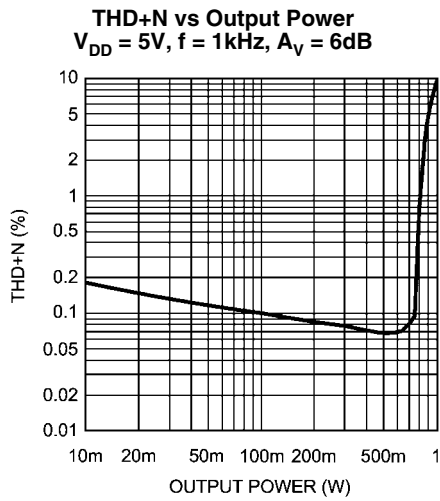

20094209

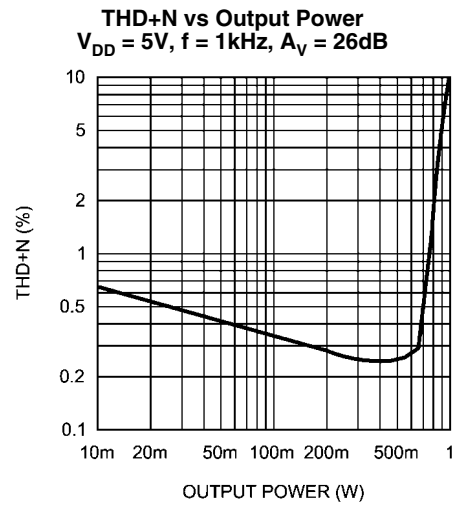

20094210

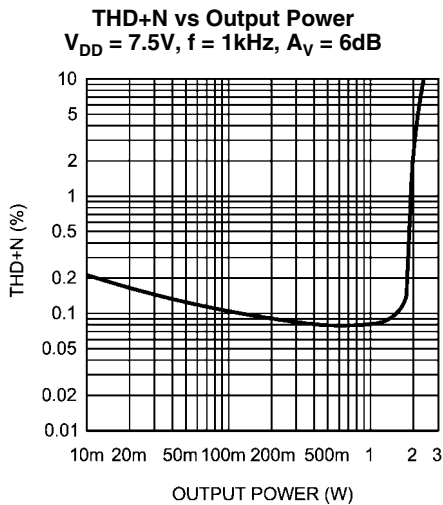

20094211

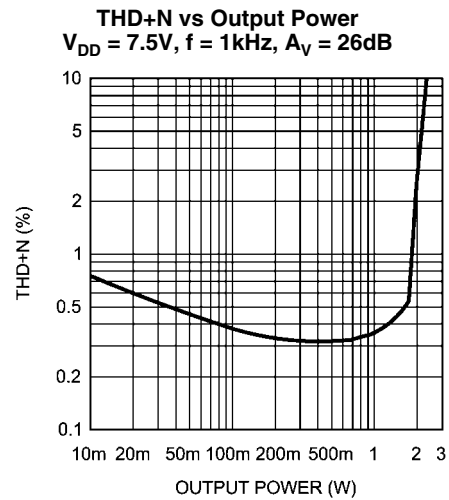

20094212

Power Supply Rejection vs Frequency
 $V_{DD} = 3.3V$, $A_V = 6dB$, $V_{RIPPLE} = 200mV_{P-P}$
 Input Terminated into 10Ω

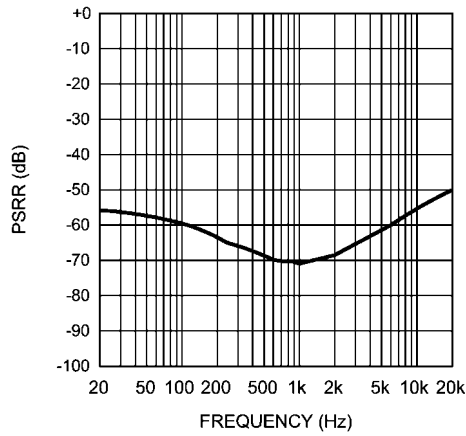

20094213

Power Supply Rejection vs Frequency
 $V_{DD} = 3.3V$, $A_V = 26dB$, $V_{RIPPLE} = 200mV_{P-P}$
 Input Terminated into 10Ω

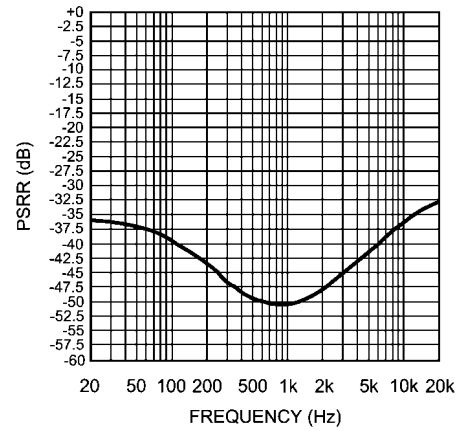

20094214

Power Supply Rejection vs Frequency
 $V_{DD} = 5V$, $A_V = 6dB$, $V_{RIPPLE} = 200mV_{P-P}$
 Input Terminated into 10Ω

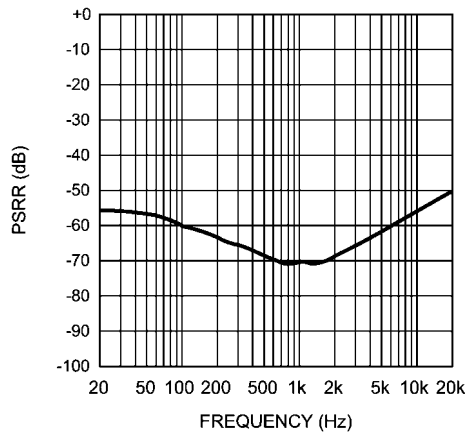

20094215

Power Supply Rejection vs Frequency
 $V_{DD} = 5V$, $A_V = 26dB$, $V_{RIPPLE} = 200mV_{P-P}$
 Input Terminated into 10Ω

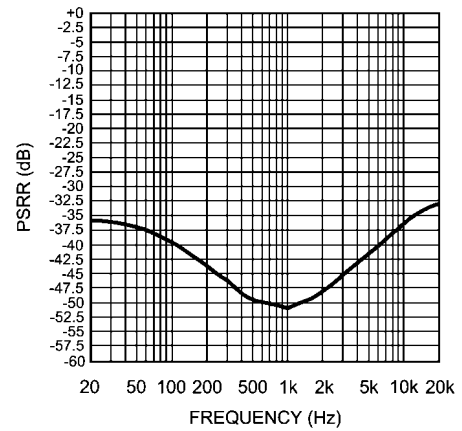

20094216

Power Supply Rejection vs Frequency
 $V_{DD} = 7.5V$, $A_V = 6dB$, $V_{RIPPLE} = 200mV_{P-P}$
 Input Terminated into 10Ω

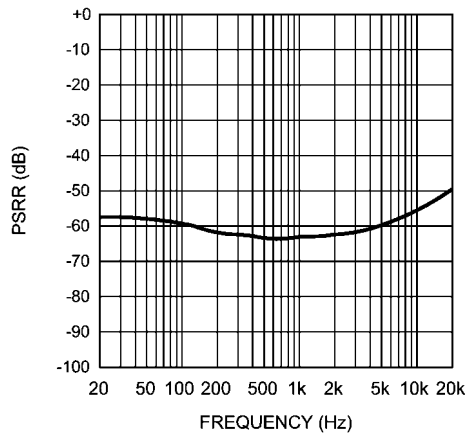

20094217

Power Supply Rejection vs Frequency
 $V_{DD} = 7.5V$, $A_V = 26dB$, $V_{RIPPLE} = 200mV_{P-P}$
 Input Terminated into 10Ω

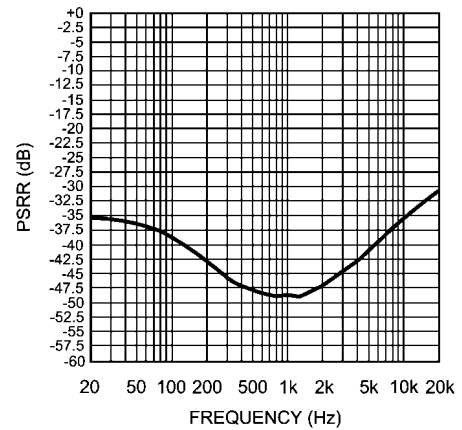

20094218

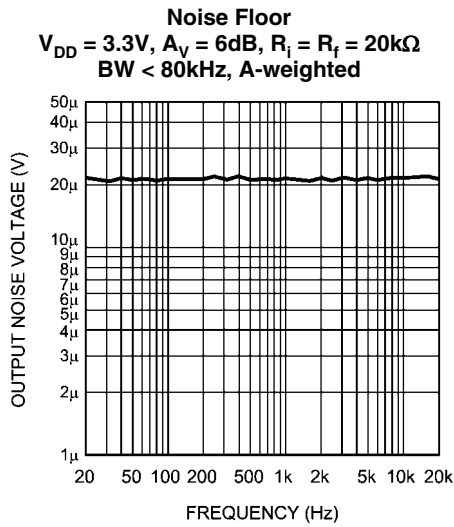

20094219

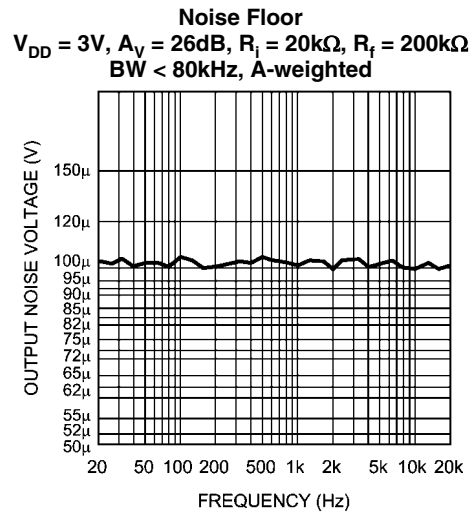

20094220

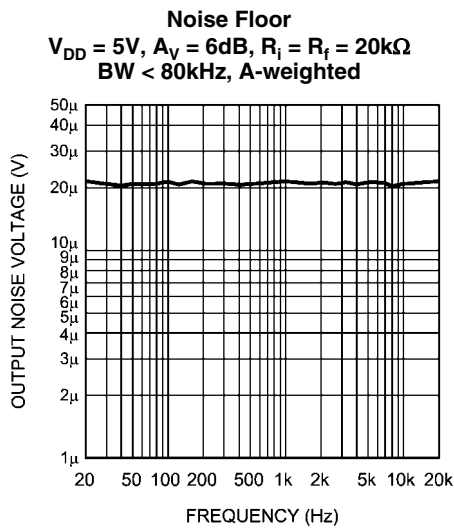

20094221

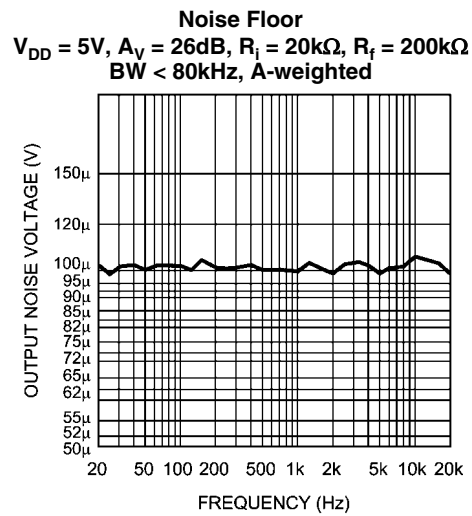

20094222

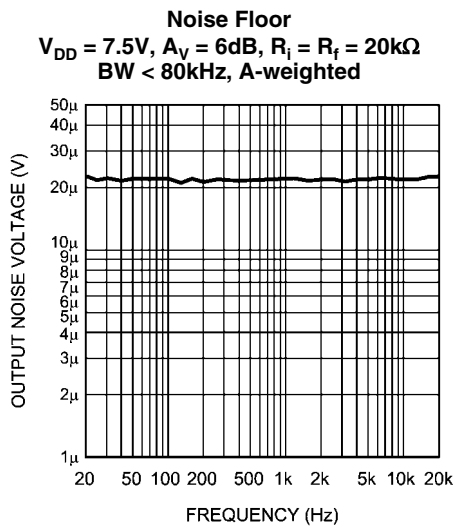

20094223

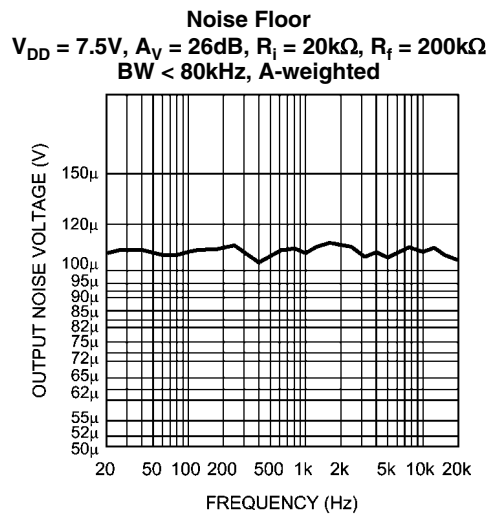

20094224

Power Dissipation vs Output Power
 $V_{DD} = 3.3V, R_L = 8\Omega, f = 1kHz$

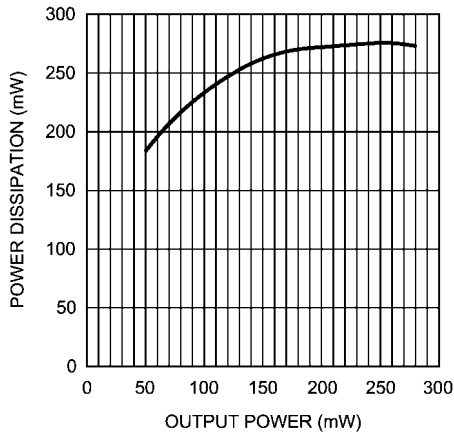

20094225

Power Dissipation vs Output Power
 $V_{DD} = 7.5V, R_L = 8\Omega, f = 1kHz$

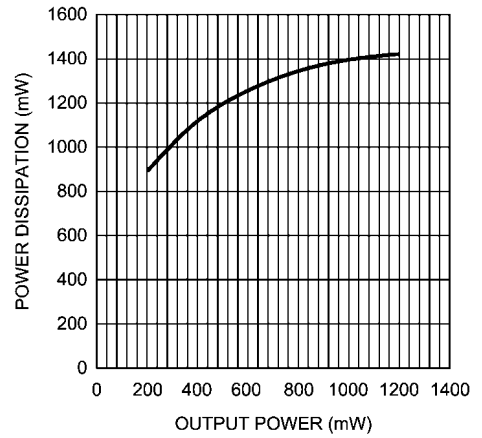

20094226

Supply Current vs Supply Voltage
 $R_L = 8\Omega, V_{IN} = 0V, R_{source} = 50\Omega$

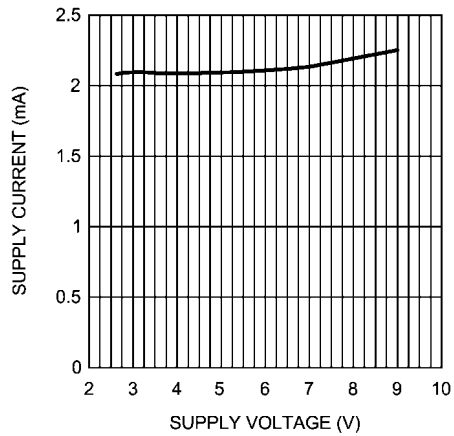

20094227

Clipping Voltage vs Supply Voltage
 $R_L = 8\Omega$
 from top to bottom: Negative Voltage Swing; Positive Voltage Swing

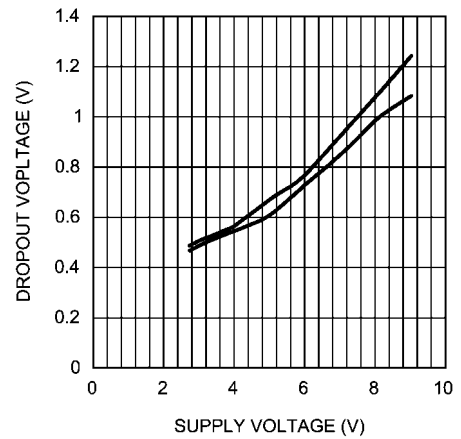

200942e9

Output Power vs Supply Voltage
 $R_L = 8\Omega$
 from top to bottom: THD+N = 10%, THD+N = 1%

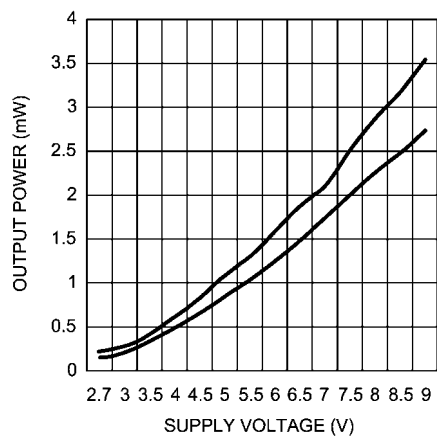

200942f0

Output Power vs Load Resistance
 $V_{DD} = 3.3V, f = 1kHz$
 from top to bottom: THD+N = 10%, THD+N = 1%

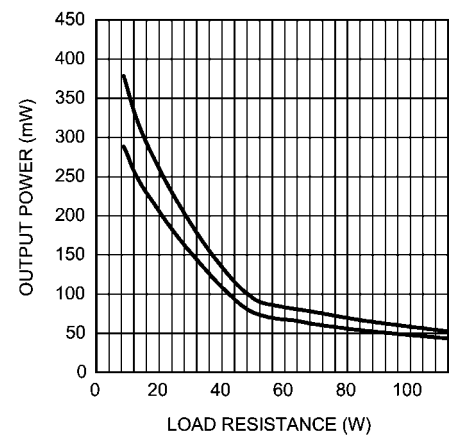

200942f1

Output Power vs Load Resistance
 $V_{DD} = 7.5V$, $f = 1kHz$
 from top to bottom: THD+N = 10%, THD+N = 1%

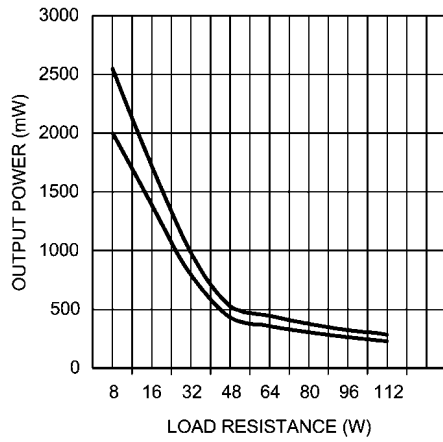

200942f2

Frequency Response vs Input Capacitor Size
 $R_L = 8\Omega$
 from top to bottom: $C_i = 1.0\mu F$, $C_i = 0.39\mu F$, $C_i = 0.039\mu F$

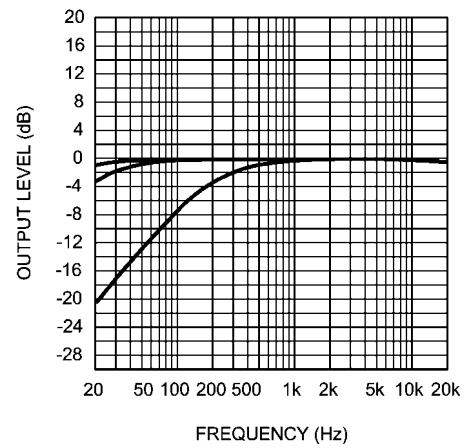

200942f3

Application Information

HIGH VOLTAGE BOOMER

Unlike previous 5V Boomer® amplifiers, the LM4951 is designed to operate over a power supply voltages range of 2.7V to 9V. Operating on a 7.5V power supply, the LM4951 will deliver 1.8W into an 8Ω BTL load with no more than 1% THD +N.

BRIDGE CONFIGURATION EXPLANATION

As shown in Figure 1, the LM4951 consists of two operational amplifiers that drive a speaker connected between their outputs. The value of input and feedback resistors determine the gain of each amplifier. External resistors R_i and R_f set the closed-loop gain of AMP_A, whereas two 20kΩ internal resistors set AMP_B's gain to -1. The LM4951 drives a load, such as a speaker, connected between the two amplifier outputs, V_{O+} and V_{O-} . Figure 1 shows that AMP_A's output serves as AMP_B's input. This results in both amplifiers producing signals identical in magnitude, but 180° out of phase. Taking advantage of this phase difference, a load is placed between AMP_A and AMP_B and driven differentially (commonly referred to as "bridge mode"). This results in a differential, or BTL, gain of

$$A_{VD} = 2(R_f / R_i) \quad (1)$$

Bridge mode amplifiers are different from single-ended amplifiers that drive loads connected between a single amplifier's output and ground. For a given supply voltage, bridge mode has a distinct advantage over the single-ended configuration: its differential output doubles the voltage swing across the load. Theoretically, this produces four times the output power when compared to a single-ended amplifier under the same conditions. This increase in attainable output power assumes that the amplifier is not current limited and that the output signal is not clipped. To ensure minimum output signal clipping when choosing an amplifier's closed-loop gain, refer to the **AUDIO POWER AMPLIFIER DESIGN** section. Under rare conditions, with unique combinations of high power supply voltage and high closed loop gain settings, the LM4951 may exhibit low frequency oscillations.

Another advantage of the differential bridge output is no net DC voltage across the load. This is accomplished by biasing AMP1's and AMP2's outputs at half-supply. This eliminates the coupling capacitor that single supply, single-ended amplifiers require. Eliminating an output coupling capacitor in a typical single-ended configuration forces a single-supply amplifier's half-supply bias voltage across the load. This increases internal IC power dissipation and may permanently damage loads such as speakers.

POWER DISSIPATION

Power dissipation is a major concern when designing a successful bridged amplifier.

The LM4951's dissipation when driving a BTL load is given by Equation (2). For a 7.5V supply and a single 8Ω BTL load, the dissipation is 1.42W.

$$P_{\text{DMAX-MONOBTL}} = 4(V_{\text{DD}})^2 / 2\pi^2 R_L \quad \text{Bridge Mode} \quad (2)$$

The maximum power dissipation point given by Equation (2) must not exceed the power dissipation given by Equation (3):

$$P_{\text{DMAX}}' = (T_{\text{JMAX}} - T_A) / \theta_{\text{JA}} \quad (3)$$

The LM4951's $T_{\text{JMAX}} = 150^\circ\text{C}$. In the SD package, the LM4951's θ_{JA} is 73°C/W when the metal tab is soldered to a copper plane of at least 1in^2 . This plane can be split between the top and bottom layers of a two-sided PCB. Connect the two layers together under the tab with an array of vias. At any given ambient temperature T_A , use Equation (3) to find the maximum internal power dissipation supported by the IC packaging. Rearranging Equation (3) and substituting P_{DMAX} for P_{DMAX}' results in Equation (4). This equation gives the maximum ambient temperature that still allows maximum stereo power dissipation without violating the LM4951's maximum junction temperature.

$$T_A = T_{\text{JMAX}} - P_{\text{DMAX-MONOBTL}} \theta_{\text{JA}} \quad (4)$$

For a typical application with a 7.5V power supply and a BTL 8Ω load, the maximum ambient temperature that allows maximum stereo power dissipation without exceeding the maximum junction temperature is approximately 46°C for the TS package.

$$T_{\text{JMAX}} = P_{\text{DMAX-MONOBTL}} \theta_{\text{JA}} + T_A \quad (5)$$

Equation (5) gives the maximum junction temperature T_{JMAX} . If the result violates the LM4951's 150°C , reduce the maximum junction temperature by reducing the power supply voltage or increasing the load resistance. Further allowance should be made for increased ambient temperatures.

The above examples assume that a device is operating around the maximum power dissipation point. Since internal power dissipation is a function of output power, higher ambient temperatures are allowed as output power or duty cycle decreases.

If the result of Equation (2) is greater than that of Equation (3), then decrease the supply voltage, increase the load impedance, or reduce the ambient temperature. Further, ensure that speakers rated at a nominal 8Ω do not fall below 6Ω. If these measures are insufficient, a heat sink can be added to reduce θ_{JA} . The heat sink can be created using additional copper area around the package, with connections to the ground pins, supply pin and amplifier output pins. Refer to the **Typical Performance Characteristics** curves for power dissipation information at lower output power levels.

POWER SUPPLY VOLTAGE LIMITS

Continuous proper operation is ensured by never exceeding the voltage applied to any pin, with respect to ground, as listed in the Absolute Maximum Ratings section.

POWER SUPPLY BYPASSING

As with any power amplifier, proper supply bypassing is critical for low noise performance and high power supply rejection. Applications that employ a voltage regulator typically use a 10μF in parallel with a 0.1μF filter capacitors to stabilize the regulator's output, reduce noise on the supply line, and improve the supply's transient response. However, their presence does not eliminate the need for a local 1.0μF tantalum bypass capacitance connected between the LM4951's supply pins and ground. Do not substitute a ceramic capacitor for the tantalum. Doing so may cause oscillation. Keep the length of

leads and traces that connect capacitors between the LM4951's power supply pin and ground as short as possible. Connecting a larger capacitor, C_{BYPASS} , between the BYPASS pin and ground improves the internal bias voltage's stability and improves the amplifier's PSRR. The PSRR improvements increase as the bypass pin capacitor value increases. Too large, however, increases turn-on time and can compromise the amplifier's click and pop performance. The selection of bypass capacitor values, especially C_{BYPASS} , depends on desired PSRR requirements, click and pop performance (as explained in the section, **SELECTING EXTERNAL COMPONENTS**), system cost, and size constraints.

MICRO-POWER SHUTDOWN

The LM4951 features an active-low micro-power shutdown mode. When active, the LM4951's micro-power shutdown feature turns off the amplifier's bias circuitry, reducing the supply current. The low 0.01 μ A typical shutdown current is achieved by applying a voltage to the SHUTDOWN pin that is as near to GND as possible. A voltage that is greater than GND may increase the shutdown current.

There are a few methods to control the micro-power shutdown. These include using a single-pole, single-throw switch (SPST), a microprocessor, or a microcontroller. When using a switch, connect the SPST switch between the shutdown pin and V_{DD} . Select normal amplifier operation by closing the switch. Opening the switch applies GND to the SHUTDOWN pin activating micro-power shutdown. The switch and internal pull-down resistor guarantee that the SHUTDOWN pin will not float. This prevents unwanted state changes. In a system with a microprocessor or a microcontroller, use a digital output to apply the active-state voltage to the SHUTDOWN pin.

SELECTING EXTERNAL COMPONENTS

Input Capacitor Value Selection

Two quantities determine the value of the input coupling capacitor: the lowest audio frequency that requires amplification and desired output transient suppression.

As shown in Figure 1, the input resistor (R_i) and the input capacitor (C_i) produce a high pass filter cutoff frequency that is found using Equation (6).

$$f_c = 1/2\pi R_i C_i \quad (6)$$

As an example when using a speaker with a low frequency limit of 50Hz, C_i using Equation (6) is 0.159 μ F. The 0.39 μ F C_{INA} shown in Figure 1 allows the LM4951 to drive high efficiency, full range speaker whose response extends below 30Hz.

Selecting Value For R_c

The LM4951 is designed for very fast turn on time. The Cchg pin allows the input capacitors (C_{inA} and C_{inB}) to charge quickly to improve click/pop performance. Rchg1 and Rchg2 protect the Cchg pins from any over/under voltage conditions caused by excessive input signal or an active input signal when the device is in shutdown. The recommended value for Rchg1 and Rchg2 is 1k Ω . If the input signal is less than $V_{\text{DD}} + 0.3\text{V}$ and greater than -0.3V , and if the input signal is disabled when in shutdown mode, Rchg1 and Rchg2 may be shorted out.

OPTIMIZING CLICK AND POP REDUCTION PERFORMANCE

The LM4951 contains circuitry that eliminates turn-on and shutdown transients ("clicks and pops"). For this discussion,

turn-on refers to either applying the power supply voltage or when the micro-power shutdown mode is deactivated.

As the $V_{\text{DD}}/2$ voltage present at the BYPASS pin ramps to its final value, the LM4951's internal amplifiers are configured as unity gain buffers. An internal current source charges the capacitor connected between the BYPASS pin and GND in a controlled manner. Ideally, the input and outputs track the voltage applied to the BYPASS pin.

The gain of the internal amplifiers remains unity until the voltage on the bypass pin reaches $V_{\text{DD}}/2$. As soon as the voltage on the bypass pin is stable, there is a delay to prevent undesirable output transients ("click and pops"). After this delay, the device becomes fully functional.

AUDIO POWER AMPLIFIER DESIGN

Audio Amplifier Design: Driving 1.8W into an 8 Ω BTL

The following are the desired operational parameters:

Power Output	1.8W _{RMS}
Load Impedance	8 Ω
Input Level	0.3V _{RMS} (max)
Input Impedance	20k Ω
Bandwidth	50Hz–20kHz \pm 0.25dB

The design begins by specifying the minimum supply voltage necessary to obtain the specified output power. One way to find the minimum supply voltage is to use the *Output Power vs Power Supply Voltage* curve in the **Typical Performance Characteristics** section. Another way, using Equation (7), is to calculate the peak output voltage necessary to achieve the desired output power for a given load impedance. To account for the amplifier's dropout voltage, two additional voltages, based on the *Clipping Dropout Voltage vs Power Supply Voltage* in the **Typical Performance Characteristics** curves, must be added to the result obtained by Equation (7). The result is Equation (8).

$$V_{\text{opeak}} = \sqrt{2R_L P_O} \quad (7)$$

$$V_{\text{DD}} = V_{\text{OUTPEAK}} + V_{\text{ODTOP}} + V_{\text{ODBOT}} \quad (8)$$

The commonly used 7.5V supply voltage easily meets this. The additional voltage creates the benefit of headroom, allowing the LM4951 to produce peak output power in excess of 1.8W without clipping or other audible distortion. The choice of supply voltage must also not create a situation that violates of maximum power dissipation as explained above in the Power Dissipation section. After satisfying the LM4951's power dissipation requirements, the minimum differential gain needed to achieve 1.8W dissipation in an 8 Ω BTL load is found using Equation (9).

$$A_V \geq \sqrt{(P_O R_L)} / (V_{\text{IN}}) = V_{\text{orms}} / V_{\text{inrms}} \quad (9)$$

Thus, a minimum gain of 12.6 allows the LM4951's to reach full output swing and maintain low noise and THD+N performance. For this example, let $A_{\text{V-BTL}} = 13$. The amplifier's overall BTL gain is set using the input (R_i) and feedback (R_f) resistors of the first amplifier in the series BTL configuration. Additionally, $A_{\text{V-BTL}}$ is twice the gain set by the first amplifier's

R_i and R_f . With the desired input impedance set at $20k\Omega$, the feedback resistor is found using Equation (10).

$$R_f / R_i = A_{V-BTL} / 2 \quad (10)$$

The value of R_f is $130k\Omega$ (choose $191k\Omega$, the closest value). The nominal output power is $1.8W$.

The last step in this design example is setting the amplifier's -3dB frequency bandwidth. To achieve the desired $\pm 0.25dB$ pass band magnitude variation limit, the low frequency response must extend to at least one-fifth the lower bandwidth limit and the high frequency response must extend to at least five times the upper bandwidth limit. The gain variation for both response limits is $0.17dB$, well within the $\pm 0.25dB$ -desired limit. The results are an

$$f_L = 50Hz / 5 = 10Hz \quad (11)$$

and an

$$f_H = 20kHz \times 5 = 100kHz \quad (12)$$

As mentioned in the **SELECTING EXTERNAL COMPONENTS** section, R_i and C_i create a highpass filter that sets the amplifier's lower bandpass frequency limit. Find the coupling capacitor's value using Equation (13).

$$C_i = 1 / 2\pi R_i f_L \quad (13)$$

The result is

$$1 / (2\pi \times 20k\Omega \times 10Hz) = 0.795\mu F$$

Use a $0.82\mu F$ capacitor, the closest standard value.

The product of the desired high frequency cutoff ($100kHz$ in this example) and the differential gain A_{VD} , determines the upper passband response limit. With $A_{VD} = 7$ and $f_H = 100kHz$, the closed-loop gain bandwidth product (GBWP) is $700kHz$. This is less than the LM4951's $3.5MHz$ GBWP. With this margin, the amplifier can be used in designs that require more differential gain while avoiding performance restricting bandwidth limitations.

RECOMMENDED PRINTED CIRCUIT BOARD LAYOUT

Figures 2–4 show the recommended two-layer PC board layout that is optimized for the SD10A. This circuit is designed for use with an external $7.5V$ supply 8Ω (min) speakers.

These circuit boards are easy to use. Apply $7.5V$ and ground to the board's V_{DD} and GND pads, respectively. Connect a speaker between the board's OUT_A and OUT_B outputs.

Demonstration Board Layout

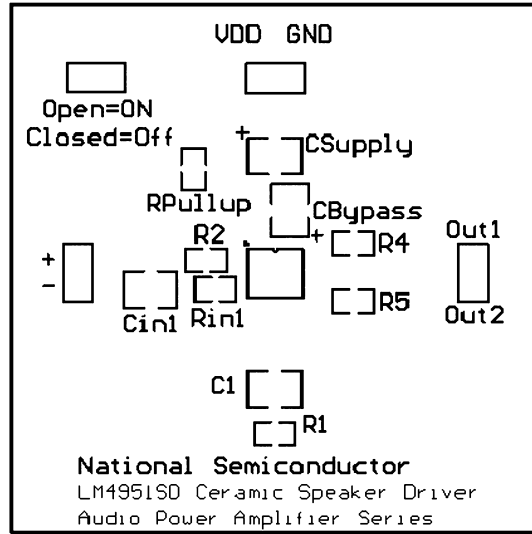

20094218

FIGURE 2. Recommended TS SE PCB Layout:
Top Silkscreen

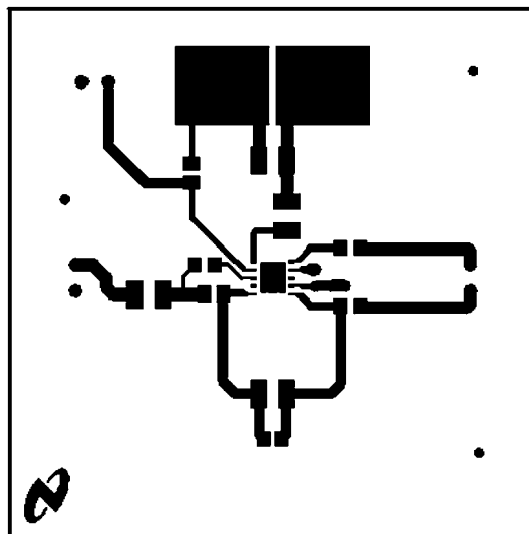

20094217

FIGURE 3. Recommended TS SE PCB Layout:
Top Layer

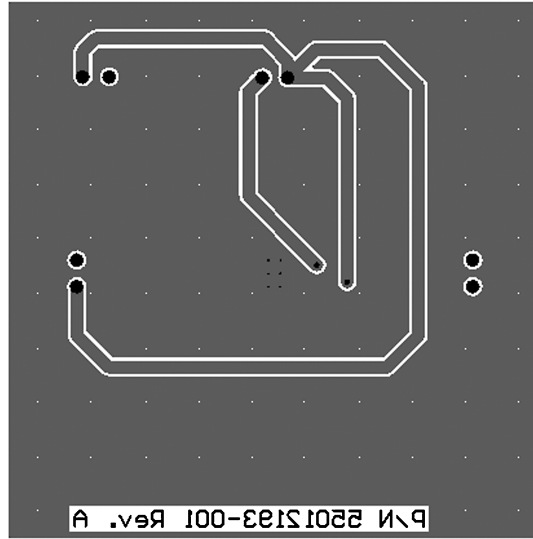

20094216

**FIGURE 4. Recommended TS SE PCB Layout:
Bottom Layer**

Revision History

Rev	Date	Description
1.0	8/25/04	Initial WEB.
1.1	10/19/05	Added the micro SMD pkg, then WEB.
1.2	08/30/06	Added the Limit value (=35) on the Twu (7.5V Elect Char table), then WEB.
1.3	09/11/06	Added the "Selecting Value For Rc, then WEB.
1.4	05/21/07	Fixed a typo (X3 value = 0.600±0.075) instead of (X3 = 0.600±0.75).
1.5	03/18/09	Text edits.

Physical Dimensions inches (millimeters) unless otherwise noted

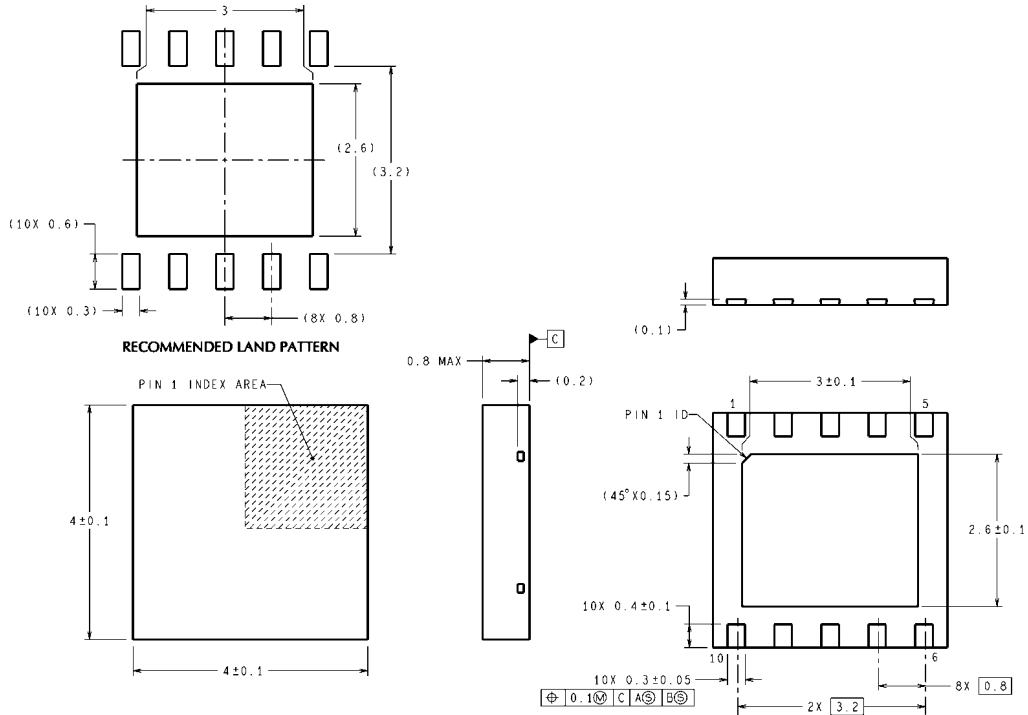

DIMENSIONS ARE IN MILLIMETERS

SDC10A (Rev A)

Order Number LM4951SD
NS Package Number SDC10A

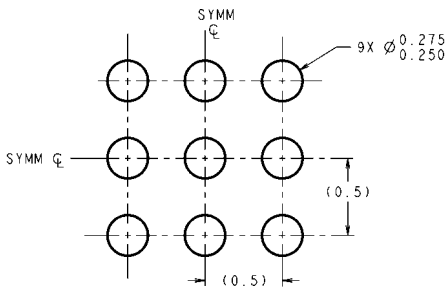

DIMENSIONS ARE IN MILLIMETERS
DIMENSIONS IN () FOR REFERENCE ONLY

LAND PATTERN RECOMMENDATION

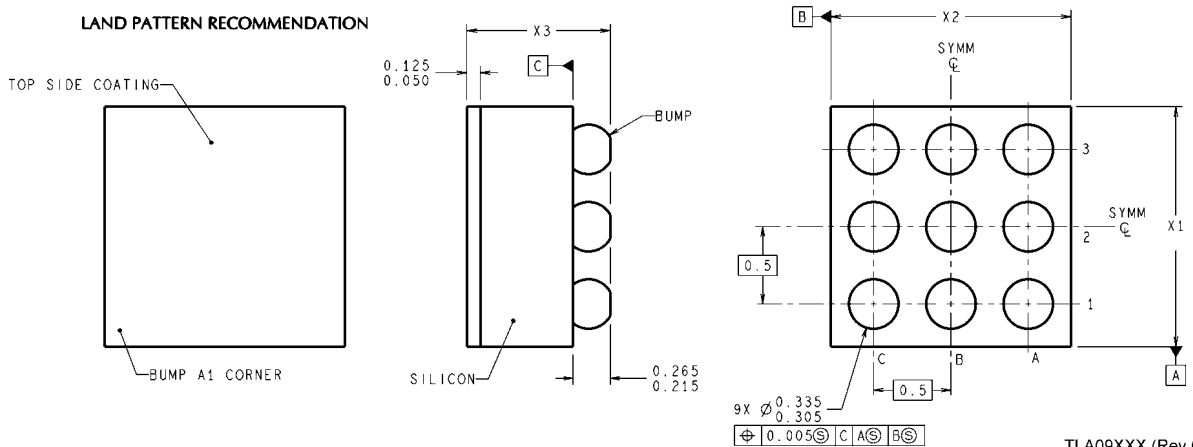

Order Number LM4951TL, TLX
NS Package Number TLA09ZZA
 $X_1 = 1.463 \pm 0.03$, $X_2 = 1.463 \pm 0.03$, $X_3 = 0.600 \pm 0.075$

TLA09XXX (Rev C)

Notes

LM4951

Notes

For more National Semiconductor product information and proven design tools, visit the following Web sites at:

Products		Design Support	
Amplifiers	www.national.com/amplifiers	WEBENCH® Tools	www.national.com/webench
Audio	www.national.com/audio	App Notes	www.national.com/appnotes
Clock and Timing	www.national.com/timing	Reference Designs	www.national.com/refdesigns
Data Converters	www.national.com/adc	Samples	www.national.com/samples
Interface	www.national.com/interface	Eval Boards	www.national.com/evalboards
LVDS	www.national.com/lvds	Packaging	www.national.com/packaging
Power Management	www.national.com/power	Green Compliance	www.national.com/quality/green
Switching Regulators	www.national.com/switchers	Distributors	www.national.com/contacts
LDOs	www.national.com/ldo	Quality and Reliability	www.national.com/quality
LED Lighting	www.national.com/led	Feedback/Support	www.national.com/feedback
Voltage Reference	www.national.com/vref	Design Made Easy	www.national.com/easy
PowerWise® Solutions	www.national.com/powerwise	Solutions	www.national.com/solutions
Serial Digital Interface (SDI)	www.national.com/sdi	Mil/Aero	www.national.com/milaero
Temperature Sensors	www.national.com/tempsensors	SolarMagic™	www.national.com/solarmagic
Wireless (PLL/VCO)	www.national.com/wireless	Analog University®	www.national.com/AU

THE CONTENTS OF THIS DOCUMENT ARE PROVIDED IN CONNECTION WITH NATIONAL SEMICONDUCTOR CORPORATION ("NATIONAL") PRODUCTS. NATIONAL MAKES NO REPRESENTATIONS OR WARRANTIES WITH RESPECT TO THE ACCURACY OR COMPLETENESS OF THE CONTENTS OF THIS PUBLICATION AND RESERVES THE RIGHT TO MAKE CHANGES TO SPECIFICATIONS AND PRODUCT DESCRIPTIONS AT ANY TIME WITHOUT NOTICE. NO LICENSE, WHETHER EXPRESS, IMPLIED, ARISING BY ESTOPPEL OR OTHERWISE, TO ANY INTELLECTUAL PROPERTY RIGHTS IS GRANTED BY THIS DOCUMENT.

TESTING AND OTHER QUALITY CONTROLS ARE USED TO THE EXTENT NATIONAL DEEMS NECESSARY TO SUPPORT NATIONAL'S PRODUCT WARRANTY. EXCEPT WHERE MANDATED BY GOVERNMENT REQUIREMENTS, TESTING OF ALL PARAMETERS OF EACH PRODUCT IS NOT NECESSARILY PERFORMED. NATIONAL ASSUMES NO LIABILITY FOR APPLICATIONS ASSISTANCE OR BUYER PRODUCT DESIGN. BUYERS ARE RESPONSIBLE FOR THEIR PRODUCTS AND APPLICATIONS USING NATIONAL COMPONENTS. PRIOR TO USING OR DISTRIBUTING ANY PRODUCTS THAT INCLUDE NATIONAL COMPONENTS, BUYERS SHOULD PROVIDE ADEQUATE DESIGN, TESTING AND OPERATING SAFEGUARDS.

EXCEPT AS PROVIDED IN NATIONAL'S TERMS AND CONDITIONS OF SALE FOR SUCH PRODUCTS, NATIONAL ASSUMES NO LIABILITY WHATSOEVER, AND NATIONAL DISCLAIMS ANY EXPRESS OR IMPLIED WARRANTY RELATING TO THE SALE AND/OR USE OF NATIONAL PRODUCTS INCLUDING LIABILITY OR WARRANTIES RELATING TO FITNESS FOR A PARTICULAR PURPOSE, MERCHANTABILITY, OR INFRINGEMENT OF ANY PATENT, COPYRIGHT OR OTHER INTELLECTUAL PROPERTY RIGHT.

LIFE SUPPORT POLICY

NATIONAL'S PRODUCTS ARE NOT AUTHORIZED FOR USE AS CRITICAL COMPONENTS IN LIFE SUPPORT DEVICES OR SYSTEMS WITHOUT THE EXPRESS PRIOR WRITTEN APPROVAL OF THE CHIEF EXECUTIVE OFFICER AND GENERAL COUNSEL OF NATIONAL SEMICONDUCTOR CORPORATION. As used herein:

Life support devices or systems are devices which (a) are intended for surgical implant into the body, or (b) support or sustain life and whose failure to perform when properly used in accordance with instructions for use provided in the labeling can be reasonably expected to result in a significant injury to the user. A critical component is any component in a life support device or system whose failure to perform can be reasonably expected to cause the failure of the life support device or system or to affect its safety or effectiveness.

National Semiconductor and the National Semiconductor logo are registered trademarks of National Semiconductor Corporation. All other brand or product names may be trademarks or registered trademarks of their respective holders.

Copyright© 2009 National Semiconductor Corporation

For the most current product information visit us at www.national.com



**National Semiconductor
Americas Technical
Support Center**
Email: support@nsc.com
Tel: 1-800-272-9959

**National Semiconductor Europe
Technical Support Center**
Email: europe.support@nsc.com

**National Semiconductor Asia
Pacific Technical Support Center**
Email: ap.support@nsc.com

**National Semiconductor Japan
Technical Support Center**
Email: jpn.feedback@nsc.com