

LM4898 Boomer® Audio Power Amplifier Series

1 Watt Fully Differential Audio Power Amplifier With Shutdown Select

General Description

The LM4898 is a fully differential audio power amplifier primarily designed for demanding applications in mobile phones and other portable communication device applications. It is capable of delivering 1 watt of continuous average power to an 8Ω BTL load with less than 1% distortion (THD+N) from a 5V_{DC} power supply.

Boomer audio power amplifiers were designed specifically to provide high quality output power with a minimal amount of external components. The LM4898 does not require output coupling capacitors or bootstrap capacitors, and therefore is ideally suited for mobile phone and other low voltage applications where minimal power consumption is a primary requirement.

The LM4898 features a low-power consumption shutdown mode. To facilitate this, Shutdown may be enabled by either logic high or low depending on mode selection. Driving the shutdown mode pin either high or low enables the shutdown select pin to be driven in a likewise manner to enable Shutdown. Additionally, the LM4898 features an internal thermal shutdown protection mechanism.

The LM4898 contains advanced pop & click circuitry which virtually eliminates noises which would otherwise occur during turn-on and turn-off transitions.

Key Specifications

■ Improved PSRR at 217Hz	83dB(typ)
■ Power Output at 5.0V & 1% THD	1.0W(typ)
■ Power Output at 3.3V & 1% THD	400mW(typ)
■ Shutdown Current	0.1µA(typ)

Features

- Fully differential amplification
- Available in space-saving packages micro SMD, MSOP, and LLP
- Ultra low current shutdown mode
- Can drive capacitive loads up to 500pF
- Improved pop & click circuitry eliminates noises during turn-on and turn-off transitions
- 2.4 - 5.5V operation
- No output coupling capacitors, snubber networks or bootstrap capacitors required
- Shutdown high or low selectivity

Applications

- Mobile phones
- PDAs
- Portable electronic devices

Connection Diagrams

Mini Small Outline (MSOP) Package

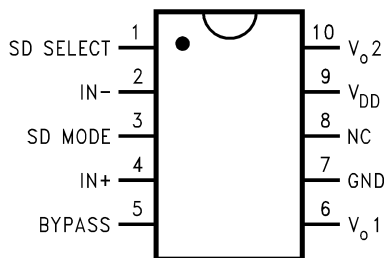

20073723

Top View

Order Number LM4898MM
See NS Package Number MUB10A

MSOP Marking



20073774

Z - Assembly Code
X - Date Code
TT - Die Run Traceability
G - Boomer Family
B3 - LM4898MM

Boomer® is a registered trademark of National Semiconductor Corporation.

Connection Diagrams (Continued)

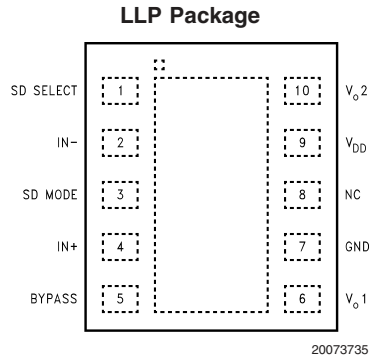

Top View
Order Number LM4898LD
See NS Package Number LDA10B

LD Marking

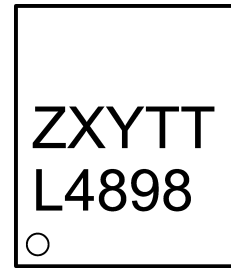

20073756
Z - Assembly Code
XY - Date Code
TT - Die Run Traceability
L4898 - LM4898LD

9 Bump micro SMD Package

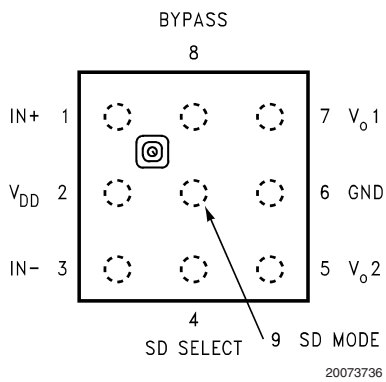

Top View
Order Number LM4898ITL, LM4898ITLX
See NS Package Number TLA09AAA

9 Bump micro SMD Marking

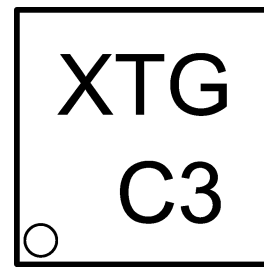

20073784
X - Date Code
T - Die Run Traceability
G - Boomer Family
C3 - LM4898ITLX

Typical Application

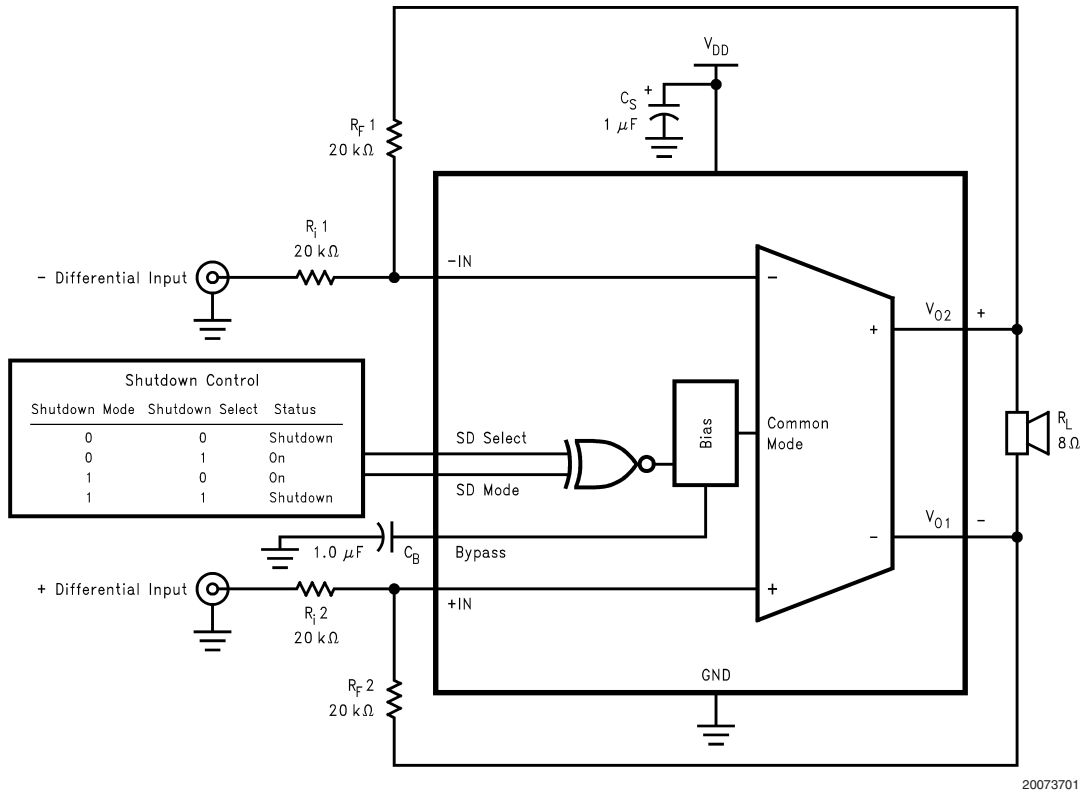

FIGURE 1. Typical Audio Amplifier Application Circuit

Absolute Maximum Ratings (Note 2)

If Military/Aerospace specified devices are required, please contact the National Semiconductor Sales Office/Distributors for availability and specifications.

Supply Voltage	6.0V
Storage Temperature	-65°C to +150°C
Input Voltage	-0.3V to $V_{DD} + 0.3V$
Power Dissipation (Note 3)	Internally Limited
ESD Susceptibility (Note 4)	2000V
ESD Susceptibility (Note 5)	200V
Junction Temperature	150°C
Thermal Resistance	
θ_{JC} (LLP)	12°C/W

θ_{JA} (LLP)	63°C/W
θ_{JA} (micro SMD)	220°C/W
θ_{JC} (MSOP)	56°C/W
θ_{JA} (MSOP)	190°C/W

Soldering Information

See AN-1112 "microSMD Wafers Level Chip Scale Package."

Operating Ratings**Temperature Range**

$$T_{MIN} \leq T_A \leq T_{MAX}$$

$$-40^\circ\text{C} \leq T_A \leq 85^\circ\text{C}$$

Supply Voltage

$$2.4V \leq V_{DD} \leq 5.5V$$

Electrical Characteristics $V_{DD} = 5V$ (Notes 1, 2, 8) The following specifications apply for $V_{DD} = 5V$, 8Ω load, and $A_V = 1V/V$, unless otherwise specified. Limits apply for $T_A = 25^\circ\text{C}$.

Symbol	Parameter	Conditions	LM4898		Units (Limits)
			Typical	Limit	
			(Note 6)	(Note 7)	
I_{DD}	Quiescent Power Supply Current	$V_{IN} = 0V$, no load	3	6	mA (max)
		$V_{IN} = 0V$, $R_L = 8\Omega$	5	10	
I_{SD}	Shutdown Current	$V_{SDMODE} = V_{SHUTDOWN} = GND$	0.1	1	μA (max)
P_o	Output Power	THD = 1% (max); $f = 1\text{ kHz}$			
		LM4898LD, $R_L = 4\Omega$ (Note 11)	1.4		W (min)
		LM4898, $R_L = 8\Omega$	1	0.9	
THD+N	Total Harmonic Distortion+Noise	$P_o = 0.4\text{ Wrms}$; $f = 1\text{ kHz}$	0.05		%
PSRR	Power Supply Rejection Ratio	$V_{ripple} = 200\text{mV}$ sine p-p			dB (min)
		$f = 217\text{Hz}$ (Note 9)	83		
		$f = 1\text{kHz}$ (Note 9)	90		
		$f = 217\text{Hz}$ (Note 10)	83	71	
CMRR	Common_Mode Rejection Ratio	$f = 217\text{Hz}$	50		dB
		$V_{CM} = 200\text{mV}_{DD}$			
V_{OS}	Output Offset	$V_{IN} = 0V$	2		mV
V_{SDIH}	Shutdown Voltage Input High	SD Mode = GND	0.9		V
V_{SDIL}	Shutdown Voltage Input Low	SD Mode = GND	0.7		V
V_{SDIH}	Shutdown Voltage Input High	SD Mode = V_{DD}	0.9		V
V_{SDIL}	Shutdown Voltage Input Low	SD Mode = V_{DD}	0.7		V

Electrical Characteristics $V_{DD} = 3V$ (Notes 1, 2, 8)

The following specifications apply for $V_{DD} = 3V$, 8Ω load and $A_V = 1V/V$, unless otherwise specified. Limits apply for $T_A = 25^\circ C$.

Symbol	Parameter	Conditions	LM4898		Units (Limits)
			Typical	Limit	
			(Note 6)	(Note 7)	
I_{DD}	Quiescent Power Supply Current	$V_{IN} = 0V$, no load	2.5	5.5	mA (max)
		$V_{IN} = 0V$, $R_L = 8\Omega$	4	9	
I_{SD}	Shutdown Current	$V_{SDMODE} = V_{SHUTDOWN} = GND$	0.1	1	μA (max)
P_o	Output Power	THD = 1% (max); $f = 1kHz$ LM4898, $R_L = 8\Omega$	0.35		W
THD+N	Total Harmonic Distortion+Noise	$P_o = 0.25W_{rms}$; $f = 1kHz$	0.03		%
PSRR	Power Supply Rejection Ratio	$V_{ripple} = 200mV$ sine p-p			dB
		$f = 217Hz$ (Note 9)	83		
		$f = 1kHz$ (Note 9)	84		
		$f = 217Hz$ (Note 10)	83		
CMRR	Common-Mode Rejection Ratio	$f = 217Hz$	50		dB
		$V_{CM} = 200mV_{PP}$			
V_{OS}	Output Offset	$V_{IN} = 0V$	2		mV
V_{SDIH}	Shutdown Voltage Input High	SD Mode = GND	0.8		V
V_{SDIL}	Shutdown Voltage Input Low	SD Mode = GND	0.6		V
V_{SDIH}	Shutdown Voltage Input High	SD Mode = V_{DD}	0.8		V
V_{SDIL}	Shutdown Voltage Input Low	SD Mode = V_{DD}	0.6		V

Note 1: All voltages are measured with respect to the ground pin, unless otherwise specified.

Note 2: *Absolute Maximum Ratings* indicate limits beyond which damage to the device may occur. *Operating Ratings* indicate conditions for which the device is functional, but do not guarantee specific performance limits. *Electrical Characteristics* state DC and AC electrical specifications under particular test conditions which guarantee specific performance limits. This assumes that the device is within the Operating Ratings. Specifications are not guaranteed for parameters where no limit is given, however, the typical value is a good indication of device performance.

Note 3: The maximum power dissipation must be derated at elevated temperatures and is dictated by T_{JMAX} , θ_{JA} , and the ambient temperature T_A . The maximum allowable power dissipation is $P_{DMAX} = (T_{JMAX} - T_A)/\theta_{JA}$ or the number given in Absolute Maximum Ratings, whichever is lower.

Note 4: Human body model, 100pF discharged through a 1.5k Ω resistor.

Note 5: Machine Model, 220pF–240pF discharged through all pins.

Note 6: Typicals are measured at 25°C and represent the parametric norm.

Note 7: Datasheet min/max specification limits are guaranteed by design, test, or statistical analysis.

Note 8: For micro SMD only, shutdown current is measured in a Normal Room Environment. Exposure to direct sunlight will increase I_{SD} by a maximum of 2 μA .

Note 9: Unterminated input.

Note 10: 10 Ω terminated input.

Note 11: When driving 4 Ω loads from a 5V supply, the LM4898LD must be mounted to a circuit board with the exposed-DAP area soldered down to a 1sq. in. plane of 1oz. copper..

External Components Description

(Figure 1)

Components	Functional Description
1. C_S	Supply bypass capacitor which provides power supply filtering. Refer to the Power Supply Bypassing section for information concerning proper placement and selection of the supply bypass capacitor.
2. C_B	Bypass pin capacitor which provides half-supply filtering. Refer to the section, Proper Selection of External Components , for information concerning proper placement and selection of C_B .
3. R_i	Inverting input resistance which sets the closed-loop gain in conjunction with R_f .
4. R_f	Feedback resistance which sets the closed-loop gain in conjunction with R_i .

Typical Performance Characteristics LD Specific Characteristics

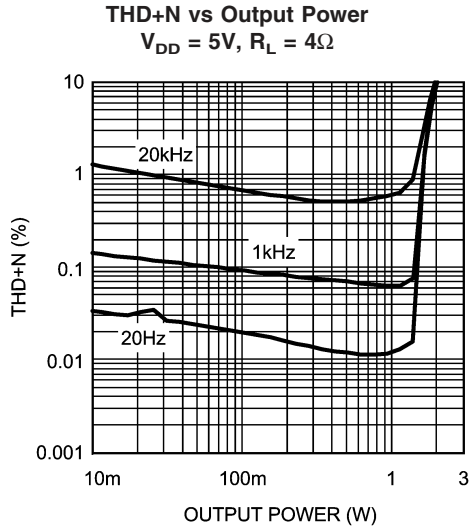

200737A1

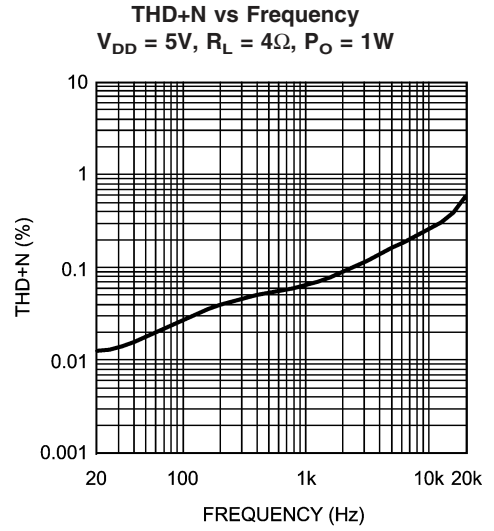

200737A3

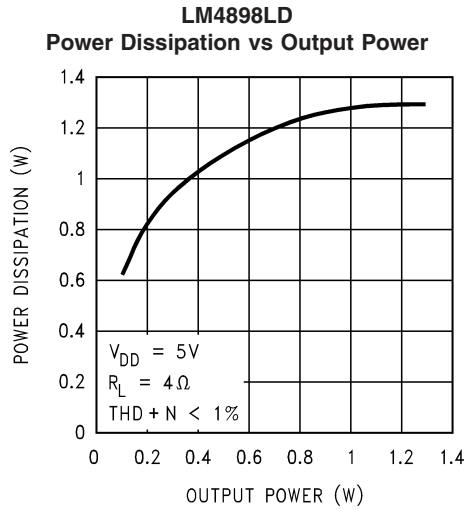

200737A4

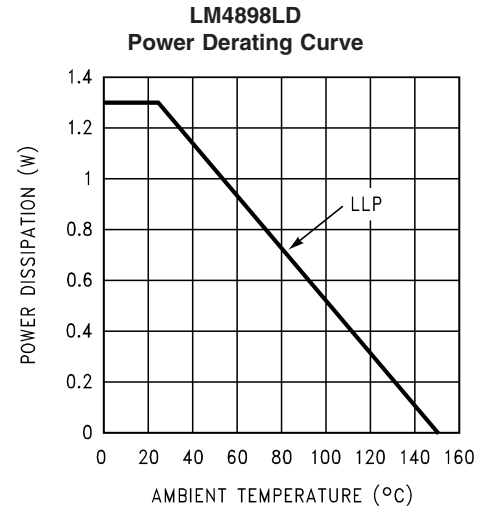

200737A5

Typical Performance Characteristics

Non-LD Specific Characteristics

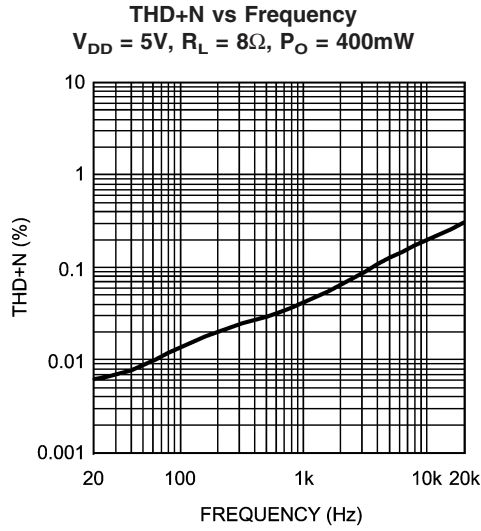

200737A7

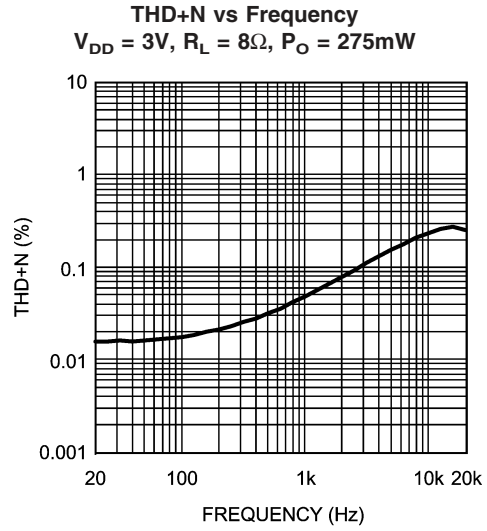

200737A9

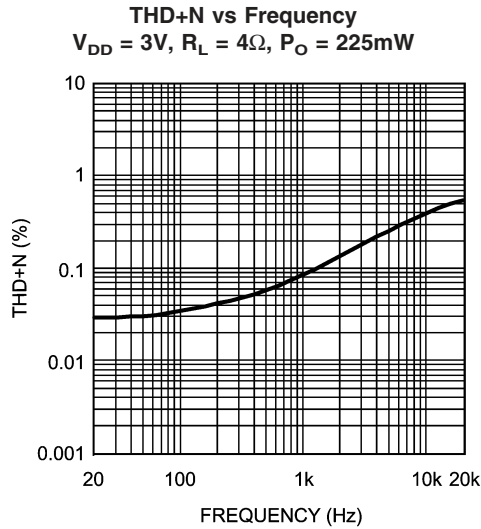

200737B1

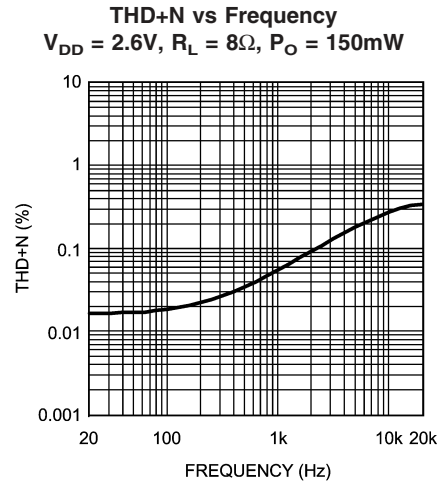

200737B3

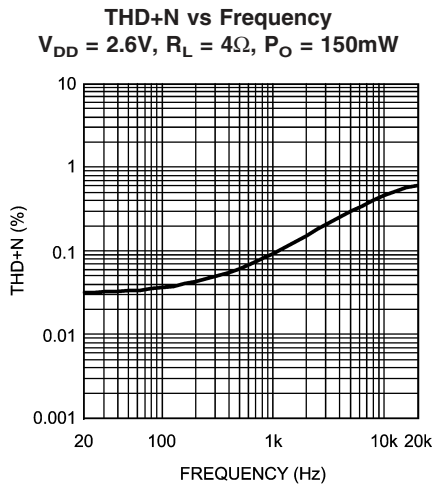

200737B5

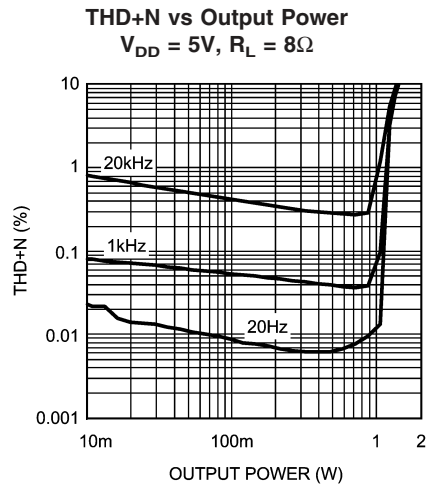

200737B7

Typical Performance Characteristics

Non-LD Specific Characteristics (Continued)

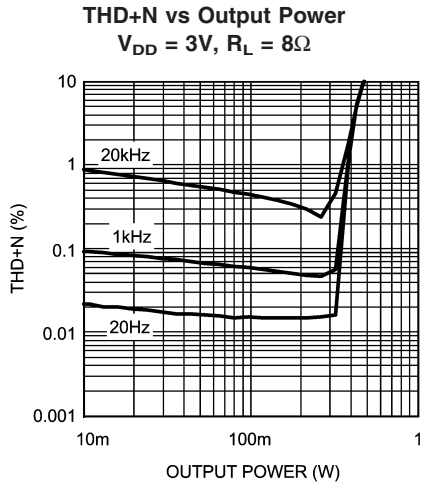

200737B9

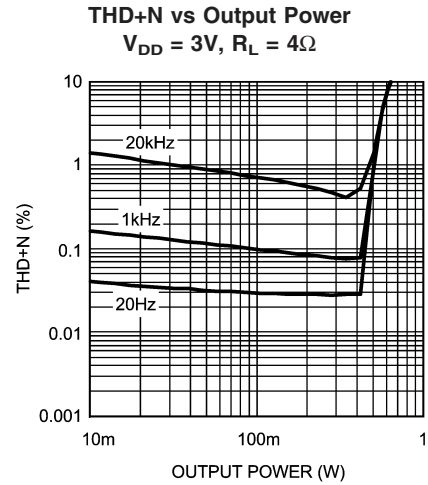

200737C1

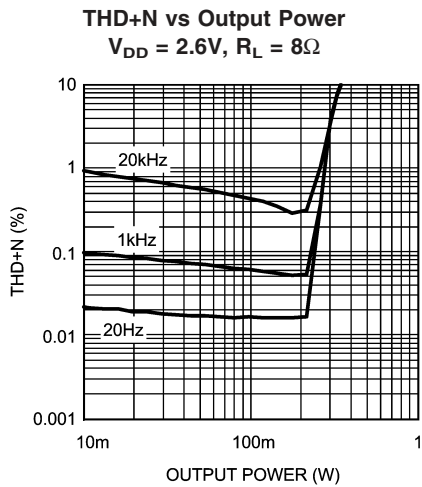

200737C3

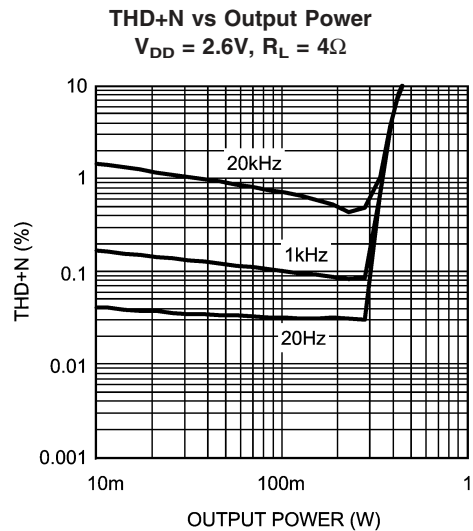

200737C5

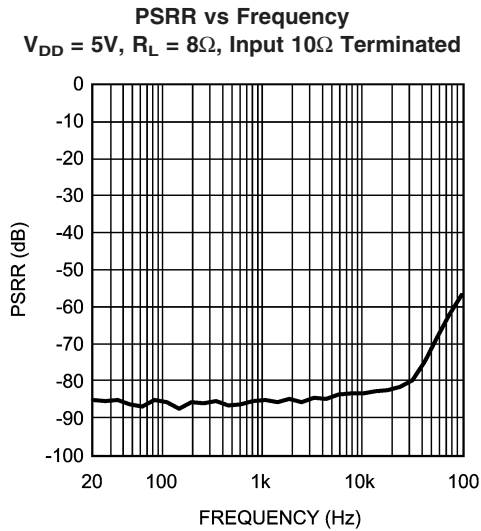

200737C7

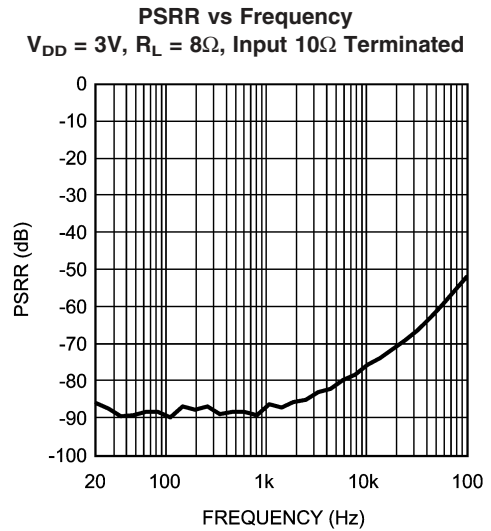

200737D0

Typical Performance Characteristics

Non-LD Specific Characteristics (Continued)

Output Power vs Supply Voltage
 $R_L = 8\Omega$

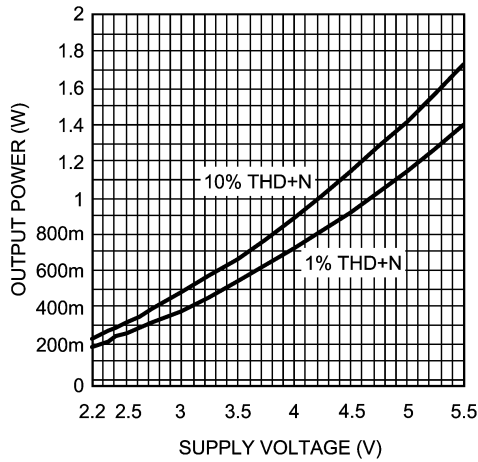

Output Power vs Supply Voltage
 $R_L = 4\Omega$

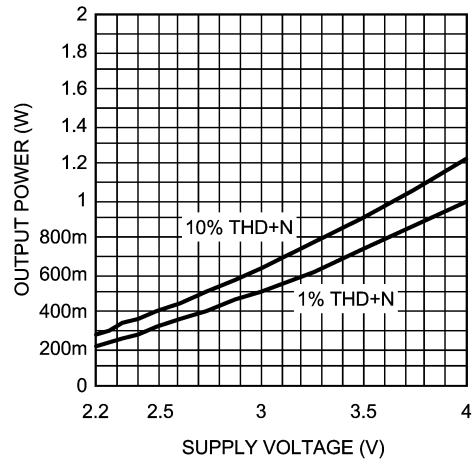

Power Dissipation vs Output Power

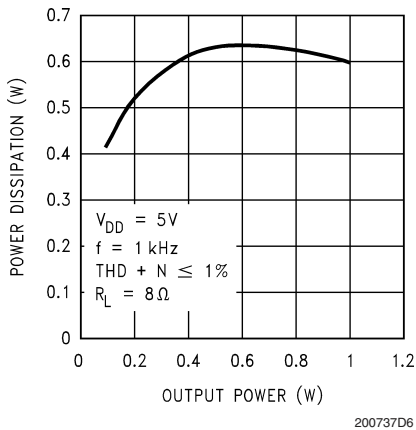

Power Dissipation vs Output Power

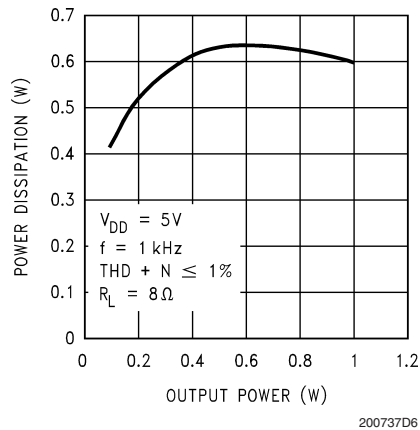

Power Dissipation vs Output Power

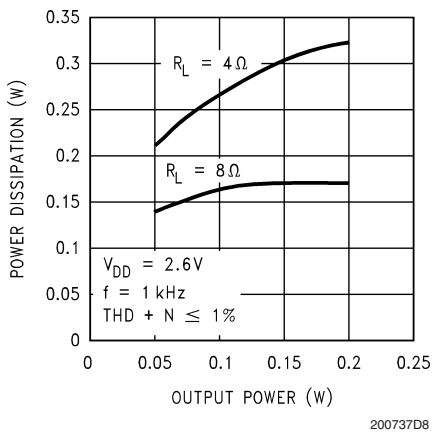

Output Power vs Load Resistance

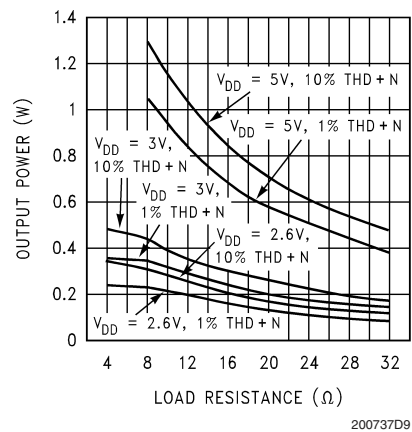

Typical Performance Characteristics

Non-LD Specific Characteristics (Continued)

Supply Current vs Shutdown Voltage
Shutdown Low

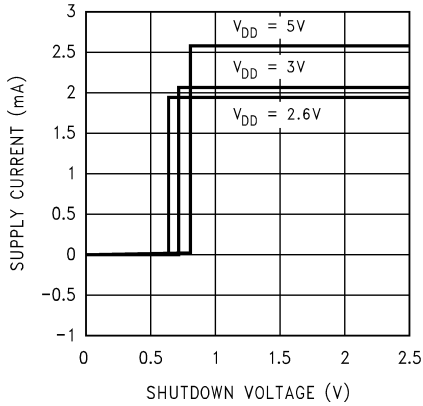

200737E0

Supply Current vs Shutdown Voltage
Shutdown High

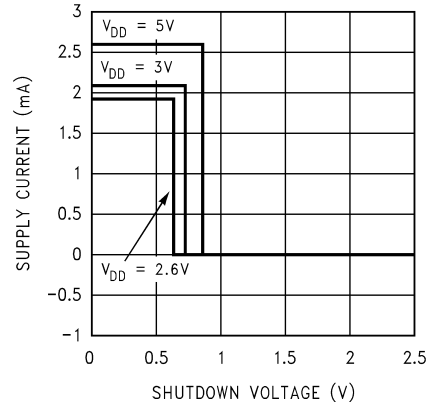

200737E1

Clipping (Dropout) Voltage vs Supply Voltage

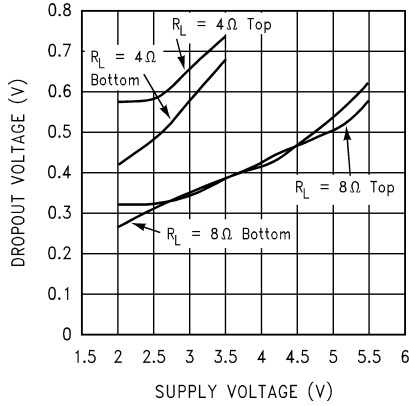

200737E2

Open Loop Frequency Response

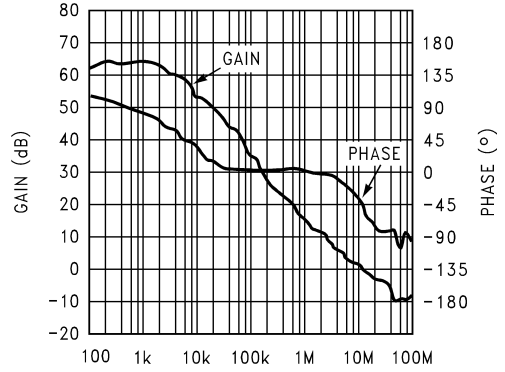

200737E3

Power Derating Curve

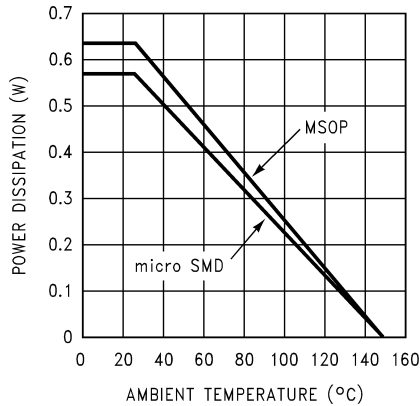

200737E4

Noise Floor

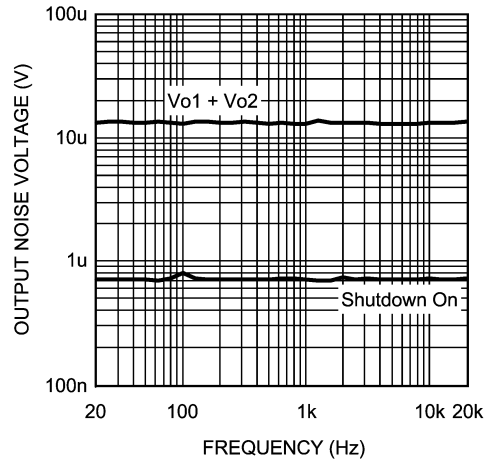

200737E6

Typical Performance Characteristics

Non-LD Specific Characteristics (Continued)

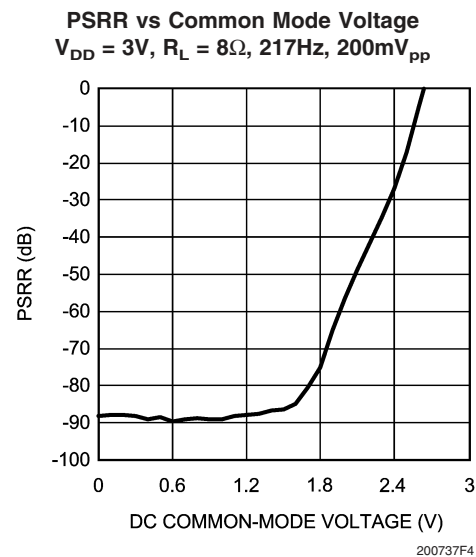
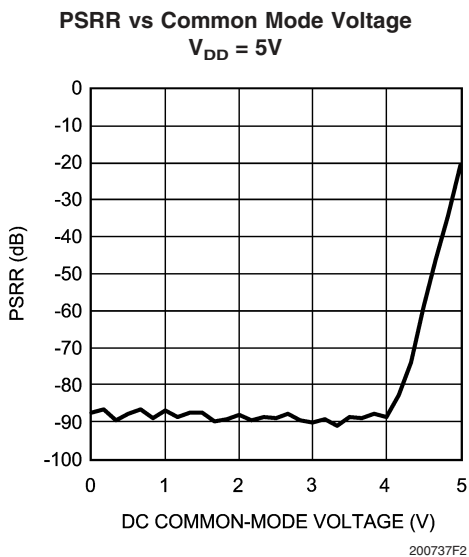
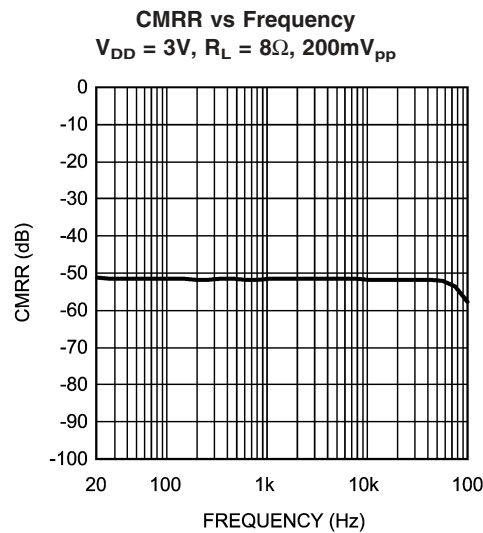
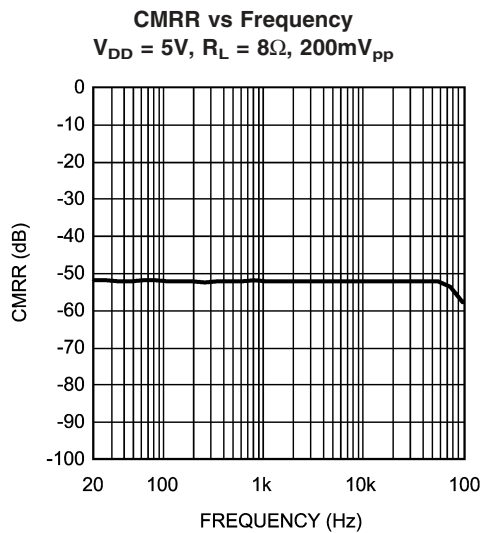

Application Information

DIFFERENTIAL AMPLIFIER EXPLANATION

The LM4898 is a fully differential audio amplifier that features differential input and output stages. Internally this is accomplished by two circuits: a differential amplifier and a common mode feedback amplifier that adjusts the output voltages so that the average value remains $V_{DD}/2$. When setting the differential gain, the amplifier can be considered to have two "halves". Each half uses an input and feedback resistor (R_{i1} and R_{f1}) to set its respective closed-loop gain (see Figure 1). With $R_{i1} = R_{i2}$ and $R_{f1} = R_{f2}$, the gain is set at $-R_{f1}/R_{i1}$ for each half. This results in a differential gain of

$$A_{VD} = -R_f/R_i \quad (1)$$

It is extremely important to match the input resistors to each other, as well as the feedback resistors to each other for best amplifier performance. See the Proper Selection of External Components section for more information. A differential amplifier works in a manner where the difference between the

two input signals is amplified. In most applications, this would require input signals that are 180° out of phase with each other. The LM4898 can be used, however, as a single ended input amplifier while still retaining its fully differential benefits. In fact, completely unrelated signals may be placed on the input pins. The LM4898 simply amplifies the difference between them.

All of these applications, either single-ended or fully differential, provide what is known as a "bridged mode" output (bridge-tied-load, BTL). This results in output signals at V_{o1} and V_{o2} that are 180° out of phase with respect to each other. Bridged mode operation is different from the single-ended amplifier configuration that connects the load between the amplifier output and ground. A bridged amplifier design has distinct advantages over the single-ended configuration: it provides differential drive to the load, thus doubling maximum possible output swing for a specific supply voltage. Four times the output power is possible compared with a single-ended amplifier under the same conditions. This increase in attainable output power assumes that the

Application Information (Continued)

amplifier is not current limited or clipped. In order to choose an amplifier's closed-loop gain without causing excess clipping, please refer to the Audio Power Amplifier Design section.

A bridged configuration, such as the one used in the LM4898, also creates a second advantage over single-ended amplifiers. Since the differential outputs, Vo1 and Vo2, are biased at half-supply, no net DC voltage exists across the load. This assumes that the input resistor pair and the feedback resistor pair are properly matched (see Proper Selection of External Components). BTL configuration eliminates the output coupling capacitor required in single supply, single-ended amplifier configurations. If an output coupling capacitor is not used in a single-ended output configuration, the half-supply bias across the load would result in both increased internal IC power dissipation as well as permanent loudspeaker damage. Further advantages of bridged mode operation specific to fully differential amplifiers like the LM4898 include increased power supply rejection ratio, common-mode noise reduction, and click and pop reduction.

EXPOSED-DAP PACKAGE PCB MOUNTING CONSIDERATIONS

The LM4898's exposed-DAP (die attach paddle) package (LD) provides a low thermal resistance between the die and the PCB to which the part is mounted and soldered. This allows rapid heat transfer from the die to the surrounding PCB copper traces, ground plane and, finally, surrounding air. The result is a low voltage audio power amplifier that produces 1.4W at $\leq 1\%$ THD with a 4 Ω load. This high power is achieved through careful consideration of necessary thermal design. Failing to optimize thermal design may compromise the LM4898's high power performance and activate unwanted, though necessary, thermal shutdown protection. The LD package must have its DAP soldered to a copper pad on the PCB. The DAP's PCB copper pad is connected to a large plane of continuous unbroken copper. This plane forms a thermal mass and heat sink and radiation area. Place the heat sink area on either outside plane in the case of a two-sided PCB, or on an inner layer of a board with more than two layers. Connect the DAP copper pad to the inner layer or backside copper heat sink area with 4 (2x2) vias. The via diameter should be 0.012in - 0.013in with a 0.050in pitch. Ensure efficient thermal conductivity by plating through and solder-filling the vias.

Best thermal performance is achieved with the largest practical copper heat sink area. If the heatsink and amplifier share the same PCB layer, a nominal 2.5in² (min) area is necessary for 5V operation with a 4 Ω load. Heatsink areas not placed on the same PCB layer as the LM4898 should be 5in² (min) for the same supply voltage and load resistance. The last two area recommendations apply for 25°C ambient temperature. In all circumstances and conditions, the junction temperature must be held below 150°C to prevent activating the LM4898's thermal shutdown protection. The LM4898's power derating curve in the Typical Performance Characteristics shows the maximum power dissipation versus temperature. Further detailed and specific information concerning PCB layout, fabrication, and mounting an LLP package is available from National Semiconductor's package Engineering Group under application note AN-1187.

PCB LAYOUT AND SUPPLY REGULATION CONSIDERATIONS FOR DRIVING 3 Ω AND 4 Ω LOADS

Power dissipated by a load is a function of the voltage swing across the load and the load's impedance. As load impedance decreases, load dissipation becomes increasingly dependent on the interconnect (PCB trace and wire) resistance between the amplifier output pins and the load's connections. Residual trace resistance causes a voltage drop, which results in power dissipated in the trace and not in the load as desired. For example, 0.1 Ω trace resistance reduces the output power dissipated by a 4 Ω load from 1.4W to 1.37W. This problem of decreased load dissipation is exacerbated as load impedance decreases. Therefore, to maintain the highest load dissipation and widest output voltage swing, PCB traces that connect the output pins to a load must be as wide as possible.

Poor power supply regulation adversely affects maximum output power. A poorly regulated supply's output voltage decreases with increasing load current. Reduced supply voltage causes decreased headroom, output signal clipping, and reduced output power. Even with tightly regulated supplies, trace resistance creates the same effects as poor supply regulation. Therefore, making the power supply traces as wide as possible helps maintain full output voltage swing.

POWER DISSIPATION

Power dissipation is a major concern when designing a successful amplifier, whether the amplifier is bridged or single-ended. Equation 2 states the maximum power dissipation point for a single-ended amplifier operating at a given supply voltage and driving a specified output load.

$$P_{\text{DMAX}} = (V_{\text{DD}})^2 / (2\pi^2 R_L) \text{ Single-Ended} \quad (2)$$

However, a direct consequence of the increased power delivered to the load by a bridge amplifier is an increase in internal power dissipation versus a single-ended amplifier operating at the same conditions.

$$P_{\text{DMAX}} = 4 * (V_{\text{DD}})^2 / (2\pi^2 R_L) \text{ Bridge Mode} \quad (3)$$

Since the LM4898 has bridged outputs, the maximum internal power dissipation is 4 times that of a single-ended amplifier. Even with this substantial increase in power dissipation, the LM4898 does not require additional heatsinking under most operating conditions and output loading. From Equation 3, assuming a 5V power supply and an 8 Ω load, the maximum power dissipation point is 625mW. The maximum power dissipation point obtained from Equation 3 must not be greater than the power dissipation results from Equation 4:

$$P_{\text{DMAX}} = (T_{\text{JMAX}} - T_{\text{A}}) / \theta_{\text{JA}} \quad (4)$$

The LM4898's θ_{JA} in an MUA10A package is 190°C/W. Depending on the ambient temperature, T_{A} , of the system surroundings, Equation 4 can be used to find the maximum internal power dissipation supported by the IC packaging. If the result of Equation 3 is greater than that of Equation 4, then either the supply voltage must be decreased, the load impedance increased, the ambient temperature reduced, or the θ_{JA} reduced with heatsinking. In many cases, larger traces near the output, V_{DD} , and GND pins can be used to lower the θ_{JA} . The larger areas of copper provide a form of heatsinking allowing higher power dissipation. For the typical application of a 5V power supply, with an 8 Ω load, the maximum ambient temperature possible without violating the maximum junction temperature is approximately 30°C provided that device operation is around the maximum power dissipation point. Recall that internal power dissipation is a

Application Information (Continued)

function of output power. If typical operation is not around the maximum power dissipation point, the LM4898 can operate at higher ambient temperatures. Refer to the Typical Performance Characteristics curves for power dissipation information.

POWER SUPPLY BYPASSING

As with any power amplifier, proper supply bypassing is critical for low noise performance and high power supply rejection ratio (PSRR). The capacitor location on both the bypass and power supply pins should be as close to the device as possible. A larger half-supply bypass capacitor improves PSRR because it increases half-supply stability. Typical applications employ a 5V regulator with 10 μ F and 0.1 μ F bypass capacitors that increase supply stability. This, however, does not eliminate the need for bypassing the supply nodes of the LM4898. Although the LM4898 will operate without the bypass capacitor C_B , the PSRR may decrease. A 1 μ F capacitor is recommended for C_B . This value maximizes PSRR performance. Lesser values may be used, but PSRR decreases at frequencies below 1kHz. The issue of C_B selection is thus dependant upon desired PSRR and click and pop performance as explained in the section Proper Selection of External Components.

SHUTDOWN FUNCTION

In order to reduce power consumption while not in use, the LM4898 contains shutdown circuitry that is used to turn off the amplifier's bias circuitry. In addition, the LM4898 contains a Shutdown Mode pin, allowing the designer to designate whether the part will be driven into shutdown with a high level logic signal or a low level logic signal. This allows the designer maximum flexibility in device use, as the Shutdown Mode pin may simply be tied permanently to either V_{DD} or GND to set the LM4898 as either a "shutdown-high" device or a "shutdown-low" device, respectively. The device may then be placed into shutdown mode by toggling the Shutdown Select pin to the same state as the Shutdown Mode pin. For simplicity's sake, this is called "shutdown same", as the LM4898 enters shutdown mode whenever the two pins are in the same logic state. The trigger point for either shutdown high or shutdown low is shown as a typical value in the Supply Current vs. Shutdown Voltage graphs in the Typical Performance Characteristics section. It is best to switch between ground and supply for maximum performance. While the device may be disabled with shutdown voltages in between ground and supply, the idle current maybe greater than the typical value of 0.1 μ A. In either case, the shutdown pin should be tied to a definite voltage to avoid unwanted state changes.

In many applications, a microcontroller or microprocessor output is used to control the shutdown circuitry, which provides a quick, smooth transition to shutdown. Another solution is to use a single-throw switch in conjunction with an external pull-up resistor (or pull-down, depending on shutdown high or low application). This scheme guarantees that the shutdown pin will not float, thus preventing unwanted state changes.

PROPER SELECTION OF EXTERNAL COMPONENTS

Proper selection of external components in applications using integrated power amplifiers is critical when optimizing device and system performance. Although the LM4898 is tolerant to a variety of external component combinations, consideration of component values must be made when maximizing overall system quality.

The LM4898 is unity-gain stable, giving the designer maximum system flexibility. The LM4898 should be used in low closed-loop gain configurations to minimize THD+N values and maximize signal to noise ratio. Low gain configurations require large input signals to obtain a given output power. Input signals equal to or greater than 1V_{rms} are available from sources such as audio codecs. Please refer to the Audio Power Amplifier Design section for a more complete explanation of proper gain selection. When used in its typical application as a fully differential power amplifier the LM4898 does not require input coupling capacitors for input sources with DC common-mode voltages of less than V_{DD} . Exact allowable input common-mode voltage levels are actually a function of V_{DD} , R_i , and R_f and may be determined by Equation 5:

$$V_{CMI} < (V_{DD} - 1.2) * ((R_f + (R_i) / (R_i) - V_{DD} * (R_f / 2R_i)) \quad (5)$$

$$R_f / R_i = A_{VD} \quad (6)$$

Special care must be taken to match the values of the feedback resistors (R_{f1} and R_{f2}) to each other as well as matching the input resistors (R_{i1} and R_{i2}) to each other (see Figure 1). Because of the balanced nature of differential amplifiers, resistor matching differences can result in net DC currents across the load. This DC current can increase power consumption, internal IC power dissipation, reduce PSRR, and possibly damaging the loudspeaker. The chart below demonstrates this problem by showing the effects of differing values between the feedback resistors while assuming that the input resistors are perfectly matched. The results below apply to the application circuit shown in Figure 1, and assumes that $V_{DD} = 5V$, $R_L = 8\Omega$, and the system has DC coupled inputs tied to ground.

Tolerance	R_{f1}	R_{f2}	$V_{o2} - V_{o1}$	I_{LOAD}
20%	0.8R	1.2R	-0.5V	62.5mA
10%	0.9R	1.1R	-0.250V	31.25mA
5%	0.95R	1.05R	-0.125V	15.63mA
1%	0.99R	1.01R	-0.025V	3.125mA
0	R	R	R	0

Similar results would occur if the input resistors were not carefully matched. Adding input coupling capacitors in between the signal source and the input resistors will eliminate this problem, however, to achieve best performance with minimum component count it is highly recommended that both the feedback and input resistors matched to 1% tolerance or better.

Application Information (Continued)

AUDIO POWER AMPLIFIER DESIGN

Design a 1W/8Ω Audio Amplifier

Given:

- Power Output 1W
- Load Impedance 8Ω
- Input Level 1Vrms
- Input Impedance 20kΩ
- Bandwidth 100Hz–20kHz ± 0.25dB

A designer must first determine the minimum supply rail to obtain the specified output power. The supply rail can easily be found by extrapolating from the Output Power vs. Supply Voltage graphs in the Typical Performance Characteristics section. A second way to determine the minimum supply rail is to calculate the required V_{opeak} using Equation 7 and add the dropout voltages. Using this method, the minimum supply voltage is $(V_{\text{opeak}} + (V_{\text{DO TOP}} + (V_{\text{DO BOT}})))$, where $V_{\text{DO BOT}}$ and $V_{\text{DO TOP}}$ are extrapolated from the Dropout Voltage vs. Supply Voltage curve in the Typical Performance Characteristics section.

$$V_{\text{opeak}} = \sqrt{(2R_L P_O)} \quad (7)$$

Using the Output Power vs. Supply Voltage graph for an 8Ω load, the minimum supply rail just about 5V. Extra supply voltage creates headroom that allows the LM4898 to repro-

duce peaks in excess of 1W without producing audible distortion. At this time, the designer must make sure that the power supply choice along with the output impedance does not violate the conditions explained in the Power Dissipation section. Once the power dissipation equations have been addressed, the required differential gain can be determined from Equation 8.

$$A_{VD} \geq \sqrt{(P_O R_L)} / (V_{IN}) = V_{\text{orms}} / V_{\text{inrms}} \quad (8)$$

$$R_f / R_i = A_{VD}$$

From Equation 8, the minimum A_{VD} is 2.83. Since the desired input impedance was 20kΩ, a ratio of 2.83:1 of R_f to R_i results in an allocation of $R_i = 20\text{k}\Omega$ for both input resistors and $R_f = 60\text{k}\Omega$ for both feedback resistors. The final design step is to address the bandwidth requirement which must be stated as a single -3dB frequency point. Five times away from a -3dB point is 0.17dB down from passband response which is better than the required ±0.25dB specified.

$$f_H = 20\text{kHz} * 5 = 100\text{kHz}$$

The high frequency pole is determined by the product of the desired frequency pole, f_H , and the differential gain, A_{VD} . With a $A_{VD} = 2.83$ and $f_H = 100\text{kHz}$, the resulting GBWP = 150kHz which is much smaller than the LM4898 GBWP of 10MHz. This figure displays that if a designer has a need to design an amplifier with a higher differential gain, the LM4898 can still be used without running into bandwidth limitations.

Physical Dimensions inches (millimeters) unless otherwise noted

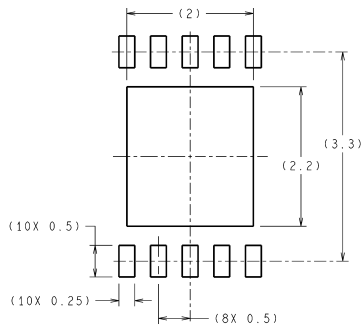

DIMENSIONS ARE IN MILLIMETERS
DIMENSIONS IN () FOR REFERENCE ONLY

RECOMMENDED LAND PATTERN
1:1 RATIO WITH PKG SOLDER PADS

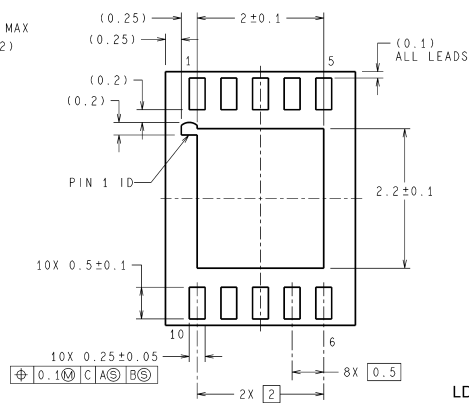
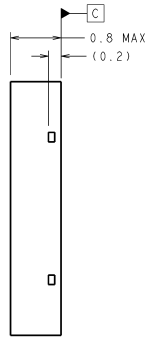
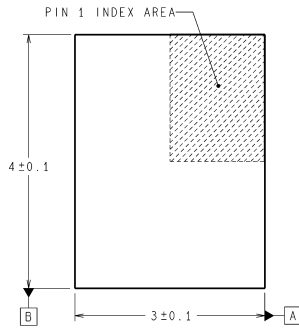

LDA10B (Rev B)

LLP
Order Number LM4898LD
NSPackage Number LDA10B

Physical Dimensions inches (millimeters) unless otherwise noted (Continued)

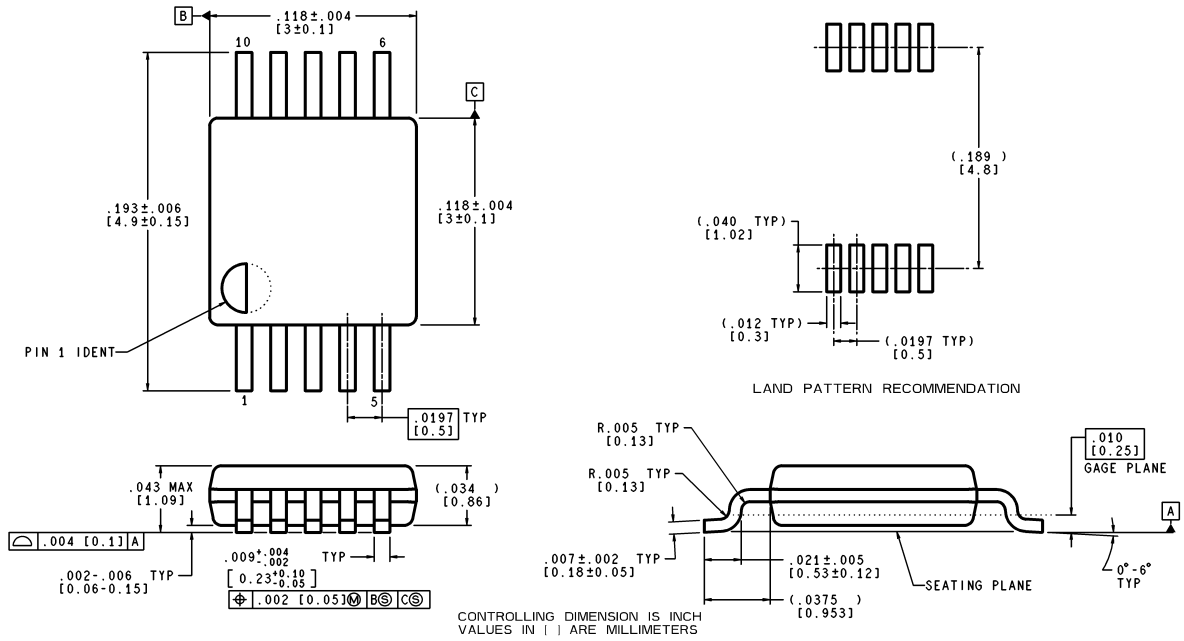

MUB10A (Rev A)

Mini Small Outline (MSOP)
Order Number LM4898MM
NSPackage Number MUB10A

Physical Dimensions inches (millimeters) unless otherwise noted (Continued)

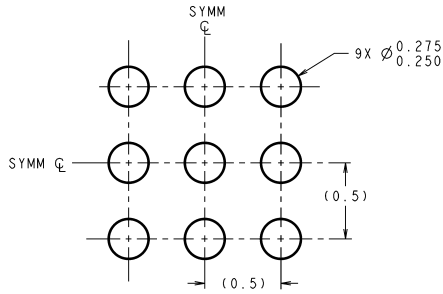

DIMENSIONS ARE IN MILLIMETERS

LAND PATTERN RECOMMENDATION

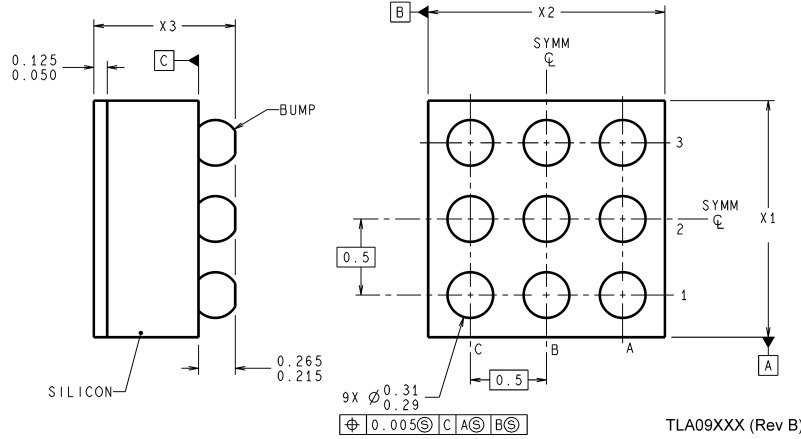
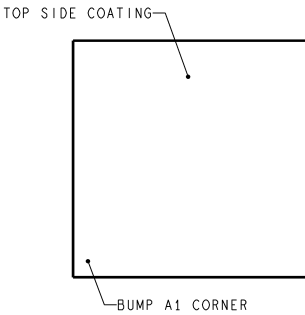

TLA09XXX (Rev B)

9-Bump micro SMD
Order Number LM4898ITL, LM4898ITLX
NS Package Number TLA09AAA
X1 = 1.514±0.03 X2 = 1.514±0.03 X3 = 0.600±0.075

LIFE SUPPORT POLICY

NATIONAL'S PRODUCTS ARE NOT AUTHORIZED FOR USE AS CRITICAL COMPONENTS IN LIFE SUPPORT DEVICES OR SYSTEMS WITHOUT THE EXPRESS WRITTEN APPROVAL OF THE PRESIDENT AND GENERAL COUNSEL OF NATIONAL SEMICONDUCTOR CORPORATION. As used herein:

1. Life support devices or systems are devices or systems which, (a) are intended for surgical implant into the body, or (b) support or sustain life, and whose failure to perform when properly used in accordance with instructions for use provided in the labeling, can be reasonably expected to result in a significant injury to the user.
2. A critical component is any component of a life support device or system whose failure to perform can be reasonably expected to cause the failure of the life support device or system, or to affect its safety or effectiveness.



National Semiconductor
Americas Customer Support Center
 Email: new.feedback@nsc.com
 Tel: 1-800-272-9959

National Semiconductor
Europe Customer Support Center
 Fax: +49 (0) 180-530 85 86
 Email: europe.support@nsc.com
 Deutsch Tel: +49 (0) 69 9508 6208
 English Tel: +44 (0) 870 24 0 2171
 Français Tel: +33 (0) 1 41 91 8790

National Semiconductor
Asia Pacific Customer Support Center
 Email: ap.support@nsc.com

National Semiconductor
Japan Customer Support Center
 Fax: 81-3-5639-7507
 Email: jpn.feedback@nsc.com
 Tel: 81-3-5639-7560

www.national.com