

LM4864 Boomer® Audio Power Amplifier Series

725mW Audio Power Amplifier with Shutdown Mode

General Description

The LM4864 is a bridged audio power amplifier capable of delivering 725mW of continuous average power into an 8Ω load with 1% THD+N from a 5V power supply.

Boomer® audio power amplifiers were designed specifically to provide high quality output power from a low supply voltage while requiring a minimal amount of external components. Since the LM4864 does not require output coupling capacitors, bootstrap capacitors or snubber networks, it is optimally suited for low-power portable applications.

The LM4864 features an externally controlled, low power consumption shutdown mode, and thermal shutdown protection.

The closed loop response of the unity-gain stable LM4864 can be configured by external gain-setting resistors. The device is available in multiple package types to suit various applications.

Key Specifications

- P_O at 1% THD+N with V_{DD} = 5V, 1kHz

LM4864LD, 4Ω load	625mW (typ)
LM4864LD, 8Ω load	725mW (typ)

- | | |
|-----------------------------|-------------|
| LM4864M & LM4864N*, 8Ω load | 675mW (typ) |
| LM4864MM, 8Ω load (Note 10) | 300mW (typ) |
| LM4864, 16Ω load | 550mW (typ) |
| ■ Shutdown current | 0.7μA (typ) |

* Not recommended for new designs. Contact NSC Audio Marketing.

Features

- MSOP, SOP, DIP*, and LD packaging
- No output coupling capacitors, bootstrap capacitors, or snubber circuits are necessary
- Thermal shutdown protection circuitry
- Unity-gain stable
- External gain configuration capability

* Not recommended for new designs. Contact NSC Audio Marketing.

Applications

- Cellular phones
- Personal computers
- General purpose audio

Typical Application

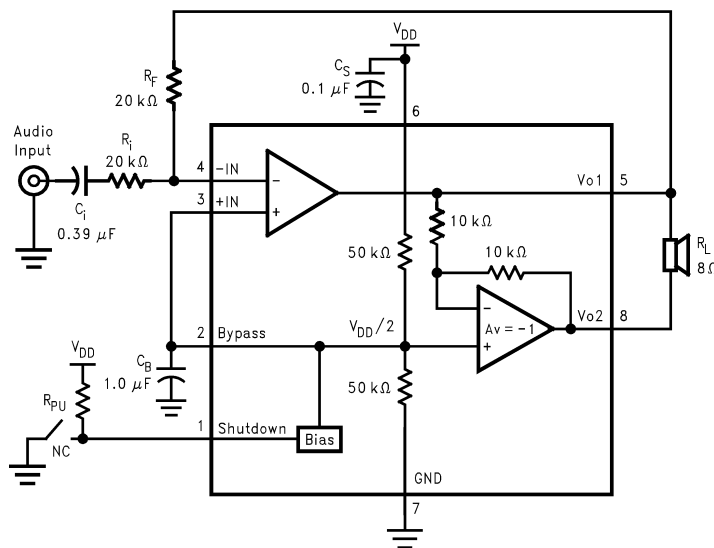
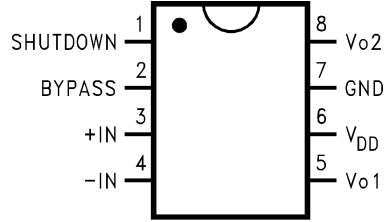

FIGURE 1. Typical Audio Amplifier Application Circuit

Boomer® is a registered trademark of National Semiconductor Corporation.

Connection Diagrams

MSOP, SOP, and DIP Package



01260702

Top View

Order Number LM4864MM,
LM4864M or LM4864N*
See NS Package Number MUA08A,
M08A or N08E*

* Not recommended for new designs. Contact NSC Audio Marketing

LD Package

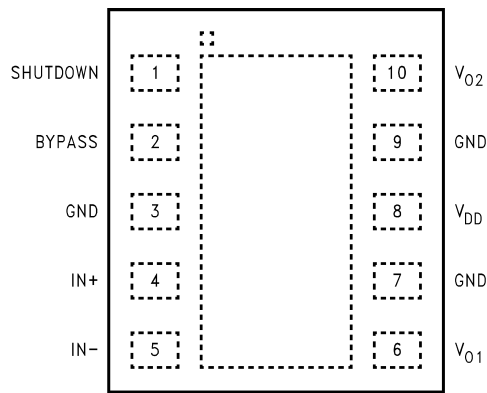

01260730

Top View

Order Number LM4864LD,
See NS Package Number LDA10A

DIE LAYOUT (B-STEP)

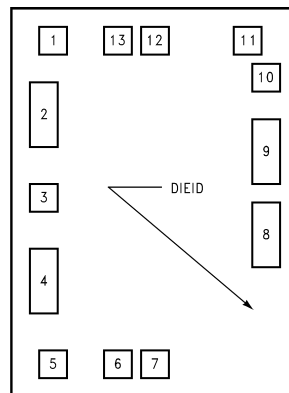

01260740

LM4864 MDC MWC
725MW AUDIO POWER AMPLIFIER WITH SHUTDOWN MODE

Absolute Maximum Ratings (Note 2)

If Military/Aerospace specified devices are required, please contact the National Semiconductor Sales Office/Distributors for availability and specifications.

Supply Voltage	6.0V
Storage Temperature	-65°C to +150°C
Input Voltage	-0.3V to $V_{DD} + 0.3V$
Power Dissipation (Note 3)	Internally limited
ESD Susceptibility (Note 4)	2000V
ESD Susceptibility (Note 5)	200V
Junction Temperature	150°C
Soldering Information	
Small Outline Package	
Vapor Phase (60 sec.)	215°C
Infrared (15 sec.)	220°C

See AN-450 "Surface Mounting and their Effects on Product Reliability" for other methods of soldering surface mount devices.

Thermal Resistance

θ_{JC} (MSOP)	56°C/W
θ_{JA} (MSOP)	210°C/W
θ_{JC} (SOP)	35°C/W
θ_{JA} (SOP)	170°C/W
θ_{JC} (DIP)*	37°C/W
θ_{JA} (DIP)*	107°C/W
θ_{JA} (LD) (Note 11)	63°C/W
θ_{JC} (LD) (Note 11)	12°C/W

* Not recommended for new designs. Contact NSC Audio Marketing.

Operating Ratings

Temperature Range

$T_{MIN} \leq T_A \leq T_{MAX}$	$-40^\circ\text{C} \leq T_A \leq +85^\circ\text{C}$
---------------------------------	---

Supply Voltage

$$2.7V \leq V_{DD} \leq 5.5V$$

Electrical Characteristics $V_{DD} = 5V$ (Note 1) (Note 2)

The following specifications apply for $V_{DD} = 5V$, for all available packages, unless otherwise specified. Limits apply for $T_A = 25^\circ\text{C}$

Symbol	Parameter	Conditions	LM4864		Units (Limits)
			Typical (Note 6)	Limit (Notes 7, 8)	
I_{DD}	Quiescent Power Supply Current	$V_{IN} = 0V, I_O = 0A$ (Note 9)	3.6	6.0	mA (max)
I_{SD}	Shutdown Current	$V_{PIN1} = V_{DD}$	0.7	5	μA (max)
V_{OS}	Output Offset Voltage	$V_{IN} = 0V$	5	50	mV (max)
P_O	Output Power	THD = 1% (max); f = 1 kHz; $R_L = 4\Omega$; LM4864LD (Note 11)	625		mW (min)
		THD = 1% (max); f = 1 kHz; $R_L = 8\Omega$; LM4864LD (Note 11)	725		mW (min)
		THD = 1% (max); f = 1 kHz; $R_L = 8\Omega$; LM4864MM (Note 10)		300	mW (min)
		THD = 1% (max); f = 1 kHz; $R_L = 8\Omega$; LM4864M and LM4864N*	675	300	mW (min)
		THD+N = 1%; f = 1 kHz; $R_L = 16\Omega$;	550		mW
THD+N	Total Harmonic Distortion+Noise	$P_O = 300 \text{ mWrms}; A_{VD} = 2; R_L = 8\Omega$; 20 Hz $\leq f \leq 20$ kHz, BW < 80kHz	0.7		%
PSRR	Power Supply Rejection Ratio	$V_{DD} = 4.9V-5.1V$	50		dB

* Not recommended for new designs. Contact NSC Audio Marketing.

Electrical Characteristics $V_{DD} = 3V$ (Note 1) (Note 2)

The following specifications apply for $V_{DD} = 3V$, for all available packages, unless otherwise specified. Limits apply for $T_A = 25^\circ\text{C}$

Symbol	Parameter	Conditions	LM4864		Units (Limits)
			Typical (Note 6)	Limit (Notes 7, 8)	
I_{DD}	Quiescent Power Supply Current	$V_{IN} = 0V, I_O = 0A$ (Note 9)	1.0	3.0	mA (max)
I_{SD}	Shutdown Current	$V_{PIN1} = V_{DD}$	0.3	2.0	μA (max)

Electrical Characteristics $V_{DD} = 3V$ (Note 1) (Note 2) (Continued)

The following specifications apply for $V_{DD} = 3V$, for all available packages, unless otherwise specified. Limits apply for $T_A = 25^\circ C$

Symbol	Parameter	Conditions	LM4864		Units (Limits)
			Typical (Note 6)	Limit (Notes 7, 8)	
V_{OS}	Output Offset Voltage	$V_{IN} = 0V$	5		mV
P_O	Output Power	THD = 1% (max); f = 1 kHz; $R_L = 8\Omega$	200		mW
		THD = 1% (max); f = 1 kHz; $R_L = 16\Omega$	175		mW
THD+N	Total Harmonic Distortion+Noise	$P_O = 100 \text{ mWrms}$; $A_{VD} = 2$; $R_L = 8\Omega$; $20 \text{ Hz} \leq f \leq 20 \text{ kHz}$, BW < 80 kHz	1.5		%
PSRR	Power Supply Rejection Ratio	$V_{DD} = 2.9V-3.1V$	50		dB

Note 1: All voltages are measured with respect to the ground pin, unless otherwise specified.

Note 2: Absolute Maximum Ratings indicate limits beyond which damage to the device may occur. Operating Ratings indicate conditions for which the device is functional, but do not guarantee specific performance limits. Electrical Characteristics state DC and AC electrical specifications under particular test conditions which guarantee specific performance limits. This assumes that the device is within the Operating Ratings. Specifications are not guaranteed for parameters where no limit is given, however, the typical value is a good indication of device performance.

Note 3: The maximum power dissipation must be derated at elevated temperatures and is dictated by T_{JMAX} , θ_{JA} , and the ambient temperature T_A . The maximum allowable power dissipation is $P_{DMAX} = (T_{JMAX} - T_A)/\theta_{JA}$ or the number given in the Absolute Maximum Ratings, whichever is lower. For the LM4864, $T_{JMAX} = 150^\circ C$. The typical junction-to-ambient thermal resistance, when board mounted, is $230^\circ C/W$ for package number MUA08A, $170^\circ C/W$ for package number M08A and is $107^\circ C/W$ for package number N08E.

Note 4: Human body model, 100pF discharged through a 1.5k Ω resistor.

Note 5: Machine Model, 220pF – 240pF discharged through all pins.

Note 6: Typicals are measured at $25^\circ C$ and represent the parametric norm.

Note 7: Limits are guaranteed to National's AOQL (Average Outgoing Quality Level).

Note 8: Datasheet min/max specification limits are guaranteed by design, test, or statistical analysis.

Note 9: The quiescent power supply current depends on the offset voltage when a practical load is connected to the amplifier.

Note 10: The MUA08BA package is thermally limited to 595 mW of power dissipation at room temperature. Referring to the Power Dissipation vs Output Power graph in the **Typical Performance Characteristics** section, the power dissipation limitation for the package occurs at 300 mW of output power. This package limitation is based on $25^\circ C$ ambient temperature and $\theta_{JA} = 210^\circ C$. For higher output power possibilities refer to the **Power Dissipation** Section.

Note 11: The LDA10A package has its exposed-DAP soldered to an exposed 1.2in² area of 1oz printed circuit board copper.

* Not recommended for new designs. Contact NSC Audio Marketing.

External Components Description *(Figure 1)*

Components		Functional Description
1.	R_i	Inverting input resistance which sets the closed-loop gain in conjunction with R_F . This resistor also forms a high pass filter with C_i at $f_c = 1/(2\pi R_i C_i)$.
2.	C_i	Input coupling capacitor which blocks the DC voltage at the amplifier's input terminals. Also creates a highpass filter with R_i at $f_c = 1/(2\pi R_i C_i)$. Refer to the section, Proper Selection of External Components , for an explanation of how to determine the value of C_i .
3.	R_F	Feedback resistance which sets the closed-loop gain in conjunction with R_i .
4.	C_S	Supply bypass capacitor which provides power supply filtering. Refer to the Power Supply Bypassing section for information concerning proper placement and selection of the supply bypass capacitor.
5.	C_B	Bypass pin capacitor which provides half-supply filtering. Refer to the Proper Selection of External Components for information concerning proper placement and selection of C_B .

Typical Performance Characteristics

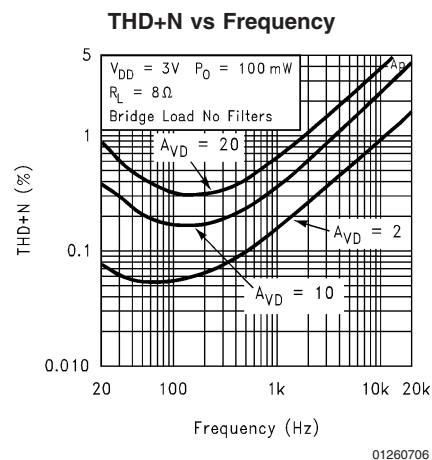
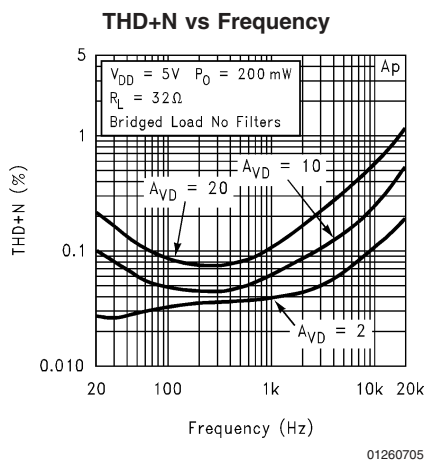
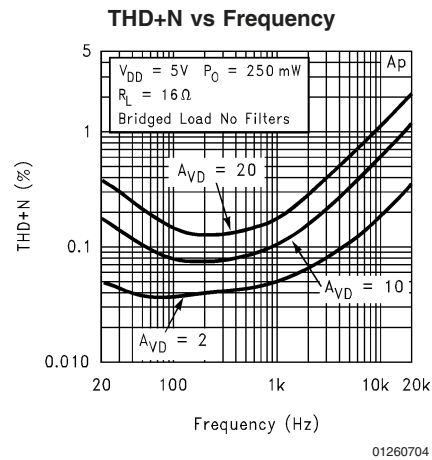
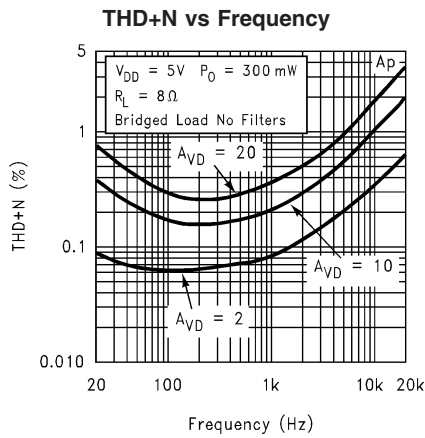

Typical Performance Characteristics (Continued)

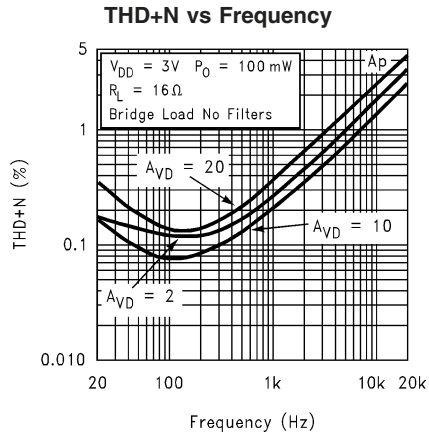

01260707

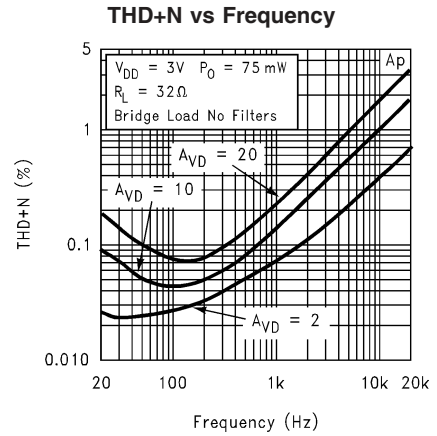

01260708

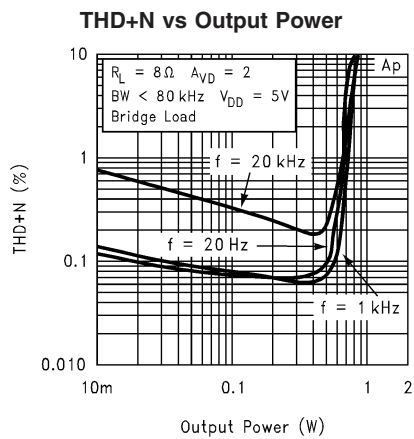

01260709

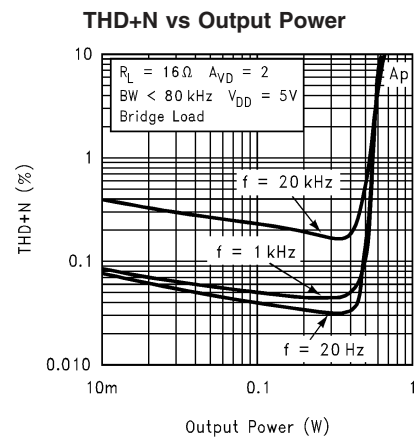

01260710

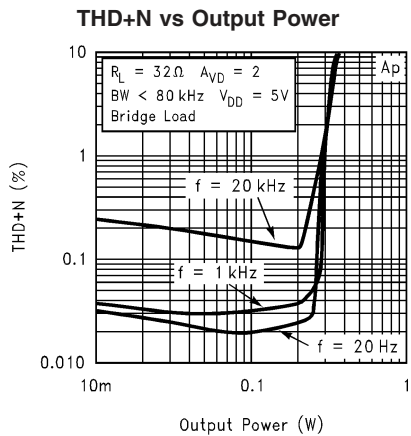

01260711

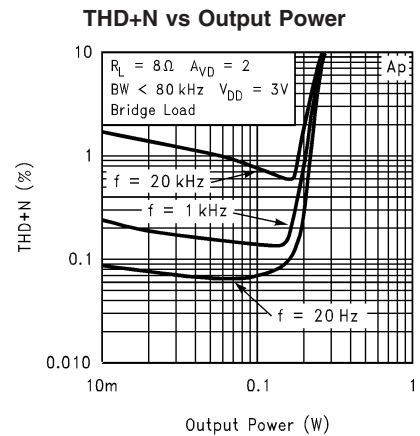

01260712

Typical Performance Characteristics (Continued)

THD+N vs Output Power

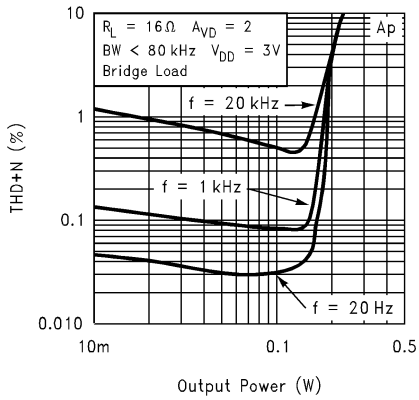

01260713

THD+N vs Output Power

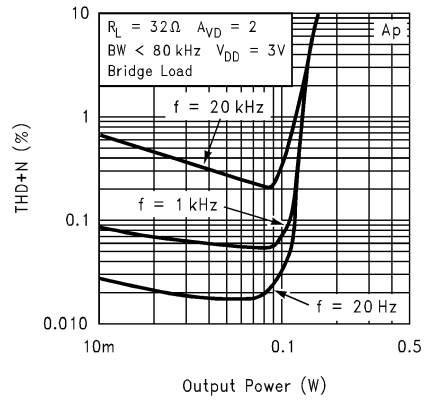

01260714

Output Power vs Supply Voltage

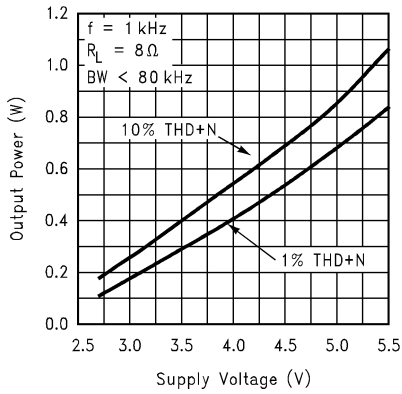

01260715

Output Power vs Supply Voltage

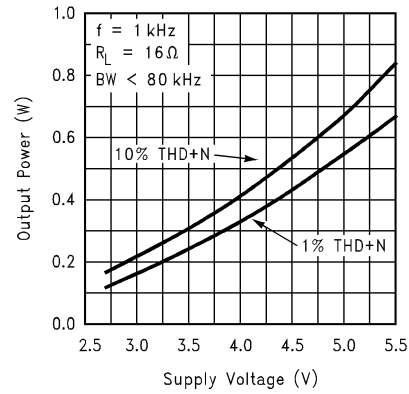

01260716

Output Power vs Supply Voltage

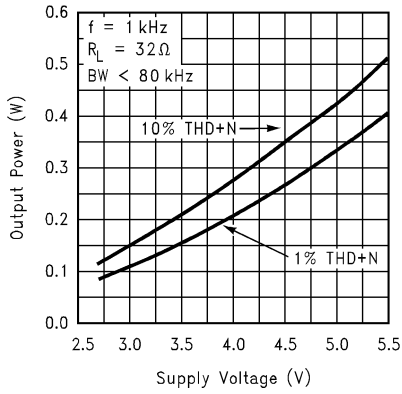

01260717

Output Power vs Load Resistance

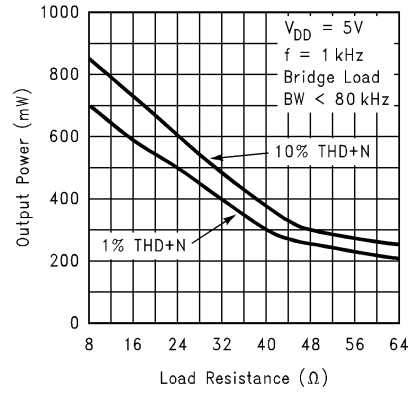

01260718

Typical Performance Characteristics (Continued)

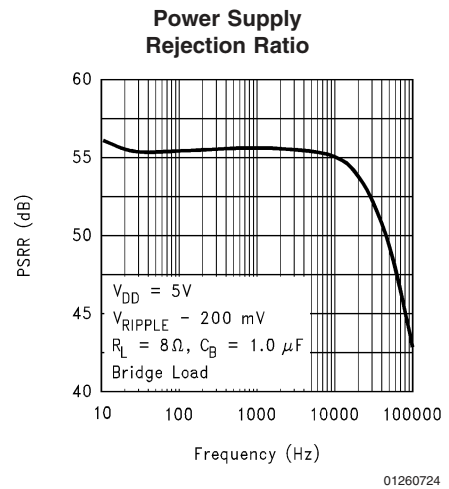
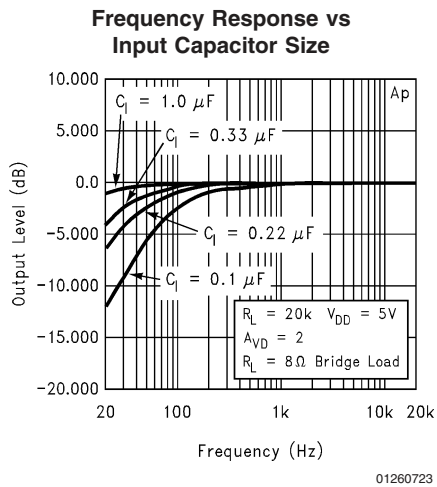
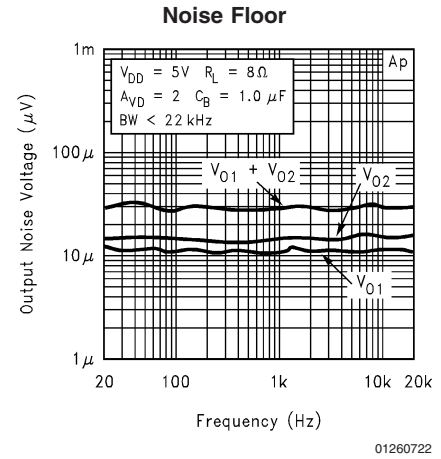
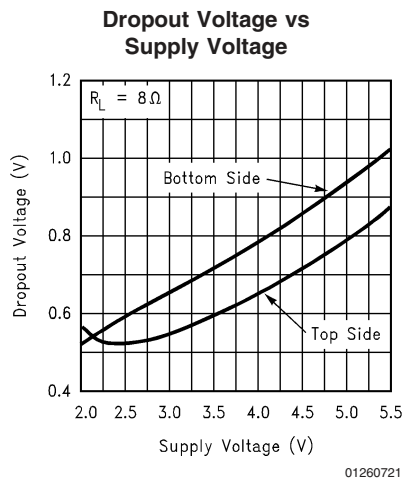
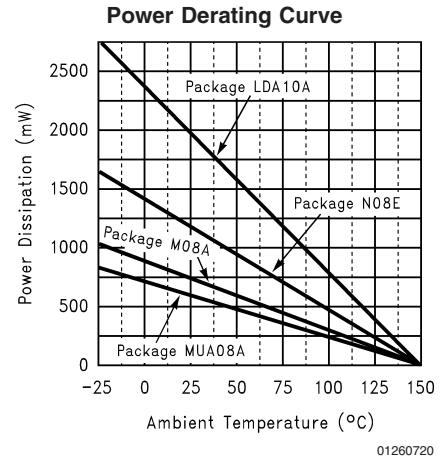
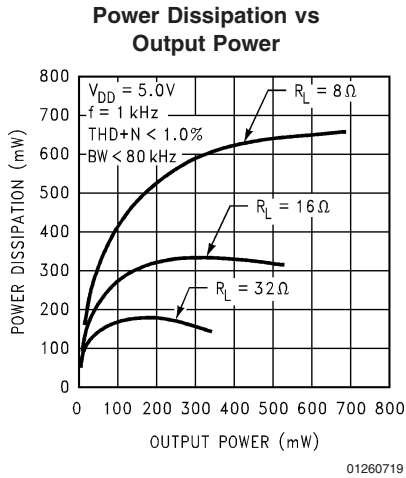

Typical Performance Characteristics (Continued)

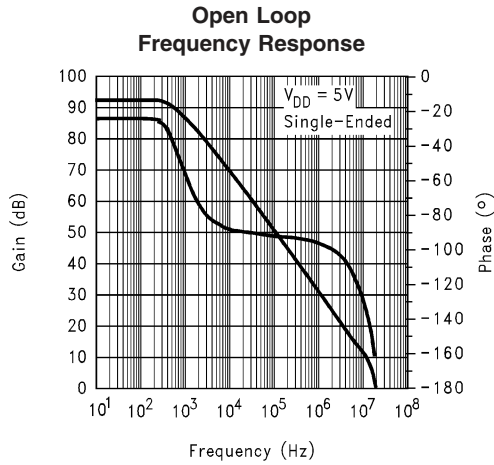

01260725

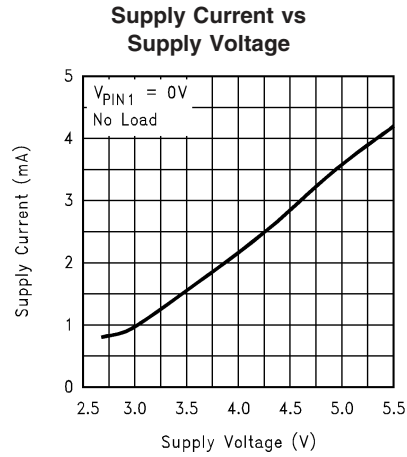

01260726

Typical Performance Characteristics for the LM4864LD (Note 11)

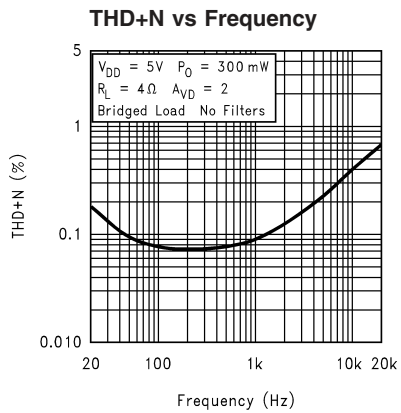

01260731

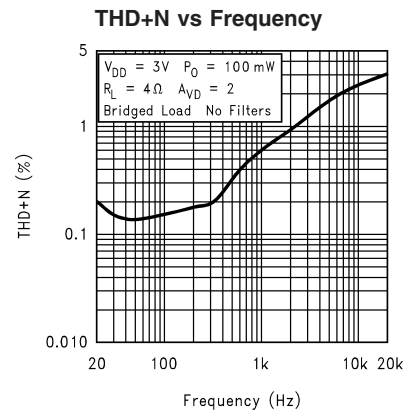

01260732

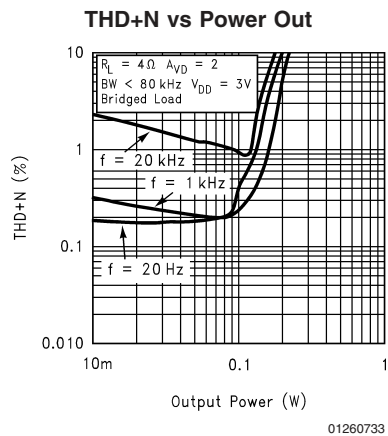

01260733

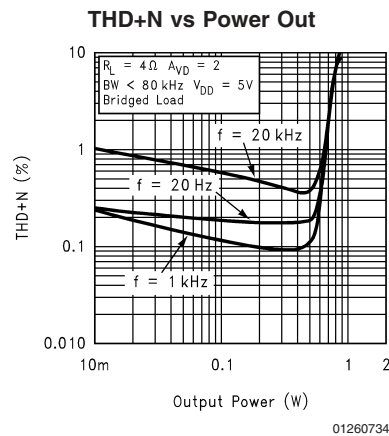

01260734

Typical Performance Characteristics for the LM4864LD (Note 11) (Continued)

Output Power vs Supply Voltage

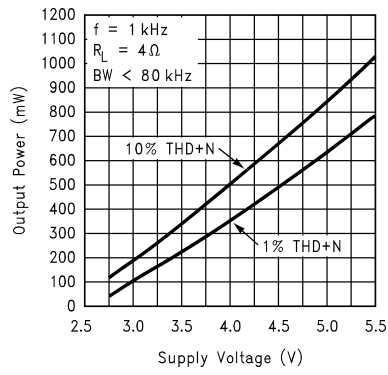

Power Dissipation vs Output Power

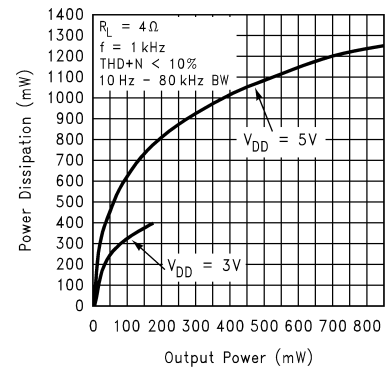

Application Information

BRIDGE CONFIGURATION EXPLANATION

As shown in *Figure 1*, the LM4864 has two operational amplifiers internally, allowing for a few different amplifier configurations. The first amplifier's gain is externally configurable, while the second amplifier is internally fixed in a unity-gain, inverting configuration. The closed-loop gain of the first amplifier is set by selecting the ratio of R_F to R_i while the second amplifier's gain is fixed by the two internal 10k Ω resistors. *Figure 1* shows that the output of amplifier one serves as the input to amplifier two which results in both amplifiers producing signals identical in magnitude, but out of phase 180°. Consequently, the differential gain for the IC is

$$A_{VD} = 2 \cdot (R_F/R_i)$$

By driving the load differentially through outputs V_{o1} and V_{o2} , an amplifier configuration commonly referred to as "bridged mode" is established. Bridged mode operation is different from the classical single-ended amplifier configuration where one side of its load is connected to ground.

A bridge amplifier design has a few distinct advantages over the single-ended configuration, as it provides differential drive to the load, thus doubling output swing for a specified supply voltage. Four times the output power is possible as compared to a single-ended amplifier under the same conditions. This increase in attainable output power assumes that the amplifier is not current limited or clipped. In order to choose an amplifier's closed-loop gain without causing excessive clipping, please refer to the **Audio Power Amplifier Design** section.

A bridge configuration, such as the one used in LM4864, also creates a second advantage over single-ended amplifiers. Since the differential outputs, V_{o1} and V_{o2} , are biased at half-supply, no net DC voltage exists across the load. This eliminates the need for an output coupling capacitor which is required in a single supply, single-ended amplifier configuration. If an output coupling capacitor is not used in a single-ended configuration, the half-supply bias across the load would result in both increased internal IC power dissipation as well as permanent loudspeaker damage.

POWER DISSIPATION

Power dissipation is a major concern when designing a successful amplifier, whether the amplifier is bridged or single-ended. Equation 1 states the maximum power dissipation point for a bridge amplifier operating at a given supply voltage and driving a specified output load.

$$P_{DMAX} = (V_{DD})^2 / (2\pi^2 R_L) \quad \text{Single-Ended (1)}$$

However, a direct consequence of the increased power delivered to the load by a bridge amplifier is an increase in internal power dissipation point for a bridge amplifier operating at the same conditions.

$$P_{DMAX} = 4(V_{DD})^2 / (2\pi^2 R_L) \quad \text{Bridge Mode (2)}$$

Since the LM4864 has two operational amplifiers in one package, the maximum internal power dissipation is 4 times that of a single-ended amplifier. Even with this substantial increase in power dissipation, the LM4864 does not require heatsinking. From Equation 1, assuming a 5V power supply and an 8 Ω load, the maximum power dissipation point is 633 mW. The maximum power dissipation point obtained from Equation 2 must not be greater than the power dissipation that results from Equation 3:

$$P_{DMAX} = (T_{JMAX} - T_A) / \theta_{JA} \quad (3)$$

For package MUA08A, $\theta_{JA} = 210^\circ\text{C/W}$, for package M08A, $\theta_{JA} = 170^\circ\text{C/W}$, for package N08E, $\theta_{JA} = 107^\circ\text{C/W}$, and for package LDA10A, $\theta_{JA} = 63^\circ\text{C/W}$. $T_{JMAX} = 150^\circ\text{C}$ for the LM4864. Depending on the ambient temperature, T_A , of the system surroundings, Equation 3 can be used to find the maximum internal power dissipation supported by the IC packaging. If the result of Equation 2 is greater than that of Equation 3, then either the supply voltage must be decreased, the load impedance increased, the ambient temperature reduced, or the θ_{JA} reduced with heatsinking. In many cases larger traces near the output, V_{DD} , and GND pins can be used to lower the θ_{JA} . The larger areas of copper provide a form of heatsinking allowing a higher power dissipation. For the typical application of a 5V power supply, with an 8 Ω load, the maximum ambient temperature possible without violating the maximum junction temperature is approximately 44°C provided that device operation is around the maximum power dissipation point and assuming surface mount packaging. Internal power dissipation is a function of output power. If typical operation is not around the maximum power dissipation point, the ambient temperature can be increased. Refer to the **Typical Performance Characteristics** curves for power dissipation information for lower output powers.

EXPOSED-DAP PACKAGE PCB MOUNTING CONSIDERATION

The LM4864's exposed-dap (die attach paddle) package (LD) provides a low thermal resistance between the die and the PCB to which the part is mounted and soldered. This allows rapid heat transfer from the die to the surrounding PCB copper traces, ground plane, and surrounding air.

The LD package should have its DAP soldered to a copper pad on the PCB. The DAP's PCB copper pad may be connected to a large plane of continuous unbroken copper. This plane forms a thermal mass, heat sink, and radiation area.

Further detailed and specific information concerning PCB layout, fabrication, and mounting an LD (LLP) package is available from National Semiconductor's Package Engineering Group under application note AN1187.

POWER SUPPLY BYPASSING

As with any power amplifier, proper supply bypassing is critical for low noise performance and high power supply rejection. The capacitor location on both the bypass and power supply pins should be as close to the device as possible. The effect of a larger half supply bypass capacitor is improved PSRR due to increased half-supply stability. Typical applications employ a 5V regulator with 10 μF and a 0.1 μF bypass capacitors which aid in supply stability, but do not eliminate the need for bypassing the supply nodes of the LM4864. The selection of bypass capacitors, especially C_B , is thus dependent upon desired PSRR requirements, click and pop performance as explained in the section, **Proper Selection of External Components**, system cost, and size constraints.

SHUTDOWN FUNCTION

In order to reduce power consumption while not in use, the LM4864 contains a shutdown pin to externally turn off the amplifier's bias circuitry. This shutdown feature turns the amplifier off when a logic high is placed on the shutdown pin. The trigger point between a logic low and logic high level is typically half supply. It is best to switch between ground and supply to provide maximum device performance. By switching the shutdown pin to V_{DD} , the LM4864 supply current

Application Information (Continued)

draw will be minimized in idle mode. While the device will be disabled with shutdown pin voltages less than V_{DD} , the idle current may be greater than the typical value of $0.7 \mu\text{A}$. In either case, the shutdown pin should be tied to a definite voltage to avoid unwanted state changes.

In many applications, a microcontroller or microprocessor output is used to control the shutdown circuitry which provides a quick, smooth transition into shutdown. Another solution is to use a single-pole, single-throw switch in conjunction with an external pull-up resistor. When the switch is closed, the shutdown pin is connected to ground and enables the amplifier. If the switch is open, then the external pull-up resistor will disable the LM4864. This scheme guarantees that the shutdown pin will not float, thus preventing unwanted state changes.

PROPER SELECTION OF EXTERNAL COMPONENTS

Proper selection of external components in applications using integrated power amplifiers is critical to optimize device and system performance. While the LM4864 is tolerant to a variety of external component combinations, consideration to component values must be used to maximize overall system quality.

The LM4864 is unity-gain stable, giving a designer maximum system flexibility. The LM4864 should be used in low gain configurations to minimize THD+N values, and maximize the signal to noise ratio. Low gain configurations require large input signals to obtain a given output power. Input signals equal to or greater than 1 V_{rms} are available from sources such as audio codecs. Please refer to the section, **Audio Power Amplifier Design**, for a more complete explanation of proper gain selection.

Besides gain, one of the major considerations is the closed-loop bandwidth of the amplifier. To a large extent, the bandwidth is dictated by the choice of external components shown in *Figure 1*. The input coupling capacitor, C_i , forms a first order high pass filter which limits low frequency response. This value should be chosen based on needed frequency response for a few distinct reasons.

Selection of Input Capacitor Size

Large input capacitors are both expensive and space hungry for portable designs. Clearly, a certain sized capacitor is needed to couple in low frequencies without severe attenuation. But in many cases the speakers used in portable systems, whether internal or external, have little ability to reproduce signals below 150 Hz. In this case using a large input capacitor may not increase system performance.

In addition to system cost and size, click and pop performance is effected by the size of the input coupling capacitor, C_i . A larger input coupling capacitor requires more charge to reach its quiescent DC voltage (nominally $\frac{1}{2} V_{DD}$). This charge comes from the output via the feedback and is apt to create pops upon device enable. Thus, by minimizing the capacitor size based on necessary low frequency response, turn-on pops can be minimized.

Besides minimizing the input capacitor size, careful consideration should be paid to the bypass capacitor value. Bypass capacitor, C_B , is the most critical component to minimize turn-on pops since it determines how fast the LM4864 turns on. The slower the LM4864's outputs ramp to their quiescent DC voltage (nominally $\frac{1}{2} V_{DD}$), the smaller the turn-on pop. Choosing C_B equal to $1.0 \mu\text{F}$ along with a small value of C_i (in the range of $0.1 \mu\text{F}$ to $0.39 \mu\text{F}$), should produce a click-

less and popless shutdown function. While the device will function properly, (no oscillations or motorboating), with C_B equal to $0.1 \mu\text{F}$, the device will be much more susceptible to turn-on clicks and pops. Thus, a value of C_B equal to $1.0 \mu\text{F}$ or larger is recommended in all but the most cost sensitive designs.

AUDIO POWER AMPLIFIER DESIGN

Design a 300 mW/8Ω Audio Amplifier

Given:

Power Output	300 mW _{rms}
Load Impedance	8Ω
Input Level	1 V _{rms}
Input Impedance	20 kΩ
Bandwidth	100 Hz–20 kHz ± 0.25 dB

A designer must first determine the minimum supply rail to obtain the specified output power. By extrapolating from the Output Power vs Supply Voltage graphs in the **Typical Performance Characteristics** section, the supply rail can be easily found. A second way to determine the minimum supply rail is to calculate the required V_{opeak} using Equation 4 and add the dropout voltage. Using this method, the minimum supply voltage would be $(V_{\text{opeak}} + (2 \cdot V_{\text{OD}}))$, where V_{OD} is extrapolated from the Dropout Voltage vs Supply Voltage curve in the **Typical Performance Characteristics** section.

$$V_{\text{opeak}} = \sqrt{(2R_L P_O)} \quad (4)$$

Using the Output Power vs Supply Voltage graph for an 8Ω load, the minimum supply rail is 3.5V. But since 5V is a standard supply voltage in most applications, it is chosen for the supply rail. Extra supply voltage creates headroom that allows the LM4864 to reproduce peaks in excess of 500 mW without producing audible distortion. At this time, the designer must make sure that the power supply choice along with the output impedance does not violate the conditions explained in the **Power Dissipation** section.

Once the power dissipation equations have been addressed, the required differential gain can be determined from Equation 5.

$$A_{VD} \geq \sqrt{(P_O R_L)} / (V_{IN}) = V_{\text{orms}} / V_{\text{inrms}} \quad (5)$$

$$R_F / R_i = A_{VD} / 2 \quad (6)$$

From Equation 5, the minimum A_{VD} is 1.55; use $A_{VD} = 2$.

Since the desired input impedance was $20 \text{ k}\Omega$, and with a A_{VD} of 2, a ratio of 1:1 of R_F to R_i results in an allocation of $R_i = R_F = 20 \text{ k}\Omega$. The final design step is to address the bandwidth requirements which must be stated as a pair of -3 dB frequency points. Five times away from a pole gives 0.17 dB down from passband response which is better than the required $\pm 0.25 \text{ dB}$ specified.

$$f_L = 100 \text{ Hz} / 5 = 20 \text{ Hz}$$

$$f_H = 20 \text{ kHz} \times 5 = 100 \text{ kHz}$$

As stated in the **External Components** section, R_i in conjunction with C_i create a highpass filter.

$$C_i \geq \frac{1}{2\pi R_i f_c}$$

$$C_i \geq 1 / (2\pi \cdot 20 \text{ k}\Omega \cdot 20 \text{ Hz}) = 0.397 \mu\text{F}; \text{ use } 0.39 \mu\text{F}$$

Application Information (Continued)

The high frequency pole is determined by the product of the desired high frequency pole, f_H , and the differential gain, A_{VD} . With a $A_{VD} = 2$ and $f_H = 100$ kHz, the resulting GBWP

= 100 kHz which is much smaller than the LM4864 GBWP of 18 MHz. This figure displays that if a designer has a need to design an amplifier with a higher differential gain, the LM4864 can still be used without running into bandwidth problems.

LM4864LD DEMO BOARD ARTWORK

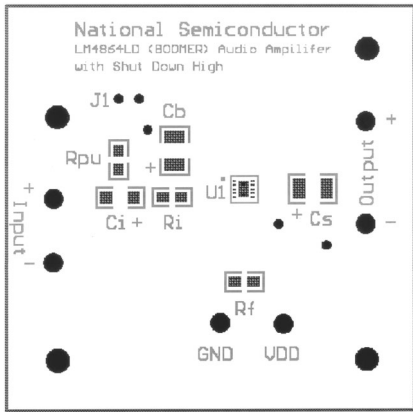

01260737

Silk Screen View of LM4864LD

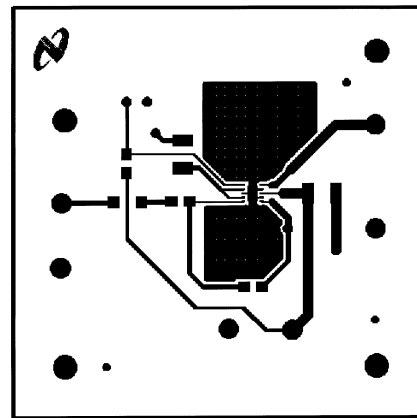

01260738

Top Layer of LM4864LD

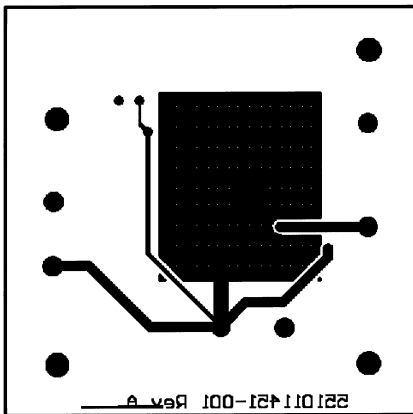

01260739

Bottom Layer of LM4864LD

LM4864 MDC MWC 725MW Audio Power Amplifier With Shutdown Mode

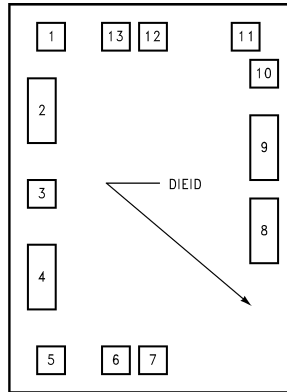

01260740

Die Layout (B - Step)

DIE/WAFER CHARACTERISTICS

Fabrication Attributes		General Die Information	
Physical Die Identification	LM4862B	Bond Pad Opening Size (min)	86 μ m x 86 μ m
Die Step	B	Bond Pad Metalization	ALUMINUM
Physical Attributes		Passivation	NITRIDE
Wafer Diameter	150mm	Back Side Metal	Bare Back
Dise Size (Drawn)	1283 μ m x 952 μ m 51mils x 37mils	Back Side Connection	GND
Thickness	406 μ m Nominal		
Min Pitch	117 μ m Nominal		

Special Assembly Requirements:**Note: Actual die size is rounded to the nearest micron.**

Die Bond Pad Coordinate Locations (B - Step)

(Referenced to die center, coordinates in μ m) NC = No Connection

SIGNAL NAME	PAD# NUMBER	X/Y COORDINATES		PAD SIZE		
		X	Y	X		Y
BYPASS	1	-322	523	86	x	86
GND	2	-359	259	86	x	188
INPUT +	3	-359	5	86	x	86
GND	4	-359	-259	86	x	188
NC	5	-323	-523	86	x	86
INPUT -	6	-109	-523	86	x	86
VOUT 1	7	8	-523	86	x	86
VDD	8	358	-78	86	x	188
GND	9	358	141	86	x	188
NC	10	359	406	86	x	86
NC	11	323	523	86	x	86
VOUT 2	12	8	523	86	x	86
SHUTDOWN	13	-109	523	86	x	86

LM4864 MDC MWC
725MW Audio Power Amplifier With Shutdown Mode (Continued)

IN U.S.A	
Tel #:	1 877 Dial Die 1 877 342 5343
Fax:	1 207 541 6140
IN EUROPE	
Tel:	49 (0) 8141 351492 / 1495
Fax:	49 (0) 8141 351470
IN ASIA PACIFIC	
Tel:	(852) 27371701
IN JAPAN	
Tel:	81 043 299 2308

Physical Dimensions inches (millimeters) unless otherwise noted

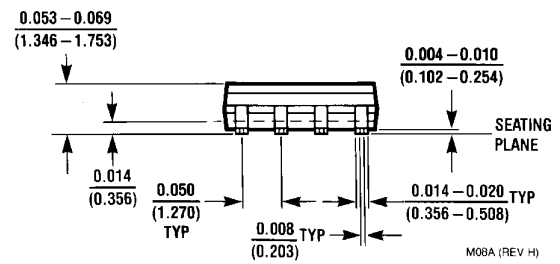
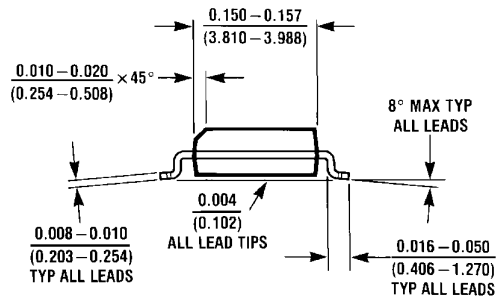
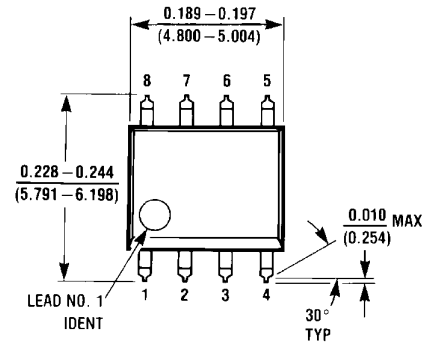

8-Lead (0.150" Wide) Molded Small Outline Package, JEDEC
Order Number LM4864M
NS Package Number M08A

Physical Dimensions inches (millimeters) unless otherwise noted (Continued)

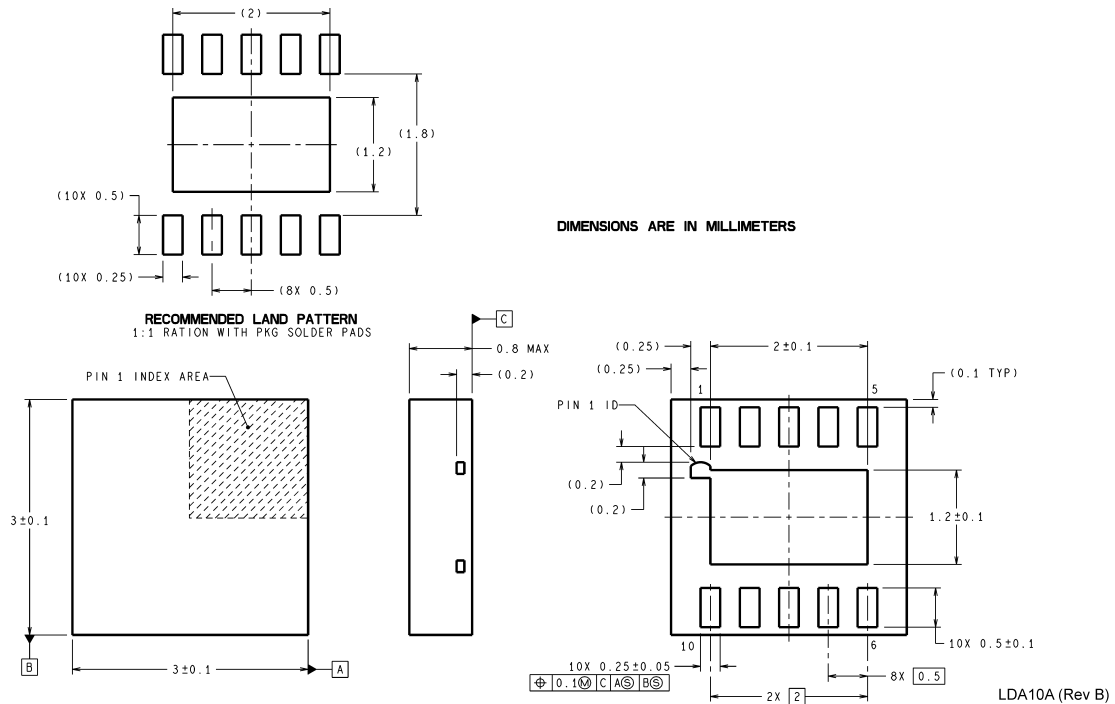

Order Number LM4864LD
NS Package Number LDA10A

LIFE SUPPORT POLICY

NATIONAL'S PRODUCTS ARE NOT AUTHORIZED FOR USE AS CRITICAL COMPONENTS IN LIFE SUPPORT DEVICES OR SYSTEMS WITHOUT THE EXPRESS WRITTEN APPROVAL OF THE PRESIDENT AND GENERAL COUNSEL OF NATIONAL SEMICONDUCTOR CORPORATION. As used herein:

1. Life support devices or systems are devices or systems which, (a) are intended for surgical implant into the body, or (b) support or sustain life, and whose failure to perform when properly used in accordance with instructions for use provided in the labeling, can be reasonably expected to result in a significant injury to the user.
2. A critical component is any component of a life support device or system whose failure to perform can be reasonably expected to cause the failure of the life support device or system, or to affect its safety or effectiveness.

BANNED SUBSTANCE COMPLIANCE

National Semiconductor certifies that the products and packing materials meet the provisions of the Customer Products Stewardship Specification (CSP-9-111C2) and the Banned Substances and Materials of Interest Specification (CSP-9-111S2) and contain no "Banned Substances" as defined in CSP-9-111S2.



National Semiconductor
Americas Customer
Support Center
Email: new.feedback@nsc.com
Tel: 1-800-272-9959

National Semiconductor
Europe Customer Support Center
Fax: +49 (0) 180-530 85 86
Email: europe.support@nsc.com
Deutsch Tel: +49 (0) 69 9508 6208
English Tel: +44 (0) 870 24 0 2171
Français Tel: +33 (0) 1 41 91 8790

National Semiconductor
Asia Pacific Customer
Support Center
Email: ap.support@nsc.com

National Semiconductor
Japan Customer Support Center
Fax: 81-3-5639-7507
Email: jpn.feedback@nsc.com
Tel: 81-3-5639-7560

www.national.com

National does not assume any responsibility for use of any circuitry described, no circuit patent licenses are implied and National reserves the right at any time without notice to change said circuitry and specifications.